

Holder for 4 modules, metal, for selector switch with 4 switch positions and for coordinate switch

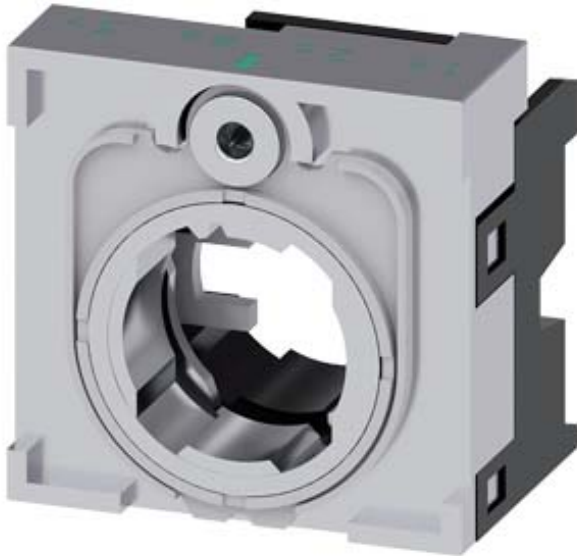

Product brand name	SIRIUS ACT
Product designation	Holders
Product type designation	3SU1
Manufacturer's article number	
<ul style="list-style-type: none"> of the supplied holder 	3SU1550-0AA10-0AA0
Actuator	
Design of the operating mechanism	4-way without module
Number of contact modules	0
Holder	
Material of the holder	Metal
Display	
Number of LED modules	0
General technical data	
Product function	
<ul style="list-style-type: none"> positive opening 	No
Product component	
<ul style="list-style-type: none"> diode lamp transformer 	No

<ul style="list-style-type: none"> • Light source 	No
<ul style="list-style-type: none"> • series resistor 	No
Insulation voltage	
<ul style="list-style-type: none"> • rated value 	500 V
Degree of pollution	3
Surge voltage resistance rated value	6 kV
Shock resistance	
<ul style="list-style-type: none"> • acc. to IEC 60068-2-27 • for railway applications acc. to DIN EN 61373 	Sinusoidal half-wave 50 g / 11 ms Category 1, Class B
Mechanical service life (switching cycles)	
<ul style="list-style-type: none"> • typical 	10
Reference code acc. to DIN EN 81346-2	U
Reference code acc. to DIN EN 61346-2	U

Auxiliary circuit

Number of NC contacts for auxiliary contacts	0
Number of NO contacts for auxiliary contacts	0
Number of CO contacts	
<ul style="list-style-type: none"> • for auxiliary contacts 	0

Connections/Terminals

Tightening torque of the screws in the bracket	1 ... 1.2 N·m
Tightening torque	
<ul style="list-style-type: none"> • for grounding 	0.8 ... 1 N·m





Ambient conditions

Ambient temperature	
<ul style="list-style-type: none"> • during operation • during storage 	-25 ... +70 °C -40 ... +80 °C
Environmental category during operation acc. to IEC 60721	3M6, 3S2, 3B2, 3C3, 3K6 (with relative air humidity of 10 ... 95 %, no condensation in operation permitted)

Installation/ mounting/ dimensions





<ul style="list-style-type: none"> • (mounting type) • Mounting type of modules and accessories 	without Front plate mounting
(height)	40 mm
Width	40 mm
Shape of the installation opening	round
Installation width	40 mm
Installation depth	32.1 mm

Certificates/approvals

General Product Approval	Declaration of Conformity	Test Certificates	Marine / Shipping
 CSA		 EG-Konf.	 ABS

[Miscellaneous](#)

[Type Test Certificates/Test Report](#)

Marine / Shipping	other
 LRS  PRS  RINA  RMRS  DNV-GL DNVGL.COM/AF	Confirmation

Further information

Information- and Downloadcenter (Catalogs, Brochures,...)

<http://www.siemens.com/industrial-controls/catalogs>

Industry Mall (Online ordering system)

<https://mall.industry.siemens.com/mall/en/en/Catalog/product?mlfb=3SU1550-0BA10-0AA0>

Cax online generator

<http://support.automation.siemens.com/WW/CAXorder/default.aspx?lang=en&mlfb=3SU1550-0BA10-0AA0>

Service&Support (Manuals, Certificates, Characteristics, FAQs,...)

<https://support.industry.siemens.com/cs/ww/en/ps/3SU1550-0BA10-0AA0>

Image database (product images, 2D dimension drawings, 3D models, device circuit diagrams, EPLAN macros, ...)

http://www.automation.siemens.com/bilddb/cax_de.aspx?mlfb=3SU1550-0BA10-0AA0&lang=en

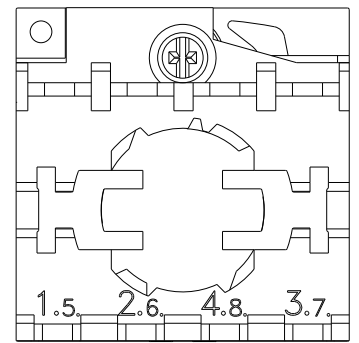
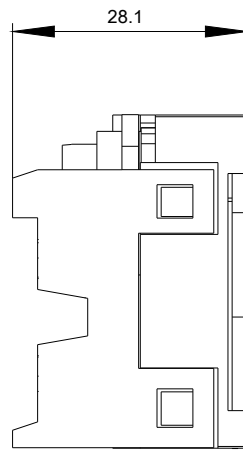
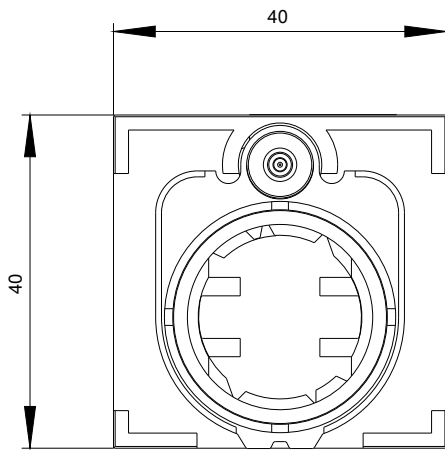

last modified:

07/26/2019