

back view

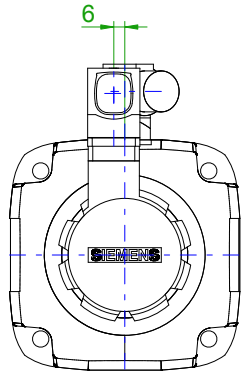

front view

center hole
DIN 332-DR M8

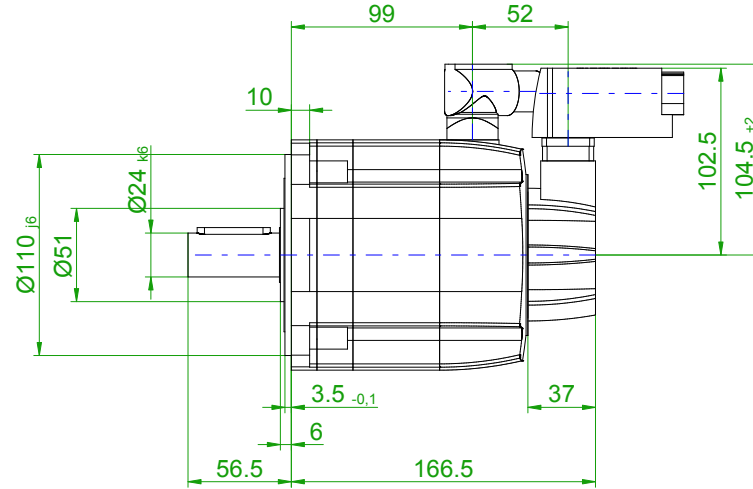
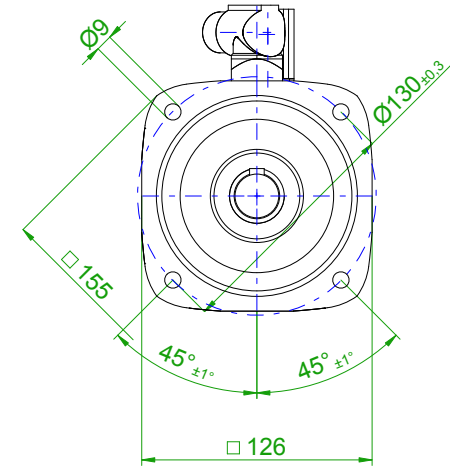

version with featherkey

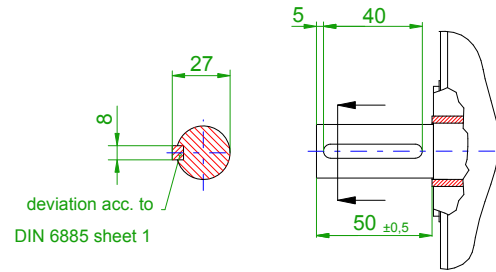

6-pole plug size 1
for power

10-pole
signal plug

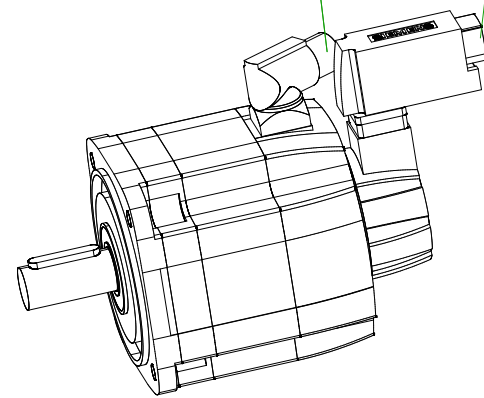

rotating angle of the plug

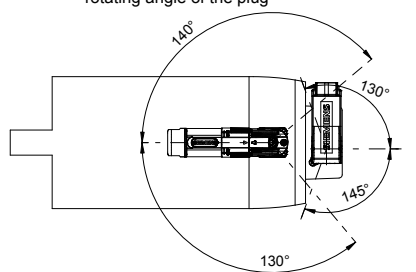

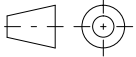
		SIEMENS	
Einheit / unit: mm	Synchron-Servomotor Synchronous Servo Motor:	1FT7062-5AF70-1FA1	
nicht tolerierte Maße / not toleranced dimensions:	Optionen / options:	Gewicht / mass:	7.1 kg
Maßstab / scale: ohne / without	Bemerkung / notice:		
CAD CREATOR 2.2 (WWW-Version V02.20.00.00)	Druckdatum / print date:	02.12.2019	