



Non-reversing motor starter with non-fusible disconnect

Controller half size 3 1/2

3-Phase, 3-Pole

Maximum voltage rating 600VAC

Max Hp 60Hz: 30@200V; 40@230V; 75@460V; 75@575V

Solid-state overload relay(s) with 50–200A range

Control voltage 190–220/220–240V 50/60Hz

NEMA Type 4,12 enclosure

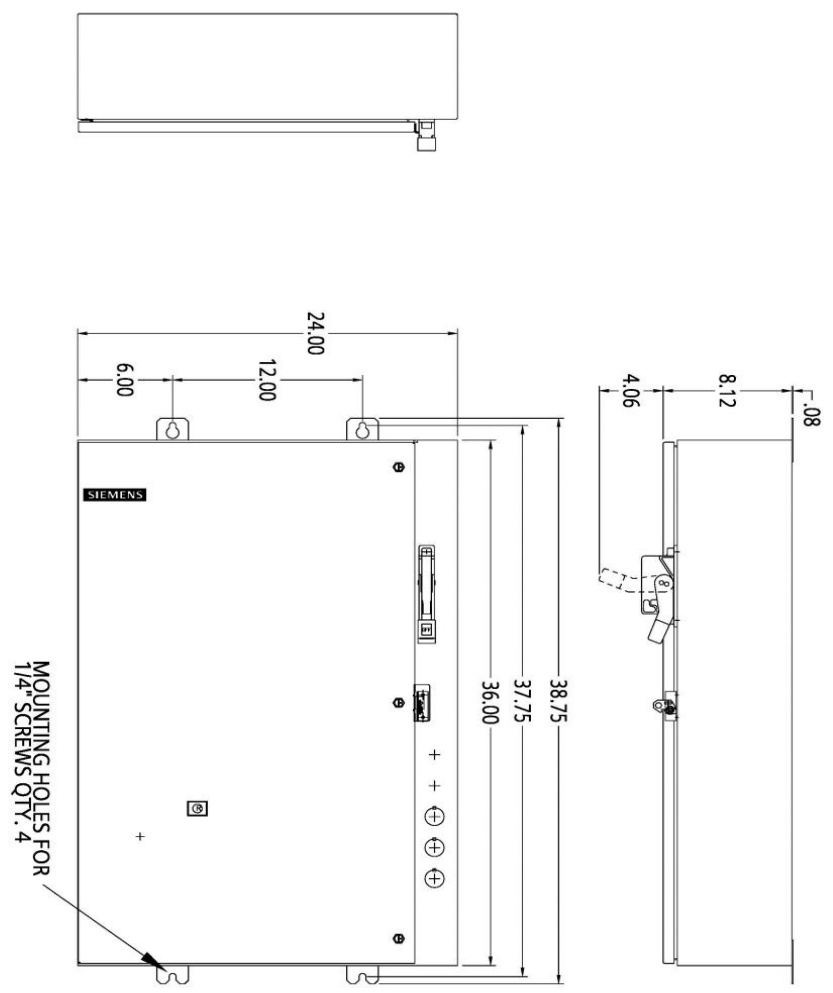

Image is representative and may not depict the actual product.

General technical data:	
Weight	85 lb
Height x Width x Depth	36 x 24 x 8 in.
Finger-safe (main circuit / control circuit)	NA / NA
Maximum altitude	6560 ft
Ambient storage temperature	(-30 to 65)°C / (-22 to 149)°F
Ambient operating temperature	(-20 to 40)°C / (-4 to 104)°F
Humidity (% non-condensing)	(no data)
Rated impulse voltage resistance	(no data)
Rated insulation voltage	(no data)
Country of origin	USA
Contactors:	
Number of NO main contacts	3
Amp rating	115A
Mechanical operating cycles	5,000,000
Internal/standard auxiliary contact:	
Number of NC / NO auxiliary contacts	0NC / 1NO
Rating	10A@600VAC (A600), 5A@600VDC (P600)
Optional auxiliary contact:	
Max number of NC / NO auxiliary contacts	7 total
Rating	10A@600VAC (A600), 5A@600VDC (P600)
Coil:	
Voltage	190–220/220–240V 50/60Hz Coil
Sealed watts	14W
Inrush / sealed power	310 / 26 VA
Normal coil operating limits (% of rated voltage)	85% - 110%
Typical drop-out volts (% of rated voltage)	50%
Pick-up time / Drop-out time	26-41 / 14-19 msec
Overload Relay:	
Current range	50–200A
Trip Class	Class 5 / 10 / 20 (factory set) / 30
Trip detection	Overload, phase failure, phase unbalance, ground fault
Phase failure sensitivity	Trip time after phase-loss: < 3 sec
Repeat accuracy	Within 1%
Reset options	Manual, automatic and remote
External reset	Yes
Test function	Electronics & manual actuation
Conformal coating on printed circuit board	Yes
Number of NC / NO auxiliary contacts	1NC / 1NO
Rating of auxiliary contacts	5A@600VAC (B600), 1A@250VDC (R300)

Single contact isolation	600V
Dual contact isolation	300V differing polarity / 600V common polarity
Disconnect Switch:	
Rating	200A/600V non-fusible
Fuse type accepted	NA
Enclosure:	
Type	NEMA Type 4,12 enclosure
Rating	Dust-tight, watertight & weather proof
Mounting/wiring:	
Mounting orientation	Vertical
Mounting type	Surface
Line side connection type / torque	Box lug / 275 lb in
Line side solid & stranded conductors	1x(6 AWG - 300 Kcmil) 75°C AL or CU
Load side connection type / torque	Box lug / 120 lb-in.
Load side solid & stranded conductors	1x(14 - 2/0 AWG) 75°C AL or CU
Coil connection type / torque	Screw / 5 lb in. - 12 lb in.
Coil solid & stranded conductors	2 x (16 - 12 AWG) CU 60/75°C
Main auxiliary contact connection type / torque	Screw / 10 - 15 lb-in
Main auxiliary contact solid & stranded conductors	1 x (12 AWG), 2 x (16 - 14 AWG), 2 x (18 - 16 AWG) 75°C CU
OLR auxiliary contact connection type / torque	Screw / 7 lb in. - 10 lb in.
OLR auxiliary contact solid & stranded conductors	2 x (20 - 14 AWG) CU 60/75°C
Short circuit current rating:	
Fuses	10kA@600V (Class H or K); 100kA@600V (Class R or J)
Certificates/approvals:	
	UL (file no. E185287) cUL (file no. E185287 for Canada) CSA (file no. 006535 C 000) ISO 9001 certification
Additional information:	
	Brochure OLR instruction sheet & trip curves

OUTLINE 36x24x8 NEMA 12/3/3R/4



MOUNTING HOLES FOR
1/4" SCREWS QTY. 4

DIMENSIONS ARE IN INCHES.
FILE NAME: SFIS-D68774006-0211



REF. D68782001