

1

2

3

4

5

6

7

8

back view

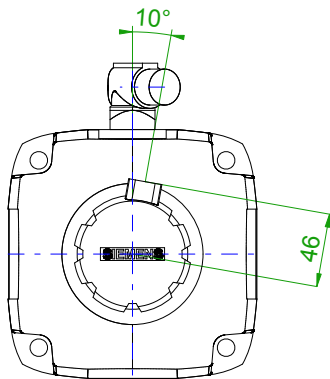

front view

center hole
DIN 332-DR M12

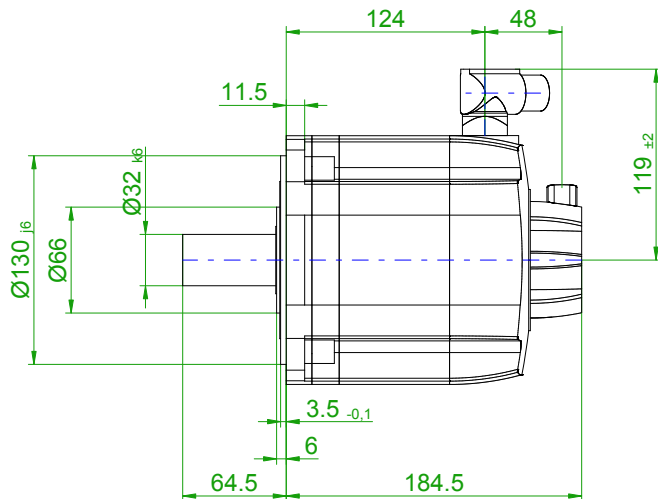
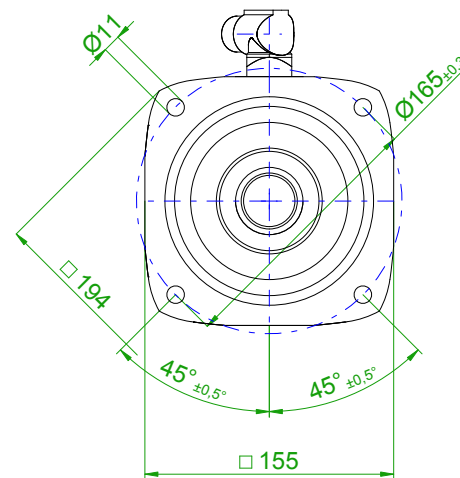

6-pole plug size 1
for power

10-pole
signal plug

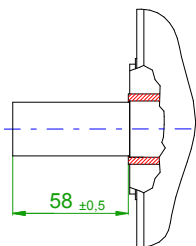
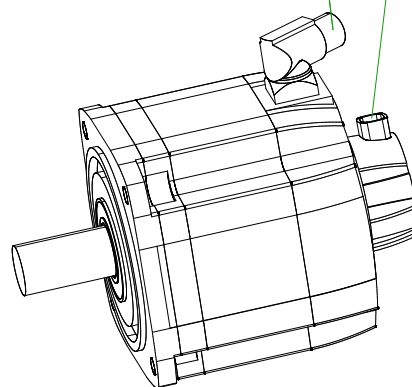

rotating angle of the plug

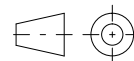
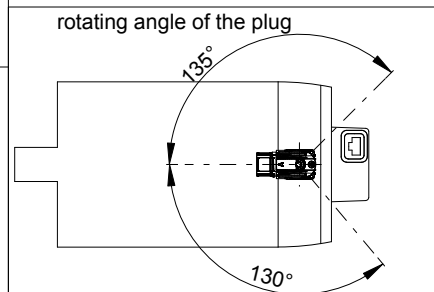

SIEMENS

Einheit / unit: mm

Synchron-Servomotor
Synchronous Servo Motor:

1FT7082-5AF70-1CG1

nicht tolerierte Maße /
not toleranced dimensions: ±1

Optionen / options:

Gewicht / mass:

14.0 kg

Maßstab / scale: ohne / without

Bemerkung / notice:

CAD CREATOR 2.2 (WWW-Version V02.20.00.00)

Druckdatum / print date:

28.04.2019