

back view

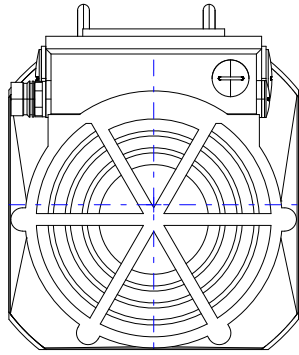

front view

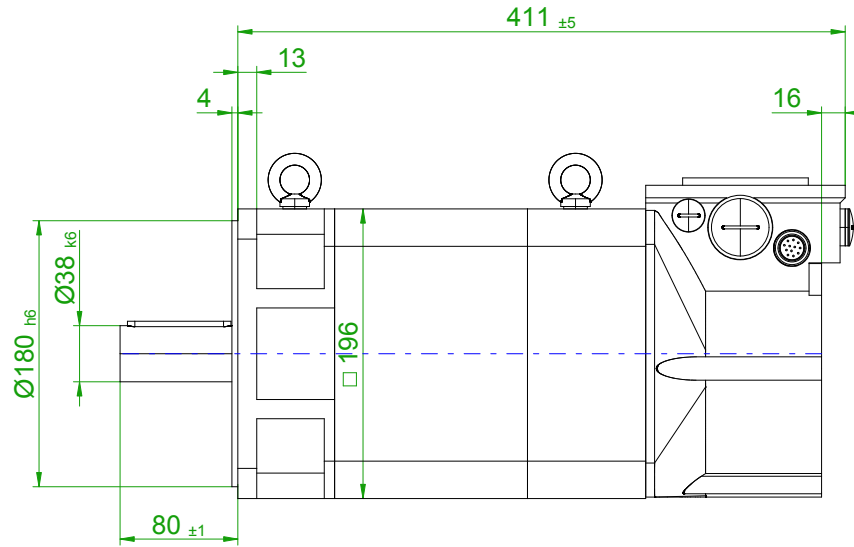
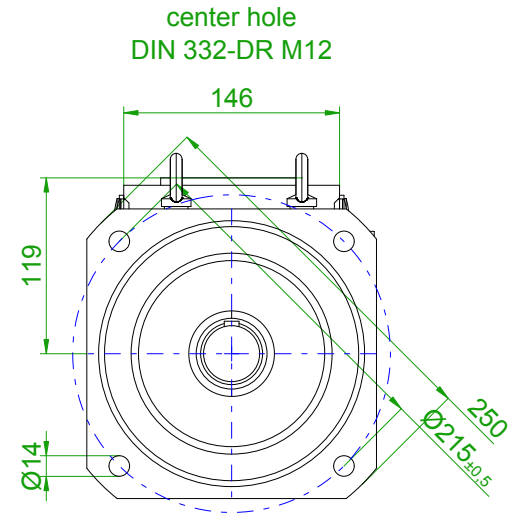

version with featherkey

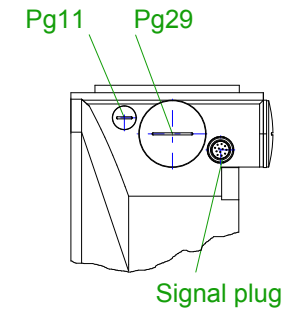
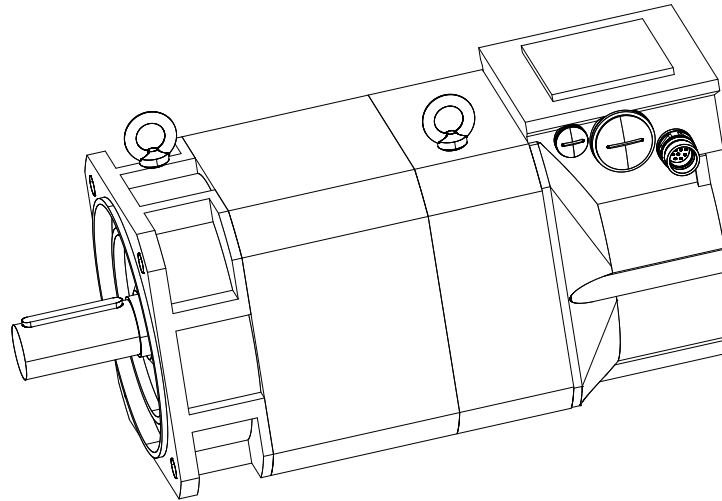
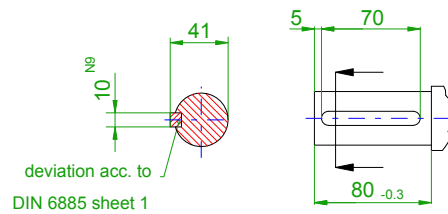

flange and shaft acc. to DIN 42955-R
flange size FF215 acc. to DIN EN 50347

type of construction IM B5

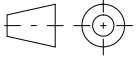
		SIEMENS	
Einheit / unit: mm	Asynchron-Servomotor Asynchronous Servo Motor:	1PH7103-2JG02-0BB3	
nicht tolerierte Maße / not toleranced dimensions:	Optionen / options:	Gewicht / mass:	42.5 kg
Maßstab / scale: ohne / without	Bemerkung / notice:		
CAD CREATOR 2.2 (WWW-Version V02.20.00.00)	Druckdatum / print date:	28.01.2020	