

Capacitor contactor, AC-6b 16.7 kVAr, / 400 V 1 NO + 2 NC, 24 V AC, 50 Hz 3-pole, Size S00 screw terminal



<b>Product brand name</b>	SIRIUS
<b>Product designation</b>	capacitor contactors
<b>Product type designation</b>	3RT26
<b>General technical data</b>	
<b>Size of contactor</b>	S0
<b>Product extension</b>	
• Auxiliary switch	No
<b>Surge voltage resistance</b>	
• of main circuit rated value	6 kV
• of auxiliary circuit rated value	6 kV
<b>maximum permissible voltage for safe isolation</b>	
• between coil and main contacts acc. to EN 60947-1	400 V
<b>Protection class IP</b>	
• on the front	IP20
• of the terminal	IP20
<b>Shock resistance at rectangular impulse</b>	
• at AC	7,5g / 5 ms, 4,7g / 10 ms
<b>Shock resistance with sine pulse</b>	

<ul style="list-style-type: none"> <li>• at AC</li> </ul>	11,8g / 5 ms, 7,4g / 10 ms
<b>Mechanical service life (switching cycles)</b>	
<ul style="list-style-type: none"> <li>• of the contactor with added auxiliary switch block typical</li> </ul>	3 000 000
<b>Electrical endurance (switching cycles)</b>	200 000
<b>Reference code acc. to DIN EN 81346-2</b>	Q

Ambient conditions	
<b>Installation altitude at height above sea level</b>	
<ul style="list-style-type: none"> <li>• maximum</li> </ul>	2 000 m
<b>Ambient temperature</b>	
<ul style="list-style-type: none"> <li>• during operation</li> </ul>	-25 ... +60 °C
<ul style="list-style-type: none"> <li>• during storage</li> </ul>	-55 ... +80 °C

Main circuit	
<b>Number of NO contacts for main contacts</b>	3
<b>Number of NC contacts for main contacts</b>	0
<b>Operating current</b>	
<ul style="list-style-type: none"> <li>• at AC-6b at 690 V at ambient temperature 60 °C rated value</li> </ul>	24 A
<b>Operational reactive power at AC-6b</b>	
<ul style="list-style-type: none"> <li>• at 230 V at 50/60 Hz at ambient temperature 60 °C rated value</li> </ul>	3 ... 9.6 kvar
<ul style="list-style-type: none"> <li>• at 400 V at 50/60 Hz at ambient temperature 60 °C rated value</li> </ul>	6 ... 16.7 kvar
<ul style="list-style-type: none"> <li>• at 500 V at 50/60 Hz at ambient temperature 60 °C rated value</li> </ul>	7 ... 21 kvar
<ul style="list-style-type: none"> <li>• at 690 V at 50/60 Hz at ambient temperature 60 °C rated value</li> </ul>	10 ... 29 kvar
<b>No-load switching frequency</b>	
<ul style="list-style-type: none"> <li>• at AC</li> </ul>	500 1/h
<b>Operating frequency at AC-6b</b>	
<ul style="list-style-type: none"> <li>• at 230 V maximum</li> </ul>	180 1/h
<ul style="list-style-type: none"> <li>• at 240 V maximum</li> </ul>	180 1/h
<ul style="list-style-type: none"> <li>• at 400 V maximum</li> </ul>	180 1/h
<ul style="list-style-type: none"> <li>• at 480 V maximum</li> </ul>	180 1/h
<ul style="list-style-type: none"> <li>• at 500 V maximum</li> </ul>	180 1/h
<ul style="list-style-type: none"> <li>• at 600 V maximum</li> </ul>	180 1/h
<ul style="list-style-type: none"> <li>• at 690 V maximum</li> </ul>	150 1/h

Control circuit/ Control	
<b>Type of voltage</b>	AC
<b>Type of voltage of the control supply voltage</b>	AC
<b>Control supply voltage at AC</b>	
<ul style="list-style-type: none"> <li>• at 50 Hz rated value</li> </ul>	24 V

<b>Control supply voltage frequency</b>	
<ul style="list-style-type: none"> <li>• 1 rated value</li> </ul>	50 Hz
<b>Operating range factor control supply voltage rated value of magnet coil at AC</b>	
<ul style="list-style-type: none"> <li>• at 50 Hz</li> </ul>	0.8 ... 1.1
<b>Apparent pick-up power of magnet coil at AC</b>	77 V·A
<b>Inductive power factor with closing power of the coil</b>	0.82
<b>Apparent holding power of magnet coil at AC</b>	9.8 V·A
<b>Inductive power factor with the holding power of the coil</b>	0.25
<b>Closing delay</b>	
<ul style="list-style-type: none"> <li>• at AC</li> </ul>	9 ... 38 ms
<b>Arcing time</b>	10 ... 15 ms
<b>Residual current of the electronics for control with signal &lt;0&gt;</b>	
<ul style="list-style-type: none"> <li>• at AC at 230 V maximum permissible</li> </ul>	6 mA

#### Auxiliary circuit

<b>Number of NC contacts for auxiliary contacts</b>	2
<ul style="list-style-type: none"> <li>• attachable</li> </ul>	0
<ul style="list-style-type: none"> <li>• instantaneous contact</li> </ul>	2
<b>Number of NO contacts for auxiliary contacts</b>	1
<ul style="list-style-type: none"> <li>• attachable</li> </ul>	0
<ul style="list-style-type: none"> <li>• instantaneous contact</li> </ul>	1
<b>Operating current of auxiliary contacts at AC-12 maximum</b>	10 A
<b>Operating current of auxiliary contacts at AC-15</b>	
<ul style="list-style-type: none"> <li>• at 230 V</li> </ul>	6 A
<ul style="list-style-type: none"> <li>• at 400 V</li> </ul>	3 A
<b>Operating current of auxiliary contacts at DC-13</b>	
<ul style="list-style-type: none"> <li>• at 24 V</li> </ul>	6 A
<ul style="list-style-type: none"> <li>• at 60 V</li> </ul>	2 A
<ul style="list-style-type: none"> <li>• at 110 V</li> </ul>	1 A
<ul style="list-style-type: none"> <li>• at 125 V</li> </ul>	0.9 A
<ul style="list-style-type: none"> <li>• at 220 V</li> </ul>	0.3 A
<b>Contact reliability of auxiliary contacts</b>	0.00000001

#### UL/CSA ratings

<b>Contact rating of auxiliary contacts according to UL</b>	A600 / Q600
---	-------------

#### Short-circuit protection

<b>Design of the fuse link</b>	
<ul style="list-style-type: none"> <li>• for short-circuit protection of the main circuit <ul style="list-style-type: none"> <li>— with type of coordination 1 required</li> </ul> </li> </ul>	gG: 50 A (690 V, 50 kA)

- for short-circuit protection of the auxiliary switch required

gG: 10 A (500 V, 1 kA)

### Installation/ mounting/ dimensions

<b>Mounting position</b>	+/-180° rotation possible on vertical mounting surface; can be tilted forward and backward by +/- 22.5° on vertical mounting surface
<b>Mounting type</b>	screw and snap-on mounting onto 35 mm standard mounting rail according to DIN EN 50022
<b>Height</b>	135 mm
<b>Width</b>	45 mm
<b>Depth</b>	155 mm
<b>Required spacing</b>	
<ul style="list-style-type: none"> <li>• with side-by-side mounting           <ul style="list-style-type: none"> <li>— at the side</li> </ul> </li> </ul>	10 mm
<ul style="list-style-type: none"> <li>• for grounded parts           <ul style="list-style-type: none"> <li>— at the side</li> </ul> </li> </ul>	10 mm

### Connections/ Terminals

<b>Type of electrical connection</b>	
<ul style="list-style-type: none"> <li>• for main current circuit</li> </ul>	screw-type terminals
<ul style="list-style-type: none"> <li>• for auxiliary and control current circuit</li> </ul>	screw-type terminals
<b>Type of connectable conductor cross-sections</b>	
<ul style="list-style-type: none"> <li>• for main contacts           <ul style="list-style-type: none"> <li>— solid</li> <li>— stranded</li> <li>— single or multi-stranded</li> <li>— finely stranded with core end processing</li> </ul> </li> <li>• at AWG conductors for main contacts</li> </ul>	2x (1 ... 2.5 mm <sup>2</sup> ), 2x (2.5 ... 10 mm <sup>2</sup> ) 2x (1 ... 2.5 mm <sup>2</sup> ), 2x (2.5 ... 10 mm <sup>2</sup> ) 2x (1 ... 2,5 mm <sup>2</sup> ), 2x (2,5 ... 10 mm <sup>2</sup> ) 2x (1 ... 2.5 mm <sup>2</sup> ), 2x (2.5 ... 6 mm <sup>2</sup> ), 1x 10 mm <sup>2</sup> 2x (16 ... 12), 2x (14 ... 8)
<b>Type of connectable conductor cross-sections</b>	
<ul style="list-style-type: none"> <li>• for auxiliary contacts           <ul style="list-style-type: none"> <li>— solid</li> <li>— single or multi-stranded</li> <li>— finely stranded with core end processing</li> </ul> </li> <li>• at AWG conductors for auxiliary contacts</li> </ul>	2x (0.5 ... 1.5 mm <sup>2</sup> ), 2x (0.75 ... 2.5 mm <sup>2</sup> ), 2x 4 mm <sup>2</sup> 2x (0,5 ... 1,5 mm <sup>2</sup> ), 2x (0,75 ... 2,5 mm <sup>2</sup> ), 2x 4 mm <sup>2</sup> 2x (0.5 ... 1.5 mm <sup>2</sup> ), 2x (0.75 ... 2.5 mm <sup>2</sup> ) 2x (20 ... 16), 2x (18 ... 14), 2x 12
<b>Type of minimum connectable cross-section for main contacts at AC-6b</b>	
<ul style="list-style-type: none"> <li>• at 40 °C</li> <li>• at 60 °C</li> </ul>	1x 6 mm <sup>2</sup> 1x 10 mm <sup>2</sup> , 2x 6 mm <sup>2</sup>
AWG number as coded connectable conductor cross section for main contacts	16 ... 8

### Safety related data

<b>Product function</b>	
<ul style="list-style-type: none"> <li>• Mirror contact acc. to IEC 60947-4-1</li> </ul>	No









- positively driven operation acc. to IEC 60947-5-1

No

Protection against electrical shock

finger-safe

### Certificates/ approvals

General Product Approval			EMC	Declaration of Conformity	
 CCC	 CSA	 UL	 EAC	 RCM	 EG-Konf.
Declaration of Conformity	Test Certificates	Marine / Shipping		other	
<a href="#">Miscellaneous</a>	<a href="#">Type Test Certificates/Test Report</a>	 BUREAU VERITAS	 RMRS	<a href="#">Confirmation</a>  VDE	

### Further information

**Information- and Downloadcenter (Catalogs, Brochures,...)**

[www.siemens.com/sirius/catalogs](http://www.siemens.com/sirius/catalogs)

**Industry Mall (Online ordering system)**

<https://mall.industry.siemens.com/mall/en/en/Catalog/product?mlfb=3RT2625-1AB05>

**Cax online generator**

<http://support.automation.siemens.com/WW/CAXorder/default.aspx?lang=en&mlfb=3RT2625-1AB05>

**Service&Support (Manuals, Certificates, Characteristics, FAQs,...)**

<https://support.industry.siemens.com/cs/ww/en/ps/3RT2625-1AB05>

**Image database (product images, 2D dimension drawings, 3D models, device circuit diagrams, EPLAN macros, ...)**

[http://www.automation.siemens.com/bilddb/cax\\_de.aspx?mlfb=3RT2625-1AB05&lang=en](http://www.automation.siemens.com/bilddb/cax_de.aspx?mlfb=3RT2625-1AB05&lang=en)

**Characteristic: Tripping characteristics, I<sup>2</sup>t, Let-through current**

<https://support.industry.siemens.com/cs/ww/en/ps/3RT2625-1AB05/char>

**Further characteristics (e.g. electrical endurance, switching frequency)**

<http://www.automation.siemens.com/bilddb/index.aspx?view=Search&mlfb=3RT2625-1AB05&objecttype=14&gridview=view1>

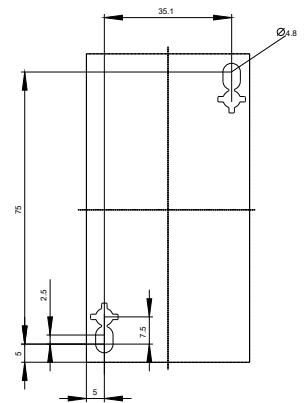
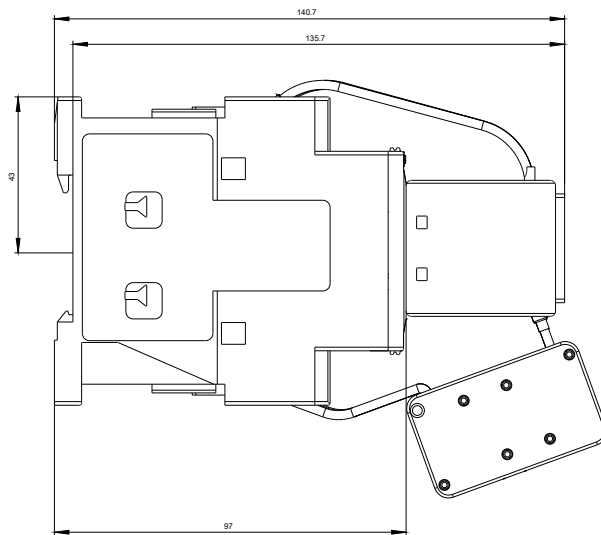
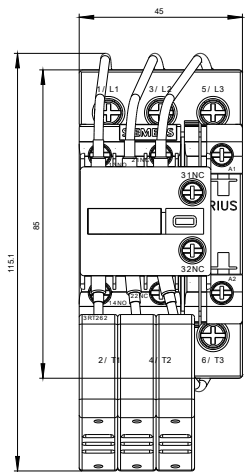

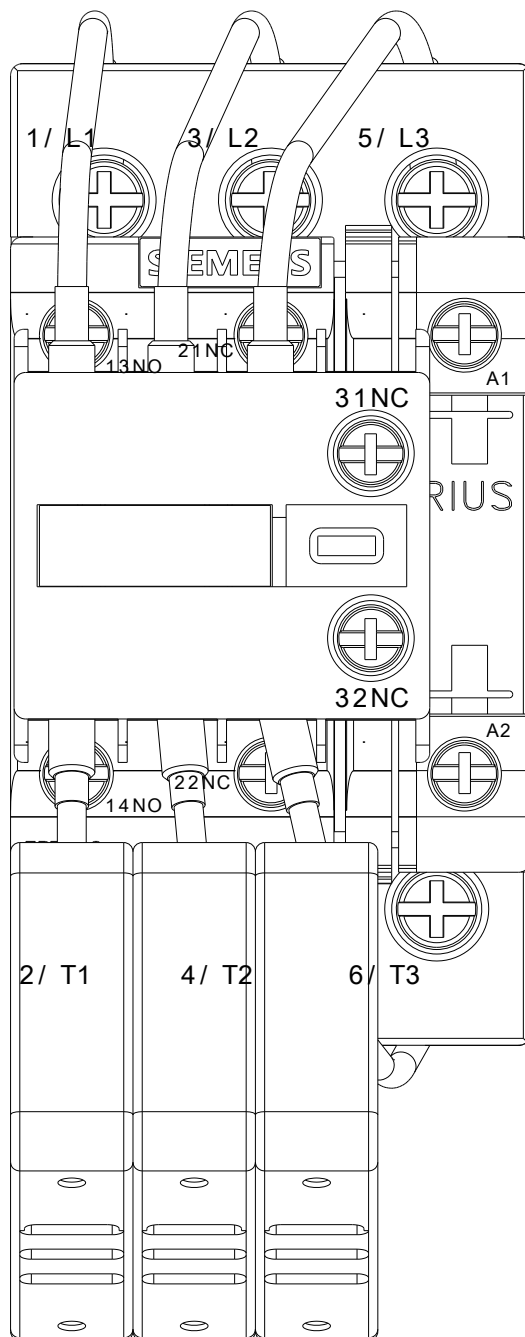

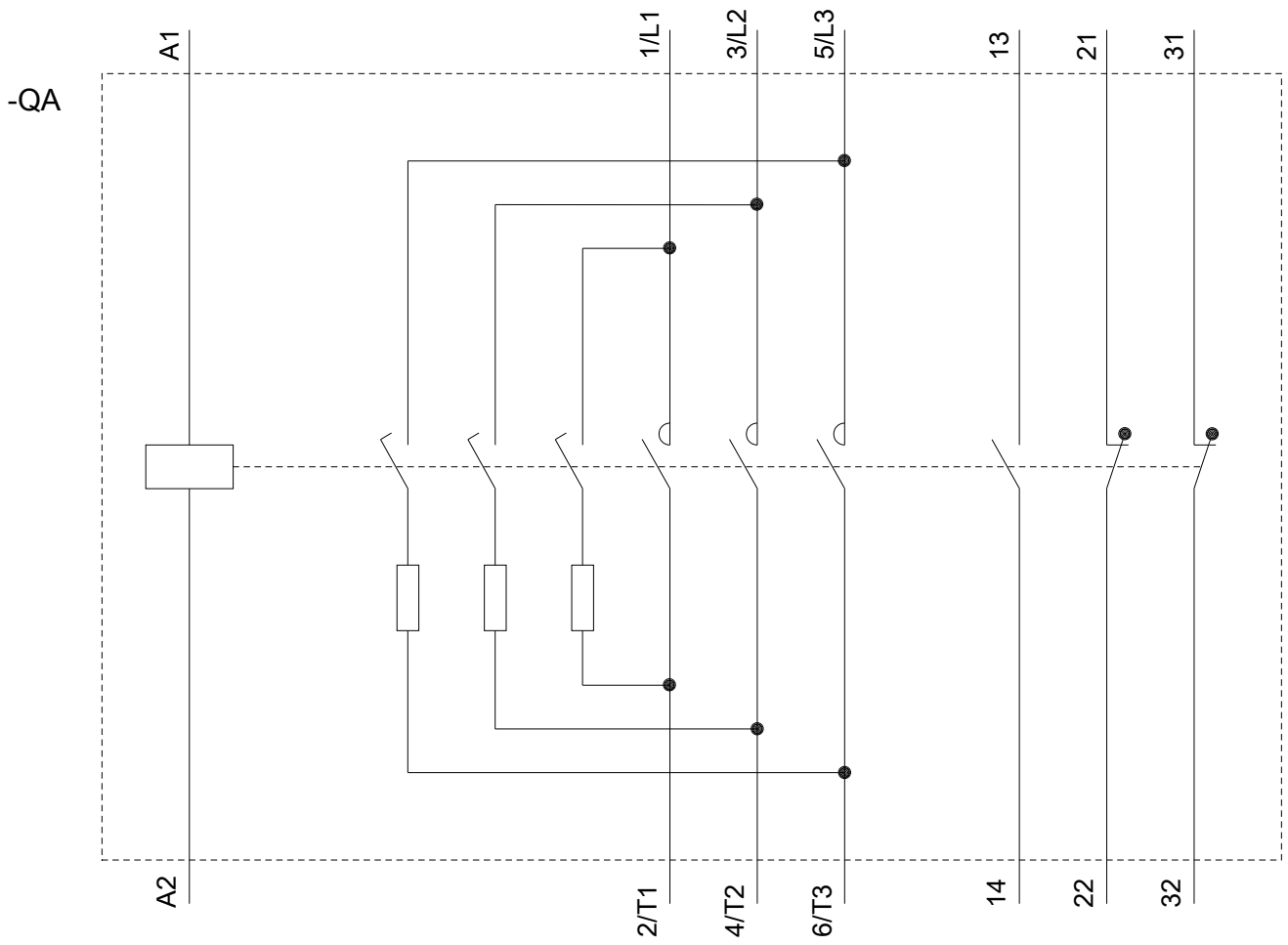

last modified:

08/01/2019