

3-phase supply terminal for 3-phase busbar for self-protection combination motor controller (type E) for circuit breaker 3RV Size S00/S0 Multi-unit packaging Pack = 50 units

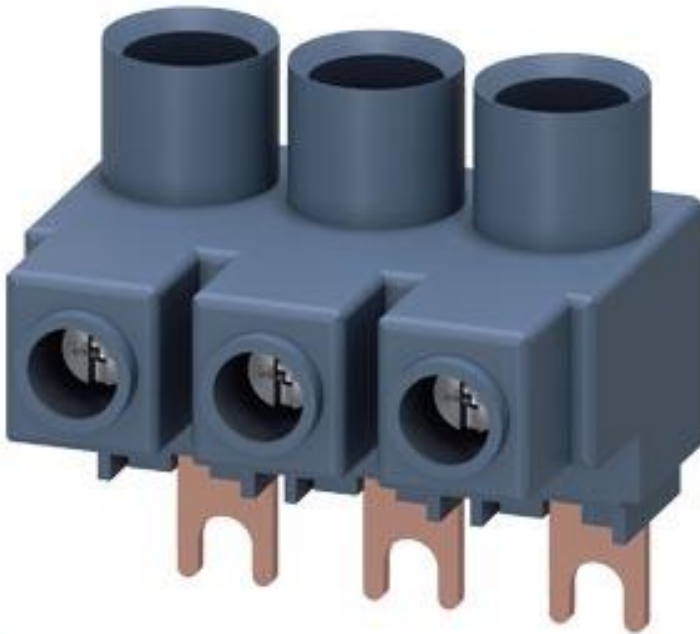







Figure similar

General technical data

Product brand name	SIRIUS
Product designation	Three-phase feeder terminal

Certificates/ approvals

General Product Approval		Shipping Approval			
 UL		 ABS	 BUREAU VERITAS	 LRS	 RMRS

other

[Confirmation](#)



Further information

Information- and Downloadcenter (Catalogs, Brochures,...)

<https://www.siemens.com/ic10>

Industry Mall (Online ordering system)

<https://mall.industry.siemens.com/mall/en/en/Catalog/product?mfb=3RV2925-5EB-Z X90>

Cax online generator

<http://support.automation.siemens.com/WW/CAXorder/default.aspx?lang=en&mfb=3RV2925-5EB-Z X90>

Service&Support (Manuals, Certificates, Characteristics, FAQs,...)

<https://support.industry.siemens.com/cs/ww/en/ps/3RV2925-5EB-Z X90>

Image database (product images, 2D dimension drawings, 3D models, device circuit diagrams, EPLAN macros, ...)

http://www.automation.siemens.com/bilddb/cax_de.aspx?mfb=3RV2925-5EB-Z X90&lang=en

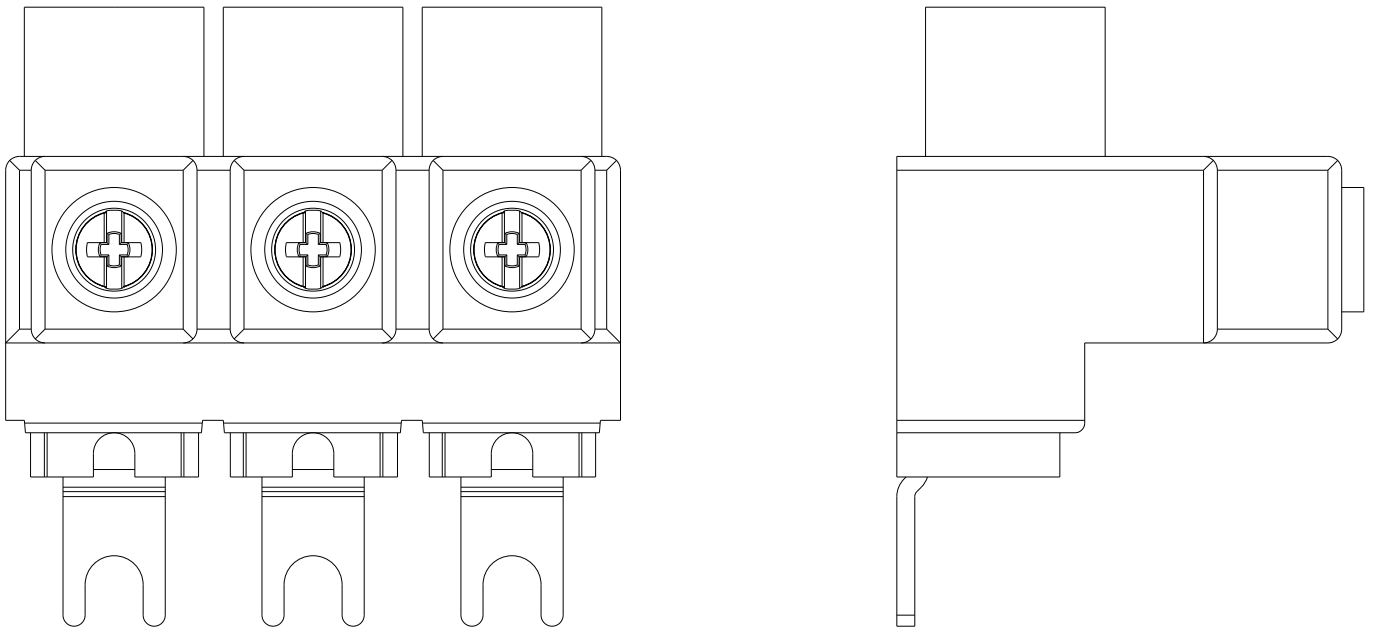

last modified:

01/08/2020