

back view

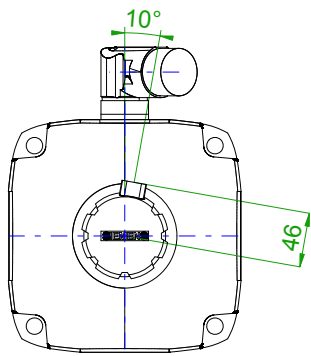

front view

center hole  
DIN 332-DR M12

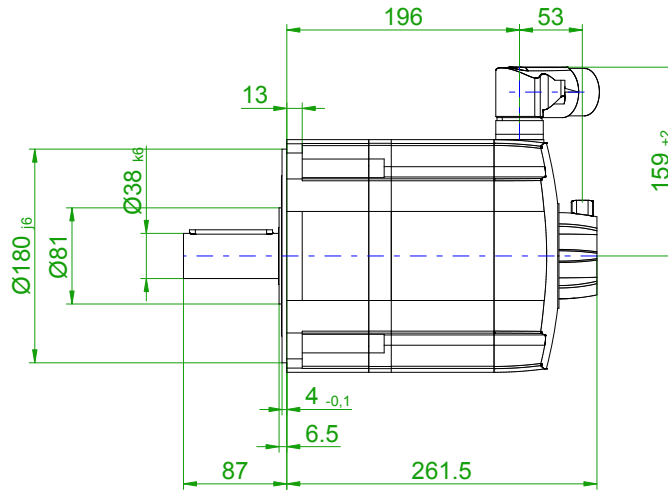
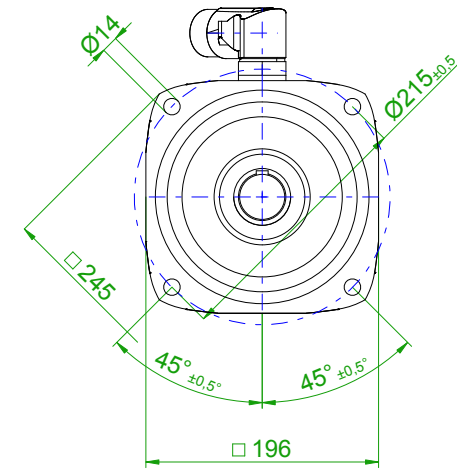

version with featherkey

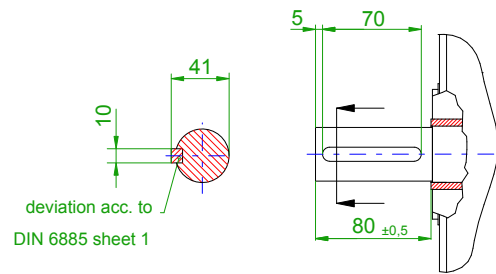

6-pole plug size 1.5  
for power and brake

10-pole  
signal plug

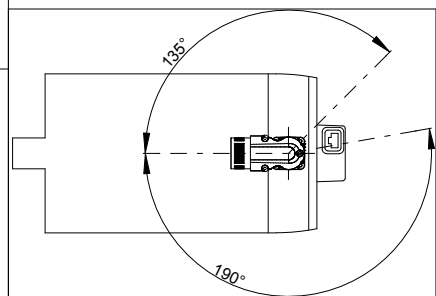
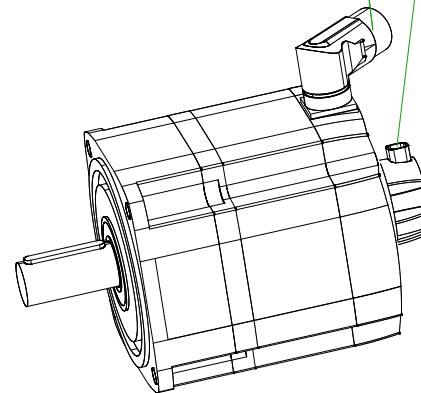

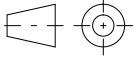
		<b>SIEMENS</b>	
Einheit / unit: mm		Synchron-Servomotor Synchronous Servo Motor:	1FT7102-5AC70-1CB0
nicht tolerierte Maße / not toleranced dimensions: ±1		Optionen / options:	
Maßstab / scale: ohne / without		Gewicht / mass:	32.3 kg
CAD CREATOR 2.2 (WWW-Version V02.20.00.00)		Bemerkung / notice:	
		Druckdatum / print date:	06.02.2020