

Confie a titre de secret d'entreprise. Tous droits réservés.
 Confiado como secreto industrial. Nos reservamos todos los derechos.
 Comunicado como segredo empresarial. Reservados todos os direitos.

Weitergabe sowie Vervielfältigung dieser Unterlage, Verwertung und Mitteilung ihres Inhalts nicht gestattet, soweit nicht ausdrücklich zugestanden. Zuwiderhandlungen verpflichten zu Schadenersatz. Alle Rechte vorbehalten, insbesondere fuer den Fall der Patenterteilung oder Gk-Eintragung.

The reproduction or use of this document or its contents is not permitted without express written authority. Offenders will be liable for damages. All rights, including rights created by patent grant or registration of a utility model or design, are reserved.

Copyright© Siemens AG 2005
 Cad-drawing: do not make any manual changes

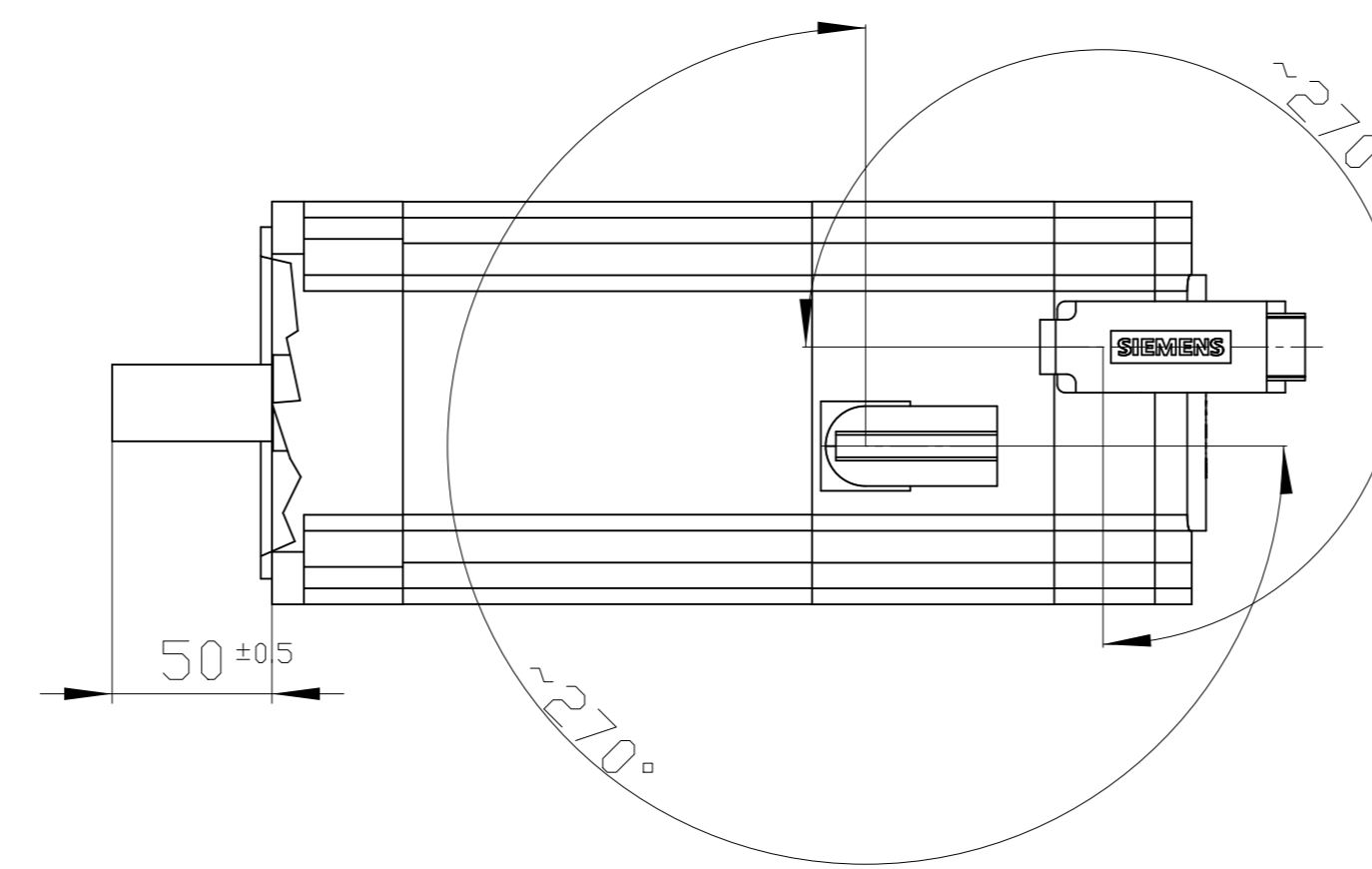
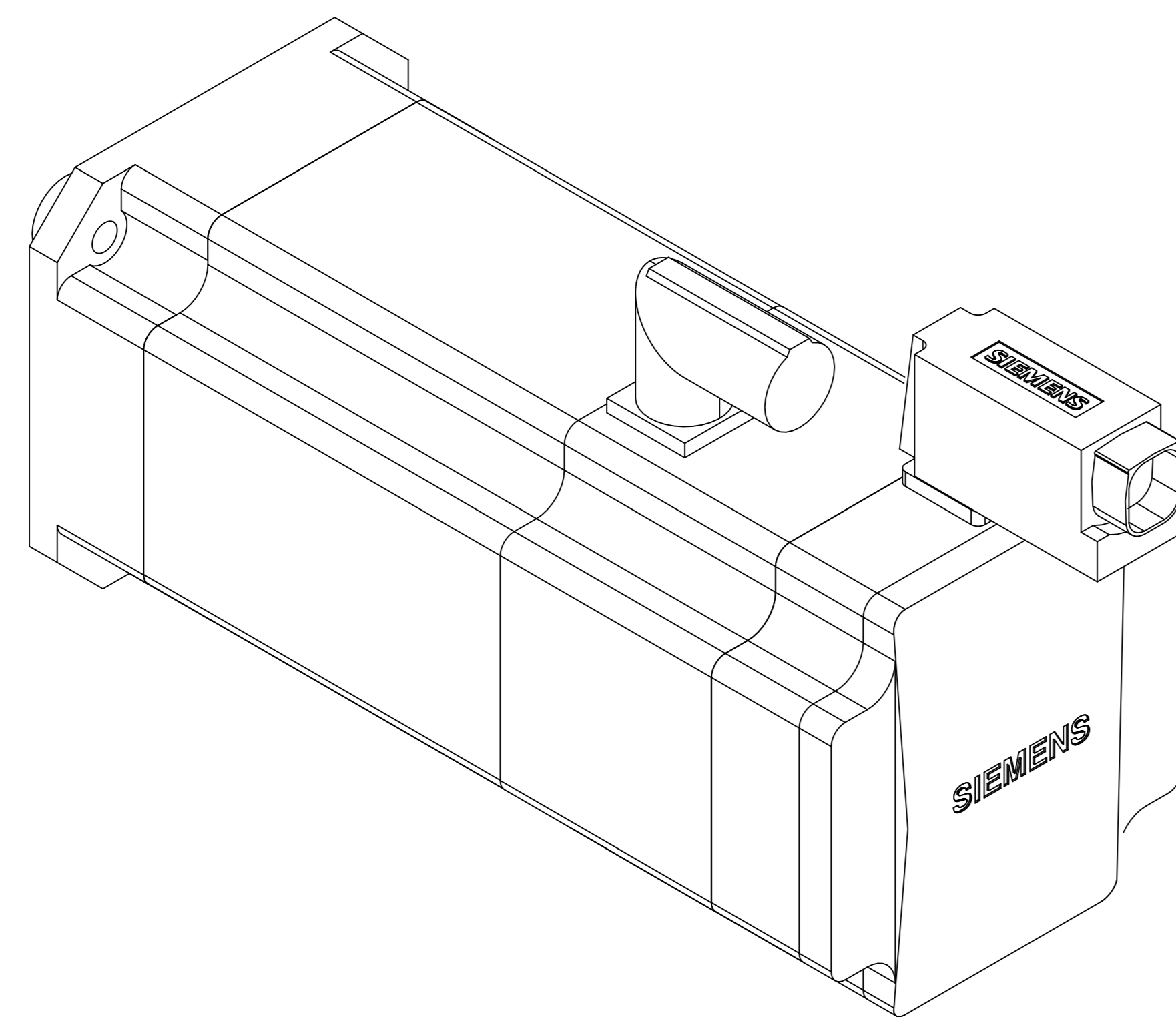
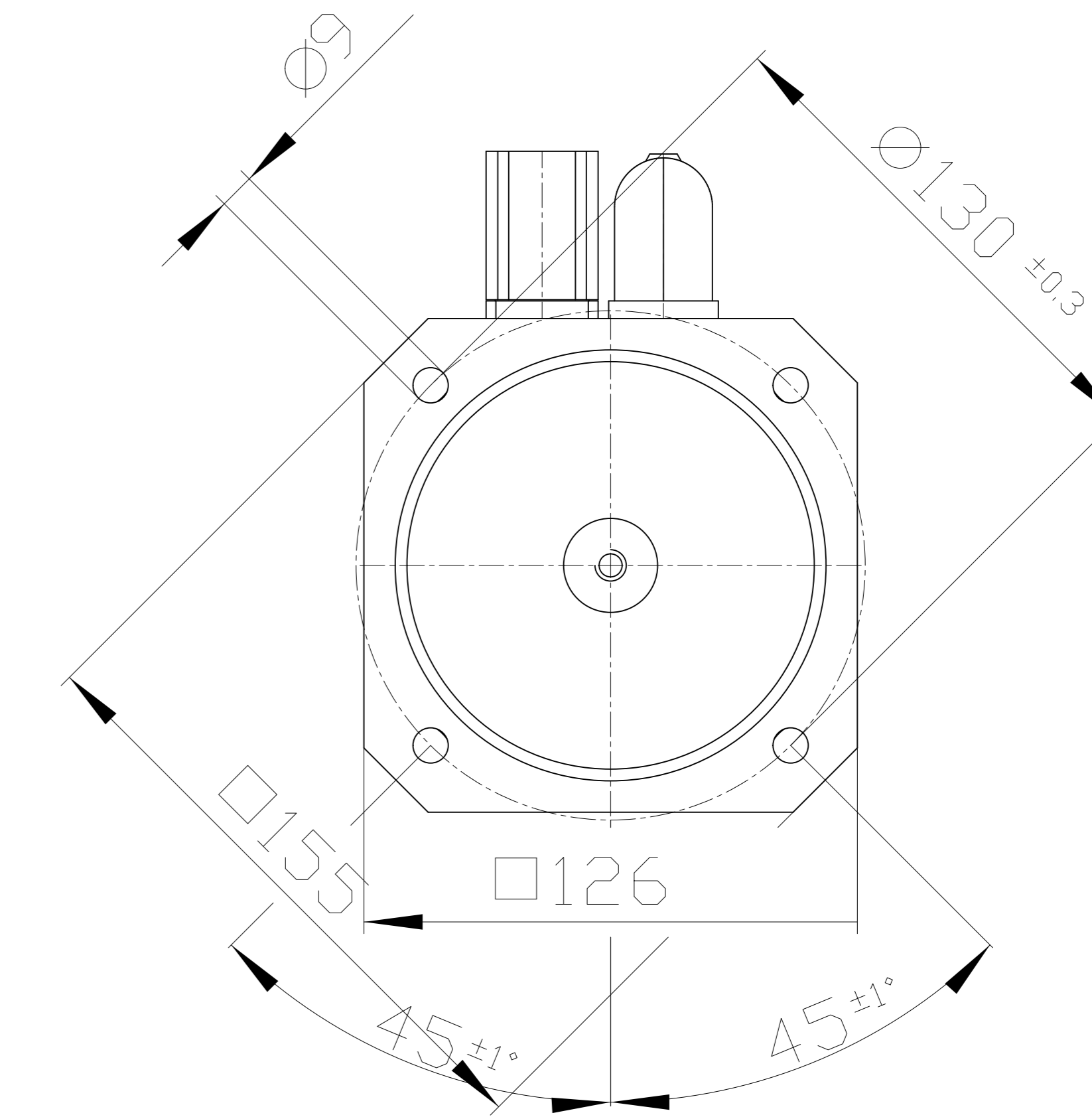
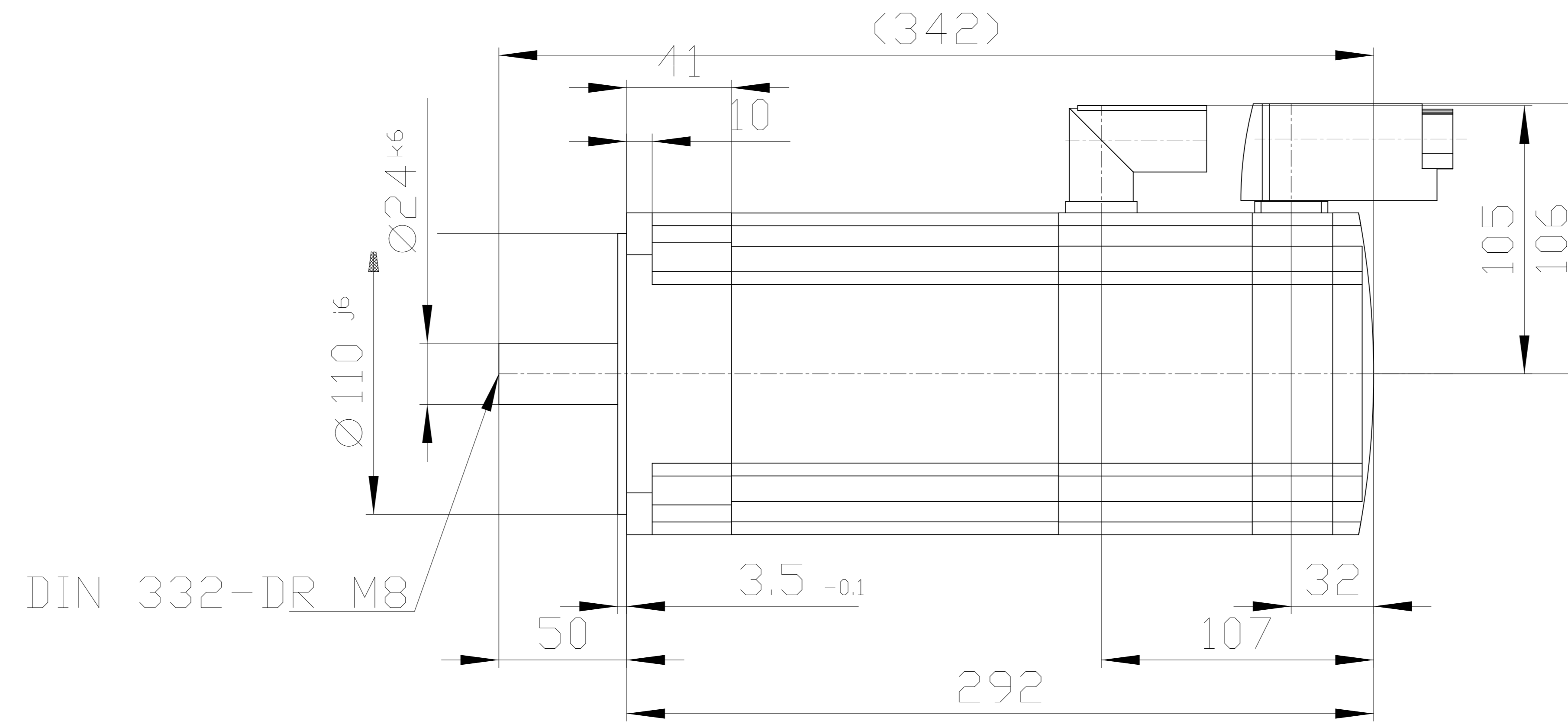
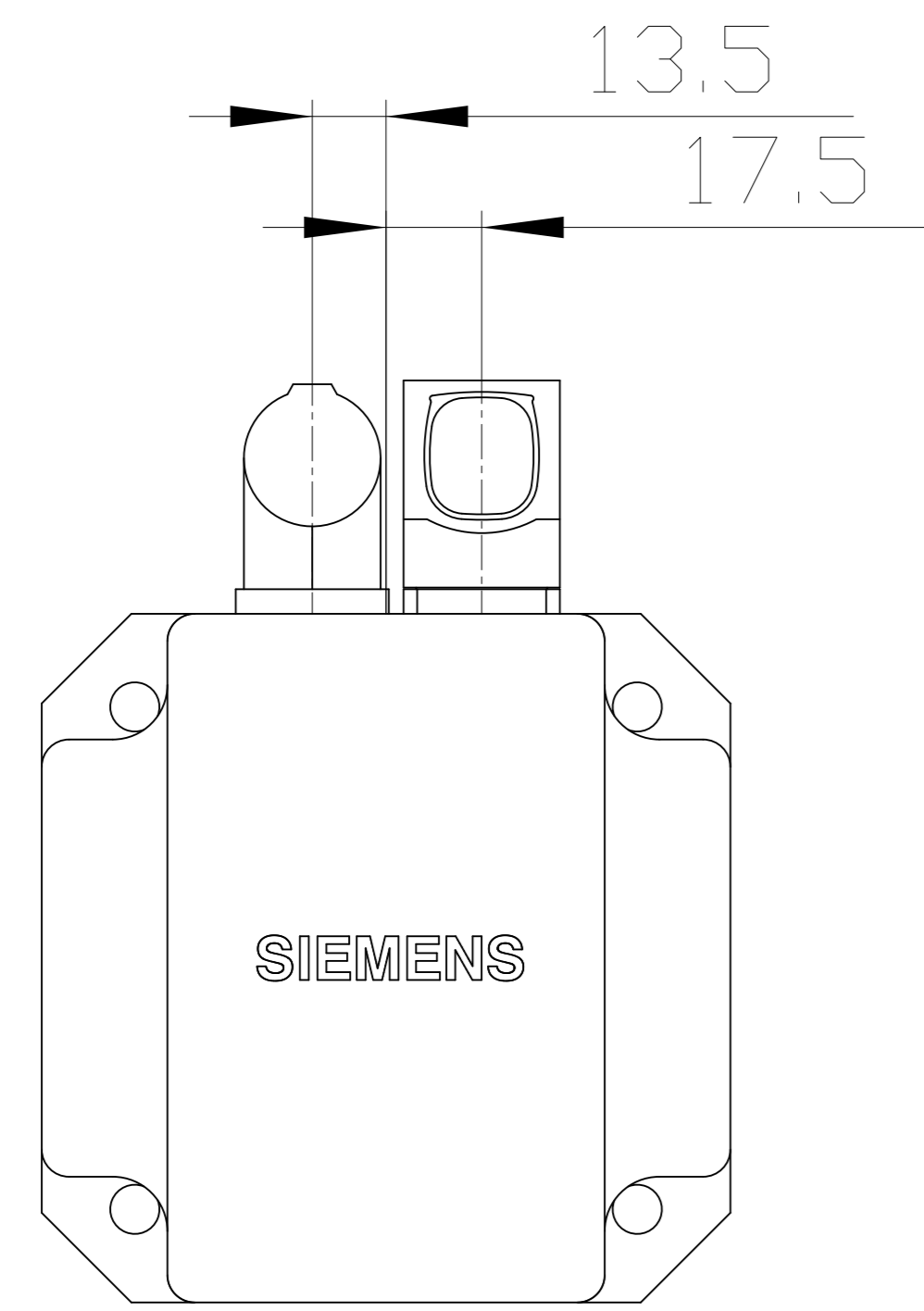

Connector size 1 = M23;
 6-pole for power and brake

Connector size M23, 17-pole

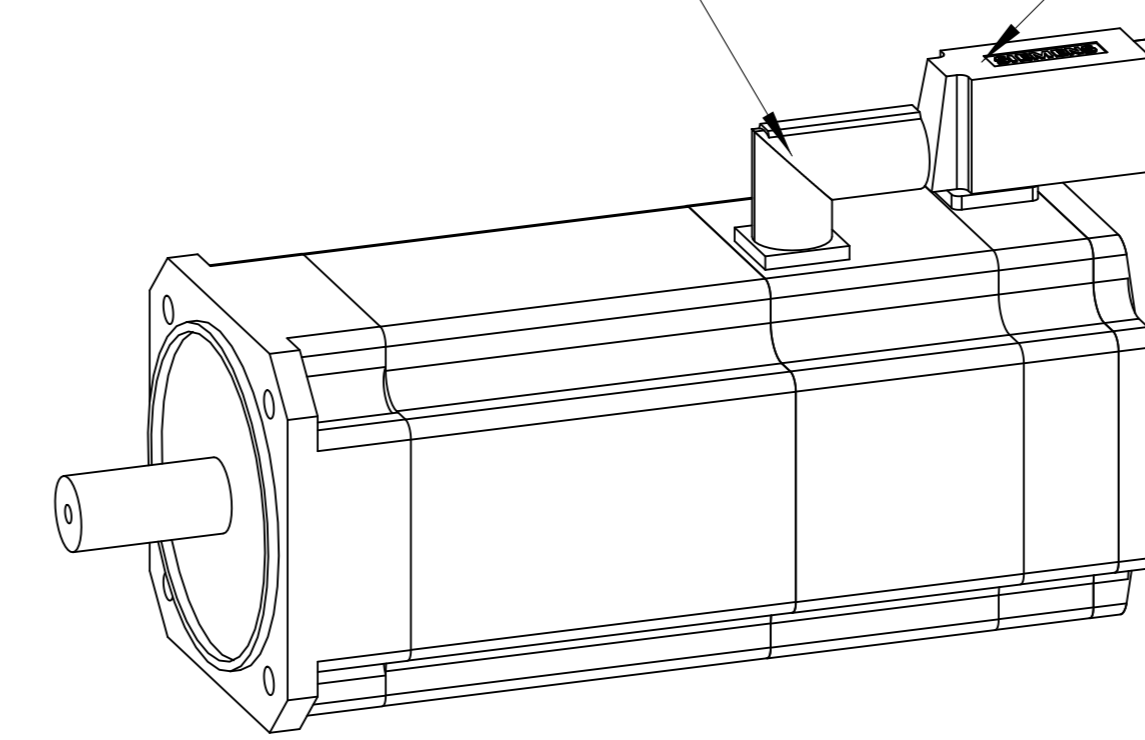

	?ANGEBOT?	
	?OPTIONEN?	
Unit	mm [in]	1FK7064-7AF71-1PH0
Date	Fri May 17 19:51:16 CEST 2019	
SIEMENS AG		
?GEWICHT?	?APPLICATION?	