

**SIEMENS**



Motion Control Drives

# SINAMICS Converters for Single-Axis Drives

SINAMICS G120X infrastructure converters  
for HVAC/Water/Wastewater

Catalog  
D 31.5

Edition  
February  
2019

[siemens.com/sinamics-g120x](https://www.siemens.com/sinamics-g120x)

## Related catalogs

<p><b>Motion Control Drives</b> D 31.1 SINAMICS Inverters for Single-Axis Drives Built-In Units</p> <p>E86060-K5531-A111-A1-7600</p>		<p><b>Industrial Controls</b> IC 10 SIRIUS</p> <p>PDF (E86060-K1010-A101-A9-7600)</p>	
<p><b>Motion Control Drives</b> D 31.2 SINAMICS Inverters for Single-Axis Drives Distributed Inverters</p> <p>E86060-K5531-A121-A1-7600</p>		<p><b>Industrial Controls</b> IC 10 AO SIRIUS Classic</p> <p>PDF (E86060-K1010-A191-A5-7600)</p>	
<p><b>SINAMICS S120</b> D 21.3 Chassis Format Converter Units Cabinet Modules</p> <p><b>SINAMICS S150</b> Converter Cabinet Units E86060-K5521-A131-A6-7600</p>		<p><b>Low-Voltage Power Distribution and Electrical Installation Technology</b> LV 10 SENTRON • SIVACON • ALPHA Protection, Switching, Measuring and Monitoring Devices, Switchboards and Distribution Systems PDF (E86060-K8280-A101-A7-7600) Print (E86060-K8280-A101-A6-7600)</p>	
<p><b>Motion Control Drives</b> D 21.4 SINAMICS S120 and SIMOTICS</p> <p>E86060-K5521-A141-A1-7600</p>		<p><b>SIMATIC</b> ST 70 Products for Totally Integrated Automation</p> <p>E86060-K4670-A101-B6-7600</p>	
<p><b>SIMOTICS S-1FG1</b> D 41 <b>Servo geared motors</b> Helical, Parallel shaft, Bevel and Helical worm geared motors</p> <p>E86060-K5541-A101-A3-7600</p>		<p><b>SIMATIC</b> ST 70 N Products for Totally Integrated Automation</p> <p>E86060-K4670-A151-A9-7600</p>	
<p><b>SIMOTICS GP, SD, XP, DP</b> D 81.1 <b>Low-Voltage Motors</b> Type series 1FP1, 1LE1, 1LE5, 1MB1 and 1PC1 Frame sizes 63 to 355 Power range 0.09 to 500 kW E86060-K5581-A111-B2-7600</p>		<p><b>SIMATIC HMI / PC-based Automation</b> ST 80/ST PC Human Machine Interface Systems PC-based Automation</p> <p>E86060-K4680-A101-C6-7600</p>	
<p><b>FLENDER Couplings</b> MD 10.1 Standard Couplings</p> <p>E86060-K5710-A111-A5-7600</p>		<p><b>Industrial Communication</b> IK PI SIMATIC NET</p> <p>E86060-K6710-A101-B8-7600</p>	
<p><b>SIMOGEAR</b> MD 50.1 <b>Geared Motors</b> Helical, parallel shaft, bevel, helical worm and worm geared motors</p> <p>E86060-K5250-A111-A5-7600</p>		<p><b>Products for Automation and Drives</b> CA 01 Interactive Catalog Download</p> <p><a href="http://www.siemens.com/ca01download">www.siemens.com/ca01download</a></p>	
<p><b>Motion Control System</b> PM 21 SIMOTION Equipment for Production Machines</p> <p>E86060-K4921-A101-A4-7600</p>		<p><b>Industry Mall</b> Information and Ordering Platform on the Internet:</p> <p><a href="http://www.siemens.com/industrymall">www.siemens.com/industrymall</a></p>	

**SIEMENS**

# SINAMICS Converters for Single-Axis Drives

SINAMICS G120X infrastructure converters  
for HVAC/Water/Wastewater  
Catalog D 31.5 · February 2019

Dear Customer,

We are happy to present you with the PDF version of the new Catalog D 31.5 · February 2019.

The catalog provides a comprehensive overview of the new SINAMICS G120X converter system for HVAC, water and wastewater applications in the infrastructure sector. With an available power range from 0.75 kW to 630 kW (1 hp to 700 hp), the new series masters every challenge here.

The products listed in this Catalog are also included in the Industry Mall.  
Please contact your local Siemens office for additional information.

Up-to-date information about SINAMICS G120X is available online at  
[www.siemens.com/sinamics-g120x](http://www.siemens.com/sinamics-g120x)

You can access our Interactive Catalog and our Industry Mall on the Internet at:  
[www.siemens.com/industrymall](http://www.siemens.com/industrymall)

Your personal contact will be glad to receive your suggestions and recommendations for improvement. You can find your representative in our personal contacts database at  
[www.siemens.com/automation-contact](http://www.siemens.com/automation-contact)

We hope that you will often enjoy using Catalog D 31.5 as a selection and ordering reference document and wish you every success with our products and solutions.

With kind regards,



Achim Peltz  
Vice President  
General Motion Control  
Siemens AG, Digital Factory, Motion Control



# SINAMICS Converters for Single-Axis Drives

## SINAMICS G120X infrastructure converters for HVAC/Water/Wastewater

### Motion Control Drives



### Catalog D 31.5 · February 2019

Refer to the Industry Mall for current updates of this catalog:

[www.siemens.com/industrymall](http://www.siemens.com/industrymall)

The products contained in this catalog can also be found in the Interactive Catalog CA 01.

Article No.: E86060-D4001-A510-D8-7500

Please contact your local Siemens branch.

© Siemens AG 2019

### NEW

Click on an Article No. in the catalog PDF to call it up in the Industry Mall and to obtain all the information.

Article No.

6SL3070-0AA00-0AG0  
6SL3072-0AA00-0AG0



Or directly on the Internet, e.g.  
[www.siemens.com/product?6SL3070-0AA00-0AG0](http://www.siemens.com/product?6SL3070-0AA00-0AG0)



The products and systems described in this catalog are manufactured/distributed under application of a certified quality management system in accordance with EN ISO 9001. The certificate is recognized by all IQNet countries.

### System overview

1

### SINAMICS G120X infrastructure converters for HVAC/Water/Wastewater

2

### Engineering tools

3

### Services and documentation

4

### Appendix

5

# Digital Enterprise

The building blocks that ensure everything works together perfectly in the digital enterprise

Digitalization is already changing all areas of life and existing business models. It is placing greater pressure on industry while at the same time creating new business opportunities. Today, thanks to scalable solutions from Siemens, companies can already become a digital enterprise and ensure their competitiveness.



## Industry faces tremendous challenges



### Reduce time-to-market

Today manufacturers have to bring products to market at an ever-increasing pace despite the growing complexity of these products. In the past, a major manufacturer would push aside a small one, but now it is a fast manufacturer that overtakes a slow one.



### Boost flexibility

Consumers want customized products, but at a price they would pay for a mass-produced item. That only works if production is more flexible than ever before.



### Improve quality

To ensure a high level of quality while meeting legal requirements, companies have to establish closed quality loops and enable the traceability of products.



### Boost efficiency

Today the product itself needs to be sustainable and environmentally friendly, while energy efficiency in production has become a competitive advantage.



### Increase security

Increasing networking escalates the threat to production facilities of cyberattacks. Today more than ever, companies need suitable security measures.



## The digital enterprise has already become a reality

To fully benefit from all the advantages of digitalization, companies first have to achieve complete consistency of their data. Fully digitally integrated business processes, including those of suppliers, can help to create a digital representation of the entire value chain. This requires

- the integration of industrial software and automation,
- expansion of the communication networks,
- security in automation,
- and the use of business-specific industrial services.

## MindSphere

### The cloud-based open IoT operating system from Siemens

With MindSphere, Siemens offers a cost-effective and scalable cloud platform as a service (PaaS) for the development of applications. The platform, designed as an open operating system for the Internet of Things, makes it possible to improve the efficiency of plants by collecting and analyzing large volumes of production data.

### Totally Integrated Automation (TIA) Where digitalization becomes reality

Totally Integrated Automation (TIA) ensures the seamless transition from the virtual to the real world. It already encompasses all the necessary conditions for transforming the benefits of digitalization into true added value. The data that will form the digital twin for actual production is generated from a common base.

### Digital Plant

Learn more about the digital enterprise for the process industry  
[www.siemens.com/digitalplant](http://www.siemens.com/digitalplant)

### Digital Enterprise Suite

Learn more about the digital enterprise for the discrete industry  
[www.siemens.com/digital-enterprise-suite](http://www.siemens.com/digital-enterprise-suite)

# Integrated Drive Systems

Faster on the market and in the black with Integrated Drive Systems

Integrated Drive Systems are Siemens' trendsetting answer to the high degree of complexity that characterizes drive and automation technology today. The world's only true one-stop solution for entire drive systems is characterized in particular by its threefold integration: Horizontal, vertical, and lifecycle integration ensure that every drive system component fits seamlessly into the whole system, into any automation environment, and even into the entire lifecycle of a plant.

The outcome is an optimal workflow – from engineering all the way to service that entails more productivity, increased efficiency, and better availability. That's how Integrated Drive Systems reduce time to market and time to profit.

## Horizontal integration

**Integrated drive portfolio:** The core elements of a fully integrated drive portfolio are frequency converters, motors, couplings, and gear units. At Siemens, they're all available from a single source. Perfectly integrated, perfectly interacting. For all power and performance classes. As standard solutions or fully customized. No other player in the market can offer a comparable portfolio. Moreover, all Siemens drive components are perfectly matched, so they are optimally interacting.

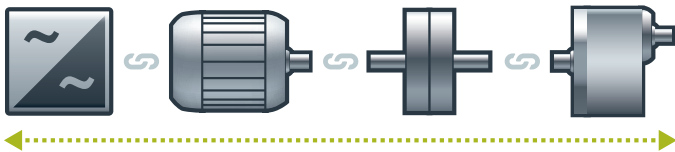

You can boost the availability of your application or plant to up to

**99%\***  
\*e.g., conveyor application

## Vertical integration

Thanks to **vertical integration**, the complete drive train is seamlessly integrated in the entire automation environment – an important prerequisite for production with maximum value added. Integrated Drive Systems are part of Totally Integrated Automation (TIA), which means that they are perfectly embedded into the system architecture of the entire industrial production process. This enables optimal processes through maximum communication and control.

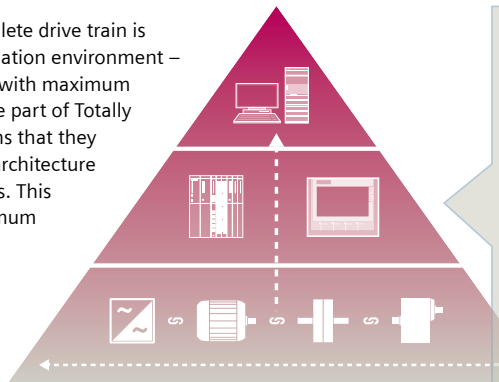

With TIA Portal you can cut your engineering time by up to

**30%**

## Lifecycle integration

**Lifecycle integration** adds the factor of time: Software and service are available for the entire lifecycle of an Integrated Drive System. That way, important optimization potential for maximum productivity, increased efficiency, and highest availability can be leveraged throughout the system's lifecycle – from planning, design, and engineering to operation, maintenance, and all the way even to modernization.

With Integrated Drive Systems, assets become important success factors. They ensure shorter time to market, maximum productivity and efficiency in operation, and shorter time to profit.

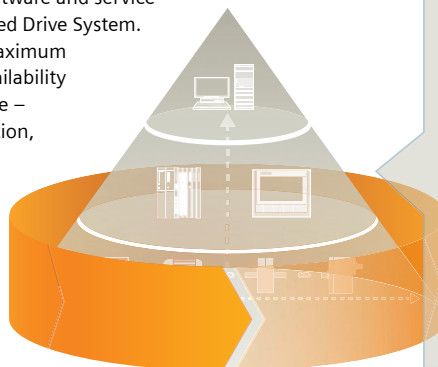

With Integrated Drive Systems you can reduce your maintenance costs by up to

**15%**



## System overview



1/2	<b>The SINAMICS drives family</b>
1/6	<b>Drive selection</b>
1/7	<b>SIMOTICS motors</b>
1/8	<b>SIMOTICS low-voltage motors for line and converter operation</b>
1/9	<b>Energy efficiency classes in accordance with EN 50598</b>
1/12	<b>SINAMICS G120X infrastructure converters for HVAC/Water/Wastewater</b>
1/14	<b>SINAMICS G120X Starter Kits</b>

Further information about SINAMICS and SIMOTICS can be found on the Internet at [www.siemens.com/sinamics](http://www.siemens.com/sinamics) and [www.siemens.com/simotics](http://www.siemens.com/simotics)

# System overview

## The SINAMICS drives family

### Overview

#### Integration in automation

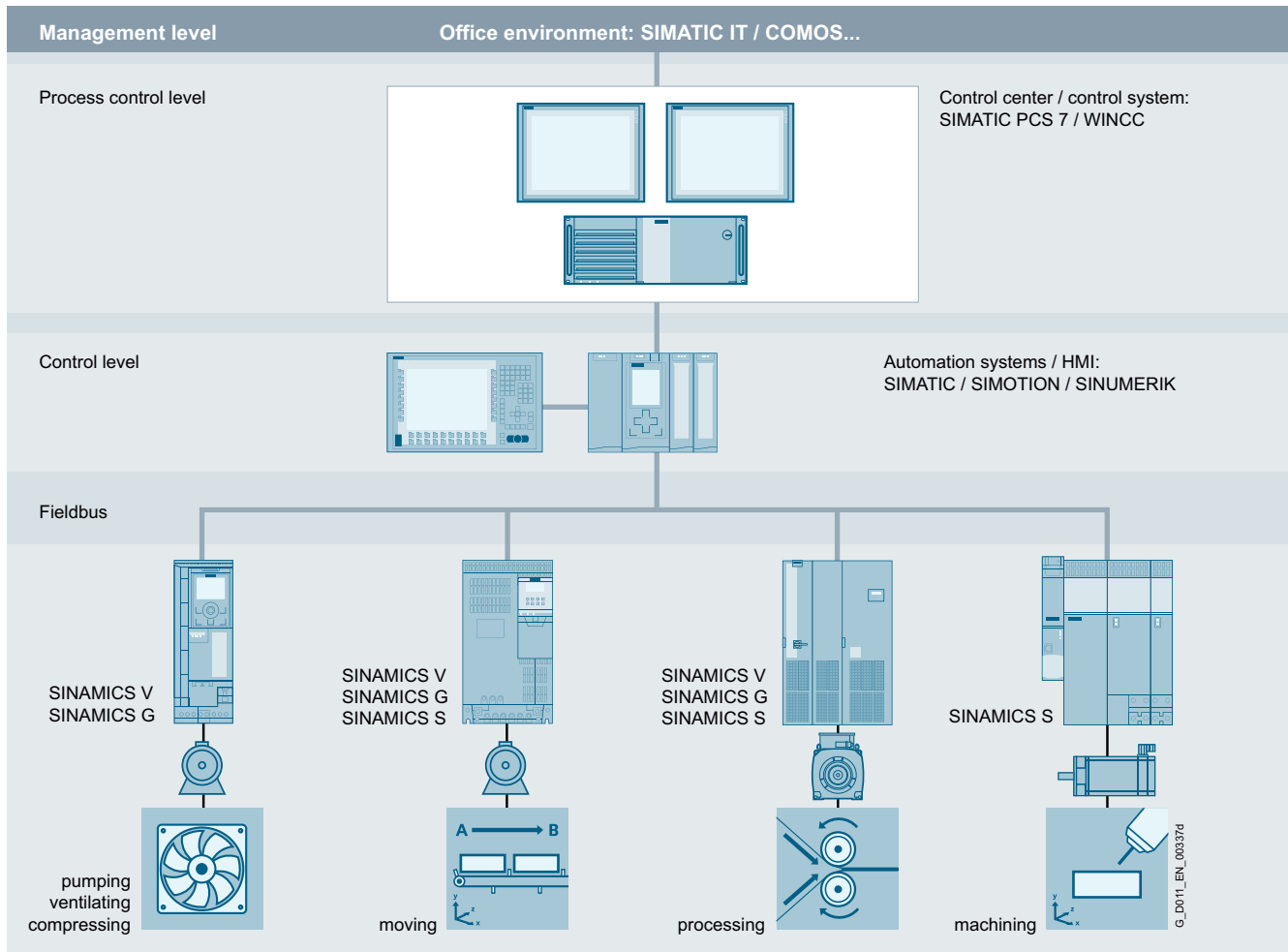

#### Totally Integrated Automation and communication

SINAMICS is an integral component of the Siemens "Totally Integrated Automation" concept. Integrated SINAMICS systems covering configuration, data storage, and communication at automation level ensure low-maintenance solutions with the SIMATIC, SIMOTION and SINUMERIK control systems.

Depending on the application, the appropriate variable frequency drives can be selected and incorporated in the automation concept. With this in mind, the drives are clearly subdivided into their different applications. A wide range of communication options (depending on the drive type) are available for establishing a communication link to the automation system:

- PROFINET
- PROFIBUS
- EtherNet/IP
- Modbus TCP
- Modbus RTU
- AS-Interface
- BACnet MS/TP

#### Applications

SINAMICS is the comprehensive family of drives from Siemens designed for machine and plant engineering applications. SINAMICS offers solutions for all drive tasks:

- Simple pump and fan applications in the process industry
- Demanding single drives in centrifuges, presses, extruders, elevators, as well as conveyor and transport systems
- Drive line-ups in textile, plastic film, and paper machines as well as in rolling mill plants
- Highly dynamic servo drives for machine tools, as well as packaging and printing machines

**Overview** (continued)*SINAMICS as part of the Siemens modular automation system****Innovative, energy-efficient and reliable drive systems and applications as well as services for the entire drive train***

The solutions for drive technology place great emphasis on the highest productivity, energy efficiency and reliability for all torque ranges, performance and voltage classes.

Siemens offers not only the right innovative variable frequency drive for every drive application, but also a wide range of energy-efficient low-voltage motors, geared motors, explosion-protected motors and high-voltage motors for combination with SINAMICS.

Furthermore, Siemens supports its customers with global pre-sales and after-sales services, with over 295 service points in 130 countries – and with special services e.g. application consulting or motion control solutions.

***Energy efficiency*****Energy management process**

Efficient energy management consultancy identifies the energy flows, determines the potential for making savings and implements them with focused activities.

Almost two thirds of the industrial power requirement is from electric motors. This makes it all the more important to use drive technology permitting energy consumption to be reduced effectively even in the configuration phase, and consequently to optimize plant availability and process stability. With SINAMICS, Siemens offers powerful energy efficient solutions which, depending on the application, enable a significant reduction in electricity costs.

G\_D011\_XX\_00515b

## System overview

### The SINAMICS drives family

#### Overview (continued)

##### Up to 70 % potential for savings using variable-speed operation

SINAMICS enables great potential for savings to be realized by controlling the motor speed. In particular, huge potential savings can be recovered from pumps, fans and compressors which are operated with mechanical throttle and valves. Here, changing to variable-speed drives brings enormous economic advantages. In contrast to mechanical control systems, the power consumption at partial load operation is always immediately adjusted to the demand at that time. So energy is no longer wasted, permitting savings of up to 60 % – in exceptional cases even up to 70 %. Variable-speed drives also offer clear advantages over mechanical control systems when it comes to maintenance and repair. Current spikes when starting up the motor and strong torque surges become things of the past – and the same goes for pressure waves in pipelines, cavitation or vibrations which cause sustainable damage to the plant. Smooth starting and ramp-down relieve the load on the mechanical system, ensuring a significantly longer service life of the entire drive train.

##### Regenerative feedback of braking energy

In conventional drive systems, the energy produced during braking is converted to heat using braking resistors. Energy produced during braking is efficiently recovered to the supply system by versions of SINAMICS G and SINAMICS S drives with regenerative feedback capability and these devices do not therefore need a braking resistor. This permits up to 60 % of the energy requirement to be saved, e.g. in lifting applications. Energy which can be reused at other locations on a machine. Furthermore, this reduced power loss simplifies the cooling of the system, enabling a more compact design.

##### Energy transparency in all configuration phases

Early on, in the configuration phase, the SIZER for Siemens Drives engineering tool provides information on the specific energy requirement. The energy consumption across the entire drive train is visualized and compared with different plant concepts.

##### SINAMICS in combination with energy-saving motors

Engineering integration stretches beyond the SINAMICS drive family to higher-level automation systems, and to a broad spectrum of energy-efficient motors with a wide range of performance classes, which, compared to previous motors, are able to demonstrate up to 10 % greater efficiency.

#### Variants

Depending on the application, the SINAMICS range offers the ideal variant for any drive task.

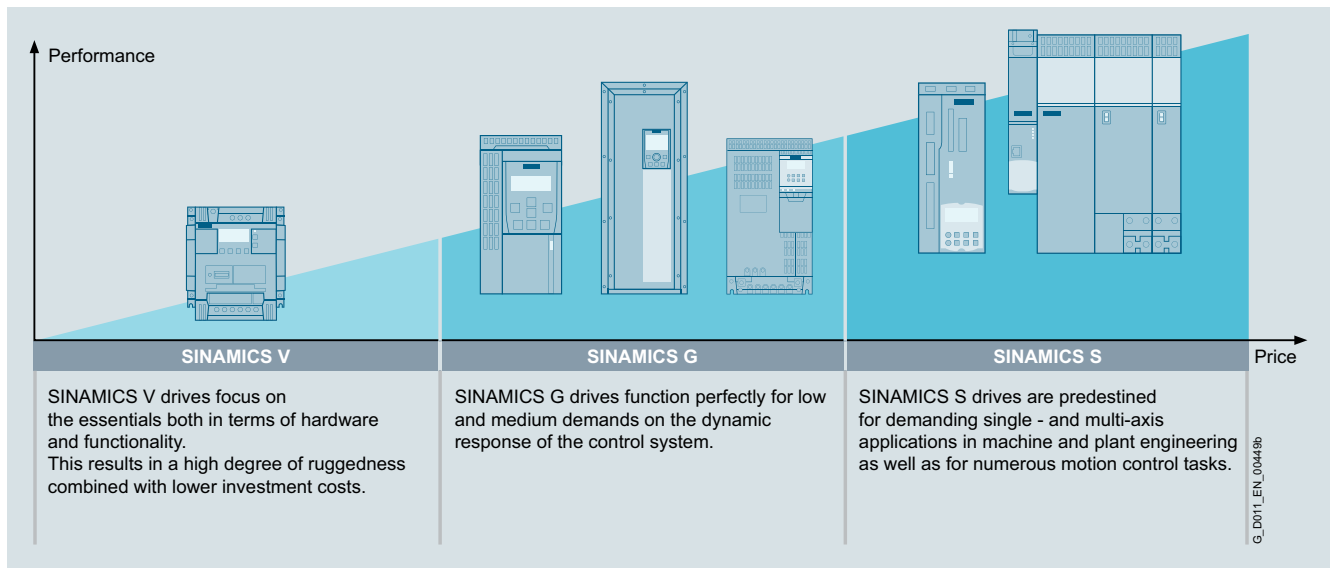

**Overview** (continued)**Platform concept**

All SINAMICS variants are based on a platform concept. Joint hardware and software components, as well as standardized tools for dimensioning, configuration, and commissioning tasks ensure high-level integration across all components. SINAMICS handles a wide variety of drive tasks with no system gaps. The different SINAMICS variants can be easily combined with each other.











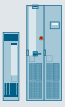

**Quality management according to EN ISO 9001**

SINAMICS conforms to the most exacting quality requirements. Comprehensive quality assurance measures in all development and production processes ensure a consistently high level of quality.

Of course, our quality management system is certified by an independent authority in accordance with EN ISO 9001.

**IDS – Integration at its very best**

The Siemens Integrated Drive Systems (IDS) solution offers perfectly matched drive components with which you can meet your requirements. The drive components reveal their true strengths as an Integrated Drive System over the full range from engineering and commissioning through to operation: Integrated system configuration is performed using the Drive Technology Configurator: Just select a motor and an converter and design them with the SIZER for Siemens Drives engineering tool. The STARTER and SINAMICS Startdrive commissioning tools integrate the motor data and at the same time simplify efficient commissioning. Integrated Drive Systems are incorporated in the TIA Portal – this simplifies engineering, commissioning and diagnostics.

Low voltage										DC voltage	Medium voltage
Basic performance		General performance					High performance			DC applications	Applications with high outputs
											
SINAMICS V20	SINAMICS V90	SINAMICS G120C G120 G120X	SINAMICS G110D G120D G110M SIMATIC ET 200pro FC-2	SINAMICS G130 G150	SINAMICS G180	SINAMICS S110	SINAMICS S210	SINAMICS S120 S120M	SINAMICS S150	SINAMICS DCM	SINAMICS GH150 GH180 GM150 SM150 GL150 SL150 SM120CM
0.12 kW to 30 kW	0.05 kW to 7 kW	0.37 kW to 630 kW	0.37 kW to 7.5 kW	75 kW to 2700 kW	2.2 kW to 6600 kW	0.55 kW to 132 kW	0.05 kW to 7 kW	0.55 kW to 5700 kW	75 kW to 1200 kW	6 kW to 30 MW	0.15 MW to 85 MW
Pumps, fans, compressors, conveyor belts, mixers, mills, spinning machines, textile machines, refrigerated display counters, fitness equipment, ventilation systems	Handling machines, packaging machines, automatic assembly machines, metal forming machines, printing machines, winding and unwinding units	Pumps, fans, compressors, conveyor belts, mixers, mills, extruders, building management systems, process industry, HVAC, single-axis positioning applications in machine and plant engineering	Conveyor technology, single-axis positioning applications (G120D)	Pumps, fans, compressors, conveyor belts, mixers, mills, extruders	Sector-specific for pumps, fans, compressors, conveyor belts, extruders, mixers, mills, kneaders, centrifuges, separators	Single-axis positioning applications in machine and plant engineering	Packaging machines, handling equipment, feed and withdrawal devices, stacking units, automatic assembly machines, laboratory automation, wood, glass and ceramics industry, digital printing machines	Production machines (packaging, textile and printing machines, paper machines, plastic processing machines), machine tools, plants, process lines and rolling mills, marine drives, test bays	Test bays, cross cutters, centrifuges	Rolling mill drives, wire-drawing machines, extruders and kneaders, cableways and lifts, test bay drives	Pumps, fans, compressors, mixers, extruders, mills, crushers, rolling mills, conveyor technology, excavators, test bays, marine drives, blast furnace fans, retrofit
Catalog D 31.1	Catalog D 33	Catalogs D 31.1, D 31.5	Catalog D 31.2	Catalog D 11	Catalog D 18.1	Catalog D 31.1	Catalog D 32	Catalogs D 21.3, D 21.4 NC 62	Catalog D 21.3	Catalog D 23.1	Catalogs D 15.1, D 12
Engineering tools (e.g. Drive Technology Configurator, SIZER for Siemens Drives, STARTER and SINAMICS Startdrive)											

G\_D011\_EN\_00450m

# System overview

## Drive selection

1

### Overview

#### SINAMICS selection guide – typical applications

Use	Requirements for torque accuracy/speed accuracy/position accuracy/coordination of axes/functionality					
	Continuous motion			Non-continuous motion		
	Basic	Medium	High	Basic	Medium	High
<b>Pumping, ventilating, compressing</b> 	Centrifugal pumps Radial / axial fans Compressors  V20 G120C <b>G120X</b>	Centrifugal pumps Radial / axial fans Compressors  <b>G120X</b> G130/G150 G180 <sup>1)</sup>	Eccentric screw pumps  S120	Hydraulic pumps Metering pumps  G120	Hydraulic pumps Metering pumps  S110	Descaling pumps Hydraulic pumps  S120
	<b>Moving</b> 	Conveyor belts Roller conveyors Chain conveyors  V20 G110D G110M G120C ET 200pro FC-2 <sup>2)</sup>	Conveyor belts Roller conveyors Chain conveyors Lifting/lowering devices Elevators Escalators/moving walkways Indoor cranes Marine drives Cable railways  G120 G120D G130/G150 G180 <sup>1)</sup>	Elevators Container cranes Mining hoists Excavators for open-cast mining Test bays  S120 S150 DCM	Acceleration conveyors Storage and retrieval machines  V90 G120 G120D	Acceleration conveyors Storage and retrieval machines Cross cutters Reel changers  S110 S210 DCM
<b>Processing</b> 	Mills Mixers Kneaders Crushers Agitators Centrifuges  V20 G120C	Mills Mixers Kneaders Crushers Agitators Centrifuges Extruders Rotary furnaces  G120 G130/G150 G180 <sup>1)</sup>	Extruders Winders/unwinders Lead/follower drives Calenders Main press drives Printing machines  S120 S150 DCM	Tubular bagging machines Single-axis motion control such as • Position profiles • Path profiles  V90 G120	Tubular bagging machines Single-axis motion control such as • Position profiles • Path profiles  S110 S210	Servo presses Rolling mill drives Multi-axis motion control such as • Multi-axis positioning • Cams • Interpolations  S120 S210 DCM
	<b>Machining</b> 	Main drives for • Turning • Milling • Drilling  S110	Main drives for • Drilling • Sawing  S110 S120	Main drives for • Turning • Milling • Drilling • Gear cutting • Grinding  S120	Axis drives for • Turning • Milling • Drilling  S110	Axis drives for • Drilling • Sawing  S110 S120

#### Using the SINAMICS selection guide

The varying range of demands on modern variable frequency drives requires a large number of different types. Selecting the optimum drive has become a significantly more complex process. The application matrix shown simplifies this selection process considerably, by suggesting the ideal SINAMICS drive for examples of typical applications and requirements.

- The application type is selected from the vertical column
  - Pumping, ventilating, compressing
  - Moving
  - Processing
  - Machining
- The quality of the motion type is selected from the horizontal row
  - Basic
  - Medium
  - High

#### More information







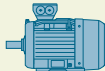

Further information about SINAMICS is available on the Internet at [www.siemens.com/sinamics](http://www.siemens.com/sinamics)

Practical application examples and descriptions are available on the Internet at [www.siemens.com/sinamics-applications](http://www.siemens.com/sinamics-applications)

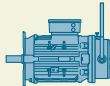
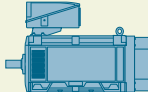
<sup>1)</sup> Industry-specific converters.

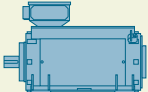
<sup>2)</sup> Information on the SIMATIC ET 200pro FC-2 frequency converter is available in Catalog D 31.2 and at [www.siemens.com/et200pro-fc](http://www.siemens.com/et200pro-fc)

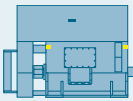
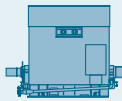
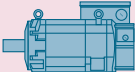
## Overview

SIMOTICS						
Low-voltage motors for line and converter operation						
General Purpose SIMOTICS GP	Severe Duty SIMOTICS SD	Explosion-proof SIMOTICS XP	Definite Purpose SIMOTICS DP	Flexible Duty SIMOTICS FD	Non standard SIMOTICS TN	High Torque SIMOTICS HT
						
DC motors		High-voltage motors				
Direct current SIMOTICS DC		High Voltage SIMOTICS HV				
						
Motors for motion control						
SIMOTICS S servomotors		SIMOTICS M main motors		SIMOTICS L linear motors		SIMOTICS T torque motors
Servomotors	Servo geared motors					

G.D011\_EN\_09491

**SIMOTICS stands for**

- 150 years of experience in building electric motors
- The most comprehensive range of motors worldwide
- Optimum solutions in all industries, regions and power/performance classes
- Innovative motor technologies of the highest quality and reliability
- Highest dynamic performance, precision and efficiency together with the optimum degree of compactness
- Our motors can be integrated into the drive train as part of the overall system
- A global network of skill sets and worldwide service around the clock

**A clearly structured portfolio**

The entire SIMOTICS product portfolio is transparently organized according to application-specific criteria in order to help users select the optimum motor for their application.

The product range extends from standard motors for pumps, fans and compressors to highly dynamic, precise motion control motors for positioning tasks and motion control in handling applications, as well as production machinery and machine tools, to DC motors and powerful high-voltage motors. Whatever it is that you want to move – we can supply the right motor for the task.

[www.siemens.com/simotics](http://www.siemens.com/simotics)

**An outstanding performance for any job**

A key characteristic of all SIMOTICS motors is their quality. They are robust, reliable, dynamic and precise to assure the requisite performance level for any process and deliver exactly the capabilities demanded by the application in hand. Thanks to their compact design, they can be integrated as space-saving units into installations. Furthermore, their impressive energy efficiency makes them effective as a means of reducing operating costs and protecting the environment.

**A dense network of skill sets and servicing expertise around the world**

SIMOTICS offers not only a wealth of sound experience gleaned from a development history which stretches back over around 150 years, but also the know-how of hundreds of engineers. This knowledge and our worldwide presence form the basis for a unique proximity to industries which feeds through in tangible terms to the specific motor configuration which is tailored to suit your application.

Our specialists are available to answer all your queries regarding any aspect of motor technology. At any time – wherever you are in the world. When you choose SIMOTICS, therefore, you reap the benefits of a global service network which is continuously accessible, thereby helping to optimize response times and minimize downtimes.







**Perfection of the complete drive train**

SIMOTICS is perfectly coordinated with other Siemens product families. In combination with the SINAMICS integrated drives family and the SIRIUS complete portfolio of industrial controls, SIMOTICS fits seamlessly as part of the complete drive train into automation solutions which are based on the SIMATIC, SIMOTION and SINUMERIK control systems.

# System overview

## SIMOTICS low-voltage motors for line and converter operation

### Overview

Low-voltage motors for mains and converter operation						
General Purpose SIMOTICS GP	Severe Duty SIMOTICS SD	Explosion Proof SIMOTICS XP	Definite Purpose SIMOTICS DP	Transnom SIMOTICS TN	Flexible Duty SIMOTICS FD	High Torque SIMOTICS HT
						
IEC: 0.09 ... 45 kW  Reluctance: 0.55 ... 48 kW  NEMA: 1 ... 20 hp	IEC: 0.09 ... 315 kW  Reluctance: 0.55 ... 48 kW  NEMA: 1 ... 400 hp	IEC: 0.09 ... 1 000 kW  NEMA: 1 ... 300 hp	IEC: 0.09 ... 481 kW  NEMA: 1 ... 250 hp	200 ... 3 500 kW	200 ... 1 800 kW	150 ... 2 100 kW
IEC: 0.61 ... 293.8 Nm  Reluctance: 3.5 ... 191 Nm  NEMA: 1.5 ... 60 lb-ft	IEC: 1.3 ... 2 070 Nm  Reluctance: 3.5 ... 191 Nm  NEMA: 1.5 ... 1 483 lb-ft	IEC: 0.61 ... 8 090 Nm  NEMA: 1.5 ... 1 187 lb-ft	IEC: 2.5 ... 3 142 Nm  NEMA: 1.5 ... 1 104 lb-ft	800 ... 22 500 Nm	610 ... 14 600 Nm	6 000 ... 42 000 Nm
IEC: 750 ... 3 000 rpm (at 50 Hz)  Reluctance: 1 500/1 800/2 610 rpm  NEMA: 900 ... 3 600 rpm (at 60 Hz)	IEC: 750 ... 3 000 rpm (at 50 Hz)  Reluctance: 1500/1800/2610 /3000/3600 rpm  NEMA: 900 ... 3 600 rpm (at 60 Hz)	IEC: 750 ... 3 000 rpm (at 50 Hz)  NEMA: 900 ... 3 600 rpm (at 60 Hz)	IEC: 750 ... 3 000 rpm (at 50 Hz)  NEMA: 900 ... 3 600 rpm (at 60 Hz)	IEC: 750 ... 3 000 rpm (at 50 Hz)	IEC: 750 ... 3 000 rpm (at 50 Hz)	IEC: 200 ... 800 rpm (at 50 Hz)
Pumps, fans and compressors with especially low weight requirements	Pumps, fans, compressors, mixers, mills, extruders and rollers with special demands in terms of ruggedness, particularly in the chemical and petrochemical industries	General industrial applications with special requirements regarding explosion protection for use in Zones 1, 2, 21, and 22 such as in the process industry	Ships, work and transport roller tables, tunnels, multi-story car parks, shopping malls, dockside cranes, container terminals as well as motors customized for special applications	Pumps, fans, compressors, conveyor belts, mixers, extruders in the chem. and petrochem. industry, paper-making machines, mining, cement, steel industry, and marine applications including propulsion	Pumps, fans, compressors, conveyor belts, centrifuges, extruders, winders, hoisting gear in cranes, presses, paper machines, rolling mills, marine applications including propulsion	High-torque gearless motors for paper-making machines, low-speed pumps, mills, steel shears, bow thrusters, winches or main drives on ships
IEC: D 81.1 NEMA: D 81.2	IEC: D 81.1 NEMA: D 81.2	IEC: D 81.1, D 83.1 NEMA: D 81.2	IEC: D 81.1 NEMA: D 81.2	D 81.1, D 84.1	D 81.8	D 86.2

G\_D011\_EN\_00565

### SIMOTICS GP and SIMOTICS SD

SIMOTICS GP General Purpose motors with an aluminum housing are suitable for a wide range of standard drive tasks in industrial environments. SIMOTICS SD Severe Duty motors with a cast-iron housing are extremely rugged and are therefore the first choice for applications in harsh environmental conditions.

SIMOTICS GP and SIMOTICS SD are fundamentally optimized for line operation. In addition, two converter-optimized motor lines are available for variable-speed converter-fed operation.

#### • Induction technology (VSD10 line)

The VSD10 line converter motors are designed exclusively for use on converters and are specially optimized for SINAMICS frequency converters. In terms of economy, efficiency and reliability, they are perfectly matched to SINAMICS G120 standard converters over the complete life cycle.

#### • Synchronous reluctance technology (VSD4000 line)

VSD4000 line reluctance motors are designed exclusively for use on converters and are specially optimized for SINAMICS G120. Compared to systems with induction motors, synchronous reluctance technology is characterized by particularly high efficiency levels, especially in the partial load range, and by high dynamics. The vector control of the frequency converter ensures optimal operating characteristics. More information on the reluctance drive system is available at

[www.siemens.com/reluctance-drive-system](http://www.siemens.com/reluctance-drive-system)



## Overview

### Step by step to more efficiency

One of the core objectives of the European Union is a sustainable power industry. In industrial plants today, around 70 % of the power demand is from electrically driven systems. This high percentage contains huge potential for saving energy in electrical drives. For that reason, the European Union introduced minimum requirements for the energy efficiency of electric motors in the form of a statutory motor regulation as early as 2011.

However, measures aimed solely at the motor are not enough to achieve the mandatory energy-saving targets. The European legislation fills this gap with the standard series EN 50598 and extends the focus from individual drive components to entire drive systems, even enabling consideration of specific use cases.

The European standard series EN 50598 defines the ecodesign requirements for drive systems in the low-voltage range with an electrically driven machine. It consists of definitions for energy efficiency (parts 1 and 2) and an ecobalance calculation (part 3).

To take account of the different use cases, consideration of eight application-relevant operating points has been introduced as mandatory for the first time. Determination of loss values at these eight points and definition of efficiency classes are laid down by the standard in a uniform way. This enables data relevant to operation, such as application-specific load profiles, to now be taken into account more easily in the energy efficiency analysis.

The standard is especially important for variable-speed drives of the following types:

- for AC/AC converters without energy recovery functionality
- for motors with integrated converters
- for supply voltages of 100 V to 1000 V
- for power ratings of 0.12 kW to 1000 kW

To cover all applications of driven machines, the new standard defines operating points in full-load and partial-load operation, at which the losses of the motor and drive systems have to be determined. Based on the loss data at the operating points in partial-load operation, variable-speed drives can be explicitly considered in more detail. This makes their advantages especially clear.

### Centrifugal pumps, fans

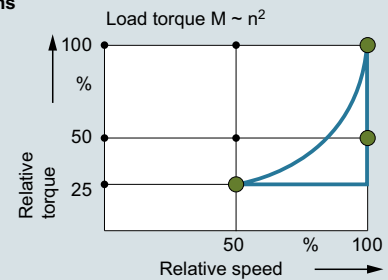

### Hoisting gear, extruders, conveyor belts

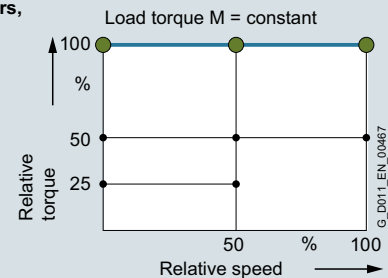

### Winders, coilers

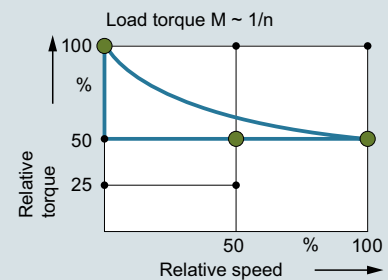

### Duty cycles for different driven machines

Moreover, frequency converters and motor systems are classified in efficiency classes, which permit an initial rough estimate of the potential saving. Definition of reference systems is a key aspect of this because they provide standard reference values. The positioning of these reference systems defines the efficiency class. The relative distance from the reference system can be used as an absolute measure of the efficiency at the operating point in question.

## System overview

1

### Energy efficiency classes in accordance with EN 50598

#### Overview (continued)

##### *Advantages of the detailed loss consideration of EN 50598 over the previous consideration of efficiencies and maximum loss values*

For motors, the efficiency consideration was previously only defined for operation without a converter at 50/60 Hz. It provides a good way of comparing the energy efficiency of motors from different manufacturers for this use case.

The more detailed loss analysis of EN 50598, on the other hand, is aimed at speed-controlled operation and therefore now also includes motors especially designed for converter operation in the energy analysis. These were previously not covered by the applicable standards.

Moreover, a loss analysis over the entire setting and load range of the motor is possible. This is done in accordance with the standard EN 50598 with typical values.

For holistic consideration, it is essential to include all the relevant components of a drive system. The EN 50598 standard defines this in detail. The standardized expression of power loss data as a percentage makes comparison considerably easier and more transparent.

The method also makes it possible to consider a motor that produces a holding torque at speed zero, for example. In this case, the efficiency is zero, but a power loss from current producing magnetization and holding torque does occur. In summary, the key advantage of standard EN 50598 is the ability to perform the energy analysis of an electrical drive system based on standardized load profiles in all operating ranges due to uniform general conditions. This provides the user with complete transparency irrespective of the manufacturer.

##### *Establishing efficiency classes of frequency converters (Complete Drive Modules CDM)*

To avoid overmodulation and to ensure comparability between makes, which cannot be achieved otherwise, the efficiency classes of CDMs refer to the 90/100 operating point (90 % motor stator frequency, 100 % torque current).

Standard EN 50598-2 defines the relative losses of a CDM in efficiency classes IE0 to IE2. With reference to the value of a CDM of efficiency class IE1 (reference converter), a CDM of efficiency class IE2 has 25 % lower losses and a CDM of efficiency class IE0 has 25 % higher losses.

##### Operating points for CDMs

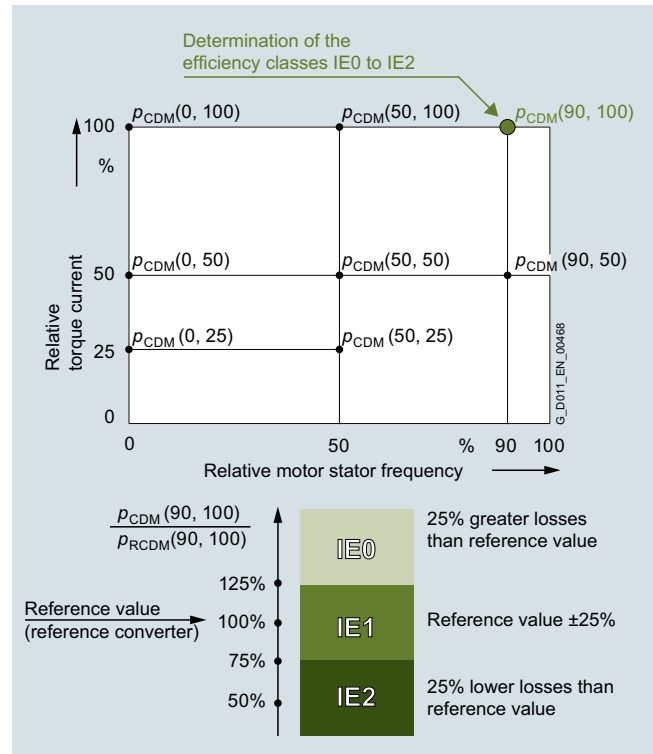

Complete Drive Module (CDM) – determining the efficiency class

##### *Establishing the efficiency classes of drive systems (Power Drive Systems PDS)*

What is possible for the individual systems, of course, also applies to the entire electrical PDS (frequency converter plus motor). Detailed comparisons are now possible at this level, too. The reference values for the reference system provide clear indications of the energy performance of the PDS.

Because targeted matching of the motor and CDM provides additional potential for optimization in electrical drive systems, it is especially important for the user to consider the entire drive system.

For the efficiency class of a PDS, too, a specific load point is defined. In this case, the reference point used is the 100/100 operating point (100 % motor stator frequency, 100 % torque).

Standard EN 50598-2 defines the relative losses of a PDS in efficiency classes IES0 to IES2. With reference to the value of a PDS of efficiency class IES1 (reference drive), a PDS of efficiency class IES2 has 20 % lower losses and a PDS of efficiency class IES0 has 20 % higher losses.

Energy efficiency classes in accordance with EN 50598

Overview (continued)

Operating points for PDS

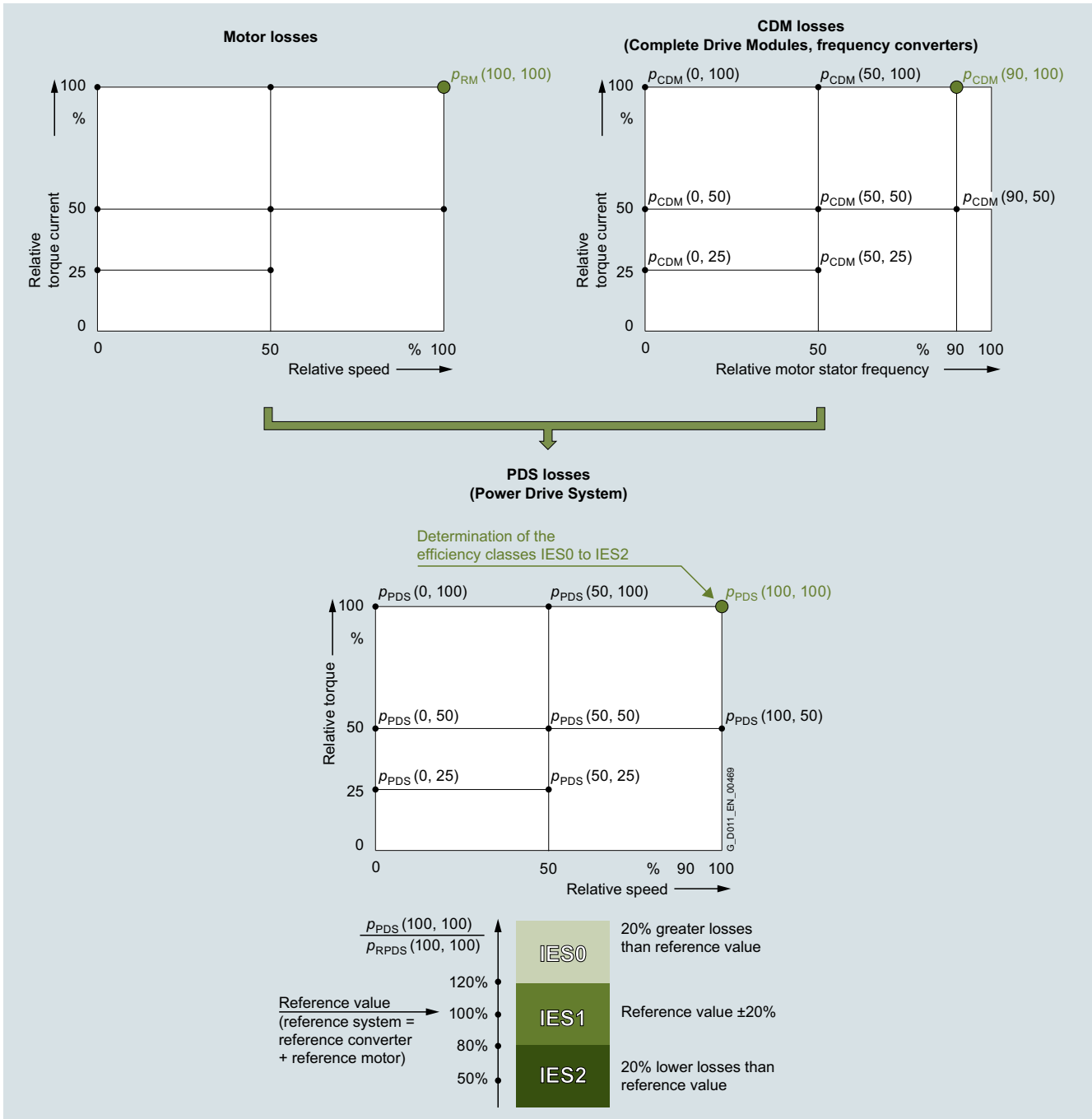

Power Drive System (PDS) – determining the efficiency class

More information

An example of a highly efficient drive system with efficiency class IES2 is the new synchronous inductance drive system with SIMOTICS reluctance motors and SINAMICS drives. More information is available on the Internet at [www.siemens.com/drivesystem-reluctance](http://www.siemens.com/drivesystem-reluctance), [www.siemens.com/simotics-gp](http://www.siemens.com/simotics-gp), [www.siemens.com/simotics-sd](http://www.siemens.com/simotics-sd)

Power loss data of SINAMICS converters for single-axis drives are available on the Internet at <https://support.industry.siemens.com/cs/document/94059311>

More information on current laws and standards, new standards, and mandatory guidelines is available on the Internet at [www.siemens.com/legislation-and-standards](http://www.siemens.com/legislation-and-standards)

## System overview

### SINAMICS G120X infrastructure converters for HVAC/Water/Wastewater

1

#### Overview



SINAMICS G120X, frame sizes FSA to FSJ, degree of protection IP20, with IOP-2 Intelligent Operator Panel

Easy handling, utmost reliability, superior efficiency and advanced digitalization - Siemens offers an answer to these trends with the SINAMICS G120X converter series. SINAMICS G120X is an innovative and user-friendly converter series that has been specifically developed for applications performed in infrastructure environments such as water/wastewater, but also for tasks in building automation. In this context, the converter supports, for example, pump, fan and compressor applications through numerous integrated functionalities and combines these in one device for the target sectors.

The SINAMICS G120X converter is an integrated and efficient drive solution for a wide range of tasks. The system allows convenient handling through optimized user interfaces: IOP-2 Intelligent Operator Panel with graphic color display and the optional web server module SINAMICS G120 Smart Access - a WLAN-based web server solution. Thus, the SINAMICS G120X fulfils the request for an easy and fast setup of the devices during the commissioning phase. Further, experienced users can use the full flexibility of a SINAMICS converter and adjust the relevant application to their requirements.

Totally integrated operation - this approach is also supported from ordering through to delivery.

For example, all the major features of the converter are configured and displayed in the article number. The delivery includes the complete device - as configured - that means, the converter and the selected operator panel.

In addition, SINAMICS G120X has an extremely rugged and reliable construction. The integrated DC link reactor with a maximum output of 250 kW and optional resistance to harmful gases up to environmental class 3C3 ensure a reliable, stable and largely robust operation.

The converter system is fit for digitalization. Thanks to its full integration in the SINAMICS CONNECT 300 system, data from up to eight converters can be acquired and transferred to the MindSphere cloud solution. The MindSphere application "Analyze MyDrives" facilitates the evaluation of data - tailored to individual customer needs. This simplifies the acquisition and evaluation of converter conditions.

Further, the SINAMICS G120X converter series provides innovative hardware and software functions, e.g. for controlling synchronous reluctance drive systems with SIMOTICS reluctance motors. In this way, the SINAMICS G120X converter series makes a substantial contribution towards saving energy and makes more careful use of our natural resources.

#### User-friendliness

A high degree of user-friendliness is one of the main characteristics of the SINAMICS G120X:

- Operator panel with color display and extensive diagnostics functions (IOP-2 Intelligent Operator Panel)
- Two different setup options are available: Standard and quick start with graphical user guidance
- Optimized setups for pumps and fans in the web server module SINAMICS G120 Smart Access
- SINAMICS SD card for storing parameter settings, cloning and local commissioning

#### Integrated functionalities for the start/operational/stop phases of the application

SINAMICS G120X is always preset, depending on the selected converter performance. Further, the following functions can be easily selected and parameterized:

##### Start phase

During the start phase, the following functions are supported by default:

- Deragging mode for pumps for cleaning the pump system, improving efficiency and reducing wear
- Pipe filling mode for preventing pressure shocks in pipeline systems
- Two acceleration ramps for shorter start/stop times
- Flying restart of the running motor for fast hot restart
- Automatic restart function after power failure during short downtimes

##### Operating phase

During the operating phase, the following functions are supported by default:

- Continued run mode with autonomous reduction of output and pulse frequency
- PID controller for autonomous closed-loop control mode, operated according to analog input values
- Up to 16 variable-speed setpoints as fixed frequencies
- Speed monitoring via sensor (pulse input)
- Multi-pump control of up to four pumps
- Protection against blocking, leakage, dry running and cavitation
- Fire response mode for extended operation in case of emergency
- Skip frequencies for skipping critical frequencies and avoiding vibration
- Real time clock for switching over setpoints or controlling releases

##### Stop phase

During the stop phase, the following functions are supported by default:

- STO (Safe Torque Off) according to IEC 61508 SIL 3 and EN ISO 13489-1 PL e and Category 3. External components (e.g. safety relays) are necessary for using the STO safety function.
- ON/OFF2 for a optimized braking ramp
- Condensation protection for the motor
- Frost protection function for the pump

A detailed description of the functions and connection diagrams are included in the device documentation.

### *Commissioning of complex applications*

Sample applications, which include the description and device setting, are provided for SINAMICS G120X.

The following application descriptions are available:

- Fan for exhaust air with closed-loop control of pressure and air quality
- Fan for cooling tower with closed-loop control of the cooling water temperature
- Fan for tunnel/parking garage with closed-loop control of air quality and essential service mode
- Fan for supply air with closed-loop control of pressure, temperature, air quality and flowrate
- Pumps with closed-loop control of the pressure
- Pumps with closed-loop control of the filling level
- Pumps for cooling circuits with closed-loop control of the temperature
- Compressor with closed-loop control of the pressure
- Vacuum pump with closed-loop control of the pressure

Practical application examples and descriptions are available on the Internet at

[www.siemens.com/sinamics-applications](http://www.siemens.com/sinamics-applications)

# System overview

## SINAMICS G120X Starter Kits

1

### Overview

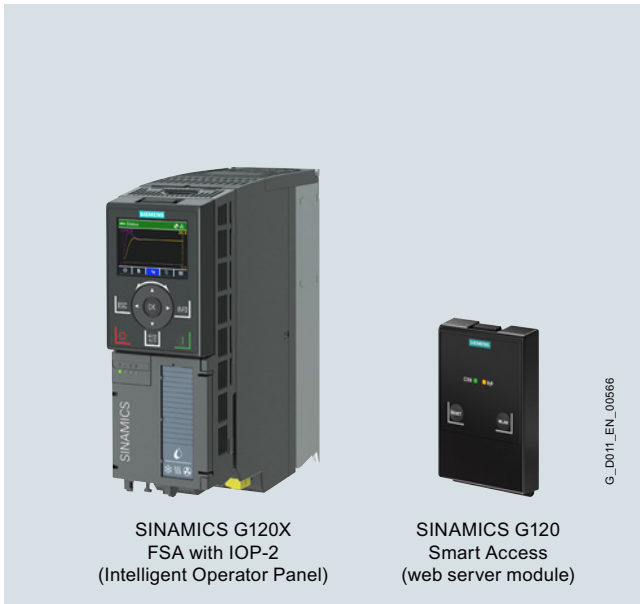

Example: SINAMICS G120X Starter Kit, frame size FSA, 0.75 kW, with IOP-2 Intelligent Operator Panel and SINAMICS G120 Smart Access

A SINAMICS G120X Starter Kit comprises a SINAMICS G120X converter (380 ... 480 V 3 AC; PROFINET) with an IOP-2 Intelligent Operator Panel and a SINAMICS G120 Smart Access web server module.

The delivery quantity is limited to three units per customer.

The SINAMICS G120X Starter Kits can be perfectly combined with the SIMATIC Starter Kits. In this way simple drive tasks up to motion control applications can be quickly implemented.

Further information on SIMATIC Starter Kits can be found at:

[www.siemens.com/s7-1200-starterkits](http://www.siemens.com/s7-1200-starterkits)  
[www.siemens.com/s7-1500-starterkits](http://www.siemens.com/s7-1500-starterkits)

### Selection and ordering data

Description	Article No.
<b>SINAMICS G120X Starter Kits</b> Converter (380 ... 480 V 3 AC, PROFINET) with IOP-2 and SINAMICS G120 Smart Access	
<ul style="list-style-type: none"> <li>• 0.75 kW, FSA, without integrated line filter</li> </ul>	<b>6SL3200-0AE70-0AA0</b>
<ul style="list-style-type: none"> <li>• 0.75 kW, FSA, with integrated line filter Category C2</li> </ul>	<b>6SL3200-0AE72-0AA0</b>
<ul style="list-style-type: none"> <li>• 3 kW, FSA, with integrated line filter Category C2</li> </ul>	<b>6SL3200-0AE73-0AA0</b>
<ul style="list-style-type: none"> <li>• 7.5 kW, FSB, with integrated line filter Category C2</li> </ul>	<b>6SL3200-0AE74-0AA0</b>

# SINAMICS G120X infrastructure converters for HVAC/Water/Wastewater

## 0.75 kW to 630 kW (1 hp to 700 hp)

2



<p><b>2/2</b></p> <p>2/2</p> <p>2/3</p> <p>2/4</p> <p>2/4</p> <p>2/5</p> <p>2/6</p> <p>2/8</p> <p>2/10</p> <p>2/10</p> <p>2/11</p> <p>2/13</p> <p>2/14</p> <p>2/15</p> <p>2/17</p> <p>2/18</p> <p>2/24</p> <p>2/28</p> <p>2/29</p>	<p><b>SINAMICS G120X infrastructure converters for HVAC/Water/Wastewater</b></p> <p>Overview</p> <p>Benefits</p> <p>Application</p> <p>Design</p> <p>Function</p> <p>Integration</p> <p>Configuration</p> <p>Selection and ordering data</p> <ul style="list-style-type: none"> <li>• SINAMICS G120X converters · Degree of protection IP20/UL Open Type · 380 ... 480 V 3 AC</li> <li>- Configuration with line-side components</li> <li>- Configuration with load-side power components</li> <li>• SINAMICS G120X converters · Degree of protection IP20/UL Open Type · 500 ... 690 V 3 AC</li> <li>- Configuration with line-side components</li> <li>- Configuration with load-side power components</li> </ul> <p>Technical specifications</p> <p>Characteristic curves</p> <p>Dimensional drawings</p> <p>More information</p>	<p><b>2/30</b></p> <p>2/30</p> <p>2/31</p> <p>2/34</p> <p>2/35</p> <p>2/36</p> <p>2/37</p> <p>2/37</p> <p>2/37</p> <p>2/37</p> <p>2/37</p> <p><b>2/38</b></p> <p>2/38</p> <p>2/38</p> <p>2/38</p> <p>2/38</p> <p>2/38</p> <p>2/38</p> <p>2/38</p> <p>2/39</p> <p>2/39</p> <p>2/39</p> <p>2/39</p> <p>2/40</p>	<p><b>Supplementary system components</b></p> <p>Operator Panels</p> <ul style="list-style-type: none"> <li>• IOP-2 Intelligent Operator Panel</li> <li>• BOP-2 Basic Operator Panel</li> </ul> <p>Memory cards</p> <p>SINAMICS G120 Smart Access</p> <p>Push-through mounting frames for frame sizes FSA to FSG</p> <p>IP21 top covers for frame sizes FSA to FSG</p> <p>Installation kit for line-side cable connection, left, for frame size FSH</p> <p><b>Spare parts</b></p> <p>FPI board for frame sizes FSH and FSJ</p> <p>PSB board for frame sizes FSH and FSJ</p> <p>Current transformers for frame sizes FSH and FSJ</p> <p>Spare parts kit for Control Unit</p> <p>Shield connection kit for Control Unit</p> <p>Shield connection kits for Power Module</p> <p>Mounting set for frame sizes FSD to FSG</p> <p>Terminal cover kits for frame sizes FSD to FSG</p> <p>Fan units</p>
--	--	---	--

Further information about SINAMICS G120X can be found on the Internet at [www.siemens.com/sinamics-g120x](http://www.siemens.com/sinamics-g120x)

## SINAMICS G120X infrastructure converters for HVAC/Water/Wastewater

0.75 kW to 630 kW (1 hp to 700 hp)

### SINAMICS G120X infrastructure converters for HVAC/Water/Wastewater

#### Overview



SINAMICS G120X, frame sizes FSA to FSJ, degree of protection IP20, with IOP-2 Intelligent Operator Panel

Easy handling, utmost reliability, superior efficiency and advanced digitalization - Siemens offers an answer to these trends with the SINAMICS G120X converter series. SINAMICS G120X is an innovative and user-friendly converter series that has been specifically developed for applications performed in infrastructure environments such as water/wastewater, but also for tasks in building automation. In this context, the converter supports, for example, pump, fan and compressor applications through numerous integrated functionalities and combines these in one device for the target sectors.

The SINAMICS G120X converter is an integrated and efficient drive solution for a wide range of tasks. The system allows convenient handling through optimized user interfaces: IOP-2 Intelligent Operator Panel with graphic color display and the optional web server module SINAMICS G120 Smart Access - a WLAN-based web server solution. Thus, the SINAMICS G120X fulfils the request for an easy and fast setup of the devices during the commissioning phase. Further, experienced users can use the full flexibility of a SINAMICS converter and adjust the relevant application to their requirements.

Totally integrated operation - this approach is also supported from ordering through to delivery.

For example, all the major features of the converter are configured and displayed in the article number. The delivery includes the complete device - as configured - that means, the converter and the selected operator panel.

In addition, SINAMICS G120X has an extremely rugged and reliable construction. The integrated DC link reactor with a maximum output of 250 kW and optional resistance to harmful gases up to environmental class 3C3 ensure a reliable, stable and largely robust operation.

The converter system is fit for digitalization. Thanks to its full integration in the SINAMICS CONNECT 300 system, data from up to eight converters can be acquired and transferred to the MindSphere cloud solution. The MindSphere application "Analyze MyDrives" facilitates the evaluation of data - tailored to individual customer needs. This simplifies the acquisition and evaluation of converter conditions.

Further, the SINAMICS G120X converter series provides innovative hardware and software functions, e.g. for controlling synchronous reluctance drive systems with SIMOTICS reluctance motors. In this way, the SINAMICS G120X converter series makes a substantial contribution towards saving energy and makes more careful use of our natural resources.

#### User-friendliness

A high degree of user-friendliness is one of the main characteristics of the SINAMICS G120X:

- Operator panel with color display and extensive diagnostics functions (IOP-2 Intelligent Operator Panel)
- Two different setup options are available: Standard and quick start with graphical user guidance
- Optimized setups for pumps and fans in the web server module SINAMICS G120 Smart Access
- SINAMICS SD card for storing parameter settings, cloning and local commissioning

#### Integrated functionalities for the start/operational/stop phases of the application

SINAMICS G120X is always preset, depending on the selected converter performance. Further, the following functions can be easily selected and parameterized:

##### Start phase

During the start phase, the following functions are supported by default:

- Deragging mode for pumps for cleaning the pump system, improving efficiency and reducing wear
- Pipe filling mode for preventing pressure shocks in pipeline systems
- Two acceleration ramps for shorter start/stop times
- Flying restart of the running motor for fast hot restart
- Automatic restart function after power failure during short downtimes

##### Operating phase

During the operating phase, the following functions are supported by default:

- Continued run mode with autonomous reduction of output and pulse frequency
- PID controller for autonomous closed-loop control mode, operated according to analog input values
- Up to 16 variable-speed setpoints as fixed frequencies
- Speed monitoring via sensor (pulse input)
- Multi-pump control of up to four pumps
- Protection against blocking, leakage, dry running and cavitation
- Fire response mode for extended operation in case of emergency
- Skip frequencies for skipping critical frequencies and avoiding vibration
- Real time clock for switching over setpoints or controlling releases

##### Stop phase

During the stop phase, the following functions are supported by default:

- STO (Safe Torque Off) according to IEC 61508 SIL 3 and EN ISO 13489-1 PL e and Category 3. External components (e.g. safety relays) are necessary for using the STO safety function.
- ON/OFF2 for a optimized braking ramp
- Condensation protection for the motor
- Frost protection function for the pump

A detailed description of the functions and connection diagrams are included in the device documentation.



# SINAMICS G120X infrastructure converters for HVAC/Water/Wastewater

0.75 kW to 630 kW (1 hp to 700 hp)

## SINAMICS G120X infrastructure converters for HVAC/Water/Wastewater

### Commissioning of complex applications

Sample applications, which include the description and device setting, are provided for SINAMICS G120X.

The following application descriptions are available:

- Fan for exhaust air with closed-loop control of pressure and air quality
- Fan for cooling tower with closed-loop control of the cooling water temperature
- Fan for tunnel/parking garage with closed-loop control of air quality and essential service mode
- Fan for supply air with closed-loop control of pressure, temperature, air quality and flowrate
- Pumps with closed-loop control of the pressure
- Pumps with closed-loop control of the filling level
- Pumps for cooling circuits with closed-loop control of the temperature
- Compressor with closed-loop control of the pressure
- Vacuum pump with closed-loop control of the pressure

Practical application examples and descriptions are available on the Internet at

[www.siemens.com/sinamics-applications](http://www.siemens.com/sinamics-applications)

### Benefits

#### Energy efficiency

SINAMICS G120X increases the efficiency and minimizes energy consumption in the complete process chain. The converter has integrated hardware as well as software functions as standard. The main features are:

- Power units with DC link reactor for extremely high active power component thanks to efficient converter topology - for the same drive power, the converter requires a lower line current than comparable converters
- Flux reduction through automatic adaptation of the motor current to the prevailing load conditions with closed-loop control modes V/f (ECO) and vector without sensor (SLVC) and savings of up to 5 % under partial load conditions
- Hibernation mode dependent on setpoints in the process
- High efficiency  $\eta \geq 98\%$

#### Application-specific commissioning and operation using operator panel

- Local commissioning without specialized knowledge of converters thanks to default settings and graphical user interface
- Unique: SINAMICS SD memory card for pre-parameterization and cloning of converter data sets
- Data backup for easy replacement
- Commissioning/diagnostics and controlling of converters

#### Flexible deployment of integrated functions

- Four integrated PID controllers  
Distributed closed-loop control for motor-independent process control without higher-level controller (PLC)
- Three freely programmable digital timer switches  
Control for freely selectable daily and weekly programs

### Flexible deployment across a wide range of applications

- Isolated digital inputs with separate potential group
- Isolated analog inputs
  - Potential transfer avoided
  - EMC-compliant design without the need for additional components in line with process industry requirements
- Direct connection of Pt1000/Ni1000 temperature sensors with optional SINAMICS G120X I/O Extension Module (available soon)
- 230 V AC relay
  - Direct control for auxiliary equipment, e.g. reactor or valve actuators
- Safety functions
  - Terminals for controlling the STO (Safe Torque Off) Safety function according to IEC 61508 SIL 3 and EN ISO 13489-1 PL e and Category 3.
  - External components (e.g. safety relays) are necessary for using the STO safety function.
  - For further information see the operating instructions [www.siemens.com/sinamics-g120x/documentation](http://www.siemens.com/sinamics-g120x/documentation)
- X9 terminal strip for devices in frame sizes FSH and FSJ (315 kW to 630 kW)
  - Input for external 24 V DC supply
  - Input for external alarm/fault
  - Input for EMERGENCY OFF/EMERGENCY STOP
  - Output for 24 V DC
  - Control of the main contactor
  - Feedback message "DC link charged"
- Use at ambient temperatures of -20 °C to +55 °C possible with PROFINET version (up to +60 °C with other versions available soon)
- Removable operator panel
  - Protection against unauthorized access
  - Color-coded signaling of operating states
- Replacement of individual components without the need for reinstallation
  - Plug-in version of control terminals (for replacement without removing wiring)
- Version for harsh environmental conditions
  - Coated modules for increased resistance to humidity and dust (Class 3C2)
  - PCB coating for environmental class/harmful chemical substances Class 3C3 acc. to EN 60721-3-3 (available soon)

### Extended warranty

#### Siemens offers for SINAMICS G120X an extended warranty up to 7½ years:

- 24 months of standard warranty
- Optional extension via **Drive Service Extended Exchange**
  - 6 months free of charge after product registration at: [www.siemens.com/drive-registration](http://www.siemens.com/drive-registration)
  - chargeable for additional 3 or 5 years

More information at:

<https://support.industry.siemens.com/cs/ww/en/sc/4842>

## SINAMICS G120X infrastructure converters for HVAC/Water/Wastewater

0.75 kW to 630 kW (1 hp to 700 hp)

### SINAMICS G120X infrastructure converters for HVAC/Water/Wastewater

#### Application

##### *The specialist for pump, fan and compressor applications*

SINAMICS G120X is ideally suited to pump applications (centrifugal pumps, oscillating and rotating pumps), fan applications (axial and radial fans) and compressor applications (cooling compressors, air and gas compressors). They are deployed in the water/waste water industries, in industrial environments, and in building automation.

SINAMICS G120X is ideally suited for the following applications:

- Circulating pumps for heating and cooling systems
- Pumps for pressure boosting stations
- Level control
- Fans in cooling towers
- Fans for air intake and discharge
- Fans for tunnels and multi-story car parks
- Fans for stairwells
- Compressors for cooling units

##### *Reliable operation in harsh environments*

SINAMICS G120X is suitable for use under harsh environmental conditions:

- Degree of protection IP20/UL Open Type for use in the control cabinet
- Degree of protection IP21 with optional IP21 top cover for use in lockable control rooms, including outside a control cabinet (available soon)
- Degree of protection IP20 with optional push-through mounting frame for space-saving design when installed in the control cabinet; power losses are dissipated using an external heat sink, separate internal air circulation (available soon)
- Use at ambient temperatures of -20 °C to +55 °C possible with PROFINET version (up to +60 °C with other versions available soon)
- Coated modules for increased resistance to humidity and dust (Class 3C2)
- Optional for environmental class/harmful chemical substances Class 3C3 acc. to EN 60721-3-3 (available soon)

#### Design

The converter is configured on the basis of the power requirement and the application. State-of-the-art IGBT technology with pulse-width modulation is used for reliable and flexible motor operation. Comprehensive protection functions provide a high degree of protection for the converter and motor.

The SINAMICS G120X converters in degree of protection IP20 are intended for installation in a control cabinet.

- Selection of the line filter for line voltage 380 V to 480 V 3 AC
  - Without integrated line filter, 0.75 kW to 132 kW
  - With integrated line filter Category C2, 0.75 kW to 250 kW
  - With integrated line filter Category C3, 160 kW to 560 kW
  - With additional line filter Category C1 for unfiltered devices, 0.75 kW to 110 kW (available soon)
  - With additional line filter Category C2 for filtered devices, 315 kW to 560 kW
- Selection of the line filter for line voltage 500 V to 690 V 3 AC
  - Without integrated line filter, 3 kW to 132 kW
  - With integrated line filter Category C2, 3 kW to 55 kW
  - With integrated line filter Category C3, 75 kW to 630 kW
  - With additional line filter Category C2 for filtered devices, 315 kW to 630 kW
- Environmental class/harmful chemical substances acc. to EN 60721-3-3
  - Class 3C2
  - Class 3C3 (available soon)
- Selection of communication
  - PROFINET, EtherNet/IP
  - PROFIBUS (available soon)
  - USS, Modbus RTU, BACnet MS/TP (available soon)
- Selection of the operator panel
 

The operator panels support user-friendly local commissioning, control and diagnostics and enable complete converter data sets to be pre-parameterized and cloned.

  - Without operator panel
  - BOP-2 Basic Operator Panel
 

The menu prompting and the 2-line display allow for simple commissioning of the converter. Simultaneous display of the parameter and parameter value, as well as parameter filtering, means that basic commissioning of a drive can also be performed without a printed parameter list.
  - IOP-2 Intelligent Operator Panel
 

Supports entry-level personnel as well as drive experts. Thanks to the color display, a user-friendly menu structure and wizards, it is much easier to commission, diagnose and locally control standard drives.

##### *Line-side power components*

The following line-side power components are available for the SINAMICS G120X converters:

- Line filters for categories C1, C2 and C3, see above
 

With an additional line filter, the converter complies with a higher radio interference class.
- Line reactors for devices from 315 kW and for frame sizes FSH and FSJ
 

Line reactors smooth the current drawn by the converter and thus reduce harmonic components in the line current. Through the reduction of the current harmonics, the thermal load on the power components in the rectifier and in the DC link capacitors is reduced as well as the harmonic effects on the supply. The use of a line reactor increases the service life of the converter.

SINAMICS G120X frame sizes FSA to FSG feature an integrated DC link reactor as standard. The use of an additional line reactor is not necessary for this.

# SINAMICS G120X infrastructure converters for HVAC/Water/Wastewater

0.75 kW to 630 kW (1 hp to 700 hp)

## SINAMICS G120X infrastructure converters for HVAC/Water/Wastewater

### Recommended line-side overcurrent protection devices and power components

This section contains recommendations for additional line-side components, such as Siemens fuses and circuit breakers (line-side components must be dimensioned in accordance with IEC standards).

Additional information about the listed fuses and circuit breakers is available in the Catalogs LV 10, IC 10 and IC 10 AO as well as in the Industry Mall.

### **Load-side power components**

Various load-side power components are available for the SINAMICS G120X converters. These allow the use of longer shielded motor cables and increase the motor service life:

- Sine-wave filters for frame sizes FSA to FSF (available soon)  
Sine-wave filters limit the rate of voltage rise (dv/dt) and the peak voltages on the motor winding. Similar to an output reactor, they enable the connection of longer motor cables.
- dv/dt filters plus VPL for frame sizes FSD to FSG  
dv/dt filters plus VPL (Voltage Peak Limiter) limit the voltage rate-of-rise dv/dt to values of <500 V/μs and the typical voltage peaks to values according to the limit value curve according to IEC/TS 60034-17: 2006.  
Standard motors with standard insulation and without insulated bearings can be used for converter operation if a dv/dt filter plus VPL is used.
- dv/dt filters compact plus VPL for frame sizes FSH and FSJ  
dv/dt filters compact plus VPL (Voltage Peak Limiter) limit the voltage rate-of-rise dv/dt to values of <1600 V/μs and the typical voltage peaks to values according to the limit value curve A to IEC 60034-25: 2007.  
Standard motors with standard insulation and without insulated bearings can be used for converter operation if a dv/dt filter compact plus VPL is used.

### **Optional accessories**

- SINAMICS memory card (SD card)
- SINAMICS G120 Smart Access for simple setup via Wi-Fi
- Push-through mounting frame for frame sizes FSA to FSG (available soon)
- Increase in degree of protection to IP21 with IP21 top covers for frame sizes FSA to FSG (available soon)
- Installation kit for line-side cable connection, left, for frame size FSH
- SINAMICS CONNECT 300 for connecting up to eight converters to the MindSphere cloud (available soon)

### Note:

Shield connection kits are an integral component of the delivery.

### **Spare parts**

- FPI (freely programmable interface) board for frame sizes FSH and FSJ (available soon)
- PSB (power supply board) board for frame sizes FSH and FSJ (available soon)
- Current transformers for frame sizes FSH and FSJ (available soon)
- Spare parts kit for Control Unit for frame sizes FSA and FSJ (available soon)
- Shield connection kit for Control Unit for frame sizes FSD to FSG (available soon)
- Shield connection kits for Power Module for frame sizes FSD to FSG (available soon for frame sizes FSA to FSC)
- Mounting set for frame sizes FSD to FSG
- Terminal cover kits for covering the connecting terminals for frame sizes FSD to FSG
- Fan units

- External for frame sizes FSD to FSJ (available soon for frame sizes FSA to FSC)
- Internal for frame sizes FSH and FSJ (available soon)

## Function

### **Technology function**

Functions specific to pumps, fans and compressors are already integrated, e.g.:

- Specific firmware functions such as deragging or pipe fill mode
- Automatic restart  
Application restart after a power failure or fault occurrence
- Flying restart  
Connection of the converter when the motor is running
- Flux reduction  
Automatic adaptation of the motor current to the prevailing load conditions in V/f control mode (ECO mode) as well as in sensorless vector control mode
- Cascade connection  
Load-dependent connection and disconnection of a maximum of three additional motors by the converter in order to provide a largely constant output power (implemented by means of an additional external circuit)
- Hibernation mode  
Startup or shutdown of the drive when the relevant value drops below an external setpoint or the internal PID controller setpoint
- Real-time clock  
For time-dependent process controls, e.g. to reduce the temperature of a heating control at night and with automatic daylight saving/standard time switchover

### Functions especially for building technology as well as heating/air conditioning/ventilation applications

- Four integrated PID controllers  
One PID controller for controlling the drive speed as a function of pressure, temperature, flowrate, fill level, air quality and other process variables; a further three PID controllers with freely configurable outputs, e.g. for controlling valves (heating, cooling) or flaps
- Emergency mode  
Special converter operating mode that enhances the availability of the drive system in the event of a fire
- Bypass mode  
When the setpoint is reached or a fault occurs, the system changes over to line operation (implemented by means of an additional external circuit)
- Programmable time switches

# SINAMICS G120X infrastructure converters for HVAC/Water/Wastewater

0.75 kW to 630 kW (1 hp to 700 hp)

## SINAMICS G120X infrastructure converters for HVAC/Water/Wastewater

### Integration

2

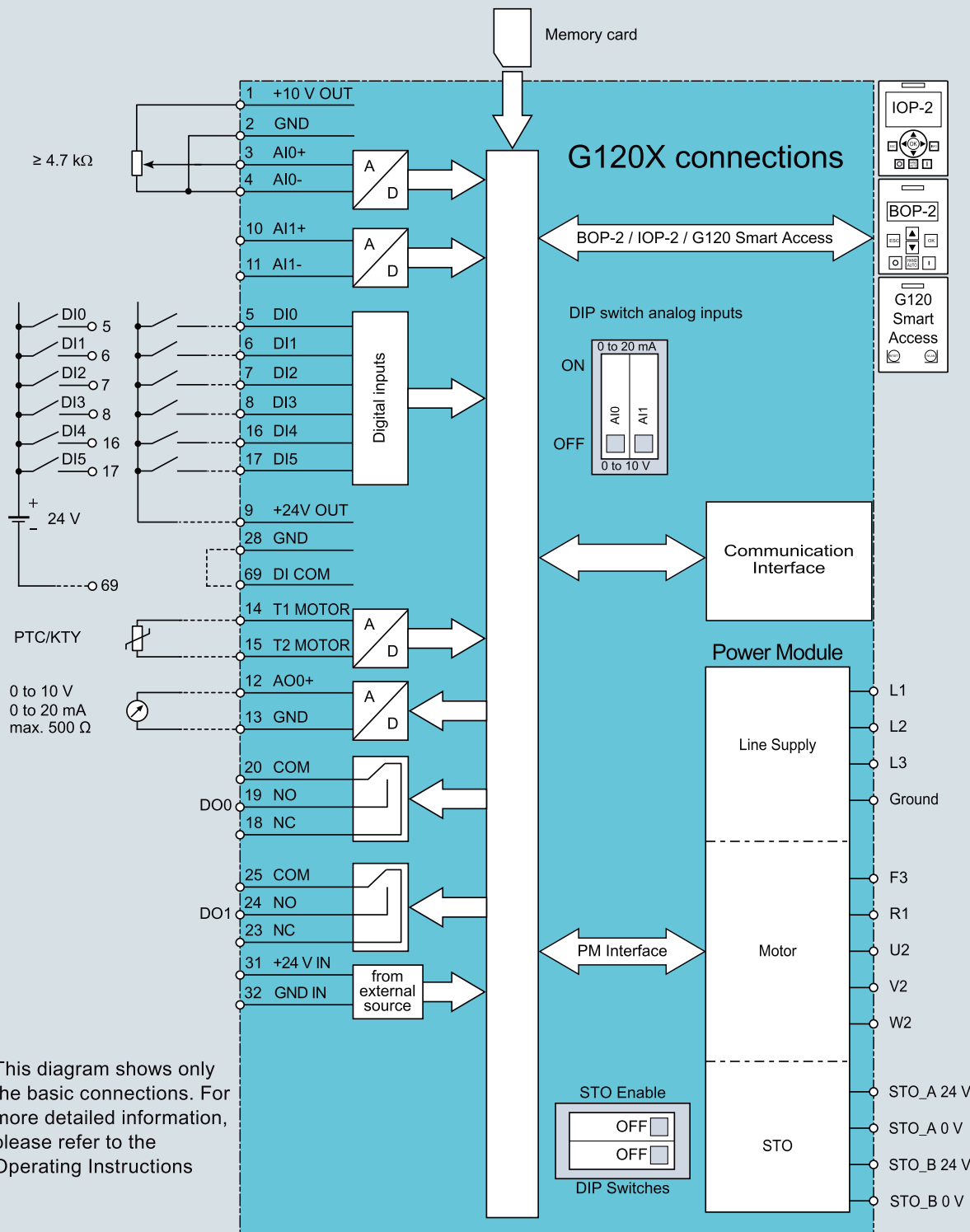

Block diagram SINAMICS G120X

# SINAMICS G120X infrastructure converters for HVAC/Water/Wastewater

0.75 kW to 630 kW (1 hp to 700 hp)

## SINAMICS G120X infrastructure converters for HVAC/Water/Wastewater

### Integration (continued)

#### CU Interfaces

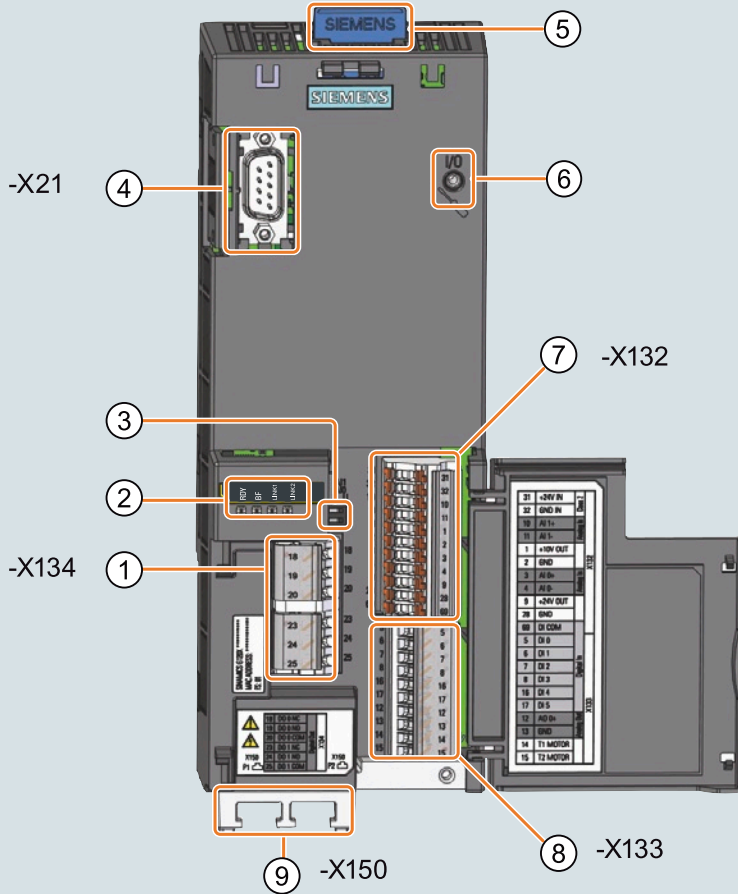

1	Terminal strip X134
2	Status LEDs
3	Analog Input selection DIP switch
4	Interface X21 for Operator Panel or SINAMICS G120 Smart Access
5	Memory card slot
6	Reserved for future use
7	Terminal strip X132
8	Terminal strip X133
9	PROFINET interface

#### PROFINET connections

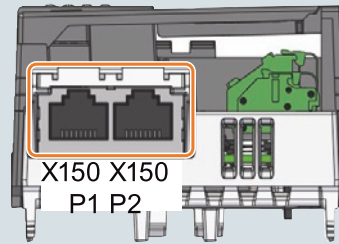

#### Terminal strips with wiring example

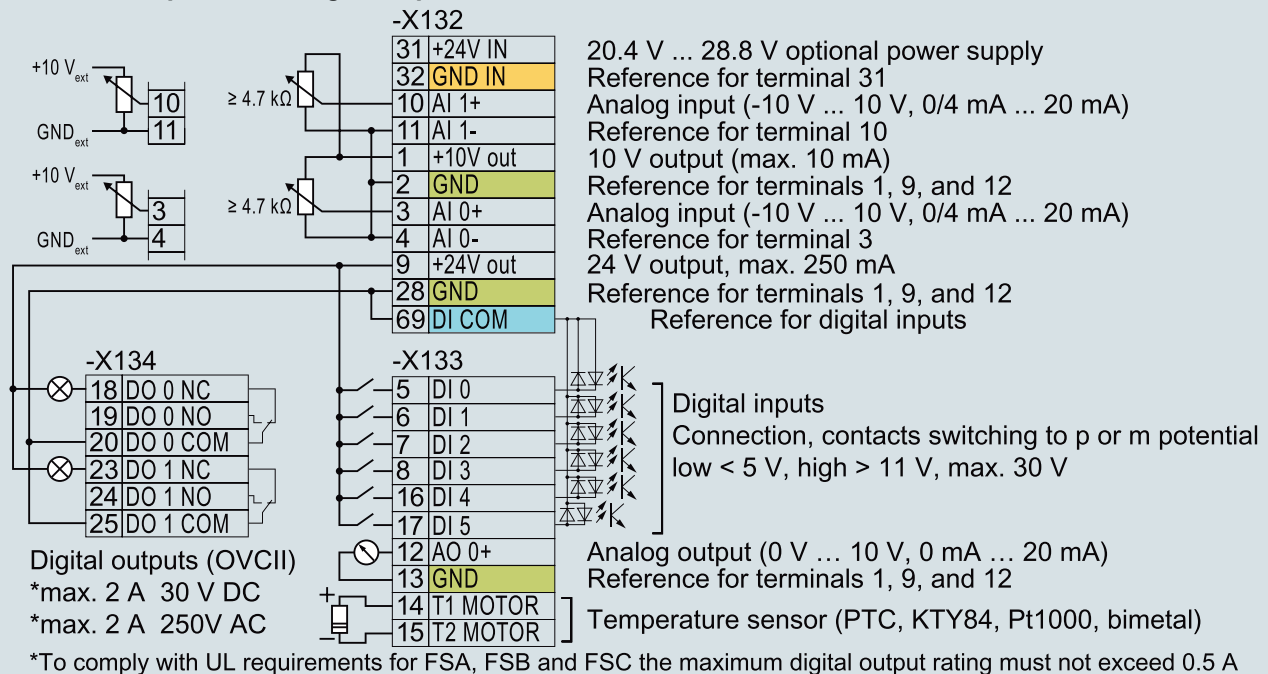

Connection example for SINAMICS G120X



## SINAMICS G120X infrastructure converters for HVAC/Water/Wastewater

0.75 kW to 630 kW (1 hp to 700 hp)

### SINAMICS G120X infrastructure converters for HVAC/Water/Wastewater

#### Configuration

The following electronic configuring guides and engineering tools are available for SINAMICS G120X converters:

##### **SINAMICS SELECTOR app (available soon)**

###### Mobile selection guide for frequency converters

Siemens has developed the SINAMICS SELECTOR app as a practical tool for finding article numbers for your SINAMICS converters in the power range from 0.12 kW to 630 kW quickly and easily. Whether for SINAMICS V20, SINAMICS G120C, SINAMICS G120X (available soon) or SINAMICS G120: The app will provide you with the correct article numbers conveniently.

How does it work? Simply select your application, the frequency converter you require, the rated power and device options as well as the necessary accessories.

Then you can save your selection and send it by email. Your pre-selection is the basis for an order specification with the dealer/Siemens.

You will find the free downloads for Android and for iOS at the following link:

[www.siemens.com/sinamics-selector](http://www.siemens.com/sinamics-selector)

##### **SINAMICS ASSISTANT app**

The error code function of the SINAMICS ASSISTANT app helps you to identify and rectify errors. Just enter the error code of your frequency converter and the app shows you what sort of error it is and how you can rectify it.

This app also recalculates for you the frequency (Hz) of a frequency converter into the speed to be set on the motor (rpm) or vice versa.

In addition, this app offers you a support page on which you can get in touch straight away with the right contact person in your region if you have any questions. Furthermore, video information is available to you free of charge, e.g. on installation and commissioning of the SINAMICS G120 frequency converter.

You will find the free downloads for Android and for iOS at the following link:

[www.siemens.com/sinamics-assistant](http://www.siemens.com/sinamics-assistant)

##### **Drive Technology Configurator (DT Configurator)**

###### Drive Technology Configurator (DT Configurator) within the CA 01

The interactive catalog CA 01 – the offline Industry Mall of Siemens – contains over 100000 products with approximately 5 million possible drive system product variants. The Drive Technology Configurator (DT Configurator) has been developed to facilitate selection of the correct motor and/or converter from the wide spectrum of drives. It is integrated as a selection tool in Catalog CA 01.

###### Online DT Configurator

In addition, the DT Configurator can be used on the Internet without requiring any installation. The DT Configurator can be found in the Siemens Industry Mall at the following address:

[www.siemens.com/dt-configurator](http://www.siemens.com/dt-configurator)

You can find further information on the Drive Technology Configurator (DT Configurator) in the Engineering tools section.

##### **TIA Selection Tool**

###### Selection tool and configurator for automation technology

Flawless configuration without expert knowledge through intelligent configurators and selection wizards. Desktop and cloud versions enable cross-team work with maximum flexibility.

There are two versions of the TIA Selection Tool:

- One for downloading and executing on Windows PCs (from Microsoft Windows 7)
- One for running from the cloud, which is launched from mobile devices directly in the browser (we recommend Safari, Chrome and Firefox)

Projects stored in the cloud can be edited with both tools. This makes it possible to work on-the-go using a tablet, at home on a PC – and vice versa, or together with colleagues and customers.

In order to use the full functionality, we recommended setting up a Siemens Industry Mall account for both cases. This gives you access to prices and enables you to save your projects to our cloud.

You can find more information on the TIA Selection Tool at [www.siemens.com/tia-selection-tool](http://www.siemens.com/tia-selection-tool)

##### **SIMARIS planning tools for plants with SINAMICS drives**

###### Electrical planning: Even easier with software!

Electrical planning for power distribution in non-residential and industrial buildings has never been more complex. To ensure you, as a specialist planner, have the best hand when it comes to electrical planning with SINAMICS drives, we provide support with the following efficient software tools: SIMARIS design for dimensioning and SIMARIS project for calculating the space requirements of the distribution boards.

You can find more information on the SIMARIS planning tools for plants with SINAMICS drives in the Engineering tools section.

##### **SinaSave energy efficiency tool**

###### Use SinaSave to calculate potential energy savings

The web-based tool SinaSave can be used to estimate the potential savings which can be achieved over the entire lifecycle, e.g. for pump and fan applications, thanks to SINAMICS. The tool takes into consideration all important plant-specific quantities, such as the power and load data of the application, the relevant control mode and the operation profile for the application in question. The result delivered by the tool specifies the potential energy savings which can be achieved with the specific application in conjunction with the Integrated Drive System or the drive component. The tool also provides a monetary evaluation of the potential savings and estimates the payback period.

You can find more information about the amortization calculator for energy-efficient drive systems at

[www.siemens.com/sinasave](http://www.siemens.com/sinasave)

You can find further information on the SinaSave energy efficiency tool in the Engineering tools section.

## SINAMICS G120X infrastructure converters for HVAC/Water/Wastewater 0.75 kW to 630 kW (1 hp to 700 hp)

### SINAMICS G120X infrastructure converters for HVAC/Water/Wastewater

#### **SIZER for Siemens Drives engineering tool**

The SIZER for Siemens Drives engineering tool makes it easy to configure the SINAMICS drive family. It provides support when selecting the hardware and firmware components necessary to implement a drive task. SIZER for Siemens Drives is designed to support configuring of the entire drive system.

The SIZER for Siemens Drives engineering tool is available free on the Internet at [www.siemens.com/sizer](http://www.siemens.com/sizer)

You can find further information on the SIZER for Siemens Drives engineering tool in the Engineering tools section.

#### **Drive ES PCS 7 engineering system (available soon)**

Drive ES PCS 7 integrates drives into the SIMATIC PCS 7 process control system. Drive ES PCS 7 provides a block library with blocks for the drives and the corresponding faceplates for the operator station.

More information about the Drive ES engineering system is available on the Internet at [www.siemens.com/drive-es](http://www.siemens.com/drive-es)

#### **SINAMICS web server for SINAMICS G120X via SINAMICS G120 Smart Access**

Web server for efficient commissioning, diagnostics and maintenance

The optionally available SINAMICS G120 Smart Access provides the SINAMICS G120X drive system with a web server for efficient commissioning, diagnostics and maintenance. The web server provides access to a multi-faceted range of new options for parameter assignment and drive diagnostics for laptops, tablets and smartphones.

You can find further information on the SINAMICS web server for SINAMICS G120X via SINAMICS G120 Smart Access in the Engineering tools section.

# SINAMICS G120X infrastructure converters for HVAC/Water/Wastewater

0.75 kW to 630 kW (1 hp to 700 hp)

[Clicking to the Industry Mall](#)

**6SL3255-0AA00-5AA0**



## SINAMICS G120X infrastructure converters for HVAC/Water/Wastewater

### Selection and ordering data

**SINAMICS G120X converters · Degree of protection IP20/UL Open Type · 380 ... 480 V 3 AC → Configuration with line-side components (see right page)**

Rated power <sup>1)</sup>		Base-load current $I_L$ <sup>2)</sup>		Rated input current <sup>3)</sup>	Frame size	SINAMICS G120X Degree of protection IP20/UL Open Type without integrated line filter	SINAMICS G120X Degree of protection IP20/UL Open Type with integrated line filter
400 V kW	480 V hp	400 V A	480 V A	400 V A		Converters up to 132 kW delivery ex stock	Converters up to 132 kW delivery ex stock
						10 ... 48 ↓↓	10 ... 48 ↓↓
						Article No.	Article No.

**380 ... 480 V 3 AC · Rated pulse frequency 4 kHz ≤ 90 kW and 2 kHz ≥ 110 kW · Input frequency 47 ... 63 Hz**

0.75	1	2.2	2.1	2.1	FSA	6SL32 0- YE10- U 0	6SL32 0- YE10- A 0
1.1	1.5	3.1	3	2.8	FSA	6SL32 0- YE12- U 0	6SL32 0- YE12- A 0
1.5	2	4.1	3.4	3.6	FSA	6SL32 0- YE14- U 0	6SL32 0- YE14- A 0
2.2	3	5.9	4.8	5.5	FSA	6SL32 0- YE16- U 0	6SL32 0- YE16- A 0
3	4	7.7	6.2	6.9	FSA	6SL32 0- YE18- U 0	6SL32 0- YE18- A 0
4	5	10.2	7.6	9.8	FSB	6SL32 0- YE20- U 0	6SL32 0- YE20- A 0
5.5	7.5	13.2	11	12	FSB	6SL32 0- YE22- U 0	6SL32 0- YE22- A 0
7.5	10	18	14	17	FSB	6SL32 0- YE24- U 0	6SL32 0- YE24- A 0
11	15	26	21	24.5	FSC	6SL32 0- YE26- U 0	6SL32 0- YE26- A 0
15	20	32	27	29.5	FSC	6SL32 0- YE28- U 0	6SL32 0- YE28- A 0
18.5	25	38	34	37	FSD	6SL32 0- YE30- U 0	6SL32 0- YE30- A 0
22	30	45	40	44	FSD	6SL32 0- YE32- U 0	6SL32 0- YE32- A 0
30	40	60	52	59	FSD	6SL32 0- YE34- U 0	6SL32 0- YE34- A 0
37	50	75	65	72	FSD	6SL32 0- YE36- U 0	6SL32 0- YE36- A 0
45	60	90	77	89	FSE	6SL32 0- YE38- U 0	6SL32 0- YE38- A 0
55	75	110	96	107	FSE	6SL32 0- YE40- U 0	6SL32 0- YE40- A 0
75	100	145	124	144	FSF	6SL32 0- YE42- U 0	6SL32 0- YE42- A 0
90	125	178	156	177	FSF	6SL32 0- YE44- U 0	6SL32 0- YE44- A 0
110	150	205	180	203	FSF	6SL32 0- YE46- U 0	6SL32 0- YE46- A 0
132	200	250	240	247	FSF	6SL32 0- YE48- U 0	6SL32 0- YE48- A 0
160	250	302	302	308	FSG	-	6SL32 0- YE50- A 0
200	300	370	361	374	FSG	-	6SL32 0- YE52- A 0
250	400	477	477	482	FSG	-	6SL32 0- YE54- A 0
315	400	570	477	597	FSH	-	6SL32 2 0- YE56- 0 C F 0
355	450	640	515	668	FSH	-	6SL32 2 0- YE58- 0 C F 0
400	500	720	590	750	FSH	-	6SL32 2 0- YE60- 0 C F 0
450	500	820	663	870	FSJ	-	6SL32 2 0- YE62- 0 C F 0
500	600	890	724	945	FSJ	-	6SL32 2 0- YE64- 0 C F 0
560	700	1000	830	1061	FSJ	-	6SL32 2 0- YE66- 0 C F 0

#### Article No. supplements

**Environmental class/harmful chemical substances** acc. to EN 60721-3-3

Class 3C2 – **delivery ex stock**

Class 3C3 \* (available soon)

#### Operator Panel

Without Operator Panel \*

With BOP-2 Basic Operator Panel (numeric 2-line display) \*

With IOP-2 Intelligent Operator Panel (graphic color display) – **delivery ex stock**

**Extension with SINAMICS G120X I/O Extension Module** (available soon)

Without extension – **delivery ex stock**

#### Line filter

Without integrated line filter – **delivery ex stock**

With integrated line filter Category C2 – **delivery ex stock**

With integrated line filter Category C3 \*

#### Communication

(variants for PROFIBUS DP or USS, Modbus RTU, BACnet MS/TP available soon)

PROFINET, EtherNet/IP – **delivery ex stock**

\* If you select one of these supplements, the delivery time for converters up to 132 kW will change from "delivery ex stock" to "standard delivery time".

<sup>1)</sup> Rated power based on the base-load current  $I_L$ . The base-load current  $I_L$  is based on the duty cycle for low overload (LO).

<sup>2)</sup> The base-load current  $I_L$  is based on the duty cycle for low overload (LO). These current values are valid for 400 V or 480 V and are specified on the rating plate of the converter.

<sup>3)</sup> The input current depends on the motor load and line impedance. The input currents apply for a load at rated power (based on  $I_L$ ) for a line impedance corresponding to  $u_k = 1\%$ . The current values are specified on the rating plate of the converter.



# SINAMICS G120X infrastructure converters for HVAC/Water/Wastewater

0.75 kW to 630 kW (1 hp to 700 hp)

6SL3255-0AA00-5AA0



## SINAMICS G120X infrastructure converters for HVAC/Water/Wastewater

Line-side components (Configuration with load-side power components see next double page)

Line filters Category C2	Category C1 For frame sizes FSD to FSF mandatory using a converter with integrated line filter	Line harmonics filters <sup>1)</sup>	Line reactors For frame sizes FSH and FSJ mandatory when using an external line filter Category C2	Recommended line-side overcurrent protection devices <sup>4)</sup>					
				Fuses IEC-compliant	Fuses UL/cUL-compliant Rated voltage 600 V AC <sup>5)</sup>	Current A	Article No.	Fuse type Class/Article No.	Current A
Article No.	Article No.		Article No.						
SINAMICS G120X available with integrated line filter Category C2	Available soon	–	A DC line reactor is integrated for frame sizes FSA to FSG – therefore no line reactor is required.	10	<b>3NA3803</b>	J	10		
		–		16	<b>3NA3805</b>	J	15		
		–		16	<b>3NA3805</b>	J	15		
		–		16	<b>3NA3805</b>	J	15		
		–		16	<b>3NA3805</b>	J	15		
		–		32	<b>3NA3812</b>	J	35		
		–		32	<b>3NA3812</b>	J	35		
		–		32	<b>3NA3812</b>	J	35		
		–		50	<b>3NA3820</b>	J	50		
		–		50	<b>3NA3820</b>	J	50		
		6SL3203-0BE23-8BA0		UAC:FN344019113E2FAJRX	63	<b>3NA3822</b>	J	60	
				UAC:FN344022115E2FAJRX	80	<b>3NA3824</b>	J	70	
		6SL3203-0BE27-5BA0		UAC:FN344030115E2FAJRX	100	<b>3NA3830</b>	J	90	
				UAC:FN344037115E2FAJRX	100	<b>3NA3830</b>	J	100	
		6SL3203-0BE31-1BA0		UAC:FN344045115E2FAJRX	125	<b>3NA3832</b>	J	125	
				UAC:FN344055115E2FAJRX	160	<b>3NA3836</b>	J	150	
		6SL3203-0BE31-8BA0		UAC:FN344075116E2FAJRX	200	<b>3NA3140</b>	J	200	
				UAC:FN344090116E2FAJRX	224	<b>3NA3142</b>	J	250	
				UAC:FN3440110118E2FAJRX	300	<b>3NA3250</b>	J	300	
		–		UAC:FN3440132118E2FAJXX <sup>2)</sup>	315	<b>3NA3252</b>	J	350	
		–		UAC:FN3440160118E2FAJXX <sup>2)</sup>	355	<b>3NA3254</b>	J	400	
		–		UAC:FN3440200118E2FAJXX <sup>2)</sup>	400	<b>3NA3260</b>	J	500	
		–		UAC:FN3440132118E2FAJXX <sup>(2x) <sup>2) 3)</sup></sup>	630	<b>3NA3372</b>	J	600	
	6SL3760-0MR00-0AA0	–		–	6SL3000-0CE36-3AA0	710	<b>3NE1437-2</b>		710
		–		–	6SL3000-0CE37-7AA0	800	<b>3NE1438-2</b>		800
–		–	–	850	<b>3NE1448-2</b>		850		
–		–	6SL3000-0CE38-7AA0	1000	<b>3NB3350-1KK26</b>		1000		
–		–	6SL3000-0CE41-0AA0	1100	<b>3NB3351-1KK26</b>		1100		
–	–	–	1250	<b>3NB3352-1KK26</b>		1250			



<sup>1)</sup> Voltage 380 V to 415 V, frequency 50 Hz.

<sup>2)</sup> For 160 kW, 200 kW and 250 kW, only operation in Vector Control is permitted. V/f must not be used.

<sup>3)</sup> 250 kW with parallel connection of 2x 132 kW.

<sup>4)</sup> Further information at <https://support.industry.siemens.com/cs/document/109762895>

<sup>5)</sup> The Short Circuit Current Rating (SCCR) according to UL for industrial control panel installations to NEC Article 409 or UL 508A/508C or UL 61800-5-1 is 100 kA for SINAMICS G120X.

# SINAMICS G120X infrastructure converters for HVAC/Water/Wastewater

0.75 kW to 630 kW (1 hp to 700 hp)

Clicking to the Industry Mall

6SL3255-0AA00-5AA0



## SINAMICS G120X infrastructure converters for HVAC/Water/Wastewater

### Selection and ordering data (continued)

SINAMICS G120X converters · Degree of protection IP20/UL Open Type · 380 ... 480 V 3 AC → Configuration with load-side power components (see right page)

Rated power <sup>1)</sup>	Base-load current $I_L$ <sup>2)</sup>		Rated input current <sup>3)</sup>	Frame size	SINAMICS G120X Degree of protection IP20/UL Open Type without integrated line filter		SINAMICS G120X Degree of protection IP20/UL Open Type with integrated line filter	
	400 V kW	480 V hp			400 V A	480 V A	Converters up to 132 kW delivery ex stock	
			400 V A		Article No.	10 ... 48 ↓↓	Article No.	10 ... 48 ↓↓

380 ... 480 V 3 AC · Rated pulse frequency 4 kHz ≤90 kW and 2 kHz ≥ 110 kW · Input frequency 47 ... 63 Hz

0.75	1	2.2	2.1	2.1	FSA	6SL32 0- YE10- U 0	6SL32 0- YE10- A 0
1.1	1.5	3.1	3	2.8	FSA	6SL32 0- YE12- U 0	6SL32 0- YE12- A 0
1.5	2	4.1	3.4	3.6	FSA	6SL32 0- YE14- U 0	6SL32 0- YE14- A 0
2.2	3	5.9	4.8	5.5	FSA	6SL32 0- YE16- U 0	6SL32 0- YE16- A 0
3	4	7.7	6.2	6.9	FSA	6SL32 0- YE18- U 0	6SL32 0- YE18- A 0
4	5	10.2	7.6	9.8	FSB	6SL32 0- YE20- U 0	6SL32 0- YE20- A 0
5.5	7.5	13.2	11	12	FSB	6SL32 0- YE22- U 0	6SL32 0- YE22- A 0
7.5	10	18	14	17	FSB	6SL32 0- YE24- U 0	6SL32 0- YE24- A 0
11	15	26	21	24.5	FSC	6SL32 0- YE26- U 0	6SL32 0- YE26- A 0
15	20	32	27	29.5	FSC	6SL32 0- YE28- U 0	6SL32 0- YE28- A 0
18.5	25	38	34	37	FSD	6SL32 0- YE30- U 0	6SL32 0- YE30- A 0
22	30	45	40	44	FSD	6SL32 0- YE32- U 0	6SL32 0- YE32- A 0
30	40	60	52	59	FSD	6SL32 0- YE34- U 0	6SL32 0- YE34- A 0
37	50	75	65	72	FSD	6SL32 0- YE36- U 0	6SL32 0- YE36- A 0
45	60	90	77	89	FSE	6SL32 0- YE38- U 0	6SL32 0- YE38- A 0
55	75	110	96	107	FSE	6SL32 0- YE40- U 0	6SL32 0- YE40- A 0
75	100	145	124	144	FSF	6SL32 0- YE42- U 0	6SL32 0- YE42- A 0
90	125	178	156	177	FSF	6SL32 0- YE44- U 0	6SL32 0- YE44- A 0
110	150	205	180	203	FSF	6SL32 0- YE46- U 0	6SL32 0- YE46- A 0
132	200	250	240	247	FSF	6SL32 0- YE48- U 0	6SL32 0- YE48- A 0
160	250	302	302	308	FSG	-	6SL32 0- YE50- A 0
200	300	370	361	374	FSG	-	6SL32 0- YE52- A 0
250	400	477	477	482	FSG	-	6SL32 0- YE54- A 0
315	400	570	477	597	FSH	-	6SL32 2 0- YE56- 0 C F 0
355	450	640	515	668	FSH	-	6SL32 2 0- YE58- 0 C F 0
400	500	720	590	750	FSH	-	6SL32 2 0- YE60- 0 C F 0
450	500	820	663	870	FSJ	-	6SL32 2 0- YE62- 0 C F 0
500	600	890	724	945	FSJ	-	6SL32 2 0- YE64- 0 C F 0
560	700	1000	830	1061	FSJ	-	6SL32 2 0- YE66- 0 C F 0

#### Article No. supplements

Environmental class/harmful chemical substances acc. to EN 60721-3-3

Class 3C2 – **delivery ex stock**

Class 3C3 \* (available soon)

#### Operator Panel

Without Operator Panel \*

With BOP-2 Basic Operator Panel (numeric 2-line display) \*

With IOP-2 Intelligent Operator Panel (graphic color display) – **delivery ex stock**

Extension with SINAMICS G120X I/O Extension Module (available soon)

Without extension – **delivery ex stock**

#### Line filter

Without integrated line filter – **delivery ex stock**

With integrated line filter Category C2 – **delivery ex stock**

With integrated line filter Category C3 \*

#### Communication

(variants for PROFIBUS DP or USS, Modbus RTU, BACnet MS/TP available soon)

PROFINET, EtherNet/IP – **delivery ex stock**

\* If you select one of these supplements, the delivery time for converters up to 132 kW will change from "delivery ex stock" to "standard delivery time".

1) Rated power based on the base-load current  $I_L$ . The base-load current  $I_L$  is based on the duty cycle for low overload (LO).  
 2) The base-load current  $I_L$  is based on the duty cycle for low overload (LO). These current values are valid for 400 V or 480 V and are specified on the rating plate of the converter.

3) The input current depends on the motor load and line impedance. The input currents apply for a load at rated power (based on  $I_L$ ) for a line impedance corresponding to  $u_k = 1\%$ . The current values are specified on the rating plate of the converter.



# SINAMICS G120X infrastructure converters for HVAC/Water/Wastewater

0.75 kW to 630 kW (1 hp to 700 hp)

[Clicking to the Industry Mall](#)

6SL3255-0AA00-5AA0



## SINAMICS G120X infrastructure converters for HVAC/Water/Wastewater

### Selection and ordering data (continued)

SINAMICS G120X converters · Degree of protection IP20/UL Open Type · 500 ... 690 V 3 AC ⇒ Configuration with line-side components (see right page)

Rated power <sup>1)</sup>		Base-load current $I_L$ <sup>2)</sup>		Rated input current <sup>3)</sup>	Frame size	SINAMICS G120X Degree of protection IP20/UL Open Type without integrated line filter	SINAMICS G120X Degree of protection IP20/UL Open Type with integrated line filter
690 V kW	600 V hp	690 V A	600 V A	690 V A		Article No.	Article No.
<b>500 ... 690 V 3 AC · Rated pulse frequency 2 kHz · Input frequency 47 ... 63 Hz</b>							
3	4	5	5	6	FSD	6SL32 0- YH18- U 0	6SL32 0- YH18- A 0
4	5	6.3	6.3	7	FSD	6SL32 0- YH20- U 0	6SL32 0- YH20- A 0
5.5	7.5	9	9	10	FSD	6SL32 0- YH22- U 0	6SL32 0- YH22- A 0
7.5	10	11	11	12	FSD	6SL32 0- YH24- U 0	6SL32 0- YH24- A 0
11	10	14	14	15	FSD	6SL32 0- YH26- U 0	6SL32 0- YH26- A 0
15	15	19	19	19	FSD	6SL32 0- YH28- U 0	6SL32 0- YH28- A 0
18.5	20	23	23	23	FSD	6SL32 0- YH30- U 0	6SL32 0- YH30- A 0
22	25	27	27	26	FSD	6SL32 0- YH32- U 0	6SL32 0- YH32- A 0
30	30	35	35	34	FSD	6SL32 0- YH34- U 0	6SL32 0- YH34- A 0
37	40	42	42	41	FSD	6SL32 0- YH36- U 0	6SL32 0- YH36- A 0
45	50	52	52	52	FSE	6SL32 0- YH38- U 0	6SL32 0- YH38- A 0
55	60	62	62	60	FSE	6SL32 0- YH40- U 0	6SL32 0- YH40- A 0
75	75	80	80	80	FSF	6SL32 0- YH42- U 0	6SL32 0- YH42- C 0
90	100	100	100	99	FSF	6SL32 0- YH44- U 0	6SL32 0- YH44- C 0
110	125	125	125	124	FSF	6SL32 0- YH46- U 0	6SL32 0- YH46- C 0
132	150	144	144	141	FSF	6SL32 0- YH48- U 0	6SL32 0- YH48- C 0
160	150	171	171	175	FSG <sup>4)</sup>	–	6SL32 0- YH50- C 0
200	200	208	208	210	FSG <sup>4)</sup>	–	6SL32 0- YH52- C 0
250	250	250	250	255	FSG <sup>4)</sup>	–	6SL32 0- YH54- C 0
315	350	330	345	383	FSH	–	6SL32 2 0- YH56- 0 C F 0
355	400	385	388	416	FSH	–	6SL32 2 0- YH58- 0 C F 0
400	450	420	432	471	FSH	–	6SL32 2 0- YH60- 0 C F 0
450	500	470	487	537	FSH	–	6SL32 2 0- YH62- 0 C F 0
500	500	520	546	596	FSJ	–	6SL32 2 0- YH64- 0 C F 0
560	600	580	610	679	FSJ	–	6SL32 2 0- YH66- 0 C F 0
630	700	650	679	753	FSJ	–	6SL32 2 0- YH68- 0 C F 0

#### Article No. supplements

**Environmental class/harmful chemical substances** acc. to EN 60721-3-3

Class 3C2

Class 3C3 (available soon)

#### Operator Panel

Without Operator Panel

With BOP-2 Basic Operator Panel (numeric 2-line display)

With IOP-2 Intelligent Operator Panel (graphic color display)

#### Extension with SINAMICS G120X I/O Extension Module (available soon)

Without extension

#### Line filter

Without integrated line filter

With integrated line filter Category C2

With integrated line filter Category C3

#### Communication

(variants for PROFIBUS DP or USS, Modbus RTU, BACnet MS/TP available soon)

PROFINET, EtherNet/IP

2	3	1	2	3	0	U	A	C	F	F
3	3	2	3	0	0					

<sup>1)</sup> Rated power based on the base-load current  $I_L$ . The base-load current  $I_L$  is based on the duty cycle for low overload (LO).  
<sup>2)</sup> The base-load current  $I_L$  is based on the duty cycle for low overload (LO). These current values are valid for 690 V or 600 V and are specified on the rating plate of the converter.

<sup>3)</sup> The input current depends on the motor load and line impedance. The input currents apply for a load at rated power (based on  $I_L$ ) for a line impedance corresponding to  $u_k = 1\%$ . The current values are specified on the rating plate of the converter.

<sup>4)</sup> The 690 V versions of frame size FSG are only available with an integrated line filter Category C3. To operate the converters also within TN systems with grounded outer conductor, you must remove the grounding screw.

Clicking to the Industry Mall

6SL3255-0AA00-5AA0



# SINAMICS G120X infrastructure converters for HVAC/Water/Wastewater

0.75 kW to 630 kW (1 hp to 700 hp)

## SINAMICS G120X infrastructure converters for HVAC/Water/Wastewater

**Line-side components** (Configuration with load-side power components see next double page)

Line filters Category C2	Category C1	Line reactors For frame sizes FSH and FSJ mandatory when using an external line filter Category C2	Recommended line-side overcurrent protection devices <sup>1)</sup>			
			Fuses IEC-compliant		Fuses UL/cUL-compliant Rated voltage 600 V AC <sup>2)</sup>	
Article No.	Article No.	Current A	Article No.	Fuse type Class/Article No.	Current A	
SINAMICS G120X available with integrated line filter Category C2	-	A DC link reactor is integrated for frame sizes FSA to FSG – therefore no line reactor is required.	20	<b>3NA3807-6</b>	J	20
	-		20	<b>3NA3807-6</b>	J	20
	-		20	<b>3NA3807-6</b>	J	20
	-		20	<b>3NA3807-6</b>	J	20
	-		20	<b>3NA3807-6</b>	J	20
	-		25	<b>3NA3810-6</b>	J	25
	-		32	<b>3NA3812-6</b>	J	30
	-		40	<b>3NA3817-6KJ</b>	J	35
	-		50	<b>3NA3820-6KJ</b>	J	50
	-		63	<b>3NA3822-6</b>	J	60
	-		80	<b>3NA3824-6</b>	J	80
	-		80	<b>3NA3824-6</b>	J	80
	-		100	<b>3NA3830-6</b>	J	110
	-		125	<b>3NA3132-6</b>	J	150
	-		160	<b>3NA3136-6</b>	J	150
	-		200	<b>3NA3140-6</b>	J	200
	-		250	<b>3NE1227-0</b>		250
	-		315	<b>3NE1230-0</b>		315
	-		355	<b>3NE1331-0</b>		355
<b>6SL3760-0MS00-0AA0</b>	-	<b>6SL3000-0CH34-8AA0</b>	450	<b>3NE1333-2</b>		450
	-		500	<b>3NE1334-2</b>		500
	-		560	<b>3NE1435-2</b>		560
	-	<b>6SL3000-0CH36-0AA0</b>	630	<b>3NE1436-2</b>		630
	-		710	<b>3NE1437-2</b>		710
	-	<b>6SL3000-0CH38-4AA0</b>	800	<b>3NE1438-2</b>		800
	-		850	<b>3NE1448-2</b>		850

<sup>1)</sup> Further information at <https://support.industry.siemens.com/cs/document/109762895>

<sup>2)</sup> The Short Circuit Current Rating (SCCR) according to UL for industrial control panel installations to NEC Article 409 or UL 508A/508C or UL 61800-5-1 is 100 kA for SINAMICS G120X.

# SINAMICS G120X infrastructure converters for HVAC/Water/Wastewater

0.75 kW to 630 kW (1 hp to 700 hp)

[Clicking to the Industry Mall](#)

6SL3255-0AA00-5AA0



## SINAMICS G120X infrastructure converters for HVAC/Water/Wastewater

### Selection and ordering data (continued)

SINAMICS G120X converters · Degree of protection IP20/UL Open Type · 500 ... 690 V 3 AC ⇒ Configuration with load-side power components (see right page)

Rated power <sup>1)</sup>		Base-load current $I_L$ <sup>2)</sup>		Rated input current <sup>3)</sup>	Frame size	SINAMICS G120X Degree of protection IP20/UL Open Type without integrated line filter	SINAMICS G120X Degree of protection IP20/UL Open Type with integrated line filter
690 V kW	600 V hp	690 V A	600 V A	690 V A		Article No.	Article No.
<b>500 ... 690 V 3 AC · Rated pulse frequency 2 kHz · Input frequency 47 ... 63 Hz</b>							
3	4	5	5	6	FSD	6SL32 0- YH18- U 0	6SL32 0- YH18- A 0
4	5	6.3	6.3	7	FSD	6SL32 0- YH20- U 0	6SL32 0- YH20- A 0
5.5	7.5	9	9	10	FSD	6SL32 0- YH22- U 0	6SL32 0- YH22- A 0
7.5	10	11	11	12	FSD	6SL32 0- YH24- U 0	6SL32 0- YH24- A 0
11	10	14	14	15	FSD	6SL32 0- YH26- U 0	6SL32 0- YH26- A 0
15	15	19	19	19	FSD	6SL32 0- YH28- U 0	6SL32 0- YH28- A 0
18.5	20	23	23	23	FSD	6SL32 0- YH30- U 0	6SL32 0- YH30- A 0
22	25	27	27	26	FSD	6SL32 0- YH32- U 0	6SL32 0- YH32- A 0
30	30	35	35	34	FSD	6SL32 0- YH34- U 0	6SL32 0- YH34- A 0
37	40	42	42	41	FSD	6SL32 0- YH36- U 0	6SL32 0- YH36- A 0
45	50	52	52	52	FSE	6SL32 0- YH38- U 0	6SL32 0- YH38- A 0
55	60	62	62	60	FSE	6SL32 0- YH40- U 0	6SL32 0- YH40- A 0
75	75	80	80	80	FSF	6SL32 0- YH42- U 0	6SL32 0- YH42- C 0
90	100	100	100	99	FSF	6SL32 0- YH44- U 0	6SL32 0- YH44- C 0
110	125	125	125	124	FSF	6SL32 0- YH46- U 0	6SL32 0- YH46- C 0
132	150	144	144	141	FSF	6SL32 0- YH48- U 0	6SL32 0- YH48- C 0
160	150	171	171	175	FSG <sup>4)</sup>	–	6SL32 0- YH50- C 0
200	200	208	208	210	FSG <sup>4)</sup>	–	6SL32 0- YH52- C 0
250	250	250	250	255	FSG <sup>4)</sup>	–	6SL32 0- YH54- C 0
315	350	330	345	383	FSH	–	6SL32 2 0- YH56- 0 C F 0
355	400	385	388	416	FSH	–	6SL32 2 0- YH58- 0 C F 0
400	450	420	432	471	FSH	–	6SL32 2 0- YH60- 0 C F 0
450	500	470	487	537	FSH	–	6SL32 2 0- YH62- 0 C F 0
500	500	520	546	596	FSJ	–	6SL32 2 0- YH64- 0 C F 0
560	600	580	610	679	FSJ	–	6SL32 2 0- YH66- 0 C F 0
630	700	650	679	753	FSJ	–	6SL32 2 0- YH68- 0 C F 0

#### Article No. supplements

**Environmental class/harmful chemical substances** acc. to EN 60721-3-3

Class 3C2

Class 3C3 (available soon)

#### Operator Panel

Without Operator Panel

With BOP-2 Basic Operator Panel (numeric 2-line display)

With IOP-2 Intelligent Operator Panel (graphic color display)

#### Extension with SINAMICS G120X I/O Extension Module (available soon)

Without extension

#### Line filter

Without integrated line filter

With integrated line filter Category C2

With integrated line filter Category C3

#### Communication

(variants for PROFIBUS DP or USS, Modbus RTU, BACnet MS/TP available soon)

PROFINET, EtherNet/IP

2	3	2	3
1	2	1	2
3	3	3	3
0	0	0	0
U			
		A	
		C	
F			F

<sup>1)</sup> Rated power based on the base-load current  $I_L$ . The base-load current  $I_L$  is based on the duty cycle for low overload (LO).

<sup>2)</sup> The base-load current  $I_L$  is based on the duty cycle for low overload (LO). These current values are valid for 690 V or 600 V and are specified on the rating plate of the converter.

<sup>3)</sup> The input current depends on the motor load and line impedance. The input currents apply for a load at rated power (based on  $I_L$ ) for a line impedance corresponding to  $u_k = 1\%$ . The current values are specified on the rating plate of the converter.

<sup>4)</sup> The 690 V versions of frame size FSG are only available with an integrated line filter Category C3. To operate the converters also within TN systems with grounded outer conductor, you must remove the grounding screw.

Clicking to the Industry Mall

6SL3255-0AA00-5AA0



## SINAMICS G120X infrastructure converters for HVAC/Water/Wastewater

0.75 kW to 630 kW (1 hp to 700 hp)

### SINAMICS G120X infrastructure converters for HVAC/Water/Wastewater

#### Load-side power components (Configuration with line-side components see double page before)

Output reactors	Sine-wave filters	dv/dt filters plus VPL	
Article No.	Article No.	Article No.	
JTA:TEU2532-0FP00-4EA0	-	JTA:TEF1203-0GB	
	-		
	-		
	-		
	-		
	-		
	-		
JTA:TEU9932-0FP00-4EA0	-	JTA:TEF1203-0HB	
	-		
	-		
JTA:TEU9932-0FS00-0EA0	-	JTA:TEF1203-0JB	
	-		
JTA:TEU9932-1FC00-1BA0	-	JTA:TEF1203-0KB	
	-		
JTA:TEU9932-0FV00-1BA0	-	JTA:TEF1203-0LB	
	-		
JTA:TEU4732-0FA00-0BA0	-	JTA:TEF1203-0MB	
	-		
	-		
6SL3000-2AH34-7AA0	-	6SL3000-2DH35-8AA0	
	-		
6SL3000-2AH35-8AA0	-		
6SL3000-2AH38-1AA0	-	6SL3000-2DH38-1AA0	
	-		
	-		
	-		

2

# SINAMICS G120X infrastructure converters for HVAC/Water/Wastewater

0.75 kW to 630 kW (1 hp to 700 hp)

## SINAMICS G120X infrastructure converters for HVAC/Water/Wastewater

### Technical specifications

Unless explicitly specified otherwise, the following technical specifications are valid for all SINAMICS G120X.

#### General technical specifications

##### Mechanical specifications

##### Shock and vibration load

<ul style="list-style-type: none"> <li>• Frame sizes FSA to FSG           <ul style="list-style-type: none"> <li>- Transport in transport packaging acc. to EN 61800-5-1 and EN 60068-2-6</li> <li>- Vibration during operation acc. to EN 60721-3-3: 1995</li> </ul> </li> <li>• Frame sizes FSH and FSJ           <ul style="list-style-type: none"> <li>- Vibration in transport packaging: Test Fc acc. to EN 60068-2-64</li> <li>- Shock in product packaging: Test Fc acc. to EN 60068-2-6</li> <li>- Vibration during operation: Test Fc acc. to EN 60068-2-6</li> <li>- Shock during operation: Test acc. to EN 60068-2-27</li> </ul> </li> </ul>	Class 2M3  Class 3M1  $\pm 1.5$ mm for 5 ... 9 Hz $0.5 \times g$ at 9 ... 200 Hz $\pm 1.5$ mm for 5 ... 9 Hz $0.5 \times g$ at 9 ... 200 Hz 0.075 mm at 10 ... 58 Hz $9.81 \text{ m/s}^2 (1 \times g)$ at > 58 ... 200 Hz Shock type EA $49 \text{ m/s}^2 (5 \times g)/30 \text{ ms}$ $147 \text{ m/s}^2 (15 \times g)/11 \text{ ms}$
---	---

##### Degree of protection

<ul style="list-style-type: none"> <li>• Frame sizes FSA ... FSJ</li> <li>• Frame sizes FSA ... FSG</li> </ul>	IP20/ UL Open Type Optional IP21/ UL Open Type with IP21 top covers (available soon)
--	---

##### Permissible mounting position

Vertical wall mounting

##### Ambient conditions

##### Protection class

According to EN 61800-5-1

Class III (PELV1) for Power Module  
 Class II (PELV1) for Control Unit

##### Touch protection

According to EN 61800-5-1

Class I (with protective conductor system)

##### Humidity, max.

<95 % at 40 °C (104 °F), condensation and icing not permissible

##### Ambient temperature

<ul style="list-style-type: none"> <li>• Storage acc. to EN 60068-2-1           <ul style="list-style-type: none"> <li>- Frame sizes FSA to FSG</li> <li>- Frame sizes FSH and FSJ</li> </ul> </li> <li>• Transport acc. to EN 60068-2-1</li> <li>• Operation acc. to EN 60068-2-2           <ul style="list-style-type: none"> <li>- Frame sizes FSA to FSG</li> <li>- Frame sizes FSH and FSJ</li> <li>- All frame sizes with operator panel</li> </ul> </li> </ul>	-40 ... +70 °C (-40 ... +158 °F) -25 ... +55 °C (-13 ... +131 °F) -40 ... +70 °C (-40 ... +158 °F) -20 °C ... +55 °C (-4 ... +131 °F) with a side clearance of 5 cm or -20 °C ... +50 °C (-4 ... +122 °F) for side-by-side mounting, >45 °C (95 °F) with derating 0 ... 55 °C (32 ... 131 °F) with derating Current derating as a function of the ambient temperature 0 ... 50 °C (32 ... 122 °F) <a href="#">see also derating characteristics</a>
---	---

##### Environmental class in operation

<ul style="list-style-type: none"> <li>• Harmful chemical substances           <ul style="list-style-type: none"> <li>- Frame sizes FSA to FSG</li> <li>- Frame sizes FSH and FSJ</li> </ul> </li> <li>• Organic/biological pollutants</li> <li>• Degree of pollution</li> </ul>	Class 3C2 acc. to EN 60721-3-3 Optional: Class 3C3 acc. to EN 60721-3-3 (available soon) without operator panel Class 3C2 acc. to EN 60721-3-3 Class 3B1 acc. to EN 60721-3-3 2 acc. to EN 61800
--	--



# SINAMICS G120X infrastructure converters for HVAC/Water/Wastewater

0.75 kW to 630 kW (1 hp to 700 hp)

## SINAMICS G120X infrastructure converters for HVAC/Water/Wastewater

### Technical specifications (continued)

#### General technical specifications (continued)

##### Standards

##### Compliance with standards <sup>1)</sup>

- |                           |  |
|---------------------------|--|
| • Frame sizes FSA to FSG  | CE, UL, cUL, RCM, SEMI F47, RoHS II, EAC, KCC, REACH |
| • Frame sizes FSH and FSJ | CE, UL, cUL, RCM, SEMI F47, RoHS II, EAC, REACH      |

##### Fail-safe certification

- |                                 |   |
|---------------------------------|---|
| Function: Safe Torque Off (STO) | External components (e.g. safety relays) are necessary for using the STO safety function. |
| • According to IEC 61508        | SIL 3   |
| • According to EN ISO 13849-1   | PL d and Category 3   |

##### CE marking, according to

EMC Directive 2014/30/EU
Low Voltage Directive 2014/35/EU

##### EMC Directive <sup>1)</sup>

acc. to EN 61800-3

- |   |   |
|---|---|
| • Interference immunity   | The SINAMICS G120X converters are tested according to the interference immunity requirements for environments according to Category C3. |
| • Interference emissions  |   |
| - Frame sizes FSA to FSF without integrated line filter   | 2)  |
| - Frame sizes FSA to FSG with integrated line filter Category C2                                      | Observance of the limit values according to Category C2   |
| - Frame sizes FSG to FSJ with integrated line filter Category C3                                      | Observance of the limit values according to Category C3   |
| - Frame sizes FSH and FSJ with integrated line filter Category C3 and optional line reactor           | Observance of the limit values according to Category C2   |
| - Frame sizes FSA to FSC without integrated line filter with optional line filter Category C1         | Observance of the limit values according to Category C1   |
| - Frame sizes FSD to FSF with integrated line filter Category C2 and optional line filter Category C1 | Observance of the limit values according to Category C1   |

##### Note:

The EMC product standard EN 61800-3 does not apply directly to a frequency converter but to a PDS (Power Drive System), which comprises the complete circuitry, motor and cables in addition to the converter. The frequency converters on their own do not generally require identification according to the EMC Directive.

<sup>1)</sup> Additional information is available in the operating instructions on the Internet at: [www.siemens.com/sinamics-g120x/documentation](http://www.siemens.com/sinamics-g120x/documentation)

<sup>2)</sup> Non-filtered devices are designed for operation in IT systems or in conjunction with an RCD. The customer must provide suitable RI suppression equipment to ensure that these devices comply with the limits defined for Category C3.

## SINAMICS G120X infrastructure converters for HVAC/Water/Wastewater

0.75 kW to 630 kW (1 hp to 700 hp)

### SINAMICS G120X infrastructure converters for HVAC/Water/Wastewater

#### Technical specifications (continued)

##### SINAMICS G120X converters

##### Integrated bus interface

<b>Fieldbus protocols</b>	<ul style="list-style-type: none"> <li>• PROFINET</li> <li>• EtherNet/IP</li> </ul>
<b>Hardware</b>	2 × RJ45, max. 100 Mbit/s (full duplex), device name can be stored on the device
<b>I/O interfaces</b>	
<b>Signal cable cross-section</b>	0.15 ... 1.5 mm <sup>2</sup> (28 ... 16 AWG)
<b>Digital inputs – standard</b>	6 isolated inputs Optically isolated; Free reference potential (own potential group) NPN/PNP logic can be selected using the wiring
<ul style="list-style-type: none"> <li>• Switching level: 0 →1</li> <li>• Switching level: 1 →0</li> </ul>	11 V 5 V
<b>Digital inputs – fail-safe</b>	1 isolated input Max. input voltage 60 V Safety function: Safe Torque Off (STO) External components (e.g. safety relays) are necessary for using the STO safety function.
<b>Digital outputs</b>	2 relay changeover contacts 250 V AC, 2 A (inductive load), 30 V DC, 5 A (ohmic load)
<b>Analog inputs</b>	2 analog inputs Differential input Switchable between voltage (-10 ... +10 V) and current (0/4 ... 20 mA) using a DIP switch 12-bit resolution Can be used as additional digital input
<ul style="list-style-type: none"> <li>• Switching threshold: 0 →1</li> <li>• Switching threshold: 1 →0</li> </ul>	4 V 1.6 V
<b>Analog outputs</b>	1 non-isolated output Switchable between voltage (0 ... 10 V) and current (0/4 ... 20 mA) using a parameter Voltage mode: 10 V, min. burden 10 kΩ Current mode: 20 mA, max. burden 500 Ω The analog outputs have short-circuit protection
<b>PTC/KTY interface</b>	1 motor temperature sensor input Connectable sensors PTC, Pt1000, KTY and bimetal, accuracy ±5 °C
<b>Voltage supply for the integrated Control Unit</b>	24 V DC via the Power Module or by connecting to an external 20.4 ... 28.8 V DC power supply Typical input current: 500 mA at 24 V DC
<b>Tool interfaces</b>	
<b>Memory card</b>	Optional SINAMICS SD card
<b>Operator panels</b>	Optional BOP-2 Basic Operator Panel or IOP-2 Intelligent Operator Panel or SINAMICS G120 Smart Access

# SINAMICS G120X infrastructure converters for HVAC/Water/Wastewater

0.75 kW to 630 kW (1 hp to 700 hp)

## SINAMICS G120X infrastructure converters for HVAC/Water/Wastewater

### Technical specifications (continued)

#### SINAMICS G120X converters

##### Open-loop/closed-loop control techniques

V/f linear/quadratic/parameterizable	✓
V/f with flux current control (FCC)	✓
V/f ECO linear/quadratic	✓
Vector control, sensorless	✓

##### Software functions

Setpoint input, can be parameterized	✓
Fixed frequencies	16, parameterizable
JOG	✓
Digital motorized potentiometer (MOP)	✓
Ramp smoothing	✓
Extended ramp-function generator (with ramp smoothing OFF3)	✓
Slip compensation	✓
Switchable drive data sets (DDS)	✓ (4)
Switchable command data sets (CDS)	✓ (2)
Flying restart	✓
Automatic restart after line supply failure or operating fault (AR)	✓
Technology controller (internal PID)	✓
Energy saving display	✓
3 additional, free PID controllers	✓
2-zone controller	✓
Hibernation mode with internal/external PID controller	✓
Belt monitoring with and without sensor (load torque monitoring)	✓
Dry-running/overload protection monitoring (load torque monitoring)	✓
Deragging	✓
Thermal motor protection	✓ ( $R_t$ , sensor: PTC, Pt1000, KTY and bimetal)
Thermal converter protection	✓
Motor identification	✓
Auto-ramping ( $V_{dc\_max}$ controller)	✓
Kinetic buffering ( $V_{dc\_min}$ controller)	✓
<b>Braking functions</b>	
• DC braking	✓
• Compound braking	✓

# SINAMICS G120X infrastructure converters for HVAC/Water/Wastewater

0.75 kW to 630 kW (1 hp to 700 hp)

## SINAMICS G120X infrastructure converters for HVAC/Water/Wastewater

### Technical specifications (continued)

#### General technical specifications of the power electronics

##### System operating voltage

- Frame sizes FSA to FSG  
For systems complying with IEC:  
380 ... 480 V 3 AC +10 % -20 %  
500 ... 690 V 3 AC +10 % -20 %  
For systems complying with UL:  
380 ... 480 V 3 AC  
500 ... 600 V 3 AC
- Frame sizes FSH and FSJ  
380 ... 480 V 3 AC +10 % -15 %  
500 ... 690 V 3 AC +10 % -15 %

##### Line supply requirements Line impedance $u_K$

- Frame sizes FSA to FSG  
4 %
- Frame sizes FSH and FSJ  
A line reactor ( $u_K = 2 %$ ) must be connected in series, if the short-circuit power ratio  $R_{SC} > 33$  (315 ... 500 kW) or  $R_{SC} > 20$  (560 kW)

##### Input frequency

47 ... 63 Hz

##### Output frequency

- Frame sizes FSA to FSG  
Control mode V/f: 0 ... 550 Hz  
Control mode Vector: 0 ... 240 Hz
- Frame sizes FSH and FSJ  
Control mode V/f: 0 ... 150 Hz  
Control mode Vector: 0 ... 150 Hz

##### Pulse frequency

- Frame sizes FSA to FSG  
400 V:  
4 kHz for converters with a rated power  $\leq 90$  kW  
2 kHz for converters with a rated power  $\geq 110$  kW  
Higher pulse frequencies up to 16 kHz [see derating data](#)  
690 V:  
2 kHz  
Higher pulse frequencies up to 4 kHz [see derating data](#)
- Frame sizes FSH and FSJ  
2 kHz  
Self-adjusting up to 4 kHz [see derating data](#)

##### Power factor $\lambda$

- Frame sizes FSA to FSG  
0.75 ... 0.93
- Frame sizes FSH and FSJ  
0.75 ... 0.93 (with line reactor  $u_K = 2 %$ )

##### Offset factor $\cos \varphi$

- Frame sizes FSA to FSG  
0.96
- Frame sizes FSD to FSG  
0.99
- Frame sizes FSH and FSJ  
0.96

##### Output voltage, max. as % of line voltage

97 %

##### Overload capability

- Low overload (LO)  
1.1 × base-load current  $I_L$  (i. e. 110 % overload) for 60 s within a cycle time of 300 s
- High overload (HO)  
1.5 × base-load current  $I_H$  (i. e. 150 % overload) for 60 s within a cycle time of 600 s

##### Cooling

Air cooling using an integrated fan

##### Installation altitude

Up to 1000 m (3281 ft) above sea level without derating,  
>1000 m (3281 ft) [see derating characteristics](#)

##### Short Circuit Current Rating (SCCR) max.

100 kA [see Recommended line-side overcurrent protection devices](#) – the value depends on the fuses and circuit breakers used  
For more information, see:  
<https://support.industry.siemens.com/cs/document/109762895>

##### Protection functions

- Undervoltage
- Overvoltage
- Overcurrent/overload
- Ground fault
- Short-circuit
- Stall protection
- Motor blocking protection
- Motor overtemperature
- Converter overtemperature
- Parameter locking

# SINAMICS G120X infrastructure converters for HVAC/Water/Wastewater

0.75 kW to 630 kW (1 hp to 700 hp)

## SINAMICS G120X infrastructure converters for HVAC/Water/Wastewater

### Technical specifications (continued)

#### Maximum permissible motor cable lengths SINAMICS G120X

The values specified in the table below apply with low-capacitance CY cables and with pulse frequencies set in the factory.

	Maximum permissible motor cable lengths (shielded/unshielded) in m (ft)			
	FSA to FSC	FSD and FSE	FSF and FSG	FSH and FSJ
<b>Without compliance to the EMC category</b>				
<b>Converters without optional power components</b>				
• 400 V versions	150/300 (492/984)	200/300 (656/984)	300/450 (984/1476)	150/200 (492/656)
• 690 V versions	–	200/300 (656/984)	300/450 (984/1476)	150/200 (492/656)
<b>Converters with optional output reactor</b>				
• 400 V versions	–	200/300 (656/984) <sup>1)</sup>	300/450 (984/1476) <sup>1)</sup>	300/450 (984/1476)
• 690 V versions	–	200/300 (656/984) <sup>1)</sup>	300/450 (984/1476) <sup>1)</sup>	300/450 (984/1476)
<b>Converters with optional sine-wave filter</b>				
• 400 V versions	Available soon	200/300 (656/984)	FSF up to 90 kW: 200/300 (656/984) FSF 110 kW and higher and FSG: 300/450 (984/1476)	–
• 690 V versions	–	–	–	–
<b>Converters with optional dv/dt filter plus VPL</b>				
• 400 V versions	–	FSD up to 30 kW: 350/525 (1148/1723) FSD 37 kW and FSE: 450/650 (1476/2133) <sup>2)</sup>	450/650 (1476/2133) <sup>2)</sup>	300/450 (984/1476)
• 690 V versions	–	350/525 (1148/1723)	450/650 (1476/2133) <sup>2)</sup>	300/450 (984/1476)
<b>With compliance to the EMC category <sup>3)</sup></b>				
<b>Converters with integrated line filter</b>				
According to EN 61800-3 EMC Category C3				
• 400 V versions	150/– (492/–)	150/– (492/–)	150/– (492/–)	150/– (492/–) <sup>4)</sup>
• 690 V versions	–	100/– (328/–)	150/– (492/–)	150/– (492/–) <sup>4)</sup>
<b>Converters with integrated line filter</b>				
According to EN 61800-3 EMC Category C2				
• 400 V versions	150/– (492/–)	150/– (492/–)	150/– (492/–)	150/– (492/–)
• 690 V versions	–	100/– (328/–)	–	150/– (492/–) <sup>5)</sup>
<b>Converters with integrated line filter with external line filter Category C1</b>				
According to EN 55011 to comply with cable-conducted radio interference emissions according to EN 61800-3 EMC Category C1				
• 400 V versions	–	FSD: 10/– (32.8/–) FSE: 20/– (65.6/–)	FSF up to 110 kW: 10/– (32.8/–)	–
• 690 V versions	–	–	–	–
<b>Converters without integrated line filter with external line filter Category C1</b>				
To comply with cable-conducted radio interference emissions according to EN 61800-3 EMC Category C1				
• 400 V versions	Available soon	–	–	–
• 690 V versions	–	–	–	–

<sup>1)</sup> For frame sizes FSD to FSG the maximum permissible cable lengths are not increased with an output reactor. By means of the output reactor, the loading of the motor windings is reduced by lower rates of voltage rise ( $dv/dt$ ). By means of two output reactors connected in series, the maximum permissible cable lengths for frame sizes FSD and FSE are increased to 350 m (1148 ft) (shielded) and 525 m (1723 ft) (unshielded), and for frame sizes FSF and FSG to 525 m (1723 ft) (shielded) and 800 m (2625 ft) (unshielded).

<sup>2)</sup> Maximum overvoltage at the motor terminals < 1350 V with cable lengths up to 450 m (1476 ft) shielded or 650 m (2133 ft) unshielded – maximum overvoltage at the motor terminals < 1500 V with cable lengths up to 525 m (1723 ft) shielded or 800 m (2625 ft) unshielded.

<sup>3)</sup> Further information is available on the Internet at:  
[www.siemens.com/sinamics-g120x/documentation](http://www.siemens.com/sinamics-g120x/documentation)

<sup>4)</sup> For motor cable lengths of 100 m (328 ft) up to 150 m (492 ft) with an additional basic interference suppression module (available on request).

<sup>5)</sup> Use in the first environment, Category C2 only with external line filter Category C2 and line reactor.

## SINAMICS G120X infrastructure converters for HVAC/Water/Wastewater

0.75 kW to 630 kW (1 hp to 700 hp)

### SINAMICS G120X infrastructure converters for HVAC/Water/Wastewater

#### Characteristic curves

##### Derating data

##### Pulse frequency

Frame size	Rated power <sup>1)</sup> at 50 Hz 400 V 3 AC		Rated output current <sup>2)</sup> in A (at an ambient temperature of 45 °C (113 °F)) for a pulse frequency of							
	kW	hp	2 kHz	4 kHz	6 kHz	8 kHz	10 kHz	12 kHz	14 kHz	16 kHz
FSA	0.75	1	2.2	<b>2.2</b>	1.87	1.54	1.32	1.1	0.99	0.88
	1.1	1.5	3.1	<b>3.1</b>	2.635	2.17	1.86	1.55	1.395	1.24
	1.5	2	4.1	<b>4.1</b>	3.485	2.87	2.46	2.05	1.895	1.64
	2.2	3	5.9	<b>5.9</b>	5.015	4.13	3.54	2.95	2.655	2.36
	3	4	7.7	<b>7.7</b>	6.545	5.39	4.62	3.85	3.465	3.08
FSB	4	5	10.2	<b>10.2</b>	8.67	7.14	6.12	5.1	4.59	4.08
	5.5	7.5	13.2	<b>13.2</b>	11.22	9.24	7.92	6.6	5.94	5.28
	7.5	10	18	<b>18</b>	15.3	12.6	10.8	9	8.1	7.2
FSC	11	15	26	<b>26</b>	22.1	18.2	15.6	13	11.7	10.4
	15	20	32	<b>32</b>	27.2	22.4	19	18	14.4	12.8
FSD	18.5	25	38	<b>38</b>	32.3	26.6	22.8	19	17.1	15.2
	22	30	45	<b>45</b>	38.2	31.5	27	22.5	20.2	18
	30	40	60	<b>60</b>	51	42	36	30	27	24
	37	50	75	<b>75</b>	63.7	52.5	45	37.5	33.7	30
FSE	45	60	90	<b>90</b>	76.5	63	54	45	40.5	36
	55	75	110	<b>110</b>	93.5	77	66	55	49.5	44
FSF	75	100	145	<b>145</b>	123.2	101.5	87	72.5	65.2	58
	90	125	178	<b>178</b>	151	124.6	107	89	80.1	71.2
	110	150	<b>205</b>	143.5	103	82	–	–	–	–
	132	200	<b>250</b>	175	125	100	–	–	–	–
FSG	160	250	<b>302</b>	211.4	151	121	–	–	–	–
	200	300	<b>370</b>	259	185	148	–	–	–	–
	250	400	<b>477</b>	334	239	191	–	–	–	–
FSH <sup>3)</sup>	315	400	<b>585</b>	468	–	–	–	–	–	–
	355	450	<b>655</b>	524	–	–	–	–	–	–
	400	500	<b>735</b>	588	–	–	–	–	–	–
FSJ <sup>3)</sup>	450	500	<b>840</b>	672	–	–	–	–	–	–
	500	600	<b>910</b>	728	–	–	–	–	–	–
	560	700	<b>1021</b>	817	–	–	–	–	–	–

The rated output currents in **bold** apply for the standard pulse frequency.

<sup>1)</sup> Rated power based on the base-load current  $I_L$ . The base-load current  $I_L$  is based on the duty cycle for low overload (LO).

<sup>2)</sup> Frame sizes FSA to FSG: Output current based on the base-load current  $I_L$ . The base-load current  $I_L$  is based on the duty cycle for low overload (LO). Frame sizes FSH and FSJ: Output current based on the rated output current  $I_{rated}$ . The rated output current  $I_{rated}$  can be used up to 100 %; however, without overload.

<sup>3)</sup> In the factory setting, these converters start at a pulse frequency of 4 kHz and reduce it automatically under load to the associated required frequencies. As the load decreases, the pulse frequency increases automatically up to 4 kHz.

## SINAMICS G120X infrastructure converters for HVAC/Water/Wastewater

0.75 kW to 630 kW (1 hp to 700 hp)

### SINAMICS G120X infrastructure converters for HVAC/Water/Wastewater

#### Characteristic curves (continued)

Frame size	Rated power <sup>1)</sup> at 50 Hz 690 V 3 AC		Rated output current in A (at an ambient temperature of 45 °C (113 °F)) for a pulse frequency of							
	kW	hp	2 kHz	4 kHz	6 kHz	8 kHz	10 kHz	12 kHz	14 kHz	16 kHz
FSD	3	4	<b>6</b>	3.6	–	–	–	–	–	–
	4	5	<b>7</b>	4.2	–	–	–	–	–	–
	5.5	7.5	<b>10</b>	6	–	–	–	–	–	–
	7.5	10	<b>13</b>	7.8	–	–	–	–	–	–
	11	10	<b>16</b>	9.6	–	–	–	–	–	–
	15	15	<b>21</b>	12.6	–	–	–	–	–	–
	18.5	20	<b>25</b>	15	–	–	–	–	–	–
	22	25	<b>29</b>	17.4	–	–	–	–	–	–
	30	30	<b>38</b>	22.8	–	–	–	–	–	–
	37	40	<b>46</b>	27.6	–	–	–	–	–	–
FSE	45	50	<b>58</b>	34.8	–	–	–	–	–	–
	55	60	<b>68</b>	40.8	–	–	–	–	–	–
FSF	75	75	<b>90</b>	54	–	–	–	–	–	–
	90	100	<b>112</b>	67.2	–	–	–	–	–	–
	110	125	<b>128</b>	76.8	–	–	–	–	–	–
	132	150	<b>158</b>	94.8	–	–	–	–	–	–
FSG	160	150	<b>196</b>	118	–	–	–	–	–	–
	200	200	<b>236</b>	142	–	–	–	–	–	–
	250	250	<b>288</b>	173	–	–	–	–	–	–
FSH <sup>2)</sup>	315	350	<b>330</b>	215	–	–	–	–	–	–
	355	400	<b>385</b>	250	–	–	–	–	–	–
	400	450	<b>420</b>	273	–	–	–	–	–	–
	450	500	<b>470</b>	306	–	–	–	–	–	–
FSJ <sup>2)</sup>	500	500	<b>520</b>	338	–	–	–	–	–	–
	560	600	<b>580</b>	377	–	–	–	–	–	–
	630	700	<b>650</b>	423	–	–	–	–	–	–

The rated output currents in **bold** apply for the standard pulse frequency.

<sup>1)</sup> Rated power based on the base-load current  $I_L$ . The base-load current  $I_L$  is based on the duty cycle for low overload (LO).

<sup>2)</sup> In the factory setting, these converters start at a pulse frequency of 4 kHz and reduce it automatically under load to the associated required frequencies. As the load decreases, the pulse frequency increases automatically up to 4 kHz. The values of the rated currents apply to a pulse frequency of 2 kHz and are reached at any time by automatic adaptation of the output pulse frequency.

## SINAMICS G120X infrastructure converters for HVAC/Water/Wastewater

0.75 kW to 630 kW (1 hp to 700 hp)

### SINAMICS G120X infrastructure converters for HVAC/Water/Wastewater

#### Characteristic curves (continued)

##### Ambient temperature

##### Frame sizes FSA to FSG:

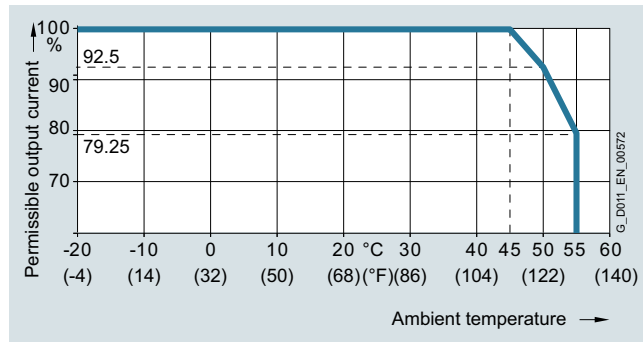

Permissible output current as a function of ambient temperature for SINAMICS G120X, frame sizes FSA to FSG, for low overload (LO)

##### Frame sizes FSH and FSJ:

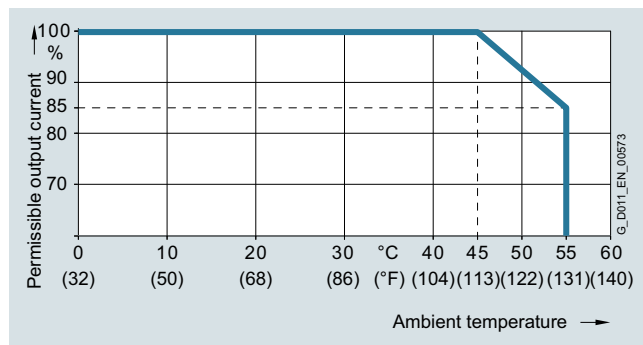

Permissible output current as a function of ambient temperature for SINAMICS G120X, frame sizes FSH and FSJ, for low overload (LO)

The operating temperature ranges of the operator panels should be taken into account. The temperature ranges are specified in the [Technical specifications](#) section under [Operator panels](#).

##### Installation altitude

##### Frame sizes FSA to FSJ:

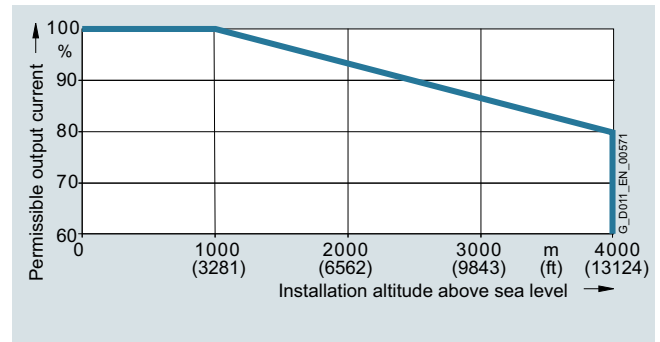

Permissible output current as a function of installation altitude for SINAMICS G120X for low overload (LO)

The connected motors, power elements and components must be considered separately.

Permissible line supplies as a function of the installation altitude

- Installation altitude up to 2000 m (6562 ft) above sea level
  - Connection to every supply system permitted for the converter
- Installation altitudes between 2000 m (6562 ft) and 4000 m (13124 ft) above sea level
  - Connection only to a TN system with grounded neutral point
  - TN systems with grounded line conductor are not permitted
  - The TN line system with grounded neutral point can also be supplied using an isolation transformer
  - The phase-to-phase voltage does not have to be reduced

When using converters on TN systems with voltages  $\geq 600$  V and at installation altitudes of 2000 m to 4000 m, the TN line supply must have a grounded neutral point established using an isolation transformer.



## SINAMICS G120X infrastructure converters for HVAC/Water/Wastewater

0.75 kW to 630 kW (1 hp to 700 hp)

### SINAMICS G120X infrastructure converters for HVAC/Water/Wastewater

#### Characteristic curves (continued)

##### System operating voltage

#### 400 V converters frame sizes FSA to FSG:

(Available soon)

#### 400 V converters frame sizes FSH and FSJ:

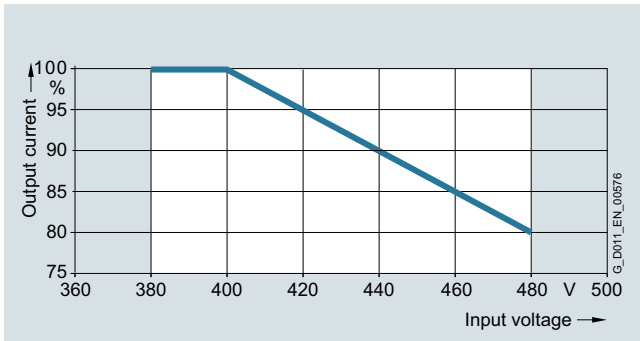

Permissible output current as a function of input voltage for 400 V SINAMICS G120X converters, frame sizes FSH and FSJ, for low overload (LO)

#### 600 V converters frame sizes FSA to FSG:

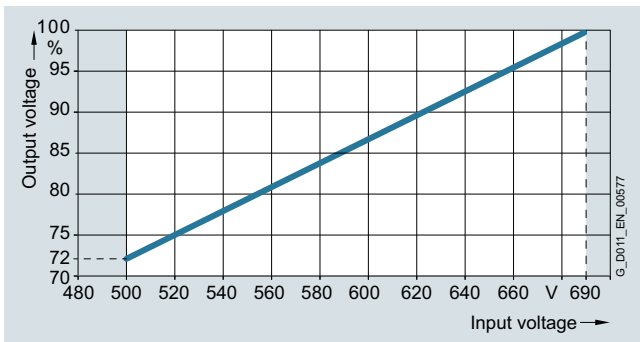

Permissible output voltage as a function of input voltage for 600 V SINAMICS G120X converters, frame sizes FSA to FSG, for low overload (LO)

#### 600 V converters frame sizes FSH and FSJ:

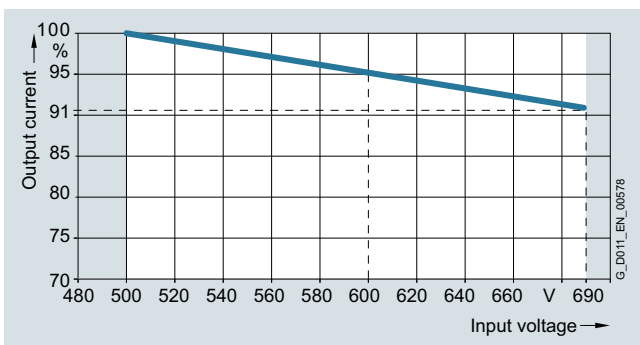

Permissible output current as a function of input voltage for 600 V SINAMICS G120X converters, frame sizes FSH and FSJ, for low overload (LO)

## SINAMICS G120X infrastructure converters for HVAC/Water/Wastewater

0.75 kW to 630 kW (1 hp to 700 hp)

### SINAMICS G120X infrastructure converters for HVAC/Water/Wastewater

#### Dimensional drawings

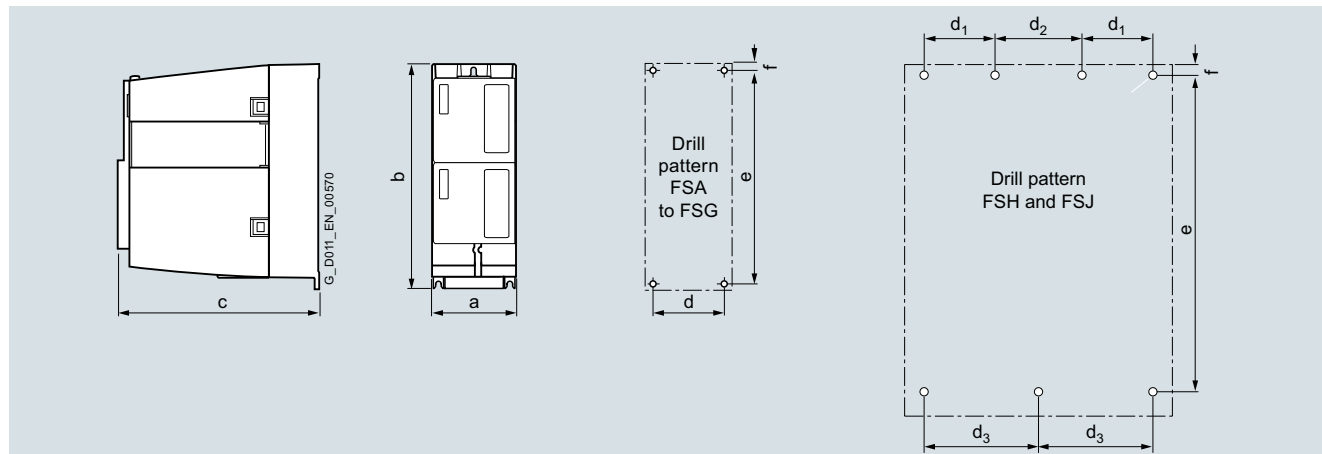

Principle dimension drawing and drill pattern for SINAMICS G120X

Frame size	Dimensions in mm (inches)			Drilling dimensions in mm (inches)						Cooling clearance <sup>2)</sup> in mm (inches)			Mounting With screws (plus washers and nuts)
	a (width)	b (height)	c (depth) <sup>1)</sup>	d	d <sub>1</sub>	d <sub>2</sub>	d <sub>3</sub>	e	f	top	bottom	front	
FSA	73 (2.87)	232 (9.13)	209 (8.23)	55 (2.17)	-	-	-	221.5 (8.72)	5.5 (0.22)	80 (3.15)	100 (3.94)	0 (0)	4 × M4
FSB	100 (3.94)	275 (10.83)	209 (8.23)	80 (3.15)	-	-	-	265 (10.43)	7 (0.28)	80 (3.15)	100 (3.94)	0 (0)	4 × M4
FSC	140 (5.51)	295 (11.61)	209 (8.23)	118 (4.65)	-	-	-	283 (11.14)	7 (0.28)	80 (3.15)	100 (3.94)	0 (0)	4 × M5
FSD	200 (7.87)	472 (18.58)	239 (9.41)	170 (6.69)	-	-	-	430 (16.93)	15 (0.59)	300 (11.81)	350 (13.78)	0 (0)	4 × M5
FSE	275 (10.83)	551 (21.69)	239 (9.41)	230 (9.06)	-	-	-	509 (20.04)	11 (0.43)	300 (11.81)	350 (13.78)	0 (0)	4 × M6
FSF	305 (12.01)	709 (27.91)	360 (14.17)	270 (10.63)	-	-	-	680 (26.77)	16.6 (0.65)	300 (11.81)	350 (13.78)	0 (0)	4 × M8
FSG	305 (12.01)	999 (39.33)	360 (14.17)	265 (10.43)	-	-	-	970.5 (38.21)	18.5 (0.73)	300 (11.81)	350 (13.78)	0 (0)	4 × M10
FSH	548 (21.57)	1696 (66.77)	393 (15.47)	-	160 (6.3)	150 (5.91)	225 (8.86)	1419 (55.87)	21 (0.83)	200 (7.87)	250 (9.84)	100 (3.94)	7 × M8
FSJ	801 (31.54)	1621 (63.82)	393 (15.47)	-	200 (7.87)	290 (11.42)	345 (13.58)	1399 (55.08)	21 (0.83)	200 (7.87)	250 (9.84)	100 (3.94)	7 × M8

<sup>1)</sup> Increased depth for frame sizes FSA to FSG:

- When the operator panel is plugged on, the depth increases by 9 mm (0.35 in)
- When SINAMICS G120 Smart Access is plugged on, the depth increases by 7 mm (0.28 in)

<sup>2)</sup> The converters in frame sizes FSA to FSG can be mounted side by side. A side clearance of 1 mm (0.04 in) is recommended for tolerance-related reasons. A side clearance of 30 mm (1.18 in) is required between the converters for frame sizes FSH and FSJ.

## SINAMICS G120X infrastructure converters for HVAC/Water/Wastewater 0.75 kW to 630 kW (1 hp to 700 hp)

### SINAMICS G120X infrastructure converters for HVAC/Water/Wastewater

#### More information

**Compact Installation Instructions** are supplied in hard copy form in German and English with every SINAMICS G120X. Further documentation, such as the operating instructions, is available free on the Internet at:

[www.siemens.com/sinamics-g120x/documentation](http://www.siemens.com/sinamics-g120x/documentation)

Detailed information on the SINAMICS G120X infrastructure converters for HVAC/Water/Wastewater, including the latest technical documentation (brochures, tutorials, dimensional drawings, certificates and operating instructions), is available on the Internet at:

[www.siemens.com/sinamics-g120x](http://www.siemens.com/sinamics-g120x)

and is also available via the Drive Technology Configurator (DT Configurator) on the Internet.

The DT Configurator can be found in the Siemens Industry Mall at the following address:

[www.siemens.com/dt-configurator](http://www.siemens.com/dt-configurator)

## SINAMICS G120X infrastructure converters for HVAC/Water/Wastewater

0.75 kW to 630 kW (1 hp to 700 hp)

### Supplementary system components > Operator panels

#### Overview

Operator panel	IOP-2 and IOP-2 Handheld Intelligent Operator Panel	BOP-2 Basic Operator Panel
Description	 <p data-bbox="440 719 999 825">Thanks to the high-contrast color display, menu-based operation and the wizards, commissioning of the standard drives is easy. Application wizards guide the user through the commissioning of important applications such as pumps, fans, compressors, or conveyor systems.</p>	 <p data-bbox="1007 719 1457 868">Commissioning of standard drives is easy with the menu-prompted dialog on a 2-line display. Simultaneous display of the parameter and parameter value, as well as parameter filtering, means that basic commissioning of a drive can be performed easily and, in most cases, without a printed parameter list.</p>
Possible applications	<ul data-bbox="440 874 999 1087" style="list-style-type: none"> <li>• Can be mounted directly on the converter</li> <li>• Can be mounted in a control cabinet door using a door mounting kit (achievable degree of protection is IP55/UL Type 12 enclosure)</li> <li>• Available as handheld version</li> <li>• The following languages are integrated in the IOP-2: English, German, French, Italian, Spanish, Portuguese, Dutch, Swedish, Finnish, Russian, Czech, Polish, Turkish, Chinese Simplified</li> </ul>	<ul data-bbox="1007 874 1457 970" style="list-style-type: none"> <li>• Can be mounted directly on the converter</li> <li>• Can be mounted in the control cabinet door using a door mounting kit (achievable degree of protection is IP55/UL Type 12)</li> </ul>
Quick commissioning without expert knowledge	<ul data-bbox="440 1093 999 1364" style="list-style-type: none"> <li>• Standard commissioning using the clone function</li> <li>• For quicker access, the parameter block names can be directly entered respectively changed on the IOP-2 using the virtual keyboard.</li> <li>• User-defined parameter list with a reduced number of self-selected parameters</li> <li>• Simple commissioning of standard applications using application-specific wizards; it is not necessary to know the parameter structure</li> <li>• Simple local commissioning using the handheld version</li> <li>• Commissioning is possible largely without documentation</li> </ul>	<ul data-bbox="1007 1093 1457 1115" style="list-style-type: none"> <li>• Standard commissioning using the clone function</li> </ul>
High degree of operator friendliness and intuitive operation	<ul data-bbox="440 1370 999 1583" style="list-style-type: none"> <li>• Intuitive navigation by operating with a sensor control field</li> <li>• Graphic color display to show status values such as pressure or flow rate in the form of scalar values, bar-type diagrams, or trend displays</li> <li>• Status display with freely selectable units to specify physical values</li> <li>• Direct manual operation of the drive – you can simply toggle between the automatic and manual modes</li> <li>• Simple cloning of specific settings of the IOP-2 user interface.</li> </ul>	<ul data-bbox="1007 1370 1457 1508" style="list-style-type: none"> <li>• 2-line display for showing up to 2 process values with text</li> <li>• Status display of predefined units</li> <li>• Direct manual operation of the drive – you can simply toggle between the automatic and manual modes</li> </ul>
Minimization of maintenance times	<ul data-bbox="440 1589 999 1727" style="list-style-type: none"> <li>• Diagnostics using plain text display, can be used locally on-site without documentation</li> <li>• The support function is used to determine the drive data for the Power Module, Control Unit and IOP-2 and makes this available as a two-dimensional code (data matrix/QR code)</li> <li>• Easily upgradable to new functional status via USB interface</li> </ul>	<ul data-bbox="1007 1589 1457 1632" style="list-style-type: none"> <li>• Diagnostics with menu prompting with 7-segment display</li> </ul>

# SINAMICS G120X infrastructure converters for HVAC/Water/Wastewater

0.75 kW to 630 kW (1 hp to 700 hp)

Supplementary system components > IOP-2 Intelligent Operator Panel

## Overview

### IOP-2 Intelligent Operator Panel



IOP-2 Intelligent Operator Panel

The Intelligent Operator Panel IOP-2 is a very user-friendly and powerful operator panel for the SINAMICS G120, SINAMICS G120C, SINAMICS G120X, SINAMICS G110D, SINAMICS G120D, SINAMICS G110M and SIMATIC ET 200pro FC-2.

The IOP-2 supports both newcomers and drive experts. Thanks to the membrane keyboard with a central sensor control field, high-contrast color displays, menu-based operation and application wizards, it is easy to commission drives. A drive can be essentially commissioned without having to use a printed parameter list – as the parameters are displayed in plain text, and explanatory help texts and the parameter filtering function are provided.

Application wizards interactively guide you when commissioning important applications such as conveyor technology, pumps, fans and compressors. There is a basic commissioning wizard for general commissioning.

Up to two process values can be graphically visualized and up to four process values can be numerically visualized on the status screen/display. Process values can also be displayed in technological units.

The IOP-2 supports standard commissioning of identical drives. For this purpose, a parameter list can be copied from a converter into the IOP-2 and downloaded into other drive units of the same type as required.

The IOP-2 can be installed in control cabinet doors using the optionally available door mounting kit.

#### Updating the IOP-2

The IOP-2 can be updated and expanded using the integrated USB interface.

Data to support future drive systems can be transferred from the PC to the IOP-2. Further, the USB interface allows user languages and wizards that will become available in the future to be subsequently downloaded and the firmware to be updated for the IOP-2<sup>1)</sup>.

The IOP-2 is supplied with power via the USB interface during an update.

### IOP-2 Handheld



IOP-2 Handheld

A handheld version of the IOP-2 can be ordered for mobile use. In addition to the IOP-2, it includes a housing with rechargeable batteries, a charging unit, an RS232 connecting cable, and a USB cable. The charging unit is supplied with connector adapters for Europe, the US and UK. When the batteries are fully charged, the operating time is up to 10 hours.

To connect the IOP-2 Handheld to SINAMICS G110D, SINAMICS G120D, SINAMICS G110M and SIMATIC ET 200pro FC-2, the RS232 connecting cable with optical interface is required in addition.

2

<sup>1)</sup> Information on updates for the IOP-2 is available at <https://support.industry.siemens.com/cs/document/67273266>

## SINAMICS G120X infrastructure converters for HVAC/Water/Wastewater

0.75 kW to 630 kW (1 hp to 700 hp)

### Supplementary system components > IOP-2 Intelligent Operator Panel

#### Selection and ordering data

Description	Article No.
<b>IOP-2 Intelligent Operator Panel</b> For use with SINAMICS G120 SINAMICS G120C SINAMICS G120X SINAMICS G110D SINAMICS G120D SINAMICS G110M SIMATIC ET 200pro FC-2 Operating languages: English, German, French, Italian, Spanish, Portuguese, Dutch, Swedish, Finnish, Russian, Czech, Polish, Turkish, Chinese Simplified	<b>6SL3255-0AA00-4JA2</b>
<b>IOP-2 Handheld</b> For use with SINAMICS G120 SINAMICS G120C SINAMICS G120X SINAMICS G110D SINAMICS G120D SINAMICS G110M SIMATIC ET 200pro FC-2 Included in the scope of delivery: <ul style="list-style-type: none"> <li>• IOP-2</li> <li>• Handheld housing</li> <li>• Rechargeable batteries (4 x AA)</li> <li>• Charging unit (international)</li> <li>• RS232 connecting cable <sup>1)</sup> 3 m (9.84 ft) long, can be used in combination with SINAMICS G120, SINAMICS G120C, SINAMICS G120X</li> <li>• USB cable 1 m (3.28 ft) long</li> </ul>	<b>6SL3255-0AA00-4HA1</b>
<b>Accessories</b>	
<b>Door mounting kit</b> For mounting an operator panel in control cabinet doors with sheet steel thicknesses of 1 ... 3 mm (0.04 in ... 0.12 in) Degree of protection IP55 Included in the scope of delivery: <ul style="list-style-type: none"> <li>• Seal</li> <li>• Mounting material</li> <li>• Connecting cable 5 m (16.4 ft) long, also supplies voltage to the IOP-2 directly via the converter</li> </ul>	<b>6SL3256-0AP00-0JA0</b>
<b>RS232 connecting cable</b> 2.5 m (8.20 ft) long, with optical interface for connecting the IOP-2 Handheld to SINAMICS G110D, SINAMICS G120D, SINAMICS G110M, SIMATIC ET 200pro FC-2	<b>3RK1922-2BP00</b>

#### Benefits

- New device design
  - Intuitive user interface – membrane keyboard with central sensor control field
  - High-contrast color display with a range of display options
  - IOP-2 device design open for future functional expansions (e.g. device functions, wizards, languages)
  - Easily upgradable to new functional status via USB interface
- Commissioning
  - Simple commissioning via wizards
  - The "Fieldbus Interface Settings" wizard is used for easy configuration of the Ethernet interface
  - Fast standard commissioning of converters thanks to cloning function
  - For quicker access, the parameter block names can be directly entered respectively changed on the IOP-2 using the virtual keyboard.
  - Simple local commissioning on-site using the handheld version
- Operator control and monitoring
  - Simple, individual local drive control (start/stop, setpoint value specification, change in direction of rotation)
  - Application-specific scenarios such as operator concepts with additional external operating elements can be implemented easily
  - Simple cloning of specific settings of the IOP-2 user interface, such as status screen, language settings, lighting duration, date/time settings, parameter backup mode and "My Parameters" – settings made once can such be easily transferred to many further IOP-2 Intelligent Operator Panels
- Diagnostics
  - Rapid diagnostics thanks to on-site plain text display
  - Integrated plain text help function for local display and resolution of fault messages
- Support function
  - Used to determine the drive data for the Power Module, Control Unit and IOP-2 (article number, serial number, firmware version, error statuses) and makes this available as a two-dimensional code (data matrix/QR code)
  - Allows easy contact with Customer Support via a data matrix/QR code generated on the IOP-2
  - Quick access via mobile devices (e.g. smartphones, tablets) to product information, documentation, FAQs, contact persons via a two-dimensional code generated on the IOP-2 (data matrix/QR code)
  - Scanning and evaluating of the two-dimensional data matrix code using the Industry Online Support app (<https://support.industry.siemens.com/cs/ww/en/sc/2067>), see also: <https://support.industry.siemens.com/cs/document/109748340>

<sup>1)</sup> For use in conjunction with SINAMICS G110D, SINAMICS G120D, SINAMICS G110M and SIMATIC ET 200pro FC-2, the RS232 connecting cable with optical interface is required (Article No.: **3RK1922-2BP00**). The cable must be ordered separately.

# SINAMICS G120X infrastructure converters for HVAC/Water/Wastewater

0.75 kW to 630 kW (1 hp to 700 hp)

Supplementary system components > IOP-2 Intelligent Operator Panel

## Integration

### Using the IOP-2 with the converters

	<ul style="list-style-type: none"> <li>• SINAMICS G120 with CU230P-2, CU240E-2 or CU250S-2</li> <li>• SINAMICS G120C</li> <li>• SINAMICS G120X</li> </ul>	<ul style="list-style-type: none"> <li>• SINAMICS G110D</li> <li>• SINAMICS G120D</li> <li>• SINAMICS G110M</li> <li>• SIMATIC ET 200pro FC-2</li> </ul>
<b>Plugging the IOP-2 onto the converter</b> (Voltage supply via converter)	✓	–
<b>Door mounting of the IOP-2 with the door mounting kit</b> (Voltage supply via converter. For this purpose, the IOP-2 must be connected up by means of the connecting cable supplied with the door mounting kit.)	✓	–
<b>Mobile use of the IOP-2 Handheld</b> (supplied from rechargeable batteries)	✓	✓ (RS232 connecting cable with optical interface required, article number 3RK1922-2BP00)

### Door mounting

Using the optionally available door mounting kit, an operator panel can be simply mounted in a control cabinet door with just a few manual operations. In the case of door mounting, the IOP-2 Operator Panel achieves degree of protection IP55/UL Type 12 enclosure.

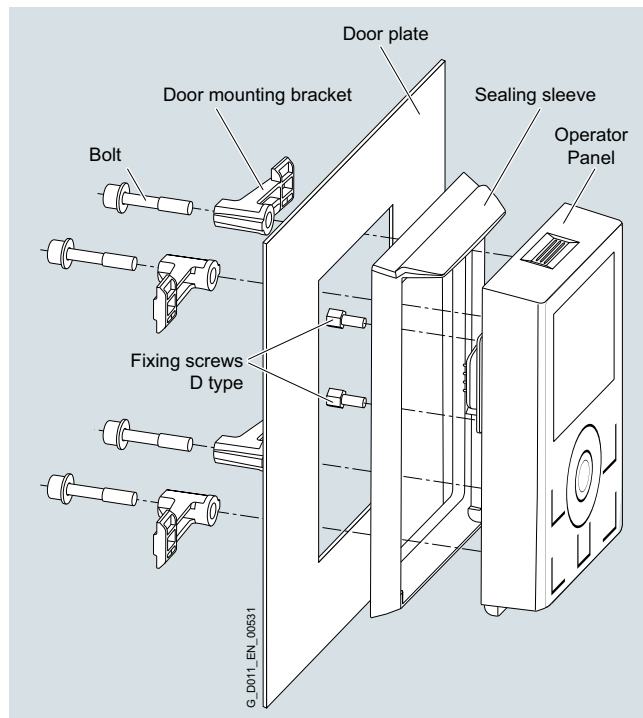

Door mounting kit with plugged-on IOP-2

## Technical specifications

	IOP-2 6SL3255-0AA00-4JA2	IOP-2 Handheld 6SL3255-0AA00-4HA1
<b>Display</b>	High-contrast color display, a variety of display options	
• Resolution	320 × 240 pixels	
<b>Operator panel</b>	Membrane keyboard with central sensor control field	
<b>Operating languages</b>	English, German, French, Italian, Spanish, Portuguese, Dutch, Swedish, Finnish, Russian, Czech, Polish, Turkish, Chinese Simplified	
<b>Ambient temperature</b>		
• During transport and storage	-40 ... +70 °C (-40 ... +158 °F)	-20 ... +55 °C (-4 ... +131 °F)
• During operation	For direct mounting on the converter: 0 ... 50 °C (32 ... 122 °F) For installation with door mounting kit: 0 ... 55 °C (32 ... 131 °F)	0 ... 40 °C (32 ... 104 °F)
<b>Humidity</b>	Relative humidity < 95 %, non-condensing	
<b>Degree of protection</b>	For direct mounting on the converter: IP20 For installation with door mounting kit: IP55, UL Type 12 enclosure	IP20
<b>Dimensions (H × W × D)</b>	106.86 × 70 × 19.65 mm (4.21 × 2.76 × 0.77 in)	195.04 × 70 × 37.58 mm (7.68 × 2.76 × 1.48 in)
<b>Weight, approx.</b>	0.134 kg (0.3 lb)	0.724 kg (1.6 lb)
<b>Compliance with standards</b>	CE, RCM, cULus, EAC, KC-REM-S49-SINAMICS	

## SINAMICS G120X infrastructure converters for HVAC/Water/Wastewater

0.75 kW to 630 kW (1 hp to 700 hp)

### Supplementary system components > BOP-2 Basic Operator Panel

#### Overview



BOP-2 Basic Operator Panel

The BOP-2 Basic Operator Panel can be used to commission drives, monitor drives in operation and input individual parameter settings.

Commissioning of standard drives is easy with the menu-prompted dialog on a 2-line display. Simultaneous display of the parameter and parameter value, as well as parameter filtering, means that basic commissioning of a drive can be performed easily and, in most cases, without a printed parameter list.

The drives are easily controlled manually using directly assigned navigation buttons. The BOP-2 has a dedicated switchover button to switch from automatic to manual mode.

Diagnostics can easily be performed on the connected converter by following the menus.

Up to two process values can be numerically visualized simultaneously.

BOP-2 supports standard commissioning of identical drives. For this purpose, a parameter list can be copied from a converter into the BOP-2 and when required, downloaded into other drive units of the same type.

The operating temperature of the BOP-2 is 0 °C ... 50 °C (32 °F ... 122 °F).

#### Selection and ordering data

Description	Article No.
<b>BOP-2 Basic Operator Panel</b>	<b>6SL3255-0AA00-4CA1</b>
<b>Accessories</b>	
<b>Door mounting kit</b> For mounting an operator panel in control cabinet doors with sheet steel thicknesses of 1 ... 3 mm (0.04 ... 0.12 in) Degree of protection IP55 Included in the scope of delivery:	<b>6SL3256-0AP00-0JA0</b>
<ul style="list-style-type: none"> <li>• Seal</li> <li>• Mounting material</li> <li>• Connecting cable 5 m/16.4 ft long, also supplies voltage to the operator panel directly via the converter</li> </ul>	

#### Benefits

- Shorten commissioning times – Easy commissioning of standard drives using basic commissioning wizards (setup)
- Minimize standstill times – Fast detection and rectification of faults (Diagnostics)
- Greater transparency in the process – The status display of the BOP-2 makes process variable monitoring easy (Monitoring)
- Direct mounting on the converter
- User-friendly user interface:
  - Easy navigation using clear menu structure and clearly assigned control keys
  - Two-line display



# SINAMICS G120X infrastructure converters for HVAC/Water/Wastewater

0.75 kW to 630 kW (1 hp to 700 hp)

## Supplementary system components > Memory cards

### Overview



SINAMICS SD memory card

The parameter settings for a converter can be stored on the SINAMICS SD memory card. When service is required, e.g. after the converter has been replaced and the data have been downloaded from the memory card, the drive system is immediately ready for use again.

- Parameter settings can be written from the memory card to the converter or saved from the converter to the memory card.
- Up to 100 parameter sets can be stored.
- The memory card supports standard commissioning without the use of an operator panel such as the IOP-2 or BOP-2.
- If firmware is stored on the memory card, the firmware can be upgraded/downgraded during power-up.

#### Note:

The memory card is not required for operation and does not have to remain inserted.

### Selection and ordering data

Description	Article No.
<b>SINAMICS SD card</b> 512 MB, empty	<b>6SL3054-4AG00-2AA0</b>

## SINAMICS G120X infrastructure converters for HVAC/Water/Wastewater

0.75 kW to 630 kW (1 hp to 700 hp)

Supplementary system components > SINAMICS G120 Smart Access

### Overview



SINAMICS G120 Smart Access

It is also easy and convenient to commission and operate the SINAMICS G120, SINAMICS G120C and SINAMICS G120X converters of firmware V4.7 SP6 and higher using the web server module SINAMICS G120 Smart Access and a connected smartphone, tablet or laptop.

### Benefits

- Wireless commissioning, operation and diagnostics via mobile device or laptop thanks to the optional SINAMICS G120 Smart Access
- Easy access to the converter in difficult-to-access areas
- Intuitive user interface and commissioning wizard
- Free choice of terminal devices as the web server works with all common web browsers, such as iOS, Android, Windows, Linux and Mac OS

### Function

- Commissioning using commissioning wizard
- Setting and saving parameters
- Testing motor in JOG mode
- Monitoring of converter data
- Quick diagnostics
- Saving the settings and restoring to factory settings

### Selection and ordering data

Description	Article No.
<b>SINAMICS G120 Smart Access</b> For wireless commissioning, operation and diagnostics of the following converters using a smartphone, tablet or laptop <ul style="list-style-type: none"> <li>• SINAMICS G120C</li> <li>• SINAMICS G120 together with the CU230P-2 and CU240E-2 Control Units (without fail-safe versions)</li> <li>• SINAMICS G120X</li> </ul>	6SL3255-0AA00-5AA0

### Technical specifications

	<b>SINAMICS G120 Smart Access</b> 6SL3255-0AA00-5AA0
<b>Operating system</b>	iOS, Android, Windows, Linux, Mac OS
<b>Languages</b>	Support of six languages: English, French, German, Italian, Spanish, Chinese
<b>Ambient temperature</b>	<ul style="list-style-type: none"> <li>• During storage and transport: -40 ... +70 °C (-40 ... +158 °F)</li> <li>• During operation: 0 ... 50 °C (32 ... 122 °F) if the Smart Access is plugged directly into the converter</li> </ul>
<b>Humidity</b>	< 95 %, non-condensing
<b>Degree of protection</b>	Depending on the degree of protection of the converter, max. IP55/UL Type 12 enclosure
<b>Dimensions</b>	<ul style="list-style-type: none"> <li>• Width: 70 mm (2.76 in)</li> <li>• Height: 108.9 mm (4.29 in)</li> <li>• Depth: 17.3 mm (0.68 in)</li> </ul>
<b>Weight, approx.</b>	0.08 kg (0.18 lb)
<b>Compliance with standards</b>	CE, FCC, SRRC, WPC, ANATEL, BTK

### Integration



SINAMICS G120X frame size FSD with plugged-on SINAMICS G120 Smart Access

The optional SINAMICS G120 Smart Access is simply plugged onto the converter and is available for the following converters of firmware V4.7 SP6 and higher.

- SINAMICS G120C
- SINAMICS G120 together with the CU230P-2 and CU240E-2 Control Units (without fail-safe versions)
- SINAMICS G120X

## SINAMICS G120X infrastructure converters for HVAC/Water/Wastewater

0.75 kW to 630 kW (1 hp to 700 hp)

### Supplementary system components > Push-through mounting frames for frame sizes FSA to FSG

#### Overview

The optional push-through mounting frame is used to install a SINAMICS G120X converter, frame sizes FSA to FSG, in a control cabinet with the heat sink outside the control cabinet. The converter achieves degree of protection IP20/UL Open Type with push-through installation.

For push-through installation of frame sizes FSD to FSG, installation handles are available for insertion without the need for a lifting device.

#### Selection and ordering data

Description	Article No.
<b>Push-through mounting frames</b> (available soon) for SINAMICS G120X degree of protection IP20/UL Open Type	
• Frame size FSA	<b>6SL3261-6GA00-0BA0</b>
• Frame size FSB	<b>6SL3261-6GB00-0BA0</b>
• Frame size FSC	<b>6SL3261-6GC00-0BA0</b>
• Frame size FSD	<b>6SL3261-6GD00-0BA0</b>
• Frame size FSE	<b>6SL3261-6GE00-0BA0</b>
• Frame size FSF	<b>6SL3261-6GF00-0BA0</b>
• Frame size FSG	<b>6SL3261-6GG00-0BA0</b>
<b>Accessories</b>	
<b>Installation handles</b> (available soon) for SINAMICS G120X frame sizes FSD to FSF	<b>6SL3200-0SM22-0AA0</b>

### Supplementary system components > IP21 top covers for frame sizes FSA to FSG

#### Overview

Using the optional IP21 top cover, SINAMICS G120X converters in frame sizes FSA to FSG achieve degree of protection 21. With wall mounting, the IP21 top cover has to be installed above the converter.

#### Selection and ordering data

Description	Article No.
<b>IP21 top covers</b> (available soon) for SINAMICS G120X degree of protection IP20/UL Open Type	
• Frame size FSA	<b>6SL3266-1PA00-0BA0</b>
• Frame size FSB	<b>6SL3266-1PB00-0BA0</b>
• Frame sizes FSC and FSD	<b>6SL3266-1PD00-0BA0</b>
• Frame size FSE	<b>6SL3266-1PE00-0BA0</b>
• Frame sizes FSF and FSG	<b>6SL3266-1PF00-0BA0</b>

### Supplementary system components > Installation kit for line-side cable connection, left, for frame size FSH

#### Overview

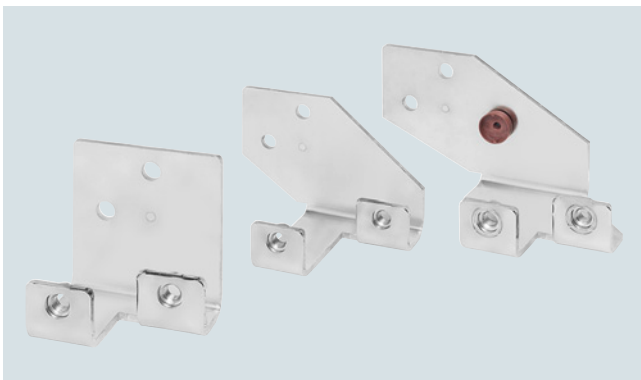

Installation kit for line-side cable connection, left, for SINAMICS G120X, frame size FSH

This installation kit allows supply cables of the SINAMICS G120X converter, frame size FSH, to be connected alternatively on the left-hand side of the converter. The converter can thus be installed higher in the control cabinet, allowing more efficient use of the available cabinet space. In many cases, use of this installation kit also helps in the implementation of effective cabinet cooling.

#### Selection and ordering data

Description	Article No.
<b>Installation kit for line-side cable connection, left</b> (available soon) for SINAMICS G120X frame size FSH	<b>6SL3366-1LH00-0PA0</b>

## SINAMICS G120X infrastructure converters for HVAC/Water/Wastewater

0.75 kW to 630 kW (1 hp to 700 hp)

### Spare parts > FPI board for frame sizes FSH and FSJ

#### Overview

The FPI board (freely-programmable interface board) is available as a spare part for the SINAMICS G120X converter, frame sizes FSH and FSJ. This is an interface board between Control Unit and Power Module with additional customer terminals (X9, X41).

#### Selection and ordering data

Description	Article No.
<b>FPI board</b> (available soon) for SINAMICS G120X frame sizes FSH and FSJ	available soon

### Spare parts > PSB board for frame sizes FSH and FSJ

#### Overview

The PSB board (power supply board) is available as a spare part for the SINAMICS G120X converter, frame sizes FSH and FSJ. This is an internal power supply with  $\pm 24$  V for the electronics and 56 V for a power unit fan.

#### Selection and ordering data

Description	Article No.
<b>PSB board</b> (available soon) for SINAMICS G120X frame sizes FSH and FSJ	available soon

### Spare parts > Current transformers for frame sizes FSH and FSJ

#### Overview

Current transformers are available as spare parts for the SINAMICS G120X converter, frame sizes FSH and FSJ. These are 2000 A or 1000 A current transformers for measuring the motor current at the device output. The current transformers are used for motor control and converter protection.

#### Selection and ordering data

Description	Article No.
<b>Current transformers</b> (available soon) for SINAMICS G120X	
• 2000 A for frame sizes FSH and FSJ	<b>6SL3200-0SE01-0AA0</b>
• 1000 A for frame size FSJ	<b>6SL3200-0SE02-0AA0</b>

### Spare parts > Spare parts kit for Control Unit

#### Overview

The spare parts kit contains small parts for the SINAMICS G120X Control Unit:

Included in the scope of delivery:

- 1x STO connecting plug for frame sizes FSA to FSC
- 3x replacement doors for the Control Unit
- 4x I/O terminals
- 1x screw for RS485 terminal
- 1x blanking cover
- Label set

#### Selection and ordering data

Description	Article No.
<b>Spare parts kit for Control Unit</b> (available soon) for SINAMICS G120X	<b>6SL3200-0SK10-0AA0</b>

### Spare parts > Shield connection kit for Control Unit

#### Overview

A shield connection kit for the Control Unit is supplied with the SINAMICS G120X converters, frame sizes FSD to FSG. It is advisable to install the supplied shield connection kit for EMC-compliant configuration of the converter. This shield connection kit can be ordered as a spare part.

The shield connection kit offers optimum shield connection and strain relief for all signal and communication cables.

The kit contains the following:

- a matching shield connection plate
- all of the necessary connecting and retaining elements for mounting

#### Selection and ordering data

Description	Article No.
<b>Shield connection kit for Control Unit</b> (available soon) for SINAMICS G120X frame sizes FSD to FSG	<b>6SL3264-1EA00-0YA0</b>

# SINAMICS G120X infrastructure converters for HVAC/Water/Wastewater

0.75 kW to 630 kW (1 hp to 700 hp)

## Spare parts > Shield connection kits for Power Module

### Overview

A shield connection kit is supplied with the SINAMICS G120X converters, frame sizes FSA to FSG. It is advisable to install the supplied shield connection kit for EMC-compliant configuration of the converter. These shield connection kits can be ordered as spare parts.

Please observe the notes included in the operating instructions for the SINAMICS G120X converters, frame sizes FSH and FSJ.

[www.siemens.com/sinamics-g120x/documentation](http://www.siemens.com/sinamics-g120x/documentation)

### Selection and ordering data

Description	Article No.
<b>Shield connection kits for Power Module</b> for SINAMICS G120X degree of protection IP20/UL Open Type	
• Frame size FSA (available soon)	<b>6SL3262-1AA01-0DA0</b>
• Frame size FSB (available soon)	<b>6SL3262-1AB01-0DA0</b>
• Frame size FSC (available soon)	<b>6SL3262-1AC01-0DA0</b>
• Frame size FSD	<b>6SL3262-1AD01-0DA0</b>
• Frame size FSE	<b>6SL3262-1AE01-0DA0</b>
• Frame size FSF	<b>6SL3262-1AF01-0DA0</b>
• Frame size FSG	<b>6SL3262-1AG01-0DA0</b>

## Spare parts > Mounting set for frame sizes FSD to FSG

### Overview

A **mounting set** can be ordered for SINAMICS G120 Power Modules PM240-2, SINAMICS G120C and SINAMICS G120X, in degree of protection IP20. It contains the following parts:

- 1 SUB-D connector with mounting material
- 1 motor connector and 1 power supply connector
- 2 serrated strips including mounting material for connecting the shield
- 3 sleeves for inserting in the cutouts for the signal cables of the cable bonding plate
- Ferrite cores  
(only necessary for devices with integrated line filter class B)
- Screws for fixing the cable bonding plate and the cover

### Selection and ordering data

Description	Article No.
<b>Mounting set</b> for SINAMICS G120 Power Modules PM240-2, SINAMICS G120C and SINAMICS G120X degree of protection IP20 in frame sizes FSD to FSG	<b>6SL3200-0SK08-0AA0</b>

## Spare parts > Terminal cover kits for frame sizes FSD to FSG

### Overview

The terminal cover kit includes a replacement cover for the connecting terminals.

Terminal cover kits, which are suitable for the following converters in frame sizes FSD to FSG, are available:

- SINAMICS G120 PM240-2 Power Modules
- SINAMICS G120 PM250 Power Modules
- SINAMICS G120C
- SINAMICS G120X

### Selection and ordering data

Description	Article No.
<b>Terminal cover kits for SINAMICS G120 PM240-2 Power Modules</b>	
• for frame size FSD	<b>6SL3200-0SM13-0AA0</b>
• for frame size FSE	<b>6SL3200-0SM14-0AA0</b>
• for frame size FSF	<b>6SL3200-0SM15-0AA0</b>
• for frame size FSG	<b>6SL3200-0SM16-0AA0</b>
<b>Terminal cover kits for SINAMICS G120 PM250 Power Modules</b>	
• for frame sizes FSD and FSE	<b>6SL3200-0SM11-0AA0</b>
• for frame size FSF	<b>6SL3200-0SM12-0AA0</b>
<b>Terminal cover kits for SINAMICS G120C</b>	
• for frame size FSD	<b>6SL3200-0SM13-0AA0</b>
• for frame size FSE	<b>6SL3200-0SM14-0AA0</b>
• for frame size FSF	<b>6SL3200-0SM15-0AA0</b>
<b>Terminal cover kits for SINAMICS G120X</b>	
• for frame size FSD	<b>6SL3200-0SM13-0AA0</b>
• for frame size FSE	<b>6SL3200-0SM14-0AA0</b>
• for frame size FSF	<b>6SL3200-0SM15-0AA0</b>
• for frame size FSG	<b>6SL3200-0SM16-0AA0</b>

**SINAMICS G120X infrastructure converters for HVAC/Water/Wastewater**

0.75 kW to 630 kW (1 hp to 700 hp)

Spare parts &gt; Fan units

**Overview**

The fans of the SINAMICS G120X converters are designed for extra long service life. For special requirements, replacement fans are available that can be exchanged quickly and easily.

**Selection and ordering data**

Description	Article No.
<b>External fan units</b> for SINAMICS G120X degree of protection IP20/UL Open Type	
• Frame size FSA (available soon)	<b>6SL3200-0SF52-0AA0</b>
• Frame size FSB (available soon)	<b>6SL3200-0SF53-0AA0</b>
• Frame size FSC (available soon)	<b>6SL3200-0SF54-0AA0</b>
• Frame size FSD	<b>6SL3200-0SF15-0AA0</b>
• Frame size FSE	<b>6SL3200-0SF16-0AA0</b>
• Frame size FSF	<b>6SL3200-0SF17-0AA0</b>
• Frame size FSG	<b>6SL3200-0SF18-0AA0</b>
• Frame sizes FSH and FSJ	<b>6SL3300-0SF01-0AA0</b>
<b>Internal fan unit</b> (available soon) for SINAMICS G120X degree of protection IP20/UL Open Type	
• Frame sizes FSH and FSJ	<b>6SL3200-0SF50-0AA0</b>

## Engineering tools

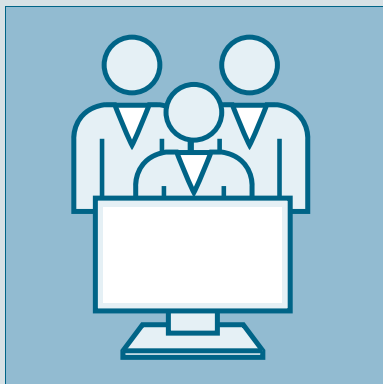
**SINAMICS ASSISTANT app**

The error code function of the SINAMICS ASSISTANT app helps you to identify and rectify errors. Just enter the error code of your frequency converter and the app shows you what sort of error it is and how you can rectify it.

This app also recalculates for you the frequency (Hz) of a frequency converter into the speed to be set on the motor (rpm) or vice versa.

In addition this app offers you a support page on which you can get in touch straight away with the right contact person in your region if you have any questions. Furthermore, video information is available to you free of charge, e.g. on installation and commissioning of the SINAMICS G120 frequency converter. You will find the free downloads for Android and for iOS at the following link: [www.siemens.com/sinamics-assistant](http://www.siemens.com/sinamics-assistant)

3/2	<b>Drive Technology Configurator</b>
3/3	<b>SIMARIS planning tools for systems with SINAMICS drives</b>
3/5	<b>SinaSave energy efficiency tool</b>
3/6	<b>SIZER for Siemens Drives engineering tool</b>
3/7	<b>SINAMICS web server for SINAMICS G120X via SINAMICS G120 Smart Access</b>

**Security information**

Siemens provides products and solutions with industrial security functions that support the secure operation of plants, systems, machines and networks.

In order to protect plants, systems, machines and networks against cyber threats, it is necessary to implement – and continuously maintain – a holistic, state-of-the-art industrial security concept. Siemens' products and solutions constitute one element of such a concept.

Customers are responsible for preventing unauthorized access to their plants, systems, machines and networks. Such systems, machines and components should only be connected to an enterprise network or the internet if and to the extent such a connection is necessary and only when appropriate security measures (e.g. firewalls and/or network segmentation) are in place.

For additional information on industrial security measures that may be implemented, please visit

<https://www.siemens.com/industrialsecurity>

Siemens' products and solutions undergo continuous development to make them more secure. Siemens strongly recommends that product updates are applied as soon as they are available and that the latest product versions are used. Use of product versions that are no longer supported, and failure to apply the latest updates may increase customer's exposure to cyber threats.

To stay informed about product updates, subscribe to the Siemens Industrial Security RSS Feed under

<https://www.siemens.com/industrialsecurity>

## Engineering tools

### Drive Technology Configurator

#### Overview

The Drive Technology Configurator (DT Configurator) helps you to configure the optimum drive technology products for your application – starting with gear units, motors, converters as well as the associated options and components and ending with controllers, software licenses and connection systems. Whether with little or detailed knowledge of products: preselected product groups, deliberate navigation through selection menus and direct product selection through entry of the article number support quick, efficient and convenient configuration.

In addition, comprehensive documentation comprising technical data sheets, 2D dimensional drawings/3D CAD models, operating instructions, certificates, etc. can be selected in the DT Configurator. Immediate ordering is possible by simply transferring a parts list to the shopping cart of the Industry Mall.

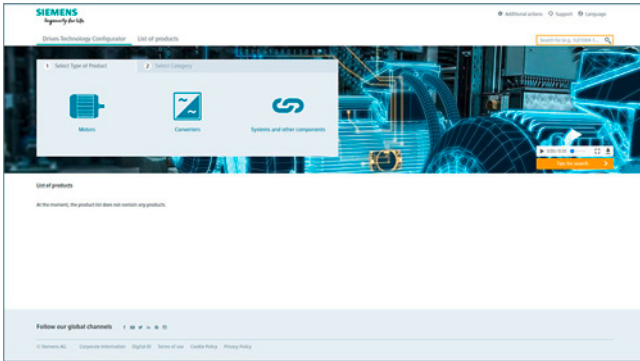

#### *Drive Technology Configurator for efficient drive configuration with the following functions*

- Quick and easy configuration of drive products and associated components – gear units, motors, converters, controllers, connection systems
- Configuration of drive systems for pumps, fans and compressor applications from 1 kW to 2.6 MW
- Retrievable documentation for configured products and components, such as
  - Data sheets in up to 9 languages in PDF or RTF format
  - 2D dimensional drawings/3D CAD models in various formats
  - Terminal box drawing and terminal connection diagram
  - Operating instructions
  - Certificates
  - Start-up calculation for SIMOTICS motors
  - EPLAN macros
- Support with retrofitting in conjunction with Spares On Web ([www.siemens.com/sow](http://www.siemens.com/sow))
- Ability to order products directly through the Siemens Industry Mall

#### Access to the Drive Technology Configurator

The Drive Technology Configurator can be called up without registration and without a login:  
[www.siemens.com/dt-configurator](http://www.siemens.com/dt-configurator)

#### Selection and ordering data

Description	Article No.
<b>Interactive Catalog CA 01</b> including Drive Technology Configurator	
• German (DVD-ROM – Edition Germany)	<b>E86060-D4001-A500-D9</b>
• German, English, French, Spanish (Download – without prices)	<b>E86060-D4001-A510-D8-7500</b>

#### More information

##### Online access to the Drive Technology Configurator

More information about the Drive Technology Configurator is available on the Internet at  
[www.siemens.com/dtconfigurator](http://www.siemens.com/dtconfigurator)

##### Offline access to the Drive Technology Configurator in the Interactive Catalog CA 01

In addition, the Drive Technology Configurator is also included in the Interactive Catalog CA 01 – the offline version of the Siemens Industry Mall.

The Interactive Catalog CA 01 can be ordered from the relevant Siemens sales office or via the Internet:  
[www.siemens.com/automation/CA01](http://www.siemens.com/automation/CA01)



## Overview

### *Electrical Planning: Simplified by Electrical Design Software!*

Electrical planning of power distribution systems in functional and industrial buildings has never been easy and is now more complex than ever. The electrical calculation software tools SIMARIS design for dimensioning and SIMARIS project for determination of the distribution boards' space requirements support technical planners with the electrical planning process with SINAMICS drives.

#### Supported SINAMICS drives:

- SINAMICS G120, SINAMICS G120D, SINAMICS G120X
- SINAMICS G110D, SINAMICS G110M
- SINAMICS G130, SINAMICS G150

## Overview

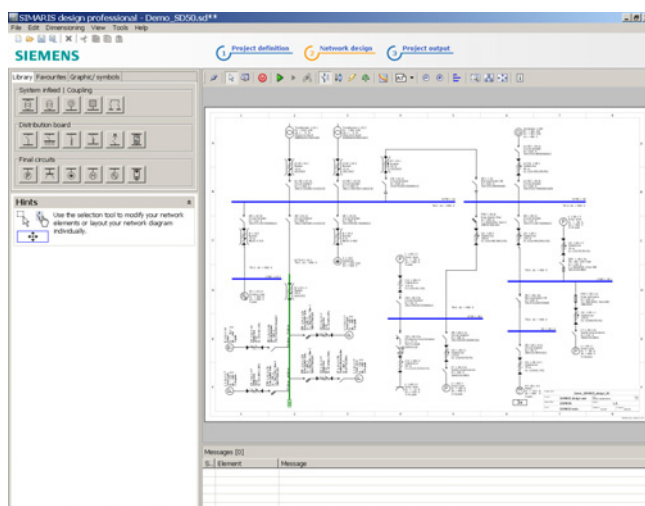

SIMARIS design is a planning tool for quick and effective network calculation and dimensioning of power distribution for non-residential and industrial buildings.

Starting in the planning phase, the entire electrical circuit required for the project can be structured and dimensioned on the basis of real products. For this purpose, the network structure is initially set up based on the stored modules for infeeds, couplings, distributors and branch circuits. It is also possible to reuse stored favorites, such as those processed for previous similar projects. Suitable components and distribution systems are then automatically selected from the product database stored in SIMARIS design based on the selected project-specific parameters and technical data. This precludes the extra costs so often incurred in the implementation phase as a result of systems that have not been correctly coordinated.

Any configuration of electric power distribution is subject to frequent change and adaptation, not only in the planning phase, but also in the implementation phase. SIMARIS design makes it easy to incorporate such changes in the supply concept and to automatically check their reliability in terms of sound engineering practice and the currently applicable standards.

SIMARIS design professional, a program version available for a fee, offers additional useful functions. It can be used to carry out and also document selectivity analyses, essential for safety power supply systems. There is also the option of analyzing and optimizing the energy efficiency of the planned network.

The versatile output variants enable precise documentation of the project structure and of the calculated data suitable for every phase of a project.

There is also the option of exporting the project data. This enables further processing of the planned project in SIMARIS project, and thus also supports and facilitates system planning.

## Benefits

- Reduction in processing overhead for projects
- Dimensioning of electrical networks on the basis of real products according to sound engineering practice and the currently applicable standards (VDE, IEC)
- Automatic selection of the correct components from medium voltage through to interfacing of the load from the stored product database, i.e. no detailed knowledge of products and systems required
- Open definition of the types of mains operation and switching states
- Calculation of the short circuit current, load flow, voltage drop and energy balance
- Incorporation of the required person, short circuit and overload protection
- Option of factoring in any necessary functional endurance
- Display and dimensioning of cable and busbar trunking systems for power conveyance and distribution
- High planning reliability coupled with flexibility in the planning and implementation process
- Tracking changes via change index possible
- Simple adaptation in the case of application changes or expansions
- Option for saving frequently required modules in the favorites library
- Output of the created network diagram, as well as detailed parts lists and data lists
- Incorporation of country-specific product portfolios
- Comprehensive documentation of planning results with simple data transfer (Office, CAD etc.)

## Application

SIMARIS design is a software tool for the network calculation and dimensioning of power distribution for non-residential and industrial buildings. Whether for a shopping center, a hospital or production facilities - with SIMARIS design you can reduce the overhead required for the overall planning of power distribution systems and hence the time spent on the selection and dimensioning of equipment.

## More information

For further information and available downloads, please go to: [www.siemens.com/simarisdg](http://www.siemens.com/simarisdg)

If you have any other questions, please do not hesitate to contact our Customer Support Center:

Phone: +49 70 00 7 46 27 47

Email: [technical-assistance@siemens.com](mailto:technical-assistance@siemens.com)

## Engineering tools

### SIMARIS planning tools for systems with SINAMICS drives > SIMARIS project

#### Overview

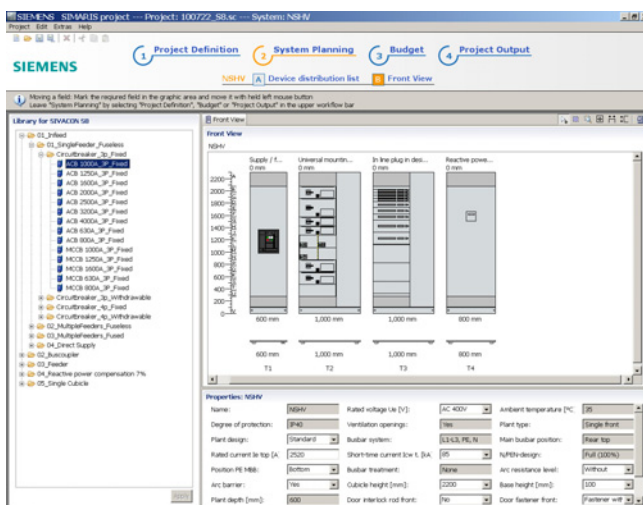

SIMARIS project is a planning tool for fast calculation of space requirements and electrical power distribution system budgets for non-residential and industrial buildings, and for generating specifications automatically.

The following is determined in SIMARIS project based on the pre-defined project structure and the basic technical specifications selected:

- For medium-voltage switchboards: selection of the required system and the required fields, then presentation of a front view with dimensions.
- Following selection of the system for transformers, the required quantity must be selected. Selected transformers are presented as a parts list.
- For low-voltage switchboards and distribution boards: selection of the required protection devices and switching devices per system. The most suitable distribution system is determined automatically based on the list of distribution devices thus created. It is then equipped with the devices and presented graphically in an automatically generated front view that includes dimensions.
- Following selection of the system for busbar trunking systems the length is specified and the additionally required components are selected, e.g. infeeds, junction units and tap-off units. All the resulting components are listed in a parts list.

Detailed information about Siemens devices or their article numbers is not needed because SIMARIS project makes the selection automatically on the basis of the parameters entered. For each item of switchboard or each distribution board, SIMARIS project takes the wiring, control and measurement etc. into account.

A system plan drawn up in SIMARIS design can also be imported into SIMARIS project, which means that selecting devices becomes redundant and SIMARIS project builds up the project structure automatically.

Convenient output versions are available to document the results, including the automatic generation of specifications for the planned systems.

Typical versions of a system planned in SIMARIS project can be saved and repeatedly integrated in new projects from the favorites library. Automatically created systems can also be subsequently optimized or changed. This is particularly relevant if planning becomes more detailed and the budget needs to be reinforced as a result.

For detailed calculation of costs - on an up-to-date and regional basis - and for more project support, please contact your Siemens representative.

#### Benefits

- Intuitive and easy to operate
- Automatic selection and placement of matching distribution systems
- Fast determination of the space requirements and cost of power distribution plants
- End-to-end planning, from medium-voltage switchgear assemblies, transformers, low-voltage switchgear and busbar trunking systems right through to the distribution boards
- Simple adaptation of project planning with increasing clarification of implementation requirements, but also in the event of application changes or expansions
- Saving planned systems for similar projects individually in the favorites library and importing them from there into new projects
- Option of factoring in functional endurance for busbar systems
- Convenient output versions for documentation, such as graphic views, lists and specifications
- Projects created in SIMARIS design can also be imported

#### Application

SIMARIS project is suitable for the fast determination of the space requirements and cost of electrical power distribution in all industrial and non-residential buildings and for the automatic generation of specifications. From shopping centers to hospitals and production buildings – with SIMARIS project it is possible to reduce the amount of work required for the overall planning of power distribution systems and hence the time spent on selecting and dimensioning the necessary equipment.

#### More information

For further information and available downloads, please go to: [www.siemens.com/simarispject](http://www.siemens.com/simarispject)

If you have any other questions, please do not hesitate to contact our Customer Support Center:

Phone: +49 70 00 7 46 27 47

Email: [technical-assistance@siemens.com](mailto:technical-assistance@siemens.com)

SinaSave energy efficiency tool

Overview

The SinaSave energy efficiency tool calculates potential energy savings and amortization times based on your individual conditions of use and therefore offers practical assistance in making decisions about investments in energy-efficient technologies.

From SinaSave Version 6.0 and higher, the drive systems to be compared and the relevant drive component parameters are displayed graphically. An additional expansion are the numerous comparison possibilities for different control types and comprehensive product combinations for drive solutions for pump and fan applications. In addition to SIMOTICS motors and SINAMICS drives, the product portfolio comprises SIRIUS switching devices, offering a comprehensive range of comparison possibilities – according to your individual requirements.



SinaSave offers numerous comparison scenarios:

- Comparison of drive systems for pump and fan applications in the output range from 0.55 kW (low voltage) to 5.5 MW (medium voltage) for
  - Reactor control (fixed speed; motor and switching device)
  - Bypass control (fixed speed; motor and switching device)
  - Speed control (variable speed; motor and frequency converter)
- Comparison and evaluation of standard motors (incl. ignition protection motors) in different energy efficiency classes



SinaSave supports the evaluation of the various comparisons of product and system by

- Displaying the potential savings for energy and energy costs, as well as CO<sub>2</sub> emissions
- Estimation of the amortization time
- Estimation of the individual total lifecycle costs
- Representation of the system power losses according to EN 50598-2 for full load and partial load
- Direct comparison of Siemens drives with the reference Power Drive System (PDS) described in EN 50598-2

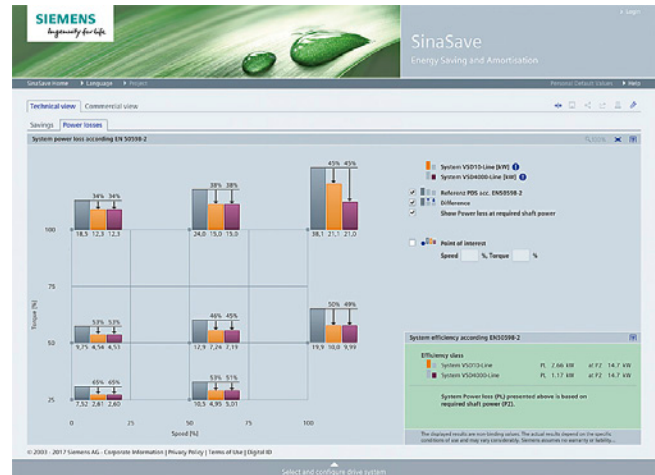

Access to the SinaSave energy efficiency tool

SinaSave can be accessed without the need for registration or logging in:

[www.automation.siemens.com/sinasave](http://www.automation.siemens.com/sinasave)

More information

For more information about the amortization calculator for energy-efficient drive systems, visit

[www.siemens.com/sinasave](http://www.siemens.com/sinasave)

More information about services for energy saving is available on the Internet at

[www.siemens.com/energysaving](http://www.siemens.com/energysaving)

## Engineering tools

### SIZER for Siemens Drives engineering tool

#### Overview

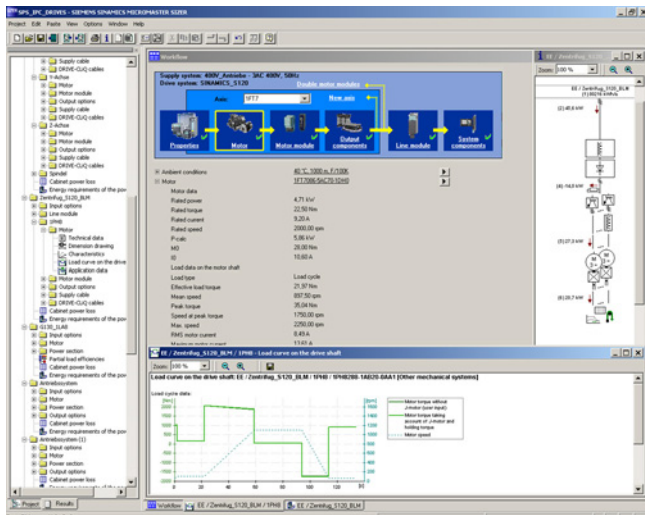

The following drives and controls can be engineered in a user-friendly way using the SIZER for Siemens Drives engineering tool:

- SIMOTICS low-voltage motors, including servo geared motors
- SIMOGEAR geared motors
- SINAMICS low-voltage drive systems
- Motor starters
- SINUMERIK CNC
- SIMOTION Motion Control controller
- SIMATIC controller

It provides support when selecting the technologies involved in the hardware and firmware components required for a drive task. SIZER for Siemens Drives covers the full range of operations required to configure a complete drive system, from basic single drives to demanding multi-axis applications.

SIZER for Siemens Drives supports all of the engineering steps in one workflow:

- Configuring the power supply
- Designing the motor and gearbox, including calculation of mechanical transmission elements
- Configuring the drive components
- Compiling the required accessories
- Selecting the line-side and motor-side power options, e.g. cables, filters, and reactors

When SIZER for Siemens Drives was being designed, particular importance was placed on a high degree of usability and a universal, function-based approach to the drive application. The extensive user guidance makes it easy to use the tool. Status information keeps you continually informed about the progress of the configuration process.

The drive configuration is saved in a project. In the project, the components and functions used are displayed in a hierarchical tree structure.

The project view permits the configuration of drive systems and the copying/inserting/modifying of drives already configured.

The configuration process produces the following results:

- A parts list of the required components (export to Excel, use of the Excel data sheet for import to SAP)
- Technical specifications of the system
- Characteristic curves
- Comments on system reactions
- Mounting arrangement of drive and control components and dimensional drawings of motors
- Energy requirements of the configured application

These results are displayed in a results tree and can be reused for documentation purposes.

Support is provided by the technological online help menu:

- Detailed technical specifications
- Information about the drive systems and their components
- Decision-making criteria for the selection of components
- Online help in English, French, German, Italian, Chinese and Japanese

#### System requirements

- PG or PC with Pentium III min. 800 MHz (recommended > 1 GHz)
- 512 MB RAM (1 GB RAM recommended)
- At least 4.1 GB of free hard disk space
- An additional 100 MB of free hard disk space on Windows system drive
- Screen resolution 1024 × 768 pixels (1280 × 1024 pixels recommended)
- Operating system:
  - Windows 7 Professional (32/64-bit)
  - Windows 7 Enterprise (32/64-bit)
  - Windows 7 Ultimate (32/64-bit)
  - Windows 7 Home (32/64-bit)
  - Windows 8.1 Professional (32/64-bit)
  - Windows 8.1 Enterprise (32/64-bit)
  - Windows 10
- Microsoft Internet Explorer V5.5 SP2 and higher

#### Selection and ordering data

Description	Article No.
<b>SIZER for Siemens Drives engineering tool</b> on DVD-ROM	<b>6SL3070-0AA00-0AG0</b>
English, French, German, Italian	

#### More information

The SIZER for Siemens Drives engineering tool is available free on the Internet at [www.siemens.com/sizer](http://www.siemens.com/sizer)

## SINAMICS web server for SINAMICS G120X via SINAMICS G120 Smart Access

**Overview**

*Web server for efficient commissioning, diagnostics and maintenance*

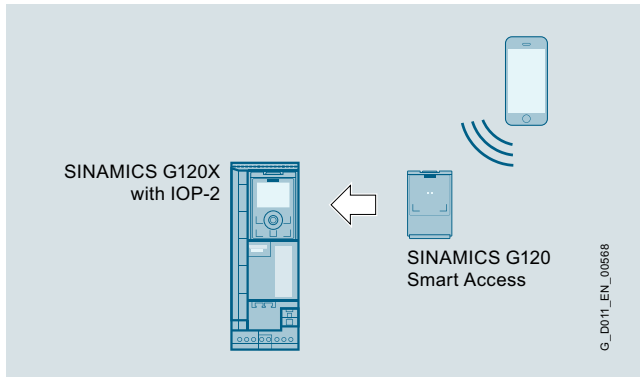

SINAMICS G120X with IOP-2 and SINAMICS G120 Smart Access

Thanks to the optionally available SINAMICS G120 Smart Access, the SINAMICS G210X drive system offers a web server for efficient commissioning, diagnostics and maintenance options. The web server provides access to a multi-faceted range of new options for parameter assignment and drive diagnostics for laptops, tablets and smartphones, including:

- Simple and fast commissioning
- Drive traversing via the control panel
- Downloading/uploading a configuration
- Providing a status overview of the drive
- Evaluating warnings and fault messages
- Monitoring and adapting parameter settings

**Benefits****Simple and fast commissioning**

- No installation of additional commissioning software
- Standard pages for limit values and settings
- Comprehensive fault diagnosis

**Direct language selection**

- English, German, French, Italian, Spanish, Chinese

**Accessibility**

- Free choice of terminal devices as the web server works with all common web browsers, such as iOS, Android, Windows, Linux and Mac OS

**Diagnostic functions**

- Quick overview of the current configuration and the state of the drive
- Understandable diagnostic information and messages, including the causes of issues and possible remedies, are displayed in plain text in multiple languages

**Freely configurable parameter lists**

- Monitoring parameters for diagnostic purposes, for example for operating personnel
- Adjustment of the parameter lists using filters, parameter groups and the configuration of personal lists

**Access security**

- Protection against unauthorized access to the drive information

**Application**

The web server is ideal for applications in which special commissioning software or version dependencies are not desired. Easy commissioning, diagnostics and maintenance are possible locally, provided appropriate security measures are applied.

## Engineering tools

### Notes

3

## Services and documentation



4/2	<b>Partner · Industry Mall and Interactive Catalog CA 01</b>
4/3	<b>Information and Download Center</b>
4/4	<b>Industry Services</b>
4/5	Industry Services – Portfolio overview
4/6	Online Support
4/7	<b>Training</b>
4/7	SITRAIN – Training for Industry
4/8	Training courses for SINAMICS low-voltage converters
4/9	SINAMICS G120X training case
4/10	<b>Control cabinets</b>
4/12	<b>Repair service contract RSC</b>
4/14	Types of contract for production machines
4/15	<b>Applications</b>
4/16	<b>Spare parts services</b>
4/16	Spare parts services during the lifecycle
4/16	Delivery of spare parts
4/17	Delivery as exchange product
4/17	Repair
4/18	Product upgrade service
4/18	General overhaul
4/19	Function check
4/19	Return of diagnostic parts
4/20	Stock reduction in spare parts store
4/20	Extended spare part availability
4/21	<b>Spares on Web</b>
4/22	<b>Product Partner – Drives Options</b>
4/23	<b>mySupport documentation</b>
4/24	<b>Documentation</b>
4/24	General documentation
4/25	SINAMICS G120X documentation

## Services and documentation

### Partner · Industry Mall and Interactive Catalog CA 01

#### Partner at Siemens

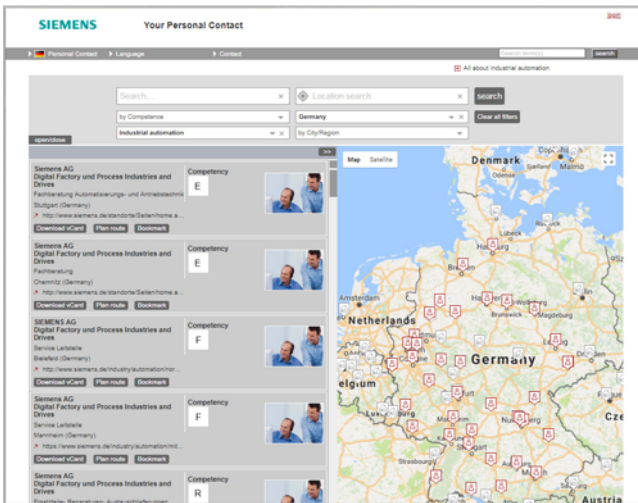

At your service locally, around the globe for consulting, sales, training, service, support, spare parts on the entire portfolio of Digital Factory and Process Industries and Drives.

Your partner can be found in our Personal Contacts Database at: [www.siemens.com/automation-contact](http://www.siemens.com/automation-contact)

You start by selecting

- the required competence,
  - products and branches,
  - a country and a city
- or by a
- location search or free text search.

#### Easy product selection and ordering in the Industry Mall and with the Interactive Catalog CA 01

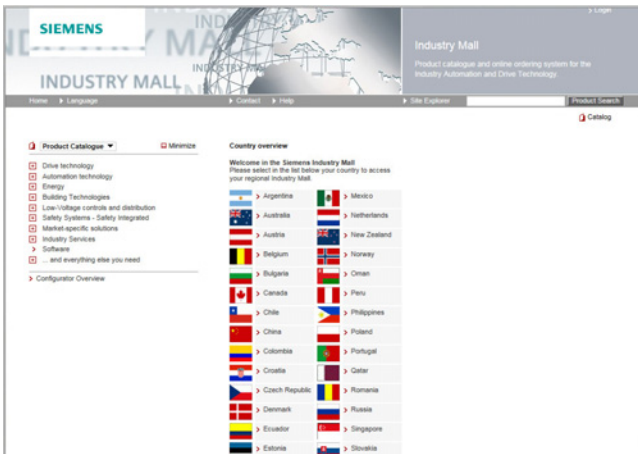

#### Industry Mall

The Industry Mall is a Siemens Internet ordering platform. Here you have a clear and informative online access to a huge range of products.

Powerful search functions make it easy to select the required products. Configurators enable you to configure complex product and system components quickly and easily. CAx data types are also provided here.

Data transfer allows the whole procedure, from selection through ordering to tracking and tracing, to be carried out online. Availability checks, customer-specific discounts and bid creation are also possible.

[www.siemens.com/industrymall](http://www.siemens.com/industrymall)



#### Interactive Catalog CA 01 - Products for Automation and Drives

The Interactive Catalog CA 01 combined with the Siemens Industry Mall unites the benefits of offline and online media in one application – the performance of an offline catalog with the availability of manifold and up-to-date information on the Internet.

Select products and assemble orders with the CA 01, determine the availability of the selected products and track & trace via the Industry Mall.

More information and download: [www.siemens.com/automation/ca01](http://www.siemens.com/automation/ca01)



### Downloading catalogs

The screenshot displays the Siemens Information and Download Center interface. At the top, there is a navigation bar with the Siemens logo and links for 'Language' and 'Contact'. Below this, the main content area is titled 'Information and Download Center'. It features a search bar, a 'Text Size' selector, and social media sharing options. A filter dialog is visible, showing 'Promotion packages (12)' and a list of items. The main list of results includes two catalog entries:

- Catalog D 11 - 2015 (13 MB)**  
Order number: 6ES7045511-A10-A6-7000  
SINAMICS G130 Drive Converter Chassis Units  
SINAMICS G150 Drive Converter Cabinet Units
- Catalog D 12 - 2017 with dimension drawings**  
Order number: keine (Bestellnummer vorhanden)  
Medium voltage drives  
SINAMICS GM150  
SINAMICS SM150  
with dimension drawings

On the right side, there is a 'Products & Services' filter menu with the following categories:

- Building Technologies (2)
- Drive technology (294)
- Energy (11)
- Industrial automation (922)
- Low-voltage controls and distribution (32)
- Safety systems - Safety Integrated (31)
- Services (8)
- Software (1)

Below this, there is an 'All about Products & Services' section with links for:

- Press releases
- Catalog and ordering system online
- Technical info
- Support
- Service offer

In the Information and Download Center you can download catalogs and brochures in PDF format without having to register. The filter dialog makes it possible to carry out targeted searches.

[www.siemens.com/industry/infocenter](http://www.siemens.com/industry/infocenter)

## Services and documentation

### Industry Services

#### Overview

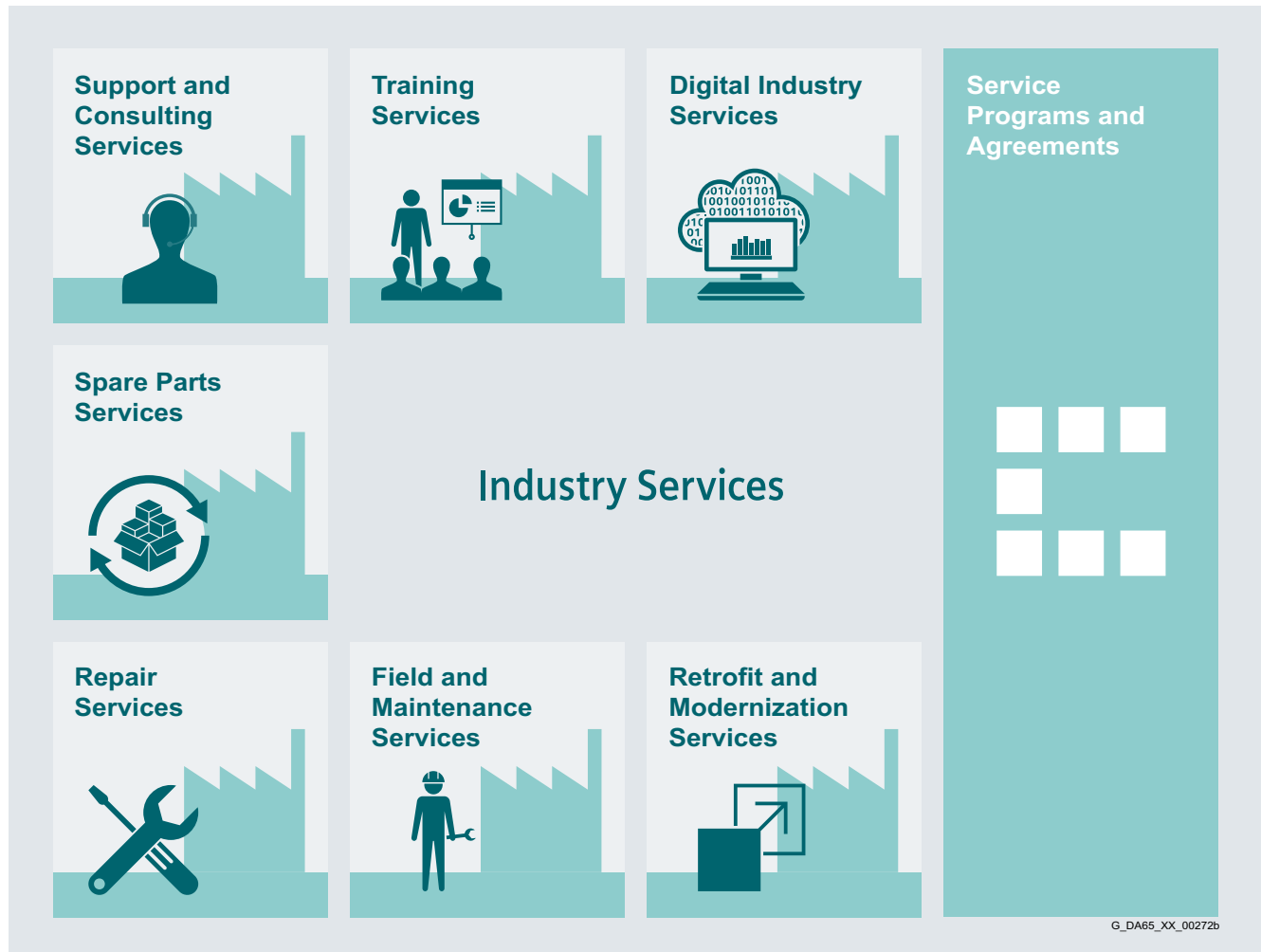

4

#### Keep your business running and shaping your digital future – with Industry Services

Optimizing the productivity of your equipment and operations can be a challenge, especially with constantly changing market conditions. Working with our service experts makes it easier. We understand your industry's unique processes and provide the services needed so that you can better achieve your business goals.

You can count on us to maximize your uptime and minimize your downtime, increasing your operations' productivity and reliability. When your operations have to be changed quickly to meet a new demand or business opportunity, our services give you the flexibility to adapt. Of course, we take care that your production is protected against cyber threats. We assist in keeping your operations as energy and resource efficient as possible and reducing your total cost of ownership. As a trendsetter, we ensure that you can capitalize on the opportunities of digitalization and by applying data analytics to enhance decision making: You can be sure that your plant reaches its full potential and retains this over the longer lifespan.

You can rely on our highly dedicated team of engineers, technicians and specialists to deliver the services you need – safely, professionally and in compliance with all regulations. We are there for you, where you need us, when you need us.

[www.siemens.com/industrieservices](http://www.siemens.com/industrieservices)

### Overview



Digital Industry Services

#### Digital Industry Services

Digital Industry Services make your industrial processes transparent to gain improvements in productivity, asset availability, and energy efficiency.

Production data is generated, filtered and translated with intelligent analytics to enhance decision-making.

This is done whilst taking data security into consideration and with continuous protection against cyber-attack threats.

<https://www.siemens.com/global/en/home/products/services/industry/digital-services.html>

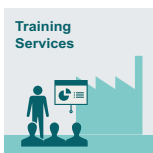

Training Services

#### Training Services

From the basics and advanced to specialist skills, SITRAIN courses provide expertise right from the manufacturer – and encompass the entire spectrum of Siemens products and systems for the industry.

Worldwide, SITRAIN courses are available wherever you need a training course in more than 170 locations in over 60 countries.

<https://support.industry.siemens.com/cs/ww/en/sc/2226>

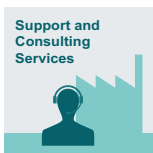

Support and Consulting Services

#### Support and Consulting Services

**Industry Online Support** site for comprehensive information, application examples, FAQs and support requests.

**Technical and Engineering Support** for advice and answers for all inquiries about functionality, handling, and fault clearance. The Service Card as prepaid support for value added services such as Priority Call Back or Extended Support offers the clear advantage of quick and easy purchasing.

**Information & Consulting Services**, e.g. SIMATIC System Audit; clarity about the state and service capability of your automation system or Lifecycle Information Services; transparency on the lifecycle of the products in your plants.

<https://support.industry.siemens.com/cs/ww/en/sc/2235>



Spare Parts Services

#### Spare Parts

Spare Parts Services are available worldwide for smooth and fast supply of spare parts – and thus optimal plant availability. Genuine spare parts are available for up to ten years. Logistic experts take care of procurement, transport, custom clearance, storage and order management.

Reliable logistics processes ensure that components reach their destination as needed.

Since not all spare parts can be kept in stock at all times, Siemens offers a preventive measure for spare parts provisioning on the customer's premises with optimized **Spare Parts Packages** for individual products, custom-assembled drive components and entire integrated drive trains – including risk consulting.

**Asset Optimization Services** help you design a strategy for parts supply where your investment and carrying costs are reduced and the risk of obsolescence is avoided.

<https://support.industry.siemens.com/cs/ww/en/sc/2110>



Repair Services

#### Repair Services

Repair Services are offered on-site and in regional repair centers for fast restoration of faulty devices' functionality.

Also available are extended repair services, which include additional diagnostic and repair measures, as well as emergency services.

<https://support.industry.siemens.com/cs/ww/en/sc/2154>

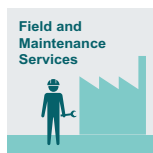

Field and Maintenance Services

#### Field and Maintenance Services

Siemens specialists are available globally to provide expert field and maintenance services, including commissioning, functional testing, preventive maintenance and fault clearance.

All services can be included in customized service agreements with defined reaction times or fixed maintenance intervals.

<https://support.industry.siemens.com/cs/ww/en/sc/2265>



Retrofit and Modernization Services

#### Retrofit and Modernization Services

Provide a cost-effective solution for the expansion of entire plants, optimization of systems or upgrading existing products to the latest technology and software, e.g. migration services for automation systems.

Service experts support projects from planning through commissioning and, if desired over the entire extended lifespan, e.g. Retrofit for Integrated Drive Systems for an extended lifetime of your machines and plants.

<https://support.industry.siemens.com/cs/ww/en/sc/2286>



Service Programs and Agreements

#### Service Programs and Agreements

A technical Service Program or Agreement enables you to easily bundle a wide range of services into a single annual or multi-year agreement.

You pick the services you need to match your unique requirements or fill gaps in your organization's maintenance capabilities.

Programs and agreements can be customized as KPI-based and/or performance-based contracts.

<https://support.industry.siemens.com/cs/ww/en/sc/2275>

## Services and documentation

Industry Services

### Online Support

#### Overview

Online Support – fast, intuitive, whenever you want, wherever you need

Web

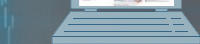

[support.industry.siemens.com](http://support.industry.siemens.com)

App

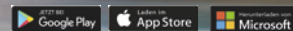

Scan the QR code for information on our Online Support app.



#### FAQ / Application examples

Information about industrial products, programming and configuration as well as application examples



#### Technical information

Videos, documentation, manuals, updates, product notes, compatibility tool, certificates, planning data such as dimensional drawings, product data, 3D models



#### Forum

Exchange information and experience with other users and experts

## Online Support for Siemens Products for Industry

Siemens Industry and Online Support with some 1.7 million visitors per month is one of the most popular web services provided by Siemens. It is the central access point for comprehensive technical know-how about products, systems and services for automation and drives applications as well as for process industries.

In connection with the challenges and opportunities related to digitalization you can look forward to continued support with innovative offerings.

### Overview



#### **Your benefit from practical training directly from the manufacturer**

SITRAIN – Training for Industry – provides you with comprehensive support in solving your tasks.

Training directly from the manufacturer enables you to make correct decisions with confidence.

#### **Increased profits and lower costs:**

- Shorter times for commissioning, maintenance and servicing
- Optimized production operations
- Reliable configuration and commissioning
- Shortened startup times, reduced downtimes, and faster troubleshooting
- Exclude expensive faulty planning right from the start.
- Flexible plant adaptation to market requirements
- Compliance with quality standards in production
- Increased employee satisfaction and motivation
- Shorter familiarization times following changes in technology and staff

#### **Contact**

Visit our site on the Internet at:  
[www.siemens.com/sitrain](http://www.siemens.com/sitrain)

or let us advise you personally.

**SITRAIN – Training for Industry**  
**SITRAIN Customer Support Germany:**

Tel.: +49 911 895-7575

Fax: +49 911 895-7576

Email: [info@sitrain.com](mailto:info@sitrain.com)

#### **Your benefits with SITRAIN – Training for Industry**

##### Certified top trainers

Our trainers are skilled specialists with practical experience. Course developers have close contact with product development, and pass on their knowledge to the trainers and then to you.

##### Practical application with practice

Practice, practice, practice! We have designed the trainings with an emphasis on practical exercises. They take up to half of the course time in our trainings. You can therefore implement your new knowledge in practice even faster.

##### 300 courses in more than 60 countries

We offer a total of about 300 classroom-based courses. You can find us at more than 50 locations in Germany, and in 62 countries worldwide. You can find which course is offered at which location at:

[www.siemens.com/sitrain](http://www.siemens.com/sitrain)

##### Skills development

Do you want to develop skills and fill in gaps in your knowledge? Our solution: We will provide a program tailored exactly to your personal requirements. After an individual requirements analysis, we will train you in our training centers near you or directly at your offices. You will practice on the most modern training equipment with special exercise units. The individual training courses are optimally matched to each other and help with the continuous development of knowledge and skills. After finishing a training module, the follow-up measures make success certain, as well as the refreshment and deepening of the knowledge gained.

## Services and documentation

### Training

#### Training courses for SINAMICS low-voltage converters

##### Overview

##### Training courses for SINAMICS drive system

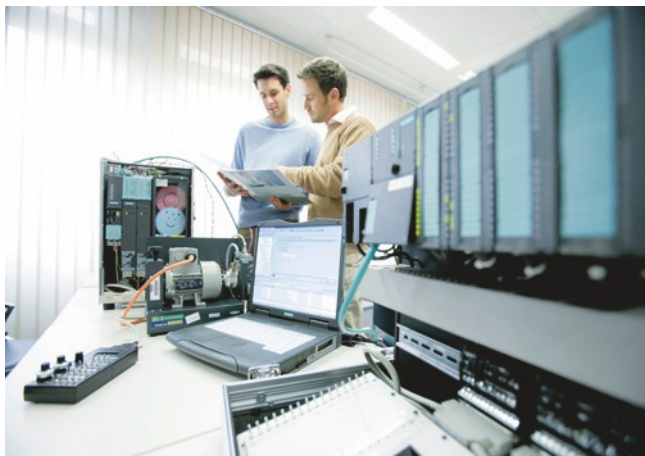

This provides an overview of the training courses available for the SINAMICS drive system.

The courses are modular in design and are directed at a variety of target groups as well as individual customer requirements.

The system overview will acquaint decision-makers and sales personnel with the system very quickly.

The engineering course provides all the information you need to configure the drive system.

The courses dedicated to diagnostics and servicing, parameterization and commissioning, communication as well as extended functions such as Safety Integrated are sure to provide all the technical knowledge service engineers will need.

All courses contain as many practical exercises as possible to enable intensive and direct training on the drive system and with the tools in small groups.

Please also take note of the training options available for SIMOTICS motors. You will find more information about course contents and dates in Catalog ITC and on the Internet.

Title (all courses are available in English and German)	Target group			Duration	Order code
	Planners, decision-makers, sales personnel	Commissioning engineers, configuring engineers	Service personnel, maintenance technicians		
<b>Courses Fundamentals and overview</b>					
SINAMICS and SIMOTICS – Basics of drive technology	✓	✓	✓	5 days	DR-GAT
SINAMICS and SIMOTICS – System overview	✓	–	–	3 days	DR-SYS
SINAMICS System Overview	✓	–	–	2 days	DR-SN-UEB
<b>Courses SINAMICS S120</b>					
Planning and engineering	✓	–	–	5 days	DR-S12-PL
Parameterizing and commissioning	–	✓	–	5 days	DR-S12-PM
Parameterization Advanced Course	–	✓	–	5 days	DR-S12-PA
Parameterizing and optimizing	–	✓	–	3 days	DR-S12-OPT
Parameterizing Safety Integrated	–	✓	–	4 days	DR-S12-SAF
Diagnostics and service	–	–	✓	5 days	DR-S12-DG
Diagnostics at chassis and cabinet units	–	✓	✓	3 days	DR-S12-CHA
Diagnostics PROFINET and PROFIBUS	–	✓	✓	3 days	DR-S12-NET
<b>Courses SINAMICS G120</b>					
Planning and engineering	✓	–	–	2 days	DR-G12-PL
Parameterizing and commissioning	–	✓	–	2 days	DR-G12-PM
Parameterization Advanced Course	–	✓	–	3 days	DR-G12-PA
Parameterizing Safety Integrated	–	✓	–	2 days	DR-G12-SAF
<b>Courses SINAMICS G120X</b>					
Parameterizing and commissioning	–	✓	✓	1 day	DR-G12X-PM
<b>Courses SINAMICS G130/G150/G180/S150</b>					
DYNAVERT – commissioning and diagnostics	–	✓	✓	2 days	DR-DYNA
SINAMICS G150/G130/S150 – diagnostics and service	–	✓	✓	5 days	DR-G15-DG
SINAMICS G180 – diagnostics and service	–	–	✓	2.5 days	DR-G18-DG

## Overview



SINAMICS G120X training case

The SINAMICS G120X training case is a convincing demonstration system thanks to its compact design. It is suitable for direct customer presentations as well as for tests in technical departments. It enables the functions of SINAMICS G120X to be demonstrated and tested quickly and easily.

It contains the following components:

- SINAMICS G120X frequency converter, PROFINET, EtherNet/IP, 0.75 kW
- Operator panels IOP-2 and BOP-2
- SINAMICS G120 Smart Access
- SIMOTICS GP asynchronous (induction) motor

The SINAMICS G120X training case is supplied as a trolley with a hood.

## Technical specifications

<b>SINAMICS G120X training case</b>	
	6AG1067-2AA00-0AC1
<b>Supply voltage</b>	230 V 1 AC
<b>Dimensions</b>	
• Width	290 mm (11.42 in)
• Height	470 mm (18.50 in)
• Depth	300 mm (11.81 in)
<b>Weight, approx.</b>	16.9 kg (37.26 lb)

## Selection and ordering data

Description	Article No.
<b>SINAMICS G120X training case</b>	<b>6AG1067-2AA00-0AC1</b>

## Services and documentation

### Control cabinets

#### Overview

##### *Complete equipment for machine tools and production systems*

Our supplied range of products and services also includes complete equipment for machine tools and production systems with all services in the process chain from consulting through to after-sales service.

We support you in the areas of engineering, production and logistics.

##### *Engineering support*

Siemens supports you with advice on design in accordance with standards and concepts for drive systems, control, operation and safety.

Our engineers configure for you in EPLAN P8 and other commonly used CAD systems, execute projects designed to cost and adapt your documents where necessary to UL or new systems.

Our Technical Competence Center Cabinets in Chemnitz supports you with selecting and optimizing the suitable control cabinet air-conditioning system. Apart from calculation and simulation, we also use instrumentation testing in our heat laboratory with load simulation.

We also offer the following services:

- Vibration measurements and control cabinet certification in the field
- Measurement of conducted interference voltages in our laboratory



Cabinet engineering

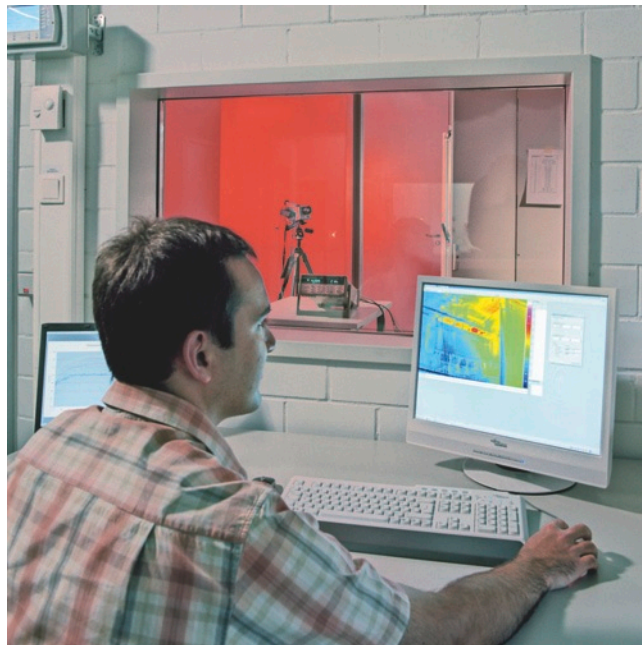

Testing in the heat laboratory

##### *Production at a high level of quality*

Complete equipment is manufactured at a high industrial level. This means:

- Examining consistency of the order documentation
- Checking for adherence to current regulations
- Collision check in 3D layout, taking into account the free space required thermally and electrically
- Automatic preparation of enclosures, cables and cable bundles
- Automated inspection and shipment free of faults
- Documentation and traceability
- Declaration of conformity regarding the Low-Voltage Directive and manufacturer's declaration on machinery directive
- UL label on request

##### *Superior logistics*

Everything from a single source offers you the following advantages:

- Cost savings for procurement, stockkeeping, financing
- Reduction in throughput times
- Just-in-time delivery

##### *Individual support and maximum flexibility*

Our technical consultants for complete equipment support customers and sales departments in the various regions. Our control cabinet customers are supported in the Systems Engineering Plant Chemnitz (WKC) by ordering centers and production teams that are permanently assigned to customers.

Distance does not present a problem; we also use web cams for consulting our customers.



**Overview** (continued)

**Worldwide repair service**

Customer-specific logistics models, flexible production capacity and production areas as well as change management in all process phases ensure maximum flexibility.

**Customized supplementary products**

As part of its complete equipment program, Siemens also offers the development and construction of customized supplementary products, e.g. special operator panels and power supply systems.

**Liability for defects**

Of course we accept the same liability for defects for our complete equipment as for our SINUMERIK and SINAMICS products.

Furthermore, you can use our worldwide repair service anywhere and at any time.

**Your benefits**

One partner, one quotation, one order, one delivery, one invoice, and one contact partner for liability of defects.

For series production or individual items, Siemens is your competent partner for complete equipment.

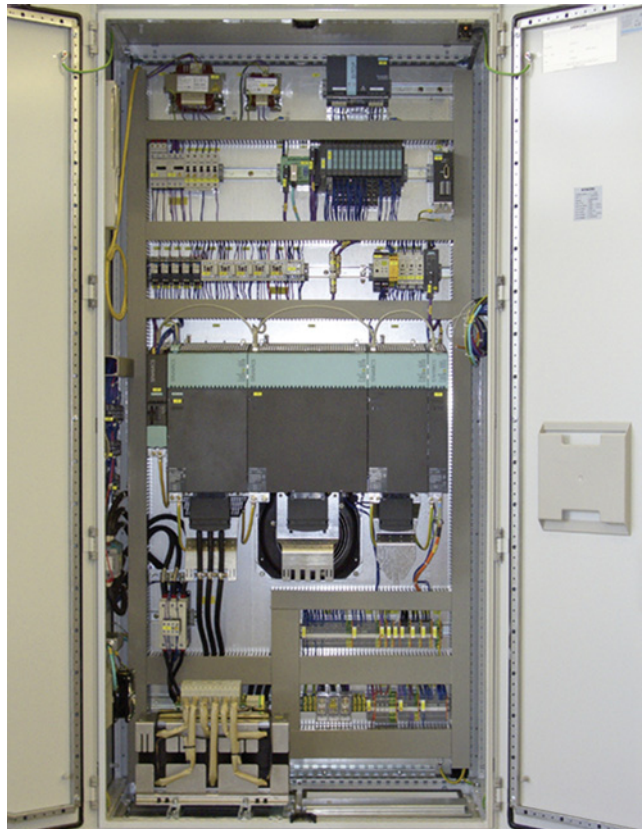

Control cabinet with SINAMICS S120 in booksize format

## Services and documentation

### Repair service contract RSC

#### Overview

##### *RSC description of performance*

Siemens provides for the machine manufacturer and dealer (in the following referred to as the "Customer") at the installation site of the machine the services specified below under Scope of services for components from Siemens DF & PD contained in the parts list of the RSC Certificate.

The RSC is ordered by the Customer who states the required article numbers that can be obtained from the Siemens sales partners or found in catalogs and the Industry Mall. The Customer receives from Siemens a certificate of delivery, which thus signifies the conclusion of the RSC.

After the Customer has provided the final destination notification, Siemens sends the Customer an RSC Certificate detailing the place of performance and the service period.

The services to be provided by Siemens are requested via a service order from the Customer. The service order must be submitted within the service period of the RSC.

##### *Place of performance*

The specified service is provided at the installation site of the machine (hereinafter referred to as "on-site"). This corresponds to the country of the end customer and the latter's full address, as specified in the final destination notification. Services covered by this RSC shall only be provided in those countries named in the RSC country list.

##### *Scope of services*

The following services shall be provided:

- Provision of service personnel  
Siemens provides qualified personnel for the purpose of fault diagnostics and/or fault correction. The services are provided during the normal regional working hours in the country of installation.
- On-site fault diagnostics  
Fault diagnostics applies to components from Siemens DF & PD as stated in the parts list in the RSC Certificate.
- Fault correction on-site  
Fault correction is carried out by repairing and/or replacing defective components from Siemens DF & PD.
- Documentation of the fault correction  
A service report is prepared on-site in the language of the end customer and shall be signed by the end customer. A copy of the report remains with the end customer.

##### *Contract periods/service period*

The RSC is offered for the period of liability (warranty period) of the Siemens customers to their end customers. Different RSC periods permit various market requirements to be addressed.

The service period of the RSC begins on the date notified to Siemens in the final destination notification when commissioning has been completed at the end customer's site and ends on expiry of the selected RSC term. The beginning and end of the performance period are stated in the RSC Certificate <sup>1)</sup>.

##### *RSC Certificate*

The Customer is provided with an RSC Certificate once the final destination notification has been handed over. This certificate shall contain the contract number and essential contract data such as machine number, machine type, parts list, beginning and end of the service period and the place of performance (address for the provision of services).

##### *Service exclusions*

The following is not included in the services:

- Complete motor spindles
- Services cannot be provided for wearing parts after the first 12 months of the contract period.
- Machine commissioning or optimization
- Masonry work, metalwork, breaking work and other non-electrical work
- Fault diagnostics and fault correction relating to faults that have occurred as a result of:
  - Non-compliance with the Siemens engineering and user guidelines, e.g. incorrect installation or grounding and incorrect operation or other improper treatment
  - Function-critical contamination, e.g. oil, conductive materials, rust
  - Mechanical damage
  - External electrical influences, for example, effects of overvoltage, non-reactor-protected power factor correction systems and/or line harmonics
  - Wanton destruction
  - Force majeure

<sup>1)</sup> For example, in the case of an RSC with 12 months contract period, maximum of 24 months from the transfer of risk (delivery of the components).

#### Overview (continued)

##### Country list

A repair service is offered for the following countries:

Continent	Country/region
<b>Country group 1</b>	
Americas	Mexico, USA
Asia	China, India, Japan, South Korea, Taiwan, Thailand
Australia	Australia
Europe	Andorra, Austria, Belgium, Czech Republic, Denmark, Finland, France, Germany, Great Britain, Hungary, Italy, Liechtenstein, Luxembourg, Monaco, the Netherlands, Poland, Portugal, Rumania, Slovak Republic, Spain, Sweden, Switzerland, Turkey
<b>Country group 2</b>	
Africa	South Africa
Americas	Brazil, Canada
Asia	Indonesia, Israel, Malaysia, Singapore
Australia	New Zealand
Europe	Bosnia-Herzegovina, Bulgaria, Croatia, Estonia, Ireland, Latvia, Lithuania, Norway, Slovenia
<b>Country group 3</b>	
Africa	Egypt
Americas	Argentina, Chile, Columbia, Ecuador, Peru, Venezuela
Asia	Bahrain, Hong Kong, Kuwait, Oman, Qatar, Saudi Arabia, United Arab Emirates (Dubai), Vietnam
Europe	Belarus, Greece, Malta, Russia, Serbia and Montenegro, Ukraine

**Countries not listed, for customers with framework contracts only.**

##### Response time

The following response times apply in general whenever services are provided under the RSC in the event of a machine standstill:

Country groups	
CG 1	Next working day
CG 2	Within two working days
CG 3	Depending on country-specific conditions
Countries not listed	Depending on country-specific conditions, only for customers with framework contracts for the price of the individual contract.

The response time is defined as the time between Siemens receiving the service order, technically clarified in advance by the Customer, and the Siemens service personnel commencing his travel to the place of performance or until troubleshooting commences using teleservice. The response times given apply to technically clarified service orders within the normal working hours of the region (e.g. Monday to Friday 8:00 to 17:00) excluding public holidays.

##### Spare parts

Spare parts are provided from our central spare parts warehouse or from regional spare parts warehouses using our worldwide spare parts logistics infrastructure. All of the essential spare parts are stocked in our central spare parts stores. Regional spare parts warehouses are adapted to include the components specified in the final destination certificate<sup>1)</sup>.

The following components are not defined as spare parts:

- Motors: They are repaired at an authorized repair workshop. For selected motors, Siemens in Germany stocks components for express delivery. These motors can be manufactured and delivered within a few working days. You can obtain the current list from your Siemens sales partner.
- Cables: The delivery times known to you usually apply.
- Special or customer-specific modules and components not available from Siemens as spare parts.

The RSC shall only be processed in accordance with the terms and conditions applying to repair service contracts (RSC).

[www.siemens.com/automation/rscagb](http://www.siemens.com/automation/rscagb)

##### Benefits

- Protection against unknown costs for a fixed price
- RSC can be synchronized with the machine warranty period
- Planning certainty and calculable costs
- Easier processing in service cases
- High machine availability thanks to a fast response to machine faults (contract priority)
- Reduced downtimes thanks to stored product, final destination and contract information
- RSC can be ordered for machine deliveries to numerous countries
- Worldwide service infrastructure with experienced service staff

<sup>1)</sup> Since the export of standard versions (components/system) is subject to a time-consuming official approval procedure, which applies in equal measure to the supply of such components for the purpose of servicing and spare parts supply, we offer **an export version** for individual components. This has usually less options than the standard version of the component and is not subject to an export authorization. Please note the **information about export**.

## Services and documentation

### Repair service contract RSC

#### Types of contract for production machines

#### Overview



#### Data handling

To improve the service availability, Siemens DF & PD offers users the opportunity to register machines online and to save what is known as a identSNAPSHOT file. In addition to the component list and the software requirements of machines, this also includes information on machine manufacturers, and where relevant, dealers and end customers.

To simplify data handling, information about the final destination certificate can be saved using the XML function of identSNAPSHOT and transferred to Siemens using an online registration. This data can also be kept with the machine as data backup.

[www.siemens.com/identsnapshot](http://www.siemens.com/identsnapshot)

#### Selection and ordering data

Description	Article No.
<b>Repair service contract RSC</b>	
For Siemens DF & PD components on production machines for countries in country groups 1 to 3	
• 12 month contract period <sup>1)</sup>	<b>6FC8507-0RX12-■■■0</b>
• 24 month contract period <sup>2)</sup>	<b>6FC8507-0RX24-■■■0</b>
Equipment value in €	↑
0.–	0
100000.–	1
200000.–	2
300000.–	3
400000.–	4
500000.–	5
600000.–	6
700000.–	7
800000.–	8
900000.–	9
	↑
0.–	A
10000.–	B
20000.–	C
30000.–	D
40000.–	E
50000.–	F
60000.–	G
70000.–	H
80000.–	J
90000.–	K
	↑
0.–	A
1000.–	B
2000.–	C
3000.–	D
4000.–	E
5000.–	F
6000.–	G
7000.–	H
8000.–	J
9000.–	K

Ordering example:

Contract period of 12 months and equipment value €96000  
6FC8507-0RX12-0KG0

<sup>1)</sup> Max. 24 months from the transfer of risk (delivery of components).

<sup>2)</sup> Max. 36 months from the transfer of risk (delivery of components).

### Overview



Our understanding of an application is the customer-specific solution of an automation task based on standard hardware and software components. In this respect, industry knowledge and technological expertise are just as important as expert knowledge about how our products and systems work. We are setting ourselves this challenge with more than 280 application engineers in 20 countries.

#### Application centers

We currently have application centers in:

- Germany: Head Office in Erlangen and in other German regions, e.g. in Munich, Nuremberg, Stuttgart, Mannheim, Frankfurt, Chemnitz, Cologne, Bielefeld, Bremen, Hanover, Hamburg
- Belgium: Brussels
- Brazil: Sao Paulo
- China: Beijing and 12 regions
- Denmark: Ballerup
- France: Paris
- Great Britain: Manchester
- India: Mumbai
- Italy: Bologna, Milan
- Japan: Tokyo, Osaka
- The Netherlands: The Hague
- Austria: Vienna
- Poland: Warsaw
- Sweden: Göteborg
- Switzerland: Zurich, Lausanne
- Spain: Madrid
- South Korea: Seoul
- Taiwan: Taipei
- Turkey: Istanbul
- USA: Atlanta

These application centers specialize in the use of SIMATIC/SIMOTION/SINAMICS. You therefore can rely on automation and drive specialists for implementing successful applications. By involving your personnel at an early stage in the process, we can provide a solid basis for rapid knowledge transfer, maintenance and further development of your automation solution.

#### Advice on applications and implementation

We offer a variety of consultation services to help you find the optimum solution for the SIMATIC/SIMOTION/SINAMICS application you want to implement:

The quotation phase includes

- clarification of technical questions,
- discussion of machine concepts and customer-specific solutions,
- selection of suitable technology and
- suggestions for implementation.

A technical feasibility study is also performed at the outset. In this way, difficult points of the application can be identified and solved early on. We can also configure and implement your application as a complete solution from a single source.

A large number of proven standard applications are available for use during the implementation phase. This saves engineering costs.

The system can be commissioned by experienced, competent personnel, if required. This saves time and trouble.

If servicing is required, we can support you on site or remotely. For further information about servicing, please see the section "Industry Services".

#### On-site application training

Training for the implemented applications can also be organized and carried out on site. This training for machine manufacturers and their customers does not deal with individual products, but the entire hardware and software system (for example, automation, drives and visualization).

From an initial concept to successful installation and commissioning: We provide complete support for SIMATIC/SIMOTION/SINAMICS! Contact your Siemens representative.

You can find further information at [www.siemens.com/machinebuilding](http://www.siemens.com/machinebuilding)

## Services and documentation

### Spare parts services

#### Spare parts services during the lifecycle

##### Overview

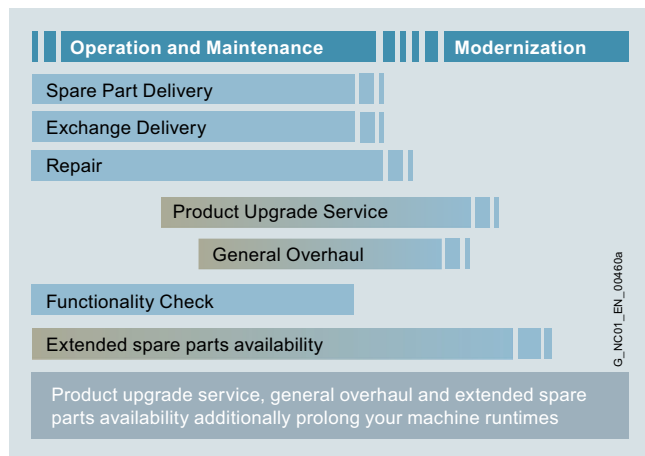

Spare parts services during the lifecycle

Siemens also provides constant support to customers after delivery of the machines or plant. This includes spare parts, repairs, as well as other supplementary services, and has a positive effect on machine operating times, inventories and costs.

When customers purchase a high-quality machine or plant, they intend to use it as intensively as possible, preferably for three shifts a day over many years. Under such circumstances, it is normal for parts to fail eventually. It is essential to replace the part as quickly as possible, because every hour of a plant stoppage costs money. To satisfy the multi-faceted requirements in the different areas, we have created comprehensive spare parts services.

##### Overview (continued)

You can sign up for the spare parts service that suits your requirements perfectly:

- Delivery of spare parts
- Delivery as exchange product
- Repair
- Product upgrade service
- General overhaul
- Function check
- Return of diagnostic parts
- Stock reduction of your spare parts store
- Extended spare parts availability

##### Benefits

- Optimum price/performance ratio and top quality
- Lifecycle management over the complete lifecycle
- Outstanding quality and availability of your machines and plant using Siemens original spare parts
- Global network and optimized logistics chains – 24 hours a day, 365 days a year
- Additional services from Siemens

##### More information

More information is available on the Internet at:

[www.siemens.com/motioncontrol/spareparts](http://www.siemens.com/motioncontrol/spareparts)

For further information, please approach your contact at your local Siemens office.

Contact information is available on the Internet at:

[www.siemens.com/automation-contact](http://www.siemens.com/automation-contact)

#### Delivery of spare parts

##### Overview

In every industry worldwide, plants and systems are required to operate with constantly increasing reliability. Lack of a specific spare part can result in considerable costs. We will provide you with the support you need to prevent a standstill from occurring in the first place: with a worldwide network and optimum logistics chains.

Ordering mode	Logistics service	Note
Standard	Cost-optimized: Contracted shipping company	Delivery within the normal national delivery times through the contracted shipping company
Plant stoppage	Time-optimized: Express, courier, collection	You choose the shortest possible delivery time for your own benefit: <ul style="list-style-type: none"> <li>• Delivery by means of collection or courier service</li> <li>• Delivery by express service</li> </ul>
Emergency service	Special logistics: Courier	You can also order the spare parts from us outside normal working hours, as well as on weekends or national holidays round-the-clock. <ul style="list-style-type: none"> <li>• Your delivery will arrive by courier</li> </ul>

##### Benefits

- New liability for defects for the spare part
- Long-term spare parts availability
- Optimum system compatibility

#### Overview

In addition to the simple delivery of spare parts, with many products, we also offer you the option of an exchange. This has the advantage that you not only receive the spare part quickly, but are able to return the defective device to us for a credit. You therefore receive our spare part at the lower exchange price.

A credit will be awarded on condition that the repair code indicates that repurchasing is admissible, a replacement is obtained from the spare parts store, and that the returned product is repairable.

The ordering mode and logistics service determine the delivery of spare parts:

Ordering mode	Logistics service	Note
Standard	Cost-optimized: Contracted shipping company	Delivery within the normal national delivery times through the contracted shipping company
Plant stoppage	Time-optimized: Express, courier, collection	You choose the shortest possible delivery time for your own benefit: <ul style="list-style-type: none"> <li>• Delivery by means of collection or courier service</li> <li>• Delivery by express service</li> </ul>
Emergency service	Special logistics: Courier	You can also order the spare parts from us outside normal working hours, as well as on weekends or national holidays round-the-clock. <ul style="list-style-type: none"> <li>• Your delivery will arrive by courier</li> </ul>

#### Overview (continued)

##### Return

For returns, we require the following information:

- Reason for return
- If defective: detailed description of the fault
- Machine number
- Machine/system manufacturer
- End customer

We will then be able to provide you with additional information in the repair report/inspection report regarding the diagnosis/inspection as well as information about the completed repair.

#### Benefits

- Savings thanks to the option of returning defective parts
- A spare part is available immediately in the event of failure
- New liability for defects for the spare part
- Long-term spare parts availability
- Optimum system compatibility

### Repair

#### Overview

Downtimes cause problems in the plant as well as unnecessary costs. We can help you to reduce both to a minimum – with our worldwide repair facilities. The advantage for you: Defects can be rectified before they cause further harm.

Repair is a favorable option when you have specific reasons for not replacing the defective device or part with a new one (delivery as exchange product).

We maintain a global network of Siemens repair shops and certified partners to ensure that we will always be able to process your repairs quickly.

We can offer you different types of repair depending on your requirements:

##### Normal repair

Normal repair at standard conditions normally takes 10 working days following receipt of the defective item at our repair shop.

##### Fast repair

In particularly urgent cases, we offer you the option of a fast repair within 1 or 2 working days for many products at additional cost.

##### Turnaround repair

With a turnaround repair, we organize on your behalf collection of the device/component to be repaired.

##### Mobile repair service

We come to you and perform the required repairs on site, for example, when the device/component cannot be removed due to its weight.

#### Overview (continued)

##### Function repair

A function repair is the same as a normal repair but excludes the repair of cosmetic defects, e.g. scratches, labels, discoloration. The conditions applicable to function repairs should be observed in this case. The function repair service is only available for machine manufacturers or machine operators. Please ask your regional Siemens contact.

For repairs, we require the following information:

- Reason for return
- If defective: detailed fault report
- Machine number
- Machine/system manufacturer
- End customer

#### Benefits

- Short downtimes for machines and plants
- Only certified original parts are used
- Additional services from Siemens:
  - Longer availability of your machine/plant through the preventive replacement of wear parts and aging parts
  - Highest standards of quality
  - Use of the comprehensive test concept of series production, including software, firmware, ASICs, complex function blocks, etc.
  - Implementation of all the hardware and software/firmware enhancements known by development, production, service and quality management departments, as well as suppliers
- Information supplied by repair report/inspection report

## Services and documentation

### Spare parts services

#### Product upgrade service

##### Overview

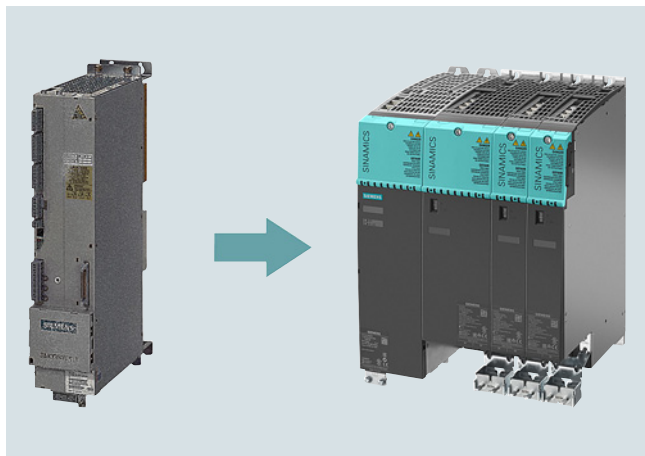

Product upgrade service: From OLD to NEW

A long service life is expected from machines and plants. The service life of the electronic components is, however, limited and normally shorter than the planned machine/plant operating times. To ensure that the required extended availability of the machine/plant is achieved, we offer you the product upgrade service at an attractive price.

In the course of their lifecycle, electronic components are normally redesigned/upgraded several times. With the product upgrade service, you will always receive the latest technology.

##### Overview (continued)

A planned product upgrade from OLD to NEW helps to prevent unplanned machine stoppages and supports a safer and longer machine/plant availability. The upgrade service is mainly offered for older components that will soon be discontinued.

For information about potential upgrades from the latest upgrade list, please ask your regional Siemens contact. The product upgrade service is only available for machine manufacturers or machine operators.

##### Benefits

- Price benefit through upgrade service
- New liability for defects for the new component
- Extended availability of your machine/plant
- Prevention of component failures due to wear and aging
- Prevention of machine stoppages due to unavailability of spare parts
- Reduced spare parts inventories
- Latest technology
- Easier servicing due to fewer variants
- Industry Services through Siemens are assured for the future

#### General overhaul

##### Overview

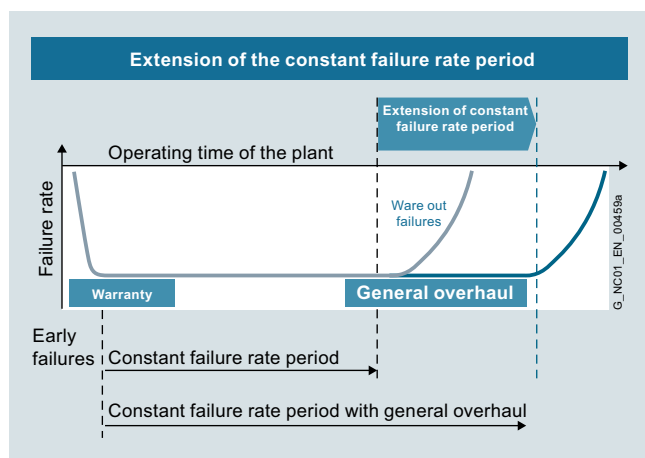

Extension of the period with a constant failure rate

A long service life is expected from machines and plants. The service life of electronic components and mechanical parts is, however, limited and normally shorter than the planned machine/plant operating times. For higher availability of the machines or plants, we offer a general overhaul (preventive maintenance) for electronic components and motors at favorable conditions.

##### Overview (continued)

During the planned general overhaul, wear parts and aging parts are replaced in accordance with their stated service life so as to reduce unplanned downtimes. In the case of motors, in addition to a general overhaul, replacement of bearings and encoders is also offered.

If a fault is detected during a general overhaul, troubleshooting and repair will be performed at the repair price without requesting confirmation or interrupting the process. In the case of extensive wear or damage, a general overhaul/repair will not be performed. A fixed lump sum for expenses will be charged in this case.

##### Benefits

- Preventive replacement of wear parts and aging parts in accordance with their stated service life
- Reduction in unplanned plant stoppages
- Enhanced production reliability
- Extended availability of your machine/plant
- New liability for defects for 12 months for the components subjected to a general overhaul
- Low price



#### Overview

It is checked that the components function reliably.

The first step involves cleaning the component. Then all the hardware and software/firmware enhancements are implemented that are known by development, production, service and quality management departments, as well as suppliers. Using the comprehensive test concept of series production, all the functions of the software, firmware, ASICs, complex and less complex function blocks are checked.

If a fault is detected during the function check, troubleshooting and repair will be performed at the repair price without requesting confirmation or interrupting the process. In the case of extensive wear or damage, no repairs will be performed. A fixed lump sum for expenses will be charged.

#### Benefits

- The component is checked and can be deployed again
- The component contains all the known improvements
- The customer's own spare parts stock is up-to-date
- Low price

### Return of diagnostic parts

#### Overview



Spare parts used for diagnostic purposes from the spare parts store can be returned within 3 months and a credit note for up to 85 % is issued.

For unused spare parts in their original packaging, you will receive a credit of 100 % in which case you will be charged a fixed price for handling.

#### Benefits

- Can be used for diagnostics
- Reduced spare parts inventories
- Low costs

## Services and documentation

### Spare parts services

#### Stock reduction in spare parts store

##### Overview



Thanks to fast delivery of spare parts from Siemens, manufacturers and plant operators are able to reduce their spare parts inventories. Siemens offers an analysis for this purpose to indicate exactly which parts must be available in the customer's stores for a specific combination of machines and which should be obtained directly from Siemens.

##### Benefits

- Reduced costs
- Stock optimization
- Minimization of fault downtimes

## 4

#### Extended spare part availability

##### Overview

We normally retain spare parts for all products and systems for a period of 10 years after discontinuation of product marketing.

In individual cases, when we do not carry spare parts, we will offer a repair.

For a wide range of products and systems, we extend the availability of spare parts. We can provide you with the current spare parts availability for your machine/plant as a service once you have registered online with identSNAPSHOT.

[www.siemens.com/identsnapshot](http://www.siemens.com/identsnapshot)

If you require longer availability of spare parts, please contact your regional sales representative.

##### Benefits

- Higher plant availability
- Investment protection
- Reduction of lifecycle costs



## Overview

### *Spares on Web – online identification of spare parts*

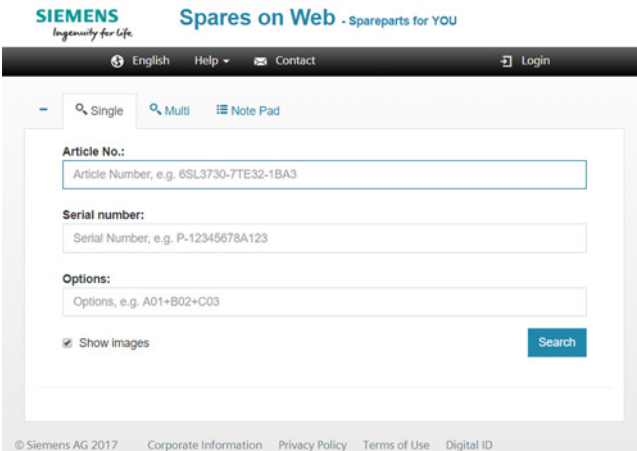

The screenshot displays the Siemens Spares on Web interface. At the top left is the Siemens logo with the tagline "Ingenuity for Life". The main heading is "Spares on Web - Spareparts for YOU". Below this is a navigation bar with "English", "Help", "Contact", and "Login" links. The search area includes three tabs: "Single" (selected), "Multi", and "Note Pad". There are three input fields: "Article No.:" with a placeholder "Article Number, e.g. 6SL3730-7TE32-1BA3", "Serial number:" with a placeholder "Serial Number, e.g. P-12345678A123", and "Options:" with a placeholder "Options, e.g. A01+B02+C03". A "Show images" checkbox is checked, and a blue "Search" button is located to the right of the options field. At the bottom of the page, there is a footer with "© Siemens AG 2017" and links for "Corporate Information", "Privacy Policy", "Terms of Use", and "Digital ID".

Spares on Web is a web-based tool for identifying spare parts. After you have entered the Article No. and serial number, the spare parts available for the relevant unit are displayed.

[www.siemens.com/sow](http://www.siemens.com/sow)

## Services and documentation

### Product Partner – Drives Options

#### Overview

##### *Siemens Product Partners for Drives Options*

###### Individual options for our drives

In order to meet as many customer requirements as possible in the field of drive technology, in addition to its own products, Siemens also relies on the individual and complementary services of selected partners.

We are increasingly focusing on the standard drive options, and our Siemens Product Partners for Drives Options supplement our drives with individual drive options.

This gives Siemens a unique flexibility to meet all application requirements. Naturally, we support our Siemens Product Partners for Drives Options in tailoring their options perfectly to our drives.

For you as our customer, there are multiple benefits:

- The Siemens Product Partners for Drives Options meet the same high standards of quality and performance that we place on our own products
- Drive options can be adapted to individual requirements/designs
- The Siemens Product Partners for Drives Options know our Siemens converter portfolio and can advise you individually and quickly

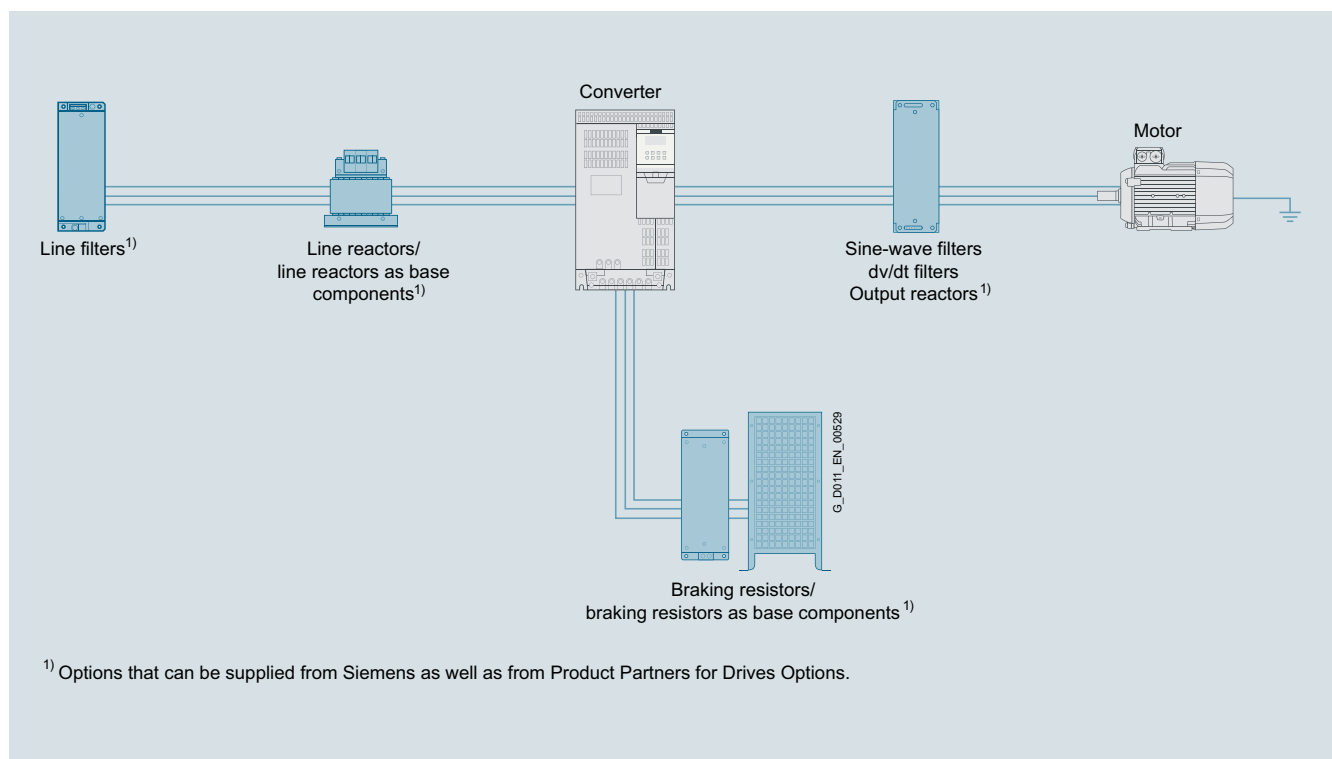

#### More information

You can find more information on the Internet at [www.siemens.com/drives-options-partner](http://www.siemens.com/drives-options-partner)

### Overview

#### mySupport documentation – Compiling personal documents

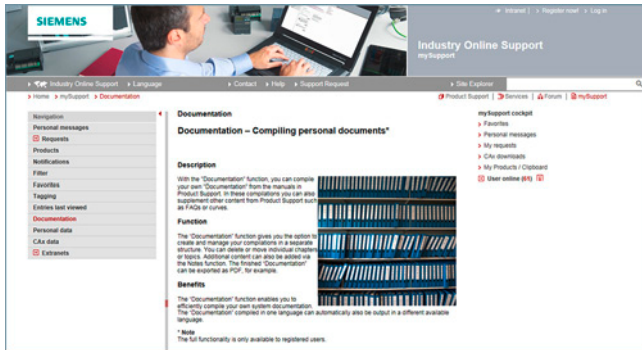

mySupport documentation is a web-based system for generating personalized documentation based on standard documents and is part of the Siemens Industry Online Support portal.

In mySupport, a personal document library can be created in the "Documentation" category. This library can be accessed online in mySupport or also be generated in various formats for offline use.

Previously, this functionality was available in the My Documentation Manager for configurable manuals. Due to the integration in mySupport, all entries of the Industry Online Support can now be imported into the personal document library, including FAQs or product notifications.

If you have already worked with the My Documentation Manager, all of the previously created libraries will continue to be available without restrictions in mySupport.

In addition, the personal library in mySupport can be shared with other mySupport users. In this way, a collection of relevant documents can be created very effectively and used together with other mySupport users all over the world.

You must register/log in for configuring and generating/managing.

### Benefits

- Display  
View, print or download standard documents or personalized documents
- Configure  
Transfer standard documents or parts of them to personalized documents
- Generate/Manage  
Generate and manage personalized documents in the formats PDF, RTF or XML in all available languages

### Function

#### Opening mySupport documentation in the Industry Online Support portal

- About the product support, entry type "Manual":  
<https://support.industry.siemens.com/cs/ww/en/ps/manual>  
By clicking on the required version of the manual and then "Show and configure", the manual opens in a modular view, where you can navigate from topic to topic. Here the direct link to a topic can be used and made available to other users. The selected document can be added to the personal library via "mySupport Cockpit" > "Add to mySupport documentation".
- Via the direct link  
<https://support.industry.siemens.com/my/ww/en/documentation/advanced>  
After logon/registration, the online help is displayed as the current document.

### More information

You can find additional information on the Internet at

- <https://support.industry.siemens.com/my/ww/en/documentation>
- [https://support.industry.siemens.com/cs/helpcenter/en/index.htm?#persoenliche\\_bibliothek\\_aufbauen.htm](https://support.industry.siemens.com/cs/helpcenter/en/index.htm?#persoenliche_bibliothek_aufbauen.htm)

## Services and documentation

### Documentation

#### General documentation

##### Overview

A high-quality programmable control or drive system can be used to maximum effect only if the user is aware of the performance of the products used as a result of intensive training and good technical documentation.

This is becoming more important due to the shorter innovation cycles of modern automation products and the convergence of electronics and mechanical engineering.

A comprehensive range of documentation is available which includes a Getting Started guide, operating instructions, installation manuals and a list manual.

The documents are available in hardcopy form or as a PDF file for downloading from the Internet.

Information and documentation relating to SINUMERIK, SINAMICS, SIMOTION and SIMOTICS are available on the Internet at

<https://support.industry.siemens.com/cs/document/109476679>

In addition to many other useful documents, the Information and Download Center also contains catalogs about the following systems:

- SINUMERIK: NC 62, NC 81.1, NC 82
- SINAMICS: D 11, D 12, D 21.3, D 21.4, D 23.1, D 23.2, D 31.1, D 31.2, D 31.5, D 32, D 33, D 35
- SIMOTION: PM 21
- SIMOTICS: D 21.4, D 41, D 81.1, D 81.8, D 83.1

You can download these catalogs in PDF format – you don't need to log on. You can perform a targeted search using the filter box above the first displayed catalog. By entering the search term "NC 8", for example, you can locate Catalog NC 81.1 and Catalog NC 82, and by entering "ST 70" you will find Catalog ST 70 as well as the relevant news and add-ons (if available).

[www.siemens.com/industry/infocenter](http://www.siemens.com/industry/infocenter)

##### Application

###### *Explanations of the manuals:*

- **Operating Instructions**  
contain all the information needed to install the device and make electrical connections, information about commissioning and a description of the converter functions.  
Phases of use: Control cabinet construction, commissioning, operation, maintenance and servicing.
- **Hardware Installation Manual**  
contains all relevant information about the intended use of the components of a system (technical specifications, interfaces, dimensional drawings, characteristics, or possible applications), information about installation and electrical connections and information about maintenance and servicing.  
Phases of use: Control cabinet configuration/construction, maintenance and servicing.
- **Operating and Installation Instructions**  
(for converter and accessories)  
contain all relevant information about the intended use of the components, such as technical specifications, interfaces, dimensional drawings, characteristics, or possible applications.  
Phases of use: Control cabinet configuration/construction.
- **Manual/Configuration Manual**  
contains all necessary information about the intended use of the components of a system, e.g. technical specifications, interfaces, dimensional drawings, characteristics, or possible applications.  
Phases of use: Cabinet configuration/setup, circuit diagram configuration/drawing.
- **Commissioning Manual**  
contains all information relevant to commissioning after installation and wiring. It also contains all safety and warning notices relevant to commissioning in addition to overview drawings.  
Phases of use: Commissioning of components that have already been connected, configuration of system functions.
- **List Manual**  
contains all parameters, function diagrams, and faults/alarms for the product/system as well as their meanings and setting options. It contains parameter data and fault/alarm descriptions with functional correlations.  
Phases of use: Commissioning of components that have already been connected, configuration of system functions, fault cause/diagnosis.
- **Getting Started**  
provides information about getting started for the first-time user as well as references to additional information. It contains information about the basic steps to be taken during commissioning. The information in the other documentation should be carefully observed for all of the other work required.  
Phases of use: Commissioning of components that have already been connected.
- **Function Manual Drive Functions**  
contains all the relevant information about individual drive functions: Description, commissioning and integration in the drive system.  
Phases of use: Commissioning of components that have already been connected, configuration of system functions.

## Selection and ordering data

Description	Article No.
<b>Automating with PROFINET: Industrial Communication Based on Industrial Ethernet</b> <ul style="list-style-type: none"> <li>• German</li> <li>• English</li> </ul>	Via bookstore  <b>ISBN 978-3-89578-293-0</b> <b>ISBN 978-3-89578-294-7</b>
<b>Configuration Manual EMC Installation Guideline SIMOCRANE, SIMOTICS, SIMOTION, SINAMICS, SINUMERIK</b> <ul style="list-style-type: none"> <li>• German</li> <li>• English</li> <li>• Italian</li> <li>• French</li> <li>• Spanish</li> <li>• Chinese Simplified</li> </ul>	<b>6FC5297-0AD30-0AP3</b> <b>6FC5297-0AD30-0BP3</b> <b>6FC5297-0AD30-0CP3</b> <b>6FC5297-0AD30-0DP3</b> <b>6FC5297-0AD30-0EP3</b> <b>6FC5297-0AD30-0RP3</b>

## SINAMICS G120X documentation

## Overview

**Compact Installation Instructions** are supplied in hard copy form in German and English with every SINAMICS G120X. Further documentation, such as the operating instructions, is available free on the Internet at:  
[www.siemens.com/sinamics-g120x/documentation](http://www.siemens.com/sinamics-g120x/documentation)

Detailed information on the SINAMICS G120X infrastructure converters for HVAC/Water/Wastewater, including the latest technical documentation (brochures, tutorials, dimensional drawings, certificates and operating instructions), is available on the Internet at:

[www.siemens.com/sinamics-g120x](http://www.siemens.com/sinamics-g120x)

and is also available via the Drive Technology Configurator (DT Configurator) on the Internet.

The DT Configurator can be found in the Siemens Industry Mall at the following address:

[www.siemens.com/dt-configurator](http://www.siemens.com/dt-configurator)

## Services and documentation

Documentation

Notes

4



## Appendix



5/2	<b>Certificates of suitability (approvals)</b>
5/4	<b>Software licenses</b>
5/6	<b>Conversion tables</b>
5/8	<b>Metal surcharges</b>
5/11	<b>Conditions of sale and delivery</b>

## Appendix

### Certificates of suitability (approvals)





#### Overview

Many of the products in this catalog fulfill requirements, e.g. for UL, CSA or FM and are labeled with the corresponding approval designation.

All of the certificates of suitability, approvals, certificates, declarations of conformity, test certificates, e.g. CE, UL, Safety Integrated etc. have been performed with the associated system components as they are described in the Catalogs and Configuration Manuals.

The certificates are only valid if the products are used with the described system components, are installed according to the Installation Guidelines and used for their intended purpose.

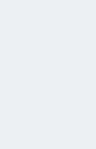
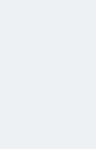
In other cases, the vendor of these products is responsible for arranging for the issue of new certificates.

Test code	Tested by	Device series/ Component	Test standard	Product category/ File No.
<b>UL: Underwriters Laboratories</b> Independent public testing body in North America				
	UL according to UL standard	SINUMERIK	Standard UL 508, CSA C22.2 No. 142	NRAQ/7.E164110 NRAQ/7.E217227
		SIMOTION	Standard UL 508, CSA C22.2 No. 142	NRAQ/7.E164110
	UL according to CSA standard	SINAMICS	Standard UL 508, 508C, 61800-5-1 CSA C22.2 No. 142, 274	NRAQ/7.E164110, NMMS/2/7/8.E192450, NMMS/7.E203250, NMMS/7.E214113, NMMS/7.E253831
				NMMS/2/7/8.E121068 NMMS/7.E355661 NMMS/7.E323473
	UL according to UL standard	SIMODRIVE	Standard UL 508C, CSA C22.2 No. 274	NMMS/2/7/8.E192450 NMMS/7.E214113
		SIMOTICS	Standard UL 1004-1, 1004-6, 1004-8, CSA C22.2 No. 100	PRGY2/8.E227215 PRHZ2/8.E93429 PRHJ2/8.E342747 PRGY2/8.E253922 PRHZ2/8.E342746
	UL according to UL and CSA standards	Line/motor reactors	Standard UL 508, 506, 5085-1, 5085-2, 1561, CSA C22.2 No. 14, 47, 66.1-06, 66.2-06	XQNX2/8.E257859 NMTR2/8.E219022 NMMS2/8.E333628 XPTQ2/8.E257852 XPTQ2/8.E103521 NMMS2/8.E224872 XPTQ2/8.E354316 XPTQ2/8.E198309 XQNX2/8.E475972
				Line filters, dv/dt filters, sine-wave filters
	UL according to UL and CSA standards	Resistors	UL 508, 508C, CSA C22.2 No. 14, 274	NMTR2/8.E224314 NMMS2/8.E192450 NMTR2/8.E221095 NMTR2/8.E226619
				<b>TUV: TÜV Rheinland of North America Inc.</b> Independent public testing body in North America, Nationally Recognized Testing Laboratory (NRTL)
<b>TÜV: TÜV SÜD Product Service</b> Independent public testing body in Germany, Nationally Recognized Testing Laboratory (NRTL) for North America				
	TUV according to UL and CSA standards	SINAMICS	NRTL listing according to standard UL 508C	U7V 12 06 20078 013 U7 11 04 20078 009 U7 11 04 20078 010 U7 11 04 20078 011
		SIMOTION	NRTL listing according to standard UL 508	U7V 13 03 20078 01
		SIMODRIVE	NRTL listing according to standard UL 508C, CSA C22.2. No. 14	CU 72090702
		Motion Control Encoder	NRTL listing according to UL 61010-1 CSA C22.2 No. 61010-1	U8V 10 06 20196 024

## Certificates of suitability (approvals)

## Overview (continued)

Test code	Tested by	Device series/ Component	Test standard	Product category/ File No.
<b>CSA: Canadian Standards Association</b> Independent public testing body in Canada				
	CSA according to CSA standard	SINUMERIK	Standard CSA C22.2 No. 142	2252-01 : LR 102527
<b>FMRC: Factory Mutual Research Corporation</b> Independent public testing body in North America				
	FM according to FM standard	SINUMERIK	Standard FMRC 3600, FMRC 3611, FMRC 3810, ANSI/ISA S82.02.1	–
<b>EAC: Ivanovo-Certificate</b> Independent public testing body in the Russian Federation				
	EAC in accordance with the EAC Directive	SINAMICS SINUMERIK SIMOTION	Standard IEC 61800-5-1/-2, IEC 61800-3	–
<b>RCM: Australian Communications and Media Authority</b> Independent public testing body in Australia				
	RCM according to EMC standard	SINAMICS SINUMERIK SIMOTION	Standard IEC AS 61800-3, EN 61800-3	–
<b>KC: National Radio Research Agency</b> Independent public testing body in South Korea				
	KC according to EMC standard	SINAMICS SINUMERIK SIMOTION	Standard KN 11	–
<b>BIA</b> Federal Institute for Occupational Safety				
–	Functional safety	SINAMICS SINUMERIK SIMOTION	Standard EN 61800-5-2	–
<b>TÜV SÜD Rail</b>				
–	Functional safety	SINAMICS SINUMERIK SIMOTION	Standard EN 61800-5-2	–

More information about certificates can be found online at:  
<https://support.industry.siemens.com/cs/ww/en/ps/cert>

## Appendix

### Software licenses

#### Overview

##### Software types

Software requiring a license is categorized into types. The following software types have been defined:

- Engineering software
- Runtime software

##### Engineering software

This includes all software products for creating (engineering) user software, e.g. for configuring, programming, parameterizing, testing, commissioning or servicing.

Data generated with engineering software and executable programs can be duplicated for your own use or for use by third-parties free-of-charge.

##### Runtime software

This includes all software products required for plant/machine operation, e.g. operating system, basic system, system expansions, drivers, etc.

The duplication of the runtime software and executable programs created with the runtime software for your own use or for use by third-parties is subject to a charge.

You can find information about license fees according to use in the ordering data (e.g. in the catalog). Examples of categories of use include per CPU, per installation, per channel, per instance, per axis, per control loop, per variable, etc.

Information about extended rights of use for parameterization/configuration tools supplied as integral components of the scope of delivery can be found in the readme file supplied with the relevant product(s).

##### License types

Siemens Industry Automation & Drive Technologies offers various types of software license:

- Floating license
- Single license
- Rental license
- Rental floating license
- Trial license
- Demo license
- Demo floating license

##### Floating license

The software may be installed for internal use on any number of devices by the licensee. Only the concurrent user is licensed. The concurrent user is the person using the program. Use begins when the software is started. A license is required for each concurrent user.

##### Single license

Unlike the floating license, a single license permits only one installation of the software per license.

The type of use licensed is specified in the ordering data and in the Certificate of License (CoL). Types of use include for example per instance, per axis, per channel, etc.

One single license is required for each type of use defined.

##### Rental license

A rental license supports the "sporadic use" of engineering software. Once the license key has been installed, the software can be used for a specific period of time (the operating hours do not have to be consecutive).

One license is required for each installation of the software.

##### Rental floating license

The rental floating license corresponds to the rental license, except that a license is not required for each installation of the software. Rather, one license is required per object (for example, user or device).

##### Trial license

A trial license supports "short-term use" of the software in a non-productive context, e.g. for testing and evaluation purposes. It can be transferred to another license.

##### Demo license

The demo license support the "sporadic use" of engineering software in a non-productive context, for example, use for testing and evaluation purposes. It can be transferred to another license. After the installation of the license key, the software can be operated for a specific period of time, whereby usage can be interrupted as often as required.

One license is required per installation of the software.

##### Demo floating license

The demo floating license corresponds to the demo license, except that a license is not required for each installation of the software. Rather, one license is required per object (for example, user or device).

##### Certificate of License (CoL)

The CoL is the licensee's proof that the use of the software has been licensed by Siemens. A CoL is required for every type of use and must be kept in a safe place.

##### Downgrading

The licensee is permitted to use the software or an earlier version/release of the software, provided that the licensee owns such a version/release and its use is technically feasible.

##### Delivery versions

Software is constantly being updated. The following delivery versions

- PowerPack
- Upgrade

can be used to access updates.

Existing bug fixes are supplied with the ServicePack version.

##### PowerPack

PowerPacks can be used to upgrade to more powerful software. The licensee receives a new license agreement and CoL (Certificate of License) with the PowerPack. This CoL, together with the CoL for the original product, proves that the new software is licensed.

A separate PowerPack must be purchased for each original license of the software to be replaced.

**Overview** (continued)**Upgrade**

An upgrade permits the use of a new version of the software on the condition that a license for a previous version of the product is already held.

The licensee receives a new license agreement and CoL with the upgrade. This CoL, together with the CoL for the previous product, proves that the new version is licensed.

A separate upgrade must be purchased for each original license of the software to be upgraded.

**ServicePack**

ServicePacks are used to debug existing products. ServicePacks may be duplicated for use as prescribed according to the number of existing original licenses.

**License key**

Siemens Industry Automation & Drive Technologies supplies software products with and without license keys.

The license key serves as an electronic license stamp and is also the "switch" for activating the software (floating license, rental license, etc.).

The complete installation of software products requiring license keys includes the program to be licensed (the software) and the license key (which represents the license).

**Software Update Service (SUS)**

As part of the SUS contract, all software updates for the respective product are made available to you free of charge for a period of one year from the invoice date. The contract will automatically be extended for one year if it is not canceled three months before it expires.

The possession of the current version of the respective software is a basic condition for entering into an SUS contract.

You can download explanations concerning license conditions from

[www.siemens.com/automation/salesmaterial-as/catalog/en/terms\\_of\\_trade\\_en.pdf](http://www.siemens.com/automation/salesmaterial-as/catalog/en/terms_of_trade_en.pdf)

## Appendix

### Conversion tables

#### Rotary inertia (to convert from A to B, multiply by entry in table)

A \ B	lb-in <sup>2</sup>	lb-ft <sup>2</sup>	lb-in-s <sup>2</sup>	lb-ft-s <sup>2</sup> slug-ft <sup>2</sup>	kg-cm <sup>2</sup>	kg-cm-s <sup>2</sup>	gm-cm <sup>2</sup>	gm-cm-s <sup>2</sup>	oz-in <sup>2</sup>	oz-in-s <sup>2</sup>
lb-in <sup>2</sup>	1	$6.94 \times 10^{-3}$	$2.59 \times 10^{-3}$	$2.15 \times 10^{-4}$	2.926	$2.98 \times 10^{-3}$	$2.92 \times 10^3$	2.984	16	$4.14 \times 10^{-2}$
lb-ft <sup>2</sup>	144	1	0.3729	$3.10 \times 10^{-2}$	421.40	0.4297	$4.21 \times 10^5$	429.71	2304	5.967
lb-in-s <sup>2</sup>	386.08	2.681	1	$8.33 \times 10^{-2}$	$1.129 \times 10^3$	1.152	$1.129 \times 10^6$	$1.152 \times 10^3$	$6.177 \times 10^3$	16
lb-ft-s <sup>2</sup> slug-ft <sup>2</sup>	$4.63 \times 10^3$	32.17	12	1	$1.35 \times 10^4$	13.825	$1.355 \times 10^7$	$1.38 \times 10^4$	$7.41 \times 10^4$	192
kg-cm <sup>2</sup>	0.3417	$2.37 \times 10^{-3}$	$8.85 \times 10^{-4}$	$7.37 \times 10^{-5}$	1	$1.019 \times 10^{-3}$	1000	1.019	5.46	$1.41 \times 10^{-2}$
kg-cm-s <sup>2</sup>	335.1	2.327	0.8679	$7.23 \times 10^{-2}$	980.66	1	$9.8 \times 10^5$	1000	$5.36 \times 10^3$	13.887
gm-cm <sup>2</sup>	$3.417 \times 10^{-4}$	$2.37 \times 10^{-6}$	$8.85 \times 10^{-7}$	$7.37 \times 10^{-8}$	$1 \times 10^{-3}$	$1.01 \times 10^{-6}$	1	$1.01 \times 10^{-3}$	$5.46 \times 10^{-3}$	$1.41 \times 10^{-5}$
gm-cm-s <sup>2</sup>	0.335	$2.32 \times 10^{-3}$	$8.67 \times 10^{-4}$	$7.23 \times 10^{-5}$	0.9806	$1 \times 10^{-3}$	980.6	1	5.36	$1.38 \times 10^{-2}$
oz-in <sup>2</sup>	0.0625	$4.34 \times 10^{-4}$	$1.61 \times 10^{-4}$	$1.34 \times 10^{-5}$	0.182	$1.86 \times 10^{-4}$	182.9	0.186	1	$2.59 \times 10^{-3}$
oz-in-s <sup>2</sup>	24.13	0.1675	$6.25 \times 10^{-2}$	$5.20 \times 10^{-3}$	70.615	$7.20 \times 10^{-2}$	$7.09 \times 10^4$	72.0	386.08	1

#### Torque (to convert from A to B, multiply by entry in table)

A \ B	lb-in	lb-ft	oz-in	N-m	kg-cm	kg-m	gm-cm	dyne-cm
lb-in	1	$8.333 \times 10^{-2}$	16	0.113	1.152	$1.152 \times 10^{-2}$	$1.152 \times 10^3$	$1.129 \times 10^6$
lb-ft	12	1	192	1.355	13.825	0.138	$1.382 \times 10^4$	$1.355 \times 10^7$
oz-in	$6.25 \times 10^{-2}$	$5.208 \times 10^{-3}$	1	$7.061 \times 10^{-3}$	$7.200 \times 10^{-2}$	$7.200 \times 10^{-4}$	72.007	$7.061 \times 10^4$
N-m	8.850	0.737	141.612	1	10.197	0.102	$1.019 \times 10^4$	$1 \times 10^7$
kg-cm	0.8679	$7.233 \times 10^{-2}$	13.877	$9.806 \times 10^{-2}$	1	$10^{-2}$	1000	$9.806 \times 10^5$
kg-m	86.796	7.233	$1.388 \times 10^3$	9.806	100	1	$1 \times 10^5$	$9.806 \times 10^7$
gm-cm	$8.679 \times 10^{-4}$	$7.233 \times 10^{-5}$	$1.388 \times 10^{-2}$	$9.806 \times 10^{-5}$	$1 \times 10^{-3}$	$1 \times 10^{-5}$	1	980.665
dyne-cm	$8.850 \times 10^{-7}$	$7.375 \times 10^{-8}$	$1.416 \times 10^{-5}$	$10^{-7}$	$1.0197 \times 10^{-6}$	$1.019 \times 10^{-8}$	$1.019 \times 10^{-3}$	1

#### Length (to convert from A to B, multiply by entry in table)

A \ B	inches	feet	cm	yd	mm	m
inches	1	0.0833	2.54	0.028	25.4	0.0254
feet	12	1	30.48	0.333	304.8	0.3048
cm	0.3937	0.03281	1	$1.09 \times 10^{-2}$	10	0.01
yd	36	3	91.44	1	914.4	0.914
mm	0.03937	0.00328	0.1	$1.09 \times 10^{-3}$	1	0.001
m	39.37	3.281	100	1.09	1000	1

#### Force (to convert from A to B, multiply by entry in table)

A \ B	lb	oz	gm	dyne	N
lb	1	16	453.6	$4.448 \times 10^5$	4.4482
oz	0.0625	1	28.35	$2.780 \times 10^4$	0.27801
gm	$2.205 \times 10^{-3}$	0.03527	1	$1.02 \times 10^{-3}$	N.A.
dyne	$2.248 \times 10^{-6}$	$3.59 \times 10^{-5}$	980.7	1	0.00001
N	0.22481	3.5967	N.A.	100000	1

#### Mass (to convert from A to B, multiply by entry in table)

A \ B	lb	oz	gm	kg	slug
lb	1	16	453.6	0.4536	0.0311
oz	$6.25 \times 10^{-2}$	1	28.35	$0.02835 \times 10^{-3}$	$1.93 \times 10^{-3}$
gm	$2.205 \times 10^{-3}$	$3.527 \times 10^{-2}$	1	$10^{-3}$	$6.852 \times 10^{-5}$
kg	2.205	35.27	$10^3$	1	$6.852 \times 10^{-2}$
slug	32.17	514.8	$1.459 \times 10^4$	14.59	1

#### Rotation (to convert from A to B, multiply by entry in table)

A \ B	rpm	rad/s	degrees/s
rpm	1	0.105	6.0
rad/s	9.55	1	57.30
degrees/s	0.167	$1.745 \times 10^{-2}$	1

**Temperature Conversion**

°F	°C	°C	°F
0	-17.8	-10	14
32	0	0	32
50	10	10	50
70	21.1	20	68
90	32.2	30	86
98.4	37	37	98.4
212	100	100	212
subtract 32 and multiply by $\frac{5}{9}$		multiply by $\frac{9}{5}$ and add 32	

**Mechanism Efficiencies**

Acme-screw with brass nut	~0.35–0.65
Acme-screw with plastic nut	~0.50–0.85
Ball-screw	~0.85–0.95
Chain and sprocket	~0.95–0.98
Preloaded ball-screw	~0.75–0.85
Spur or bevel-gears	~0.90
Timing belts	~0.96–0.98
Worm gears	~0.45–0.85
Helical gear (1 reduction)	~0.92

**Friction Coefficients**

Materials	$\mu$
Steel on steel (greased)	~0.15
Plastic on steel	~0.15–0.25
Copper on steel	~0.30
Brass on steel	~0.35
Aluminum on steel	~0.45
Steel on steel	~0.58
Mechanism	$\mu$
Ball bushings	<0.001
Linear bearings	<0.001
Dove-tail slides	~0.2++
Gibb ways	~0.5++

**Material Densities**

Material	lb-in <sup>3</sup>	gm-cm <sup>3</sup>
Aluminum	0.096	2.66
Brass	0.299	8.30
Bronze	0.295	8.17
Copper	0.322	8.91
Hard wood	0.029	0.80
Soft wood	0.018	0.48
Plastic	0.040	1.11
Glass	0.079–0.090	2.2–2.5
Titanium	0.163	4.51
Paper	0.025–0.043	0.7–1.2
Polyvinyl chloride	0.047–0.050	1.3–1.4
Rubber	0.033–0.036	0.92–0.99
Silicone rubber, without filler	0.043	1.2
Cast iron, gray	0.274	7.6
Steel	0.280	7.75

**Wire Gauges<sup>1)</sup>**

Cross-section mm <sup>2</sup>	Standard Wire Gauge (SWG)	American Wire Gauge (AWG)
0.2	25	24
0.3	23	22
0.5	21	20
0.75	20	19
1.0	19	18
1.5	17	16
2.5	15	13
4	13	11
6	12	9
10	9	7
16	7	6
25	5	3
35	3	2
50	0	1/0
70	000	2/0
95	00000	3/0
120	0000000	4/0
150	–	6/0
185	–	7/0

<sup>1)</sup> The table shows approximate SWG/AWG sizes nearest to standard metric sizes; the cross-sections do not match exactly.

## Appendix

### Metal surcharges

#### Explanation of the raw material/metal surcharges <sup>1)</sup>

##### Surcharge calculation

To compensate for variations in the price of the raw materials silver, copper, aluminum, lead, gold, dysprosium <sup>2)</sup> and/or neodym <sup>2)</sup>, surcharges are calculated on a daily basis using the so-called metal factor for products containing these raw materials. A surcharge for the respective raw material is calculated as a supplement to the price of a product if the basic official price of the raw material in question is exceeded.

The surcharges are calculated in accordance with the following criteria:

- Basic official price of the raw material  
Basic official price from the day prior to receipt of the order or prior to release order (daily price) for <sup>3)</sup>  
- Silver (sales price, processed)  
- Gold (sales price, processed)  
and for <sup>4)</sup>  
- Copper (lower DEL notation + 1 %)  
- Aluminum (aluminum in cables)  
- Lead (lead in cables)
- Metal factor of the products  
Certain products are displayed with a metal factor. The metal factor determines the official price (for those raw materials concerned) as of which the metal surcharges are applied and the calculation method used (weight or percentage method). An exact explanation is given below.

##### Structure of the metal factor

The metal factor consists of several digits; the first digit indicates whether the percentage method of calculation refers to the list price or a possible discounted price (customer net price) (L = list price / N = customer net price).

The remaining digits indicate the method of calculation used for the respective raw material. If no surcharge is added for a raw material, a "-" is used.

1st digit	List or customer net price using the percentage method
2nd digit	for silver (AG)
3rd digit	for copper (CU)
4th digit	for aluminum (AL)
5th digit	for lead (PB)
6th digit	for gold (AU)
7th digit	for dysprosium (Dy) <sup>2)</sup>
8th digit	for neodym (Nd) <sup>2)</sup>

##### Weight method

The weight method uses the basic official price, the daily price and the raw material weight. In order to calculate the surcharge, the basic official price must be subtracted from the daily price. The difference is then multiplied by the raw material weight.

The basic official price can be found in the table below using the number (1 to 9) of the respective digit of the metal factor. The raw material weight can be found in the respective product descriptions.

##### Percentage method

Use of the percentage method is indicated by the letters A-Z at the respective digit of the metal factor.

The surcharge is increased - dependent on the deviation of the daily price compared with the basic official price - using the percentage method in "steps" and consequently offers surcharges that remain constant within the framework of this "step range". A higher percentage rate is charged for each new step. The respective percentage level can be found in the table below.

##### Metal factor examples

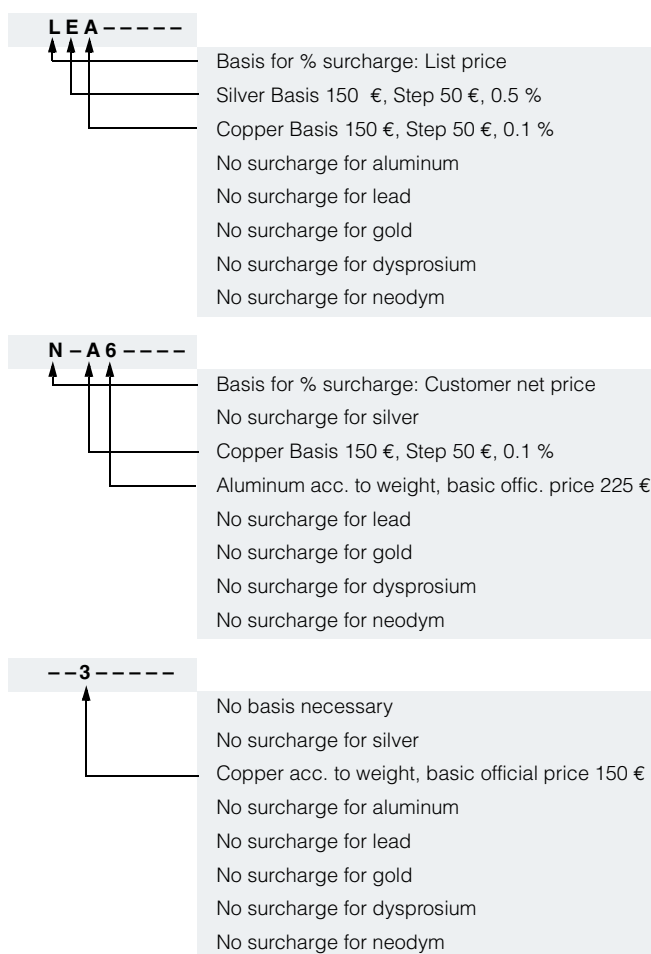

1) Refer to the separate explanation on the next page regarding the raw materials dysprosium and neodym (= rare earths).

2) For a different method of calculation, refer to the separate explanation for these raw materials on the next page.

3) Source: Umicore, Hanau ([www.metalsmanagement.umicore.com](http://www.metalsmanagement.umicore.com)).

4) Source: Schutzvereinigung DEL-Notiz e.V. ([www.del-notiz.org](http://www.del-notiz.org)).



## Explanation of the raw material/metal surcharges for dysprosium and neodym (rare earths)

### Surcharge calculation

To compensate for variations in the price of the raw materials silver <sup>1)</sup>, copper <sup>1)</sup>, aluminum <sup>1)</sup>, lead <sup>1)</sup>, gold <sup>1)</sup>, dysprosium and/or neodym, surcharges are calculated on a daily basis using the so-called metal factor for products containing these raw materials. The surcharge for dysprosium and neodym is calculated as a supplement to the price of a product if the basic official price of the raw material in question is exceeded.

The surcharge is calculated in accordance with the following criteria:

- Basic official price of the raw material <sup>2)</sup>  
Three-month basic average price (see below) in the period before the quarter in which the order was received or the release order took place (= average official price) for  
- dysprosium (Dy metal, 99 % min. FOB China; USD/kg)  
- neodym (Nd metal, 99 % min. FOB China; USD/kg)
- Metal factor of the products  
Certain products are displayed with a metal factor. The metal factor indicates (for those raw materials concerned) the basic official price as of which the surcharges for dysprosium and neodym are calculated using the weight method. An exact explanation of the metal factor is given below.

### Three-month average price

The prices of rare earths vary according to the foreign currency, and there is no freely accessible stock exchange listing. This makes it more difficult for all parties involved to monitor changes in price. In order to avoid continuous adjustment of the surcharges, but to still ensure fair, transparent pricing, an average price is calculated over a three-month period using the average monthly foreign exchange rate from USD to EUR (source: European Central Bank). Since not all facts are immediately available at the start of each month, a one-month buffer is allowed before the new average price applies.

Examples of calculation of the average official price:

Period for calculation of the average price:	Period during which the order/release order is effected and the average price applies:
Sep 2012 - Nov 2012	Q1 in 2013 (Jan - Mar)
Dec 2012 - Feb 2013	Q2 in 2013 (Apr - Jun)
Mar 2013 - May 2013	Q3 in 2013 (Jul - Sep)
Jun 2013 - Aug 2013	Q4 in 2013 (Oct - Dec)

### Structure of the metal factor

The metal factor consists of several digits; the first digit is not relevant to the calculation of dysprosium and neodym.

The remaining digits indicate the method of calculation used for the respective raw material. If no surcharge is added for a raw material, a "-" is used.

1st digit	List or customer net price using the percentage method
2nd digit	for silver (AG) <sup>1)</sup>
3rd digit	for copper (CU) <sup>1)</sup>
4th digit	for aluminum (AL) <sup>1)</sup>
5th digit	for lead (PB) <sup>1)</sup>
6th digit	for gold (AU) <sup>1)</sup>
7th digit	for dysprosium (Dy)
8th digit	for neodym (Nd)

### Weight method

The weight method uses the basic official price, the average price and the raw material weight. In order to calculate the surcharge, the basic official price must be subtracted from the average price. The difference is then multiplied by the raw material weight.

The basic official price can be found in the table below using the number (1 to 9) of the respective digit of the metal factor. Your Sales contact can inform you of the raw material weight.

### Metal factor examples

-----71	No basis necessary
	No surcharge for silver
	No surcharge for copper
	No surcharge for aluminum
	No surcharge for lead
	No surcharge for gold
	Dysprosium acc. to weight, basic official price 300 €
	Neodym acc. to weight, basic official price 50 €

1) For a different method of calculation, refer to the separate explanation for these raw materials on the previous page.

2) Source: Asian Metal Ltd ([www.asianmetal.com](http://www.asianmetal.com))

## Appendix

### Metal surcharges

#### Values of the metal factor

Percentage method	Basic official price in €	Step range in €	% surcharge 1st step	% surcharge 2nd step	% surcharge 3rd step	% surcharge 4th step	% surcharge per additional step	
			Price in € 150.01 - 200.00	Price in € 200.01 - 250.00	Price in € 250.01 - 300.00	Price in € 300.01 - 350.00		
A	150	50	0.1	0.2	0.3	0.4	0.1	
B	150	50	0.2	0.4	0.6	0.8	0.2	
C	150	50	0.3	0.6	0.9	1.2	0.3	
D	150	50	0.4	0.8	1.2	1.6	0.4	
E	150	50	0.5	1.0	1.5	2.0	0.5	
F	150	50	0.6	1.2	1.8	2.4	0.6	
G	150	50	1.0	2.0	3.0	4.0	1.0	
H	150	50	1.2	2.4	3.6	4.8	1.2	
I	150	50	1.6	3.2	4.8	6.4	1.6	
J	150	50	1.8	3.6	5.4	7.2	1.8	
			175.01 - 225.00	225.01 - 275.00	275.01 - 325.00	325.01 - 375.00		
O	175	50	0.1	0.2	0.3	0.4	0.1	
P	175	50	0.2	0.4	0.6	0.8	0.2	
R	175	50	0.5	1.0	1.5	2.0	0.5	
			225.01 - 275.00	275.01 - 325.00	325.01 - 375.00	375.01 - 425.00		
S	225	50	0.2	0.4	0.6	0.8	0.2	
U	225	50	1.0	2.0	3.0	4.0	1.0	
V	225	50	1.0	1.5	2.0	3.0	1.0	
W	225	50	1.2	2.5	3.5	4.5	1.0	
			150.01 - 175.00	175.01 - 200.00	200.01 - 225.00	225.01 - 250.00		
Y	150	25	0.3	0.6	0.9	1.2	0.3	
			400.01 - 425.00	425.01 - 450.00	450.01 - 475.00	475.01 - 500.00		
Z	400	25	0.1	0.2	0.3	0.4	0.1	
<b>Price basis (1st digit)</b>								
L	Calculation based on the list price							
N	Calculation based on the customer net price (discounted list price)							
<b>Weight method</b>	<b>Basic official price in €</b>							
1	50	Calculation based on raw material weight						
2	100							
3	150							
4	175							
5	200							
6	225							
7	300							
8	400							
9	555							
<b>Miscellaneous</b>								
-	No metal surcharge							

## 1. General Provisions

By using this catalog you can acquire hardware and software products described therein from Siemens AG subject to the following Terms and Conditions of Sale and Delivery (hereinafter referred to as "T&C"). Please note that the scope, the quality and the conditions for supplies and services, including software products, by any Siemens entity having a registered office outside Germany, shall be subject exclusively to the General Terms and Conditions of the respective Siemens entity. The following T&C apply exclusively for orders placed with Siemens Aktiengesellschaft, Germany.

### 1.1 For customers with a seat or registered office in Germany

For customers with a seat or registered office in Germany, the following applies subordinate to the T&C:

- for installation work the "General Conditions for Erection Works –Germany"<sup>1)</sup> ("Allgemeine Montagebedingungen – Deutschland" (only available in German at the moment)) and/or
- for Plant Analytics Services the "Standard Terms and Conditions for Plant Analytics Services –for Customer in Germany"<sup>1)</sup> ("Allgemeine Geschäftsbedingungen für das Plant Analytics Services –für Kunden in Deutschland" (only available in German at the moment)) and/or
- for stand-alone software products and software products forming a part of a product or project, the "General License Conditions for Software Products for Automation and Drives for Customers with a Seat or registered Office in Germany"<sup>1)</sup> and/or
- for other supplies and/or services the "General Conditions for the Supply of Products and Services of the Electrical and Electronics Industry"<sup>1)</sup>.  
In case such supplies and/or services should contain Open Source Software, the conditions of which shall prevail over the "General Conditions for the Supply of Products and Services of the Electrical and Electronics Industry"<sup>1)</sup>. A notice will be contained in the scope of delivery in which the applicable conditions for Open Source Software are specified. This shall apply mutatis mutandis for notices referring to other third party software components.

### 1.2 For customers with a seat or registered office outside Germany

For customers with a seat or registered office outside Germany, the following applies subordinate to the T&C:

- for Plant Analytics Services the "Standard Terms and Conditions for Plant Analytics Services"<sup>1)</sup> and/or
- for services the "International Terms & Conditions for Services"<sup>1)</sup> supplemented by "Software Licensing Conditions"<sup>1)</sup> and/or
- for other supplies of hard- and/or software the "International Terms & Conditions for Products"<sup>1)</sup> supplemented by "Software Licensing Conditions"<sup>1)</sup>.

### 1.3 For customers with master or framework agreement

To the extent our supplies and/or services offered are covered by an existing master or framework agreement, the terms and conditions of that agreement shall apply instead of T&C.

## 2. Prices

The prices are in € (Euro) ex point of delivery, exclusive of packaging.

The sales tax (value added tax) is not included in the prices. It shall be charged separately at the respective rate according to the applicable statutory legal regulations.

Prices are subject to change without prior notice. We will charge the prices valid at the time of delivery.

To compensate for variations in the price of raw materials (e.g. silver, copper, aluminum, lead, gold, dysprosium and neodym), surcharges are calculated on a daily basis using the so-called metal factor for products containing these raw materials. A surcharge for the respective raw material is calculated as a supplement to the price of a product if the basic official price of the raw material in question is exceeded.

The metal factor of a product indicates the basic official price (for those raw materials concerned) as of which the surcharges on the price of the product are applied, and with what method of calculation.

You will find a detailed explanation of the metal factor on the page headed "Metal surcharges".

To calculate the surcharge (except in the cases of dysprosium and neodym), the official price from the day prior to that on which the order was received or the release order was effected is used.

## 3. Additional Terms and Conditions

The dimensions are in mm. In Germany, according to the German law on units in measuring technology, data in inches apply only to devices for export.

Illustrations are not binding.

Insofar as there are no remarks on the individual pages of this catalog –especially with regard to data, dimensions and weights given –these are subject to change without prior notice.

<sup>1)</sup> The text of the Terms and Conditions of Siemens AG can be downloaded at [www.siemens.com/automation/salesmaterial-as/catalog/en/terms\\_of\\_trade\\_en.pdf](http://www.siemens.com/automation/salesmaterial-as/catalog/en/terms_of_trade_en.pdf)

## Appendix

### Conditions of sale and delivery

#### 4. Export regulations

We shall not be obligated to fulfill any agreement if such fulfillment is prevented by any impediments arising out of national or international foreign trade or customs requirements or any embargoes and/or other sanctions.

Export may be subject to license. We shall indicate in the delivery details whether licenses are required under German, European and US export lists.

Our products are controlled by the U.S. Government (when labeled with "ECCN" unequal "N") and authorized for export only to the country of ultimate destination for use by the ultimate consignee or end-user(s) herein identified. They may not be resold, transferred, or otherwise disposed of, to any other country or to any person other than the authorized ultimate consignee or end-user(s), either in their original form or after being incorporated into other items, without first obtaining approval from the U.S. Government or as otherwise authorized by U.S. law and regulations.

The export indications can be viewed in advance in the description of the respective goods on the Industry Mall, our online catalog system. Only the export labels "AL" and "ECCN" indicated on order confirmations, delivery notes and invoices are authoritative.

Products labeled with "AL" unequal "N" are subject to European / national export authorization. Products without label, with label "AL:N" / "ECCN:N", or label "AL:9X9999" / "ECCN: 9X9999" may require authorization from responsible authorities depending on the final end-use, or the destination.

If you transfer goods (hardware and/or software and/or technology as well as corresponding documentation, regardless of the mode of provision) delivered by us or works and services (including all kinds of technical support) performed by us to a third party worldwide, you must comply with all applicable national and international (re-)export control regulations.

If required for the purpose of conducting export control checks, you (upon request by us) shall promptly provide us with all information pertaining to the particular end customer, final disposition and intended use of goods delivered by us respectively works and services provided by us, as well as to any export control restrictions existing in this relation.

The products listed in this catalog may be subject to European/German and/or US export regulations. Any export requiring approval is therefore subject to authorization by the relevant authorities.

Errors excepted and subject to change without prior notice.

Further information can be obtained from our branch offices listed at [www.siemens.com/automation-contact](http://www.siemens.com/automation-contact)

<b>Interactive Catalog</b>	<i>Catalog</i>	<b>Process Instrumentation and Analytics</b>	<i>Catalog</i>
Products for Automation and Drives	<b>CA 01</b>	<i>Digital: Field Instruments for Process Automation</i>	FI 01
<b>Building Control</b>		<i>Digital: Display Recorders SIREC D</i>	MP 20
GAMMA Building Control	ET G1	<i>Digital: SIPART Controllers and Software</i>	MP 31
<b>Drive Systems</b>		Products for Weighing Technology	WT 10
SINAMICS G130 Drive Converter Chassis Units	D 11	<i>Digital: Process Analytical Instruments</i>	AP 01
SINAMICS G150 Drive Converter Cabinet Units		<i>Digital: Process Analytics, Components for Continuous Emission Monitoring</i>	AP 11
<i>Digital: SINAMICS PERFECT HARMONY GH180 Medium-Voltage Air-Cooled Drives (Germany Edition)</i>	D 15.1	<b>Low-Voltage Power Distribution and Electrical Installation Technology</b>	
SINAMICS G180 Converters – Compact Units, Cabinet Systems, Cabinet Units Air-Cooled and Liquid-Cooled	D 18.1	SENTRON · SIVACON · ALPHA Protection, Switching, Measuring and Monitoring Devices, Switchboards and Distribution Systems	LV 10
SINAMICS S120 Chassis Format Converter Units	D 21.3	Electrical Components for the Railway Industry	LV 12
SINAMICS S120 Cabinet Modules		Power Monitoring Made Simple	LV 14
SINAMICS S150 Converter Cabinet Units		Components for Industrial Control Panels according to UL Standards	LV 16
SINAMICS S120 and SIMOTICS	D 21.4	<i>Digital: Air circuit breakers and molded case circuit breakers with UL certification</i>	LV 18
SINAMICS DCM DC Converter, Control Module	D 23.1	3WT Air Circuit Breakers up to 4000 A	LV 35
SINAMICS Inverters for Single-Axis Drives · Built-In Units	D 31.1	3VT Molded Case Circuit Breakers up to 1600 A	LV 36
SINAMICS Inverters for Single-Axis Drives · Distributed Inverters	D 31.2	<i>Digital: SIVACON System Cubicles, System Lighting and System Air-Conditioning</i>	LV 50
<i>Digital: SINAMICS Converters for Single-Axis Drives · SINAMICS G120X</i>	D 31.5	<i>Digital: ALPHA Distribution Systems</i>	LV 51
<i>Digital: SINAMICS S210 Servo Drive System</i>	D 32	ALPHA FIX Terminal Blocks	LV 52
<i>Digital: SINAMICS V90 Basic Servo Drive System</i>	D 33	SIVACON S4 Power Distribution Boards	LV 56
<i>Digital: SINAMICS G120P and SINAMICS G120P Cabinet pump, fan, compressor converters</i>	D 35	SIVACON 8PS Busbar Trunking Systems	LV 70
LOHER VARIO High Voltage Motors Flameproof, Type Series 1PS4, 1PS5, 1MV4 and 1MV5 Frame Size 355 to 1000, Power Range 80 to 7100 kW	D 83.2	<i>Digital: DELTA Switches and Socket Outlets</i>	ET D1
<i>Digital: Three-Phase Induction Motors SIMOTICS HV, SIMOTICS TN</i>	D 84.1	Vacuum Switching Technology and Components for Medium Voltage	HG 11.01
<i>Digital: Three-Phase Induction Motors SIMOTICS HV</i>	D 84.3	<b>Power Supply</b>	
High Voltage Three-phase Induction Motors	D 84.9	SITOP Power supply	KT 10.1
SIMOTICS HV Series A-compact PLUS		<b>Safety Integrated</b>	
<i>Digital: Modular Industrial Generators SIGENTICS M</i>	D 85.1	Safety Technology for Factory Automation	SI 10
Synchronous Motors with Permanent-Magnet Technology, HT-direct	D 86.2	<b>SIMATIC HMI / PC-based Automation</b>	
DC Motors	DA 12	Human Machine Interface Systems/ PC-based Automation	ST 80/ ST PC
SIMOVERT PM Modular Converter Systems	DA 45	<b>SIMATIC Ident</b>	
MICROMASTER 420/430/440 Inverters	DA 51.2	Industrial Identification Systems	ID 10
MICROMASTER 411/COMBIMASTER 411	DA 51.3	<b>SIMATIC Industrial Automation Systems</b>	
<u>Low-Voltage Three-Phase-Motors</u>		Products for Totally Integrated Automation	ST 70
SIMOTOCS S-1FG1 Servo geared motors	D 41	SIMATIC PCS 7 Process Control System	ST PCS 7
SIMOTICS Low-Voltage Motors	D 81.1	System components	
SIMOTICS FD Low-Voltage Motors	D 81.8	SIMATIC PCS 7 Process Control System Technology components	ST PCS 7 T
LOHER Low-Voltage Motors	D 83.1	Add-ons for the SIMATIC PCS 7 Process Control System	ST PCS 7 AO
<i>Digital: MOTOX Geared Motors</i>	D 87.1	SIMATIC S7-400 advanced controller	ST 400
SIMOGEAR Geared Motors	MD 50.1	<b>SIMATIC NET</b>	
SIMOGEAR Electric-monorail geared motors Light-load and heavy-load applications	MD 50.8	Industrial Communication	IK PI
SIMOGEAR Gearboxes with adapter	MD 50.11	<b>SIRIUS Industrial Controls</b>	
<u>Mechanical Driving Machines</u>		<i>Digital: SIRIUS Industrial Controls</i>	IC 10
FLENDER Standard Couplings	MD 10.1		
FLENDER High Performance Couplings	MD 10.2		
FLENDER Backlash-free Couplings	MD 10.3		
FLENDER SIP Standard industrial planetary gear units	MD 31.1		
<b>Motion Control</b>			
SINUMERIK 840 Equipment for Machine Tools	NC 62		
SINUMERIK 808 Equipment for Machine Tools	NC 81.1		
SINUMERIK 828 Equipment for Machine Tools	NC 82		
SIMOTION Equipment for Production Machines	PM 21		
<i>Digital: Drive and Control Components for Cranes</i>	CR 1		

*Digital: These catalogs are only available as a PDF.***Information and Download Center**

Digital versions of the catalogs are available on the Internet at:  
[www.siemens.com/industry/infocenter](http://www.siemens.com/industry/infocenter)  
 There you'll find additional catalogs in other languages.

## Get more information

SINAMICS G120X infrastructure converters  
for HVAC/Water/Wastewater:  
[www.siemens.com/sinamics-g120x](http://www.siemens.com/sinamics-g120x)

SIMOTICS electric motors:  
[www.siemens.com/simotics](http://www.siemens.com/simotics)

Motion Control Systems and Solutions for production  
machine and machine tool equipment:  
[www.siemens.com/motioncontrol](http://www.siemens.com/motioncontrol)

Local partners worldwide:  
[www.siemens.com/automation-contact](http://www.siemens.com/automation-contact)

Siemens AG  
Digital Factory Division  
Motion Control  
Postfach 31 80  
91050 ERLANGEN  
GERMANY

© Siemens AG 2019  
Subject to change without prior notice  
(Article No. E86060-K5531-A151-A1-7600)  
V6.MKKATA.GMC.106  
KG 0219 106 En  
Produced in Germany

The information provided in this catalog contains merely general descriptions or characteristics of performance which in case of actual use do not always apply as described or which may change as a result of further development of the products. An obligation to provide the respective characteristics shall only exist if expressly agreed in the terms of contract. Availability and technical specifications are subject to change without notice.

All product designations may be trademarks or product names of Siemens AG or supplier companies whose use by third parties for their own purposes could violate the rights of the owners.

## Security information

Siemens provides products and solutions with industrial security functions that support the secure operation of plants, systems, machines and networks.

In order to protect plants, systems, machines and networks against cyber threats, it is necessary to implement – and continuously maintain – a holistic, state-of-the-art industrial security concept. Siemens' products and solutions constitute one element of such a concept.

Customers are responsible for preventing unauthorized access to their plants, systems, machines and networks. Such systems, machines and components should only be connected to an enterprise network or the internet if and to the extent such a connection is necessary and only when appropriate security measures (e.g. firewalls and/or network segmentation) are in place.

For additional information on industrial security measures that may be implemented, please visit  
<https://www.siemens.com/industrialsecurity>

Siemens' products and solutions undergo continuous development to make them more secure. Siemens strongly recommends that product updates are applied as soon as they are available and that the latest product versions are used. Use of product versions that are no longer supported, and failure to apply the latest updates may increase customer's exposure to cyber threats.

To stay informed about product updates, subscribe to the Siemens Industrial Security RSS Feed under  
<https://www.siemens.com/industrialsecurity>

Discover the  
advantages of  
Integrated Drive  
Systems at a glance

