

# SINAMICS G120X infrastructure converters for HVAC/Water/Wastewater

## 0.75 kW to 630 kW (1 hp to 700 hp)

2



<b>2/2</b>	<b>SINAMICS G120X infrastructure converters for HVAC/Water/Wastewater</b>	<b>2/52</b>	<b>Supplementary system components</b>
2/2	Overview	2/52	Operator Panels
2/3	Benefits	2/53	• IOP-2 Intelligent Operator Panel
2/4	Application	2/56	• BOP-2 Basic Operator Panel
2/4	Design	2/57	Memory cards
2/5	Function	2/58	SINAMICS G120 Smart Access
2/6	Integration	2/59	SINAMICS CONNECT 300 IoT Gateway
2/8	Configuration	2/60	SINAMICS G120X I/O Extension Module
2/10	Selection and ordering data	2/61	Push-through mounting frames for frame sizes FSA to FSG
2/10	• SINAMICS G120X converters · Degree of protection IP20/UL Open Type · 200 ... 240 V 3 AC	2/61	IP21 top covers for frame sizes FSA to FSG
2/11	- Configuration with line-side components	2/62	Wiring adapter for frame size FSG
2/13	- Configuration with load-side power components	2/63	Installation kit for line-side cable connection, left, for frame size FSH
2/14	• SINAMICS G120X converters · Degree of protection IP20/UL Open Type · 380 ... 480 V 3 AC	<b>2/63</b>	<b>Spare parts</b>
2/15	- Configuration with line-side components	2/63	FPI board for frame sizes FSH and FSJ
2/17	- Configuration with load-side power components	2/63	PSB board for frame sizes FSH and FSJ
2/18	• SINAMICS G120X converters · Degree of protection IP20/UL Open Type · 500 ... 690 V 3 AC	2/63	Current transformers for frame sizes FSH and FSJ
2/19	- Configuration with line-side components	2/64	Spare parts kit for Control Unit
2/21	- Configuration with load-side power components	2/64	Shield connection kit for Control Unit
2/22	• Supplementary system components and spare parts for SINAMICS G120X converters	2/64	Shield connection kits for Power Module
2/23	Technical specifications	2/64	Small parts assembly set for frame sizes FSD to FSG
2/46	Characteristic curves	2/65	Terminal cover kits for frame sizes FSD to FSG
2/51	Dimensional drawings	2/65	Fan units
2/51	More information	2/65	Control Units

Further information about SINAMICS G120X can be found on the internet at [www.siemens.com/sinamics-g120x](http://www.siemens.com/sinamics-g120x)

## SINAMICS G120X infrastructure converters for HVAC/Water/Wastewater

0.75 kW to 630 kW (1 hp to 700 hp)

### SINAMICS G120X infrastructure converters for HVAC/Water/Wastewater

#### Overview



SINAMICS G120X, frame sizes FSA to FSJ, degree of protection IP20, with IOP-2 Intelligent Operator Panel

Easy handling, utmost reliability, superior efficiency and advanced digitalization - Siemens offers an answer to these trends with the SINAMICS G120X converter series. SINAMICS G120X is an innovative and user-friendly converter series that has been specifically developed for applications performed in infrastructure environments such as water/wastewater, but also for tasks in building automation. In this context, the converter supports, for example, pump, fan and compressor applications through numerous integrated functionalities and combines these in one device for the target sectors.

The SINAMICS G120X converter is an integrated and efficient drive solution for a wide range of tasks. The system allows convenient handling through optimized user interfaces: IOP-2 Intelligent Operator Panel with graphic color display and the optional web server module SINAMICS G120 Smart Access - a Wi-Fi-based web server solution. Thus, the SINAMICS G120X fulfills the request for an easy and fast setup of the devices during the commissioning phase. Further, experienced users can use the full flexibility of a SINAMICS converter and adjust the relevant application to their requirements.

Totally integrated operation - this approach is also supported from ordering through to delivery.

For example, all the major features of the converter are configured and displayed in the article number. The delivery includes the complete device - as configured - that means, the converter and the selected operator panel.

In addition, SINAMICS G120X has an extremely rugged and reliable construction. The integrated DC link reactor with a maximum output of 250 kW and optional resistance to harmful gases up to environmental class 3C3 ensure a reliable, stable and largely robust operation.

The converter system is fit for digitalization. Thanks to its full integration in the SINAMICS CONNECT 300 system, data from up to eight converters can be acquired and transferred to the MindSphere cloud solution. The MindSphere application "Analyze MyDrives" facilitates the evaluation of data - tailored to individual customer needs. This simplifies the acquisition and evaluation of converter conditions.

Further, the SINAMICS G120X converter series provides innovative hardware and software functions, e.g. for controlling synchronous reluctance drive systems with SIMOTICS reluctance motors. In this way, the SINAMICS G120X converter series makes a substantial contribution towards saving energy and makes more careful use of our natural resources.

#### Portfolio range

The SINAMICS G120X converter series with degree of protection IP20/UL Open Type offers a seamless system approach in three different voltage ranges with wide options of built-in communication interfaces including PROFINET, EtherNet/IP, USS,

Modbus RTU, BACnet MS/TP and PROFIBUS DP:

- 200 V to 240 V 3 AC: 0.75 kW to 55 kW (1 hp to 75 hp)
- 380 V to 480 V 3 AC: 0.75 kW to 560 kW (1 hp to 700 hp)
- 500 V to 690 V 3 AC: 3 kW to 630 kW (4 hp to 700 hp)

#### User-friendliness

A high degree of user-friendliness is one of the main characteristics of the SINAMICS G120X:

- Operator panel with color display and extensive diagnostics functions (IOP-2 Intelligent Operator Panel)
- Two different setup options are available: Standard and quick start with graphical user guidance
- Optimized setups for pumps and fans in the web server module SINAMICS G120 Smart Access
- SINAMICS SD card for storing parameter settings, cloning and local commissioning

#### Integrated functionalities for the start/operational/stop phases of the application

SINAMICS G120X is always preset, depending on the selected converter performance. Further, the following functions can be easily selected and parameterized:

##### Start phase

During the start phase, the following functions are supported by default:

- Deragging mode for pumps for cleaning the pump system, improving efficiency and reducing wear
- Pipe filling mode for preventing pressure shocks in pipeline systems
- Two acceleration ramps for shorter start/stop times
- Flying restart of the running motor for fast hot restart
- Automatic restart function after power failure during short downtimes

##### Operating phase

During the operating phase, the following functions are supported by default:

- Continued run mode with autonomous reduction of output and pulse frequency
- PID controller for autonomous closed-loop control mode, operated according to analog input values
- Up to 16 variable-speed setpoints as fixed frequencies
- Speed monitoring via sensor (pulse input)
- Multi-pump control of up to four pumps
- Protection against blocking, leakage, dry running and cavitation
- Fire response mode for extended operation in case of emergency
- Skip frequencies for skipping critical frequencies and avoiding vibration
- Real time clock for switching over setpoints or controlling releases

##### Stop phase

During the stop phase, the following functions are supported by default:

- STO (Safe Torque Off) according to IEC 61508 SIL 3 and EN ISO 13489-1 PL e and Category 3. External components (e.g. safety relays) are necessary for using the STO safety function.
- ON/OFF2 for an optimized braking ramp
- Condensation protection for the motor
- Frost protection function for the pump

A detailed description of the functions and connection diagrams are included in the device documentation.

# SINAMICS G120X infrastructure converters for HVAC/Water/Wastewater

0.75 kW to 630 kW (1 hp to 700 hp)

## SINAMICS G120X infrastructure converters for HVAC/Water/Wastewater

### Overview

#### Commissioning of complex applications

Sample applications, which include the description and device setting, are provided for SINAMICS G120X.

The following application descriptions are available:

- Fan for exhaust air with closed-loop control of pressure and air quality
- Fan for cooling tower with closed-loop control of the cooling water temperature
- Fan for tunnel/parking garage with closed-loop control of air quality and essential service mode
- Fan for supply air with closed-loop control of pressure, temperature, air quality and flowrate
- Pumps with closed-loop control of the pressure
- Pumps with closed-loop control of the filling level
- Pumps for cooling circuits with closed-loop control of the temperature
- Compressor with closed-loop control of the pressure
- Vacuum pump with closed-loop control of the pressure

Practical application examples and descriptions are available on the internet at

[www.siemens.com/sinamics-applications](http://www.siemens.com/sinamics-applications)

### Benefits

#### Energy efficiency

SINAMICS G120X increases the efficiency and minimizes energy consumption in the complete process chain. The converter has integrated hardware as well as software functions as standard. The main features are:

- Power units with DC link reactor for extremely high active power component thanks to efficient converter topology - for the same drive power, the converter requires a lower line current than comparable converters
- Flux reduction through automatic adaptation of the motor current to the prevailing load conditions with closed-loop control modes V/f (ECO) and vector without sensor (SLVC) and savings of up to 5 % under partial load conditions
- Hibernation mode dependent on setpoints in the process
- High efficiency  $\eta \geq 98\%$

#### Application-specific commissioning and operation using operator panel

- Local commissioning without specialized knowledge of converters thanks to default settings and graphical user interface
- Unique: SINAMICS SD memory card for pre-parameterization and cloning of converter data sets
- Data backup for easy replacement
- Commissioning/diagnostics and controlling of converters

#### Flexible deployment of integrated functions

- PLC functions for local control tasks for frame sizes FSA to FSG  
Flexible use of integrated function blocks  
→ No need for additional, external components
- Four integrated PID controllers  
Distributed closed-loop control for motor-independent process control without higher-level controller (PLC)
- Three freely programmable digital timer switches  
Control for freely selectable daily and weekly programs

#### Flexible deployment across a wide range of applications

- Isolated digital inputs with separate potential group
- Isolated analog inputs
  - Potential transfer avoided
  - EMC-compliant design without the need for additional components in line with process industry requirements
- Direct connection of Pt1000/Ni1000 temperature sensors with optional SINAMICS G120X I/O Extension Module
- Connection and evaluation of a recommended, optional Pt100 temperature sensor by using a free analog input and output
- 2/3-wire control for static/pulsed signals for universal control via digital inputs
- 230 V AC relay
  - Direct control for auxiliary equipment, e.g. reactor or valve actuators
- Safety functions
  - Terminals for controlling the STO (Safe Torque Off) Safety function according to IEC 61508 SIL 3 and EN ISO 13489-1 PL e and Category 3.  
External components (e.g. safety relays) are necessary for using the STO safety function.  
For further information see the operating instructions [www.siemens.com/sinamics-g120x/documentation](http://www.siemens.com/sinamics-g120x/documentation)
- X9 terminal strip for devices in frame sizes FSH and FSJ (315 kW to 630 kW)
  - Input for external 24 V DC supply
  - Input for external alarm/fault
  - Input for EMERGENCY OFF/EMERGENCY STOP
  - Output for 24 V DC
  - Control of the main contactor
  - Feedback message "DC link charged"
- Use of the communication versions at ambient temperatures of
  - -20 °C to +55 °C: PROFINET, EtherNet/IP
  - -20 °C to +60 °C: PROFIBUS DP, USS, Modbus RTU, BACnet MS/TP
- Removable operator panel
  - Protection against unauthorized access
  - Color-coded signaling of operating states
- Replacement of individual components without the need for reinstallation
  - Plug-in version of control terminals (for replacement without removing wiring)
- Version for harsh environmental conditions
  - Coated modules for increased resistance to humidity and dust (Class 3C2)
  - PCB coating for environmental class/harmful chemical substances Class 3C3 acc. to IEC 60721-3-3: 2002

#### Extended warranty

#### Siemens offers for SINAMICS G120X an extended warranty up to 7½ years:

- 24 months of standard warranty
- Optional extension via **Service Protect**
  - 6 months free of charge after product registration at: <https://myregistration.siemens.com>
  - chargeable for additional 3 or 5 years

More information at:

<https://support.industry.siemens.com/cs/ww/en/sc/4842>

## SINAMICS G120X infrastructure converters for HVAC/Water/Wastewater

0.75 kW to 630 kW (1 hp to 700 hp)

### SINAMICS G120X infrastructure converters for HVAC/Water/Wastewater

#### Application

##### *The specialist for pump, fan and compressor applications*

SINAMICS G120X is ideally suited to pump applications (centrifugal pumps, oscillating and rotating pumps), fan applications (axial and radial fans) and compressor applications (cooling compressors, air and gas compressors). They are deployed in the water/waste water industries, in industrial environments, and in building automation.

SINAMICS G120X is ideally suited for the following applications:

- Circulating pumps for heating and cooling systems
- Pumps for pressure boosting stations
- Level control
- Fans in cooling towers
- Fans for air intake and discharge
- Fans for tunnels and multi-story car parks
- Fans for stairwells
- Compressors for cooling units

##### *Reliable operation in harsh environments*

SINAMICS G120X is suitable for use under harsh environmental conditions:

- Degree of protection IP20/UL Open Type for use in the control cabinet
- Degree of protection IP21 with optional IP21 top cover for use in lockable control rooms, including outside a control cabinet
- Degree of protection IP20 with optional push-through mounting frame for space-saving design when installed in the control cabinet; power losses are dissipated using an external heat sink, separate internal air circulation
- Use of the communication versions at ambient temperatures of
  - -20 °C to +55 °C: PROFINET, EtherNet/IP
  - -20 °C to +60 °C: PROFIBUS DP, USS, Modbus RTU, BACnet MS/TP
- Coated modules for increased resistance to humidity and dust (Class 3C2)
- Optional for environmental class/harmful chemical substances Class 3C3 acc. to IEC 60721-3-3: 2002

#### Design

SINAMICS G120X is a converter system that comprises a power output module and a control module with or without an operator panel.

The converter is configured on the basis of the power requirement and the application. State-of-the-art IGBT technology with pulse-width modulation is used for reliable and flexible motor operation. Comprehensive protection functions provide a high degree of protection for the converter and motor.

The SINAMICS G120X converters in degree of protection IP20 are intended for installation in a control cabinet.

- Selection of the line filter for line voltage 200 V to 240 V 3 AC
  - Without integrated line filter, 0.75 kW to 55 kW
- Selection of the line filter for line voltage 380 V to 480 V 3 AC
  - Without integrated line filter, 0.75 kW to 132 kW
  - With integrated line filter Category C2, 0.75 kW to 250 kW
  - With integrated line filter Category C3, 160 kW to 560 kW
  - With additional line filter Category C1 for unfiltered devices, 0.75 kW to 110 kW
  - With additional line filter Category C2 for filtered devices, 315 kW to 560 kW

- Selection of the line filter for line voltage 500 V to 690 V 3 AC
  - Without integrated line filter, 3 kW to 132 kW
  - With integrated line filter Category C2, 3 kW to 55 kW
  - With integrated line filter Category C3, 75 kW to 630 kW
  - With additional line filter Category C2 for filtered devices, 315 kW to 630 kW
- Environmental class/harmful chemical substances acc. to IEC 60721-3-3: 2002
  - Class 3C2
  - Class 3C3
- Selection of communication
  - PROFINET, EtherNet/IP
  - PROFIBUS
  - USS, Modbus RTU, BACnet MS/TP
- Selection of the operator panel
 

The operator panels support user-friendly local commissioning, control and diagnostics and enable complete converter data sets to be pre-parameterized and cloned.

  - Without operator panel
  - BOP-2 Basic Operator Panel
 

The menu prompting and the 2-line display allow for simple commissioning of the converter. Simultaneous display of the parameter and parameter value, as well as parameter filtering, means that basic commissioning of a drive can also be performed without a printed parameter list.
  - IOP-2 Intelligent Operator Panel
 

Supports entry-level personnel as well as drive experts. Thanks to the color display, a user-friendly menu structure and wizards, it is much easier to commission, diagnose and locally control standard drives.

##### *Line-side power components*

The following line-side power components are available for the SINAMICS G120X converters:

- Line filters for categories C1, C2 and C3, see above
  - With an additional line filter, the converter complies with a higher radio interference class.
- Line harmonics filters for frame sizes FSB from 5.5 kW to FSG up to 250 kW
 

The use of a line harmonics filter enables a significant reduction in unwanted harmonics. This means that a THD (I) value of less than 5 % can be achieved and compliance with the limit values according to IEC 61000-3-12, IEC 61000-2-2 and IEEE 519 is possible regardless of the network impedance.
- Line reactors for devices from 315 kW and for frame sizes FSH and FSJ
 

Line reactors smooth the current drawn by the converter and thus reduce harmonic components in the line current. Through the reduction of the current harmonics, the thermal load on the power components in the rectifier and in the DC link capacitors is reduced as well as the harmonic effects on the supply. The use of a line reactor increases the service life of the converter.

SINAMICS G120X frame sizes FSA to FSG feature an integrated DC link reactor as standard. The use of an additional line reactor is not necessary for this.

##### *Recommended line-side overcurrent protection devices and power components*

This section contains recommendations for additional line-side components, such as Siemens fuses and circuit breakers (line-side components must be dimensioned in accordance with IEC standards).

[Additional information about the listed fuses and circuit breakers is available in the Catalogs LV 10, IC 10 and IC 10 AO as well as in the Industry Mall.](#)

# SINAMICS G120X infrastructure converters for HVAC/Water/Wastewater

0.75 kW to 630 kW (1 hp to 700 hp)

## SINAMICS G120X infrastructure converters for HVAC/Water/Wastewater

### Design

#### Load-side power components

Various load-side power components are available for the SINAMICS G120X converters. These allow the use of longer shielded motor cables and increase the motor service life:

- Output reactors for frame sizes FSD to FSJ  
Output reactors reduce the rate of voltage rise (dv/dt) and the height of the current peaks, and can allow longer motor cables to be connected.
- Sine-wave filters for frame sizes FSA to FSF  
Sine-wave filters limit the rate of voltage rise (dv/dt) and the peak voltages on the motor winding. Similar to an output reactor, they enable the connection of longer motor cables.
- dv/dt filters plus VPL for frame sizes FSD to FSJ  
dv/dt filters plus VPL (Voltage Peak Limiter) limit the voltage rate-of-rise dv/dt to values of <math><500\text{ V}/\mu\text{s}</math> and the typical voltage peaks to values according to the limit value curve according to IEC/TS 60034-17: 2006.  
Standard motors with standard insulation and without insulated bearings can be used for converter operation if a dv/dt filter plus VPL is used.

#### Optional accessories

- SINAMICS memory card (SD card)
- SINAMICS G120 Smart Access for simple setup via Wi-Fi
- SINAMICS G120X I/O Extension Module for direct connection of Pt1000/Ni1000 temperature sensors<sup>1)</sup>
- Push-through mounting frame for frame sizes FSA to FSG
- Increase in degree of protection to IP21 with IP21 top covers for frame sizes FSA to FSG
- Wiring adapter for frame size FSG for optimal and space-saving wiring
- Installation kit for line-side cable connection, left, for frame size FSH
- SINAMICS CONNECT 300 for connecting up to eight converters to the MindSphere cloud

#### Note:

Shield connection kits are an integral component of the delivery.

#### Spare parts

- FPI (freely programmable interface) board for frame sizes FSH and FSJ
- PSB (power supply board) board for frame sizes FSH and FSJ
- Current transformers for frame sizes FSH and FSJ
- Spare parts kit for Control Unit for frame sizes FSA and FSJ
- Shield connection kit for Control Unit for frame sizes FSD to FSG
- Shield connection kits for Power Module for frame sizes FSA to FSG
- Small parts assembly set for frame sizes FSD to FSG
- Terminal cover kits for covering the connecting terminals for frame sizes FSD to FSG
- Fan units
  - External for frame sizes FSA to FSJ
  - Internal for frame sizes FSH and FSJ
- Control Units for frame sizes FSD to FSJ

### Function

#### Technology function

Functions specific to pumps, fans and compressors are already integrated, e.g.:

- Specific firmware functions such as deragging or pipe fill mode
- Automatic restart  
Application restart after a power failure or fault occurrence
- Flying restart  
Connection of the converter when the motor is running
- Flux reduction  
Automatic adaptation of the motor current to the prevailing load conditions in V/f control mode (ECO mode) as well as in sensorless vector control mode
- Cascade connection  
Load-dependent connection and disconnection of a maximum of three additional motors by the converter in order to provide a largely constant output power (implemented by means of an additional external circuit)
- Hibernation mode  
Startup or shutdown of the drive when the relevant value drops below an external setpoint or the internal PID controller setpoint
- Real-time clock  
For time-dependent process controls, e.g. to reduce the temperature of a heating control at night and with automatic day-light saving/standard time switchover
- Freely programmable logical function blocks for frame sizes FSA to FSG  
For simulating simple PLC functions

#### Functions especially for building technology as well as heating/air conditioning/ventilation applications

- Four integrated PID controllers  
One PID controller for controlling the drive speed as a function of pressure, temperature, flowrate, fill level, air quality and other process variables; a further three PID controllers with freely configurable outputs, e.g. for controlling valves (heating, cooling) or flaps
- Emergency mode  
Special converter operating mode that enhances the availability of the drive system in the event of a fire
- Bypass mode  
When the setpoint is reached or a fault occurs, the system changes over to line operation (implemented by means of an additional external circuit)
- Programmable time switches

<sup>1)</sup> The SINAMICS G120X I/O Extension Module (article number: **6SL3255-0BE00-0AA0**) is only supported on the SINAMICS G120X converters with FS code  $\geq 02\ 02$  (FSA to FSG) /  $02$  (FSH/FSJ) and firmware  $\geq V1.01$ .  
The FS code version of the converter is on the rating plate.  
For more information please refer to the documentation on the internet at: [www.siemens.com/sinamics-g120x/documentation](http://www.siemens.com/sinamics-g120x/documentation)

# SINAMICS G120X infrastructure converters for HVAC/Water/Wastewater

0.75 kW to 630 kW (1 hp to 700 hp)

## SINAMICS G120X infrastructure converters for HVAC/Water/Wastewater

### Integration

2

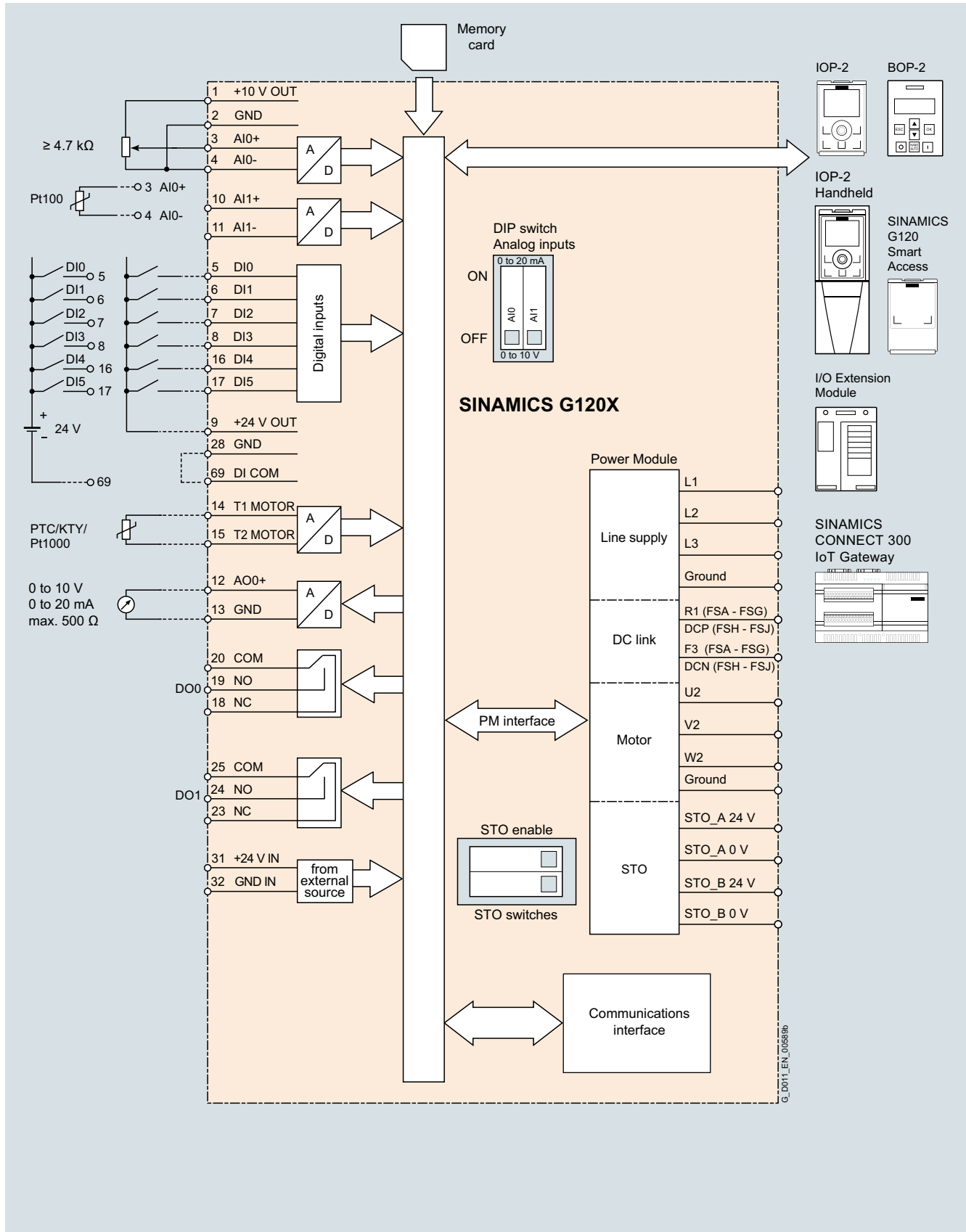

SINAMICS G120X connection diagram

# SINAMICS G120X infrastructure converters for HVAC/Water/Wastewater

0.75 kW to 630 kW (1 hp to 700 hp)

## SINAMICS G120X infrastructure converters for HVAC/Water/Wastewater

### Integration

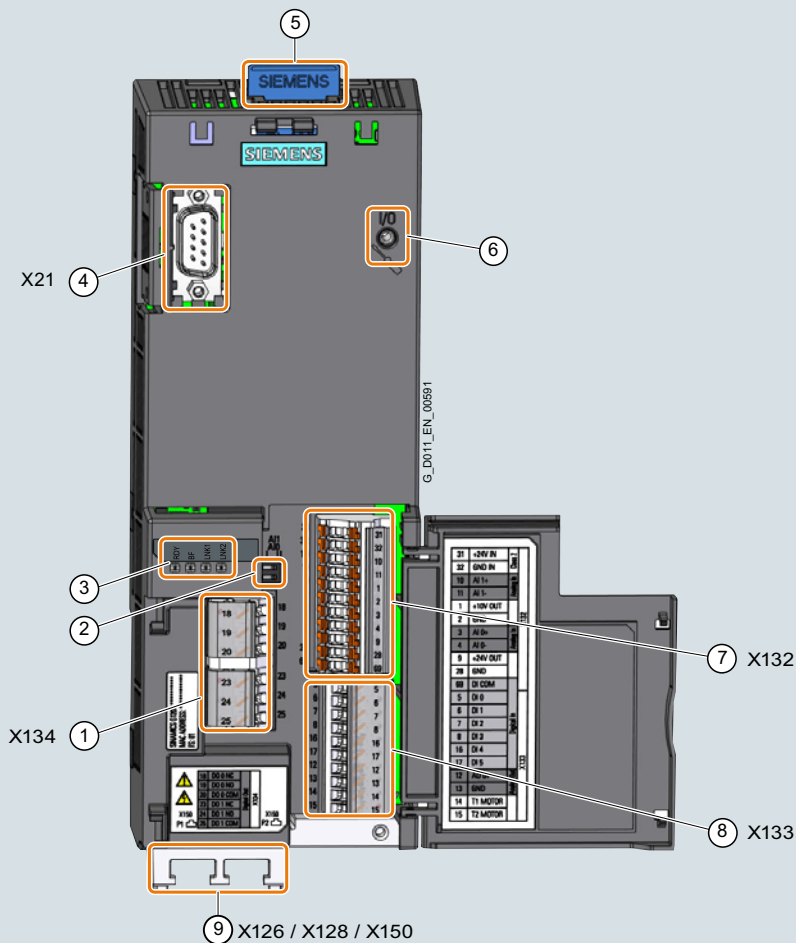

- ① Terminal strip
- ② Switch for AI 0 and AI 1 (IV)
- ③ Status LED
- ④ Connection to Operator Panel, Smart Access or I/O Extension Module
- ⑤ Memory card slot
- ⑥ For mounting the I/O Extension Module
- ⑦ ⑧ Terminal strips
- ⑨ Fieldbus interfaces on the bottom

SINAMICS G120X interface overview

## SINAMICS G120X infrastructure converters for HVAC/Water/Wastewater

0.75 kW to 630 kW (1 hp to 700 hp)

### SINAMICS G120X infrastructure converters for HVAC/Water/Wastewater

#### Configuration

The following electronic configuring guides and engineering tools are available for SINAMICS G120X converters:

##### **SINAMICS SELECTOR app**

###### Mobile selection guide for frequency converters

Siemens has developed the SINAMICS SELECTOR app as a practical tool for finding article numbers for your SINAMICS converters in the power range from 0.12 kW to 630 kW quickly and easily. Whether for SINAMICS V20, SINAMICS G120C, SINAMICS G120P, SINAMICS G120X or SINAMICS G120: The app will provide you with the correct article numbers conveniently.

How does it work? Simply select your application, the frequency converter you require, the rated power and device options as well as the necessary accessories.

Then you can save your selection and send it by email. Your pre-selection is the basis for an order specification with the dealer/Siemens.

You will find the free downloads for Android and for iOS at the following link:

[www.siemens.com/sinamics-selector](http://www.siemens.com/sinamics-selector)

##### **SINAMICS ASSISTANT app**

The error code function of the SINAMICS ASSISTANT app helps you to identify and rectify errors. Just enter the error code of your frequency converter and the app shows you what sort of error it is and how you can rectify it.

This app also recalculates for you the frequency (Hz) of a frequency converter into the speed to be set on the motor (rpm) or vice versa.

In addition, this app offers you a support page on which you can get in touch straight away with the right contact person in your region if you have any questions. Furthermore, video information is available to you free of charge, e.g. on installation and commissioning of the SINAMICS G120 frequency converter.

You will find the free downloads for Android and for iOS at the following link:

[www.siemens.com/sinamics-assistant](http://www.siemens.com/sinamics-assistant)

##### **Drive Technology Configurator (DT Configurator)**

The Drive Technology Configurator (DT Configurator) helps you to configure the optimum drive technology products for a number of applications – starting with gear units, motors, converters as well as the associated options and components and ending with controllers, software licenses and connection systems.

The DT Configurator can be used on the internet without requiring any installation. The DT Configurator can be found in the Siemens Industry Mall at the following address:

[www.siemens.com/dt-configurator](http://www.siemens.com/dt-configurator)

You can find further information on the Drive Technology Configurator (DT Configurator) in the Engineering tools section.

##### **TIA Selection Tool**

###### Selection tool and configurator for automation technology

Flawless configuration without expert knowledge through intelligent configurators and selection wizards. Desktop and cloud versions enable cross-team work with maximum flexibility.

There are two versions of the TIA Selection Tool:

- One for downloading and executing on Windows PCs (from Microsoft Windows 7)
- One for running from the cloud, which is launched from mobile devices directly in the browser (we recommend Safari, Chrome and Firefox)

Projects stored in the cloud can be edited with both tools. This makes it possible to work on-the-go using a tablet, at home on a PC – and vice versa, or together with colleagues and customers.

In order to use the full functionality, we recommended setting up a Siemens Industry Mall account for both cases. This gives you access to prices and enables you to save your projects to our cloud.

You can find more information on the TIA Selection Tool at

[www.siemens.com/tia-selection-tool](http://www.siemens.com/tia-selection-tool)

##### **SIMARIS planning tools for plants with SINAMICS drives**

###### Electrical planning: Even easier with software!

Electrical planning for power distribution in non-residential and industrial buildings has never been more complex. To ensure you, as a specialist planner, have the best hand when it comes to electrical planning with SINAMICS drives, we provide support with the following efficient software tools: SIMARIS design for dimensioning and SIMARIS project for calculating the space requirements of the distribution boards.

You can find more information on the SIMARIS planning tools for plants with SINAMICS drives in the Engineering tools section.

##### **SinaSave energy efficiency tool (available soon)**

###### Use SinaSave to calculate potential energy savings

The web-based tool SinaSave can be used to estimate the potential savings which can be achieved over the entire lifecycle, e.g. for pump and fan applications, thanks to SINAMICS. The tool takes into consideration all important plant-specific quantities, such as the power and load data of the application, the relevant control mode and the operation profile for the application in question. The result delivered by the tool specifies the potential energy savings which can be achieved with the specific application in conjunction with the Integrated Drive System or the drive component. The tool also provides a monetary evaluation of the potential savings and estimates the payback period.

You can find more information about the amortization calculator for energy-efficient drive systems at

[www.siemens.com/sinasave](http://www.siemens.com/sinasave)

You can find further information on the SinaSave energy efficiency tool in the Engineering tools section.



# SINAMICS G120X infrastructure converters for HVAC/Water/Wastewater

0.75 kW to 630 kW (1 hp to 700 hp)

## SINAMICS G120X infrastructure converters for HVAC/Water/Wastewater

### Configuration

#### **SIZER for Siemens Drives engineering tool**

The SIZER for Siemens Drives engineering tool makes it easy to configure the SINAMICS converter family. It provides support when selecting the hardware and firmware components necessary to implement a drive task. SIZER for Siemens Drives is designed to support configuring of the entire drive system.

The SIZER for Siemens Drives engineering tool is available free on the internet at [www.siemens.com/sizer](http://www.siemens.com/sizer)

You can find further information on the SIZER for Siemens Drives engineering tool in the Engineering tools section.

#### **Drive ES PCS 7 engineering system**

Drive ES PCS 7 integrates drives into the SIMATIC PCS 7 process control system. Drive ES PCS 7 provides a block library with blocks for the drives and the corresponding faceplates for the operator station.

More information about the Drive ES engineering system is available on the internet at [www.siemens.com/drive-es](http://www.siemens.com/drive-es)

#### **SINAMICS web server for SINAMICS G120X via SINAMICS G120 Smart Access**

Web server for efficient commissioning, diagnostics and maintenance

The optionally available SINAMICS G120 Smart Access provides the SINAMICS G120X drive system with a web server for efficient commissioning, diagnostics and maintenance. The web server provides access to a multi-faceted range of new options for parameter assignment and drive diagnostics for laptops, tablets and smartphones.

You can find further information on the SINAMICS web server for SINAMICS G120X via SINAMICS G120 Smart Access in the Engineering tools section.

# SINAMICS G120X infrastructure converters for HVAC/Water/Wastewater

0.75 kW to 630 kW (1 hp to 700 hp)

[Clicking to the Industry Mall](#)
**6SL3255-0AA00-5AA0**

## SINAMICS G120X infrastructure converters for HVAC/Water/Wastewater

### Selection and ordering data *NEW*

**SINAMICS G120X converters · Degree of protection IP20/UL Open Type · 200 ... 240 V 3 AC → Configuration with line-side components (see right page)**

Rated power <sup>1)</sup>		Rated output current <sup>2)</sup>		Base-load current $I_H$ <sup>3)</sup>		Rated input current <sup>4)</sup>	Frame size	SINAMICS G120X Degree of protection IP20/UL Open Type <u>without</u> integrated line filter
200 V kW	240 V hp	200 V A	240 V A	200 V A	240 V A	200 V A		Article No.
<b>200 ... 240 V 3 AC · Rated pulse frequency 4 kHz · Input frequency 47 ... 63 Hz</b>								
<b>0.75</b>	1	4.2	4.2	3.2	3.2	3.8	FSA	<b>6SL32 0- YC10- U 0 0</b>
<b>1.1</b>	1.5	6	6	4.2	4.2	5.4	FSA	<b>6SL32 0- YC12- U 0 0</b>
<b>1.5</b>	2	7.4	7.4	6	6	6.7	FSA	<b>6SL32 0- YC14- U 0 0</b>
<b>2.2</b>	3	10.4	10.4	7.4	7.4	9.6	FSB	<b>6SL32 0- YC16- U 0 0</b>
<b>3</b>	4	13.6	13.6	10.4	10.4	12.7	FSB	<b>6SL32 0- YC18- U 0 0</b>
<b>4</b>	5	17.5	17.5	13.6	13.6	16.3	FSB	<b>6SL32 0- YC20- U 0 0</b>
<b>5.5</b>	7.5	22	22	17.5	17.5	20.8	FSC	<b>6SL32 0- YC22- U 0 0</b>
<b>7.5</b>	10	28	28	22	22	26.3	FSC	<b>6SL32 0- YC24- U 0 0</b>
<b>11</b>	15	42	42	28	28	40	FSD	<b>6SL32 0- YC26- U 0 0</b>
<b>15</b>	20	54	54	42	42	51	FSD	<b>6SL32 0- YC28- U 0 0</b>
<b>18.5</b>	25	68	68	54	54	64	FSD	<b>6SL32 0- YC30- U 0 0</b>
<b>22</b>	30	80	80	68	68	76	FSE	<b>6SL32 0- YC32- U 0 0</b>
<b>30</b>	40	104	104	80	80	98	FSE	<b>6SL32 0- YC34- U 0 0</b>
<b>37</b>	50	130	130	104	104	126	FSF	<b>6SL32 0- YC36- U 0 0</b>
<b>45</b>	60	154	154	130	130	149	FSF	<b>6SL32 0- YC38- U 0 0</b>
<b>55</b>	75	192	192	154	154	172	FSF	<b>6SL32 0- YC40- U 0 0</b>

#### Article No. supplements

**Environmental class/harmful chemical substances** acc. to IEC 60721-3-3: 2002

Class 3C2

Class 3C3

#### Operator Panel

Without Operator Panel

With BOP-2 Basic Operator Panel (numeric 2-line display)

With IOP-2 Intelligent Operator Panel (graphic color display)

#### Extension with SINAMICS G120X I/O Extension Module

Without extension

With SINAMICS G120X I/O Extension Module

#### Line filter

Without integrated line filter

#### Communication

USS, Modbus RTU, BACnet MS/TP

PROFINET, EtherNet/IP

PROFIBUS DP

2  
31  
2  
30  
1

U

B  
F  
P

<sup>1)</sup> Rated power based on the base-load current  $I_L$ . The base-load current  $I_L$  is based on the duty cycle for low overload (LO).

<sup>2)</sup> The rated output current is based on the duty cycle for low overload (LO). These current values are valid for 200 V or 240 V.

<sup>3)</sup> The base-load current  $I_H$  is based on the duty cycle for high overload (HO). These current values are valid for 200 V or 240 V.

<sup>4)</sup> The input current depends on the motor load and line impedance. The input currents apply for a load at rated power (based on  $I_L$ ) for a line impedance corresponding to  $u_k = 1\%$ . The current values are specified on the rating plate of the converter.

Clicking to the Industry Mall

6SL3255-0AA00-5AA0



# SINAMICS G120X infrastructure converters for HVAC/Water/Wastewater

0.75 kW to 630 kW (1 hp to 700 hp)

## SINAMICS G120X infrastructure converters for HVAC/Water/Wastewater

### Line-side components (Configuration with load-side power components see next double page)

Line filters		Line harmonics filters	Line reactors	Recommended line-side overcurrent protection devices <sup>1)</sup>			
Category C2	Category C1			Fuses IEC-compliant		Fuses UL/cUL-compliant	
				Current		Rated voltage 600 V AC <sup>2)</sup>	Fuse type
Article No.	Article No.		Article No.	A	Article No.	Class/Article No.	Current
-	-	-	A DC line reactor is integrated for frame sizes FSA to FSF – therefore no line reactor is required.	16	<b>3NA3805</b>	J	15
-	-	-		16	<b>3NA3805</b>	J	15
-	-	-		16	<b>3NA3805</b>	J	15
-	-	-		32	<b>3NA3812</b>	J	35
-	-	-		32	<b>3NA3812</b>	J	35
-	-	-		32	<b>3NA3812</b>	J	35
-	-	-		50	<b>3NA3820</b>	J	50
-	-	-		50	<b>3NA3820</b>	J	50
-	-	-		63	<b>3NA3822</b>	J	60
-	-	-		80	<b>3NA3824</b>	J	70
-	-	-		100	<b>3NA3830</b>	J	90
-	-	-		100	<b>3NA3830</b>	J	110
-	-	-		160	<b>3NA3836</b>	J	150
-	-	-		200	<b>3NA3140</b>	J	175
-	-	-		200	<b>3NA3140</b>	J	200
-	-	-		224	<b>3NA3142</b>	J	250

<sup>1)</sup> Further information at <https://support.industry.siemens.com/cs/document/109762895>

<sup>2)</sup> The Short Circuit Current Rating (SCCR) according to UL for industrial control panel installations to NEC Article 409 or UL 508A/508C or UL 61800-5-1 is 100 kA for SINAMICS G120X.

# SINAMICS G120X infrastructure converters for HVAC/Water/Wastewater

0.75 kW to 630 kW (1 hp to 700 hp)

[Clicking to the Industry Mall](#)
**6SL3255-0AA00-5AA0**

## SINAMICS G120X infrastructure converters for HVAC/Water/Wastewater

### Selection and ordering data *NEW*

**SINAMICS G120X converters · Degree of protection IP20/UL Open Type · 200 ... 240 V 3 AC → Configuration with load-side power components (see right page)**

Rated power <sup>1)</sup>		Rated output current <sup>2)</sup>		Base-load current $I_H$ <sup>3)</sup>		Rated input current <sup>4)</sup>	Frame size	SINAMICS G120X Degree of protection IP20/UL Open Type without integrated line filter
200 V kW	240 V hp	200 V A	240 V A	200 V A	240 V A	200 V A		Article No.
<b>200 ... 240 V 3 AC · Rated pulse frequency 4 kHz · Input frequency 47 ... 63 Hz</b>								
<b>0.75</b>	1	4.2	4.2	3.2	3.2	3.8	FSA	<b>6SL32 0- YC10- U 0 0</b>
<b>1.1</b>	1.5	6	6	4.2	4.2	5.4	FSA	<b>6SL32 0- YC12- U 0 0</b>
<b>1.5</b>	2	7.4	7.4	6	6	6.7	FSA	<b>6SL32 0- YC14- U 0 0</b>
<b>2.2</b>	3	10.4	10.4	7.4	7.4	9.6	FSB	<b>6SL32 0- YC16- U 0 0</b>
<b>3</b>	4	13.6	13.6	10.4	10.4	12.7	FSB	<b>6SL32 0- YC18- U 0 0</b>
<b>4</b>	5	17.5	17.5	13.6	13.6	16.3	FSB	<b>6SL32 0- YC20- U 0 0</b>
<b>5.5</b>	7.5	22	22	17.5	17.5	20.8	FSC	<b>6SL32 0- YC22- U 0 0</b>
<b>7.5</b>	10	28	28	22	22	26.3	FSC	<b>6SL32 0- YC24- U 0 0</b>
<b>11</b>	15	42	42	28	28	40	FSD	<b>6SL32 0- YC26- U 0 0</b>
<b>15</b>	20	54	54	42	42	51	FSD	<b>6SL32 0- YC28- U 0 0</b>
<b>18.5</b>	25	68	68	54	54	64	FSD	<b>6SL32 0- YC30- U 0 0</b>
<b>22</b>	30	80	80	68	68	76	FSE	<b>6SL32 0- YC32- U 0 0</b>
<b>30</b>	40	104	104	80	80	98	FSE	<b>6SL32 0- YC34- U 0 0</b>
<b>37</b>	50	130	130	104	104	126	FSF	<b>6SL32 0- YC36- U 0 0</b>
<b>45</b>	60	154	154	130	130	149	FSF	<b>6SL32 0- YC38- U 0 0</b>
<b>55</b>	75	192	192	154	154	172	FSF	<b>6SL32 0- YC40- U 0 0</b>

#### Article No. supplements

**Environmental class/harmful chemical substances** acc. to IEC 60721-3-3: 2002

Class 3C2

Class 3C3

#### Operator Panel

Without Operator Panel

With BOP-2 Basic Operator Panel (numeric 2-line display)

With IOP-2 Intelligent Operator Panel (graphic color display)

#### Extension with SINAMICS G120X I/O Extension Module

Without extension

With SINAMICS G120X I/O Extension Module

#### Line filter

Without integrated line filter

#### Communication

USS, Modbus RTU, BACnet MS/TP

PROFINET, EtherNet/IP

PROFIBUS DP

2  
31  
2  
30  
1

U

B  
F  
P

<sup>1)</sup> Rated power based on the base-load current  $I_L$ . The base-load current  $I_L$  is based on the duty cycle for low overload (LO).

<sup>2)</sup> The rated output current is based on the duty cycle for low overload (LO). These current values are valid for 200 V or 240 V.

<sup>3)</sup> The base-load current  $I_H$  is based on the duty cycle for high overload (HO). These current values are valid for 200 V or 240 V.

<sup>4)</sup> The input current depends on the motor load and line impedance. The input currents apply for a load at rated power (based on  $I_L$ ) for a line impedance corresponding to  $u_k = 1\%$ . The current values are specified on the rating plate of the converter.

Clicking to the Industry Mall

6SL3255-0AA00-5AA0

# SINAMICS G120X infrastructure converters for HVAC/Water/Wastewater

0.75 kW to 630 kW (1 hp to 700 hp)

## SINAMICS G120X infrastructure converters for HVAC/Water/Wastewater

**Load-side power components** (Configuration with line-side components see double page before)

Output reactors	Sine-wave filters	dv/dt filters plus VPL
Article No.	Article No.	Article No.
-	-	-
-	-	-
-	-	-
-	-	-
-	-	-
-	-	-
-	-	-
-	-	-
-	-	-
-	-	-
-	-	-
-	-	-
-	-	-
-	-	-
-	-	-
-	-	-
-	-	-
-	-	-
-	-	-
-	-	-
-	-	-
-	-	-
-	-	-
-	-	-
-	-	-

### Ordering examples

Basic selection

**SINAMICS G120X converters · degree of protection IP20/UL Open Type · 200 ... 240 V 3 AC, 15 kW · without integrated line filter**

#### Article No. supplements

**Environmental class/harmful chemical substances** acc. to IEC 60721-3-3: 2002

Class 3C2

Class 3C3

#### Operator Panel

With BOP-2 Basic Operator Panel (numeric 2-line display)

With IOP-2 Intelligent Operator Panel (graphic color display)

#### Extension with SINAMICS G120X I/O Extension Module

Without extension

With SINAMICS G120X I/O Extension Module

#### Line filter

Without integrated line filter

#### Communication

USS, Modbus RTU, BACnet MS/TP

PROFINET, EtherNet/IP

PROFIBUS DP

**Complete Article No.**

Example 1

Example 2

6SL32 0- YC28- U 0 6SL32 0- YC28- U 0

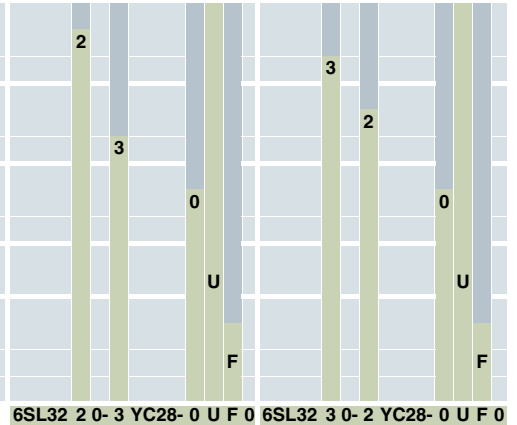

# SINAMICS G120X infrastructure converters for HVAC/Water/Wastewater

0.75 kW to 630 kW (1 hp to 700 hp)

Clicking to the Industry Mall

6SL3255-0AA00-5AA0

## SINAMICS G120X infrastructure converters for HVAC/Water/Wastewater

### Selection and ordering data

SINAMICS G120X converters · Degree of protection IP20/UL Open Type · 380 ... 480 V 3 AC → Configuration with line-side components (see right page)

Rated power <sup>1)</sup>	Rated output current <sup>2)</sup>		Base-load current $I_H$ <sup>3)</sup>		Rated input current <sup>4)</sup>	Frame size	SINAMICS G120X Degree of protection IP20/UL Open Type without integrated line filter Converters up to 132 kW delivery ex stock	SINAMICS G120X Degree of protection IP20/UL Open Type with integrated line filter Converters up to 132 kW delivery ex stock	
	400 V	480 V	400 V	480 V					400 V
kW	hp	A	A	A	A	A	Article No.	Article No.	
<b>380 ... 480 V 3 AC · Rated pulse frequency 4 kHz ≤ 90 kW, 2 kHz for 110 kW to 250 kW and 4 kHz &gt; 250 kW · Input frequency 47 ... 63 Hz</b>									
0.75	1	2.2	2.1	1.7	1.6	2.1	FSA	6SL32 0- YE10- U 0	6SL32 0- YE10- A 0
1.1	1.5	3.1	3	2.2	2.1	2.8	FSA	6SL32 0- YE12- U 0	6SL32 0- YE12- A 0
1.5	2	4.1	3.4	3.1	3	3.6	FSA	6SL32 0- YE14- U 0	6SL32 0- YE14- A 0
2.2	3	5.9	4.8	4.1	3.4	5.5	FSA	6SL32 0- YE16- U 0	6SL32 0- YE16- A 0
3	4	7.7	6.2	5.9	4.8	6.9	FSA	6SL32 0- YE18- U 0	6SL32 0- YE18- A 0
4	5	10.2	7.6	7.7	6.2	9.8	FSB	6SL32 0- YE20- U 0	6SL32 0- YE20- A 0
5.5	7.5	13.2	11	10.2	7.6	12	FSB	6SL32 0- YE22- U 0	6SL32 0- YE22- A 0
7.5	10	18	14	13.2	11	17	FSB	6SL32 0- YE24- U 0	6SL32 0- YE24- A 0
11	15	26	21	18	14	24.5	FSC	6SL32 0- YE26- U 0	6SL32 0- YE26- A 0
15	20	32	27	26	21	29.5	FSC	6SL32 0- YE28- U 0	6SL32 0- YE28- A 0
18.5	25	38	34	32	27	36	FSD	6SL32 0- YE30- U 0	6SL32 0- YE30- A 0
22	30	45	40	38	34	42	FSD	6SL32 0- YE32- U 0	6SL32 0- YE32- A 0
30	40	60	52	45	40	57	FSD	6SL32 0- YE34- U 0	6SL32 0- YE34- A 0
37	50	75	65	60	52	70	FSD	6SL32 0- YE36- U 0	6SL32 0- YE36- A 0
45	60	90	77	75	65	86	FSE	6SL32 0- YE38- U 0	6SL32 0- YE38- A 0
55	75	110	96	90	77	104	FSE	6SL32 0- YE40- U 0	6SL32 0- YE40- A 0
75	100	145	124	110	96	140	FSF	6SL32 0- YE42- U 0	6SL32 0- YE42- A 0
90	125	178	156	145	124	172	FSF	6SL32 0- YE44- U 0	6SL32 0- YE44- A 0
110	150	205	180	178	156	198	FSF	6SL32 0- YE46- U 0	6SL32 0- YE46- A 0
132	200	250	240	205	180	242	FSF	6SL32 0- YE48- U 0	6SL32 0- YE48- A 0
160	250	302	302	250	240	301	FSG	–	6SL32 0- YE50- A 0
200	300	370	361	302	302	365	FSG	–	6SL32 0- YE52- A 0
250	400	477	477	370	361	471	FSG	–	6SL32 0- YE54- A 0
315	400	570	477	468	390	585	FSH	–	6SL32 2 0- YE56- C 0
355	450	640	515	491	394	654	FSH	–	6SL32 2 0- YE58- C 0
400	500	720	590	551	452	735	FSH	–	6SL32 2 0- YE60- C 0
450	500	820	663	672	542	850	FSJ	–	6SL32 2 0- YE62- C 0
500	600	890	724	728	591	924	FSJ	–	6SL32 2 0- YE64- C 0
560	700	1000	830	786	652	1038	FSJ	–	6SL32 2 0- YE66- C 0

#### Article No. supplements

Environmental class/harmful chemical substances acc. to IEC 60721-3-3: 2002

Class 3C2 – **delivery ex stock**

Class 3C3 \*

#### Operator Panel

Without Operator Panel \*

With BOP-2 Basic Operator Panel (numeric 2-line display) \*

With IOP-2 Intelligent Operator Panel (graphic color display) – **delivery ex stock**

#### Extension with SINAMICS G120X I/O Extension Module

Without extension – **delivery ex stock**

With SINAMICS G120X I/O Extension Module \*

#### Line filter

Without integrated line filter – **delivery ex stock**

With integrated line filter Category C2 – **delivery ex stock**

With integrated line filter Category C3 \*

#### Communication

USS, Modbus RTU, BACnet MS/TP \*

PROFINET, EtherNet/IP – **delivery ex stock**

PROFIBUS DP \*

\* If you select one of these supplements, the delivery time for converters up to 132 kW will change from "delivery ex stock" to "standard delivery time".

<sup>1)</sup> Rated power based on the base-load current  $I_L$ . The base-load current  $I_L$  is based on the duty cycle for low overload (LO).

<sup>2)</sup> The rated output current is based on the duty cycle for low overload (LO). These current values are valid for 400 V or 480 V.

<sup>3)</sup> The base-load current  $I_H$  is based on the duty cycle for high overload (HO). These current values are valid for 400 V or 480 V.

<sup>4)</sup> The input current depends on the motor load and line impedance. The input currents apply for a load at rated power (based on  $I_L$ ) for a line impedance corresponding to  $u_k = 1\%$ . The current values are specified on the rating plate of the converter.

Clicking to the Industry Mall

6SL3255-0AA00-5AA0

# SINAMICS G120X infrastructure converters for HVAC/Water/Wastewater

0.75 kW to 630 kW (1 hp to 700 hp)

## SINAMICS G120X infrastructure converters for HVAC/Water/Wastewater

**Line-side components** (Configuration with load-side power components see next double page)

Line filters		Line harmonics filters <sup>1)</sup> (THD(I) < 5 %)  The prefix "UAC:" is part of a Siemens internal order code that does not belong to the product number of the original manufacturer.	Line reactors		Recommended line-side overcurrent protection devices <sup>4)</sup>			
Category C2	Category C1 Mandatory for • FSA to FSF ≤ 90 kW: Converter without integrated line filter • FSF 110 kW: Converter with integrated line filter		For frame sizes FSH and FSJ mandatory when using an external line filter Category C2	Fuses IEC-compliant	Fuses UL/cUL-compliant Rated voltage 600 V AC <sup>5)</sup>	Current A	Article No.	Fuse type Class/Article No.
Article No.	Article No.		Article No.					
SINAMICS G120X available with integrated line filter Category C2	6SL3203-0BE17-7BA1 <sup>6)</sup>	–	A DC line reactor is integrated for frame sizes FSA to FSG – therefore no line reactor is required.	16	3NA3805	J	15	
	–	–		16	3NA3805	J	15	
	–	–		16	3NA3805	J	15	
	–	–		16	3NA3805	J	15	
	–	–		16	3NA3805	J	15	
	–	–		32	3NA3812	J	35	
	6SL3203-0BE21-8BA0 <sup>6)</sup>	–		32	3NA3812	J	35	
	–	UAC:FN34406112E2XXJRX		32	3NA3812	J	35	
	–	UAC:FN34408112E2XXJRX		50	3NA3820	J	50	
	6SL3203-0BE23-8BA0 <sup>6)</sup>	UAC:FN344011113E2FAJRX		50	3NA3820	J	50	
	–	UAC:FN344015113E2FAJRX		63	3NA3822	J	60	
	6SL3203-0BE23-8BA0	UAC:FN344019113E2FAJRX		80	3NA3824	J	70	
	–	UAC:FN344022115E2FAJRX		100	3NA3830	J	90	
	6SL3203-0BE27-5BA0	UAC:FN344030115E2FAJRX		100	3NA3830	J	100	
	–	UAC:FN344037115E2FAJRX		125	3NA3832	J	125	
	6SL3203-0BE31-1BA0	UAC:FN344045115E2FAJRX		160	3NA3836	J	150	
	–	UAC:FN344055115E2FAJRX		200	3NA3140	J	200	
	6SL3000-0BE31-2DA0	UAC:FN344075116E2FAJRX		224	3NA3142	J	250	
	–	UAC:FN344090116E2FAJRX		300	3NA3250	J	300	
	6SL3203-0BE31-8BA0	UAC:FN3440110118E2FAJRX		315	3NA3252	J	350	
	–	UAC:FN3440132118E2FAJXX		355	3NA3254	J	400	
	–	UAC:FN3440160118E2FAJXX <sup>2)</sup>		400	3NA3260	J	500	
	–	UAC:FN3440200118E2FAJXX <sup>2)</sup>		630	3NA3372	J	600	
	–	UAC:FN3440132118E2FAJXX (2x) <sup>2)3)</sup>		710	3NE1437-2		710	
	6SL3760-0MR00-0AA0	–		800	3NE1438-2		800	
	–	–		850	3NE1448-2		850	
	–	–		1000	3NB3350-1KK26		1000	
–	–	1100	3NB3351-1KK26		1100			
–	–	1250	3NB3352-1KK26		1250			
–	–	6SL3000-0CE36-3AA0						
–	–	6SL3000-0CE37-7AA0						
–	–	6SL3000-0CE38-7AA0						
–	–	6SL3000-0CE41-0AA0						

<sup>1)</sup> Voltage 380 V to 415 V, frequency 50 Hz.

<sup>2)</sup> For 160 kW, 200 kW and 250 kW, only operation in Vector Control is permitted. V/f must not be used.

<sup>3)</sup> 250 kW with parallel connection of 2x 132 kW.

<sup>4)</sup> Further information at <https://support.industry.siemens.com/cs/document/109762895>

<sup>5)</sup> The Short Circuit Current Rating (SCCR) according to UL for industrial control panel installations to NEC Article 409 or UL 508A/508C or UL 61800-5-1 is 100 kA for SINAMICS G120X.

<sup>6)</sup> The line filters are suitable for base mounting for SINAMICS G120X frame sizes FSA to FSC. Further information especially to achieve EMC Category C1 is available in the documentation on the internet at: [www.siemens.com/sinamics-g120x/documentation](http://www.siemens.com/sinamics-g120x/documentation)

# SINAMICS G120X infrastructure converters for HVAC/Water/Wastewater

0.75 kW to 630 kW (1 hp to 700 hp)

Clicking to the Industry Mall

6SL3255-0AA00-5AA0



## SINAMICS G120X infrastructure converters for HVAC/Water/Wastewater

### Selection and ordering data

SINAMICS G120X converters · Degree of protection IP20/UL Open Type · 380 ... 480 V 3 AC → Configuration with load-side power components (see right page)

Rated power <sup>1)</sup>	Rated output current <sup>2)</sup>		Base-load current <sup>3)</sup>		Rated input current <sup>4)</sup>	Frame size	SINAMICS G120X Degree of protection IP20/UL Open Type without integrated line filter Converters up to 132 kW delivery ex stock	SINAMICS G120X Degree of protection IP20/UL Open Type with integrated line filter Converters up to 132 kW delivery ex stock	
	400 V	480 V	400 V	480 V					
kW	hp	A	A	A	A		10 ... 48	10 ... 48	
Article No. ↓↓									
<b>380 ... 480 V 3 AC · Rated pulse frequency 4 kHz ≤ 90 kW, 2 kHz for 110 kW to 250 kW and 4 kHz &gt; 250 kW · Input frequency 47 ... 63 Hz</b>									
0.75	1	2.2	2.1	1.7	1.6	2.1	FSA	6SL32 0- YE10- U 0	6SL32 0- YE10- A 0
1.1	1.5	3.1	3	2.2	2.1	2.8	FSA	6SL32 0- YE12- U 0	6SL32 0- YE12- A 0
1.5	2	4.1	3.4	3.1	3	3.6	FSA	6SL32 0- YE14- U 0	6SL32 0- YE14- A 0
2.2	3	5.9	4.8	4.1	3.4	5.5	FSA	6SL32 0- YE16- U 0	6SL32 0- YE16- A 0
3	4	7.7	6.2	5.9	4.8	6.9	FSA	6SL32 0- YE18- U 0	6SL32 0- YE18- A 0
4	5	10.2	7.6	7.7	6.2	9.8	FSB	6SL32 0- YE20- U 0	6SL32 0- YE20- A 0
5.5	7.5	13.2	11	10.2	7.6	12	FSB	6SL32 0- YE22- U 0	6SL32 0- YE22- A 0
7.5	10	18	14	13.2	11	17	FSB	6SL32 0- YE24- U 0	6SL32 0- YE24- A 0
11	15	26	21	18	14	24.5	FSC	6SL32 0- YE26- U 0	6SL32 0- YE26- A 0
15	20	32	27	26	21	29.5	FSC	6SL32 0- YE28- U 0	6SL32 0- YE28- A 0
18.5	25	38	34	32	27	36	FSD	6SL32 0- YE30- U 0	6SL32 0- YE30- A 0
22	30	45	40	38	34	42	FSD	6SL32 0- YE32- U 0	6SL32 0- YE32- A 0
30	40	60	52	45	40	57	FSD	6SL32 0- YE34- U 0	6SL32 0- YE34- A 0
37	50	75	65	60	52	70	FSD	6SL32 0- YE36- U 0	6SL32 0- YE36- A 0
45	60	90	77	75	65	86	FSE	6SL32 0- YE38- U 0	6SL32 0- YE38- A 0
55	75	110	96	90	77	104	FSE	6SL32 0- YE40- U 0	6SL32 0- YE40- A 0
75	100	145	124	110	96	140	FSF	6SL32 0- YE42- U 0	6SL32 0- YE42- A 0
90	125	178	156	145	124	172	FSF	6SL32 0- YE44- U 0	6SL32 0- YE44- A 0
110	150	205	180	178	156	198	FSF	6SL32 0- YE46- U 0	6SL32 0- YE46- A 0
132	200	250	240	205	180	242	FSF	6SL32 0- YE48- U 0	6SL32 0- YE48- A 0
160	250	302	302	250	240	301	FSG	-	6SL32 0- YE50- A 0
200	300	370	361	302	302	365	FSG	-	6SL32 0- YE52- A 0
250	400	477	477	370	361	471	FSG	-	6SL32 0- YE54- A 0
315	400	570	477	468	390	585	FSH	-	6SL32 2 0- YE56- C 0
355	450	640	515	491	394	654	FSH	-	6SL32 2 0- YE58- C 0
400	500	720	590	551	452	735	FSH	-	6SL32 2 0- YE60- C 0
450	500	820	663	672	542	850	FSJ	-	6SL32 2 0- YE62- C 0
500	600	890	724	728	591	924	FSJ	-	6SL32 2 0- YE64- C 0
560	700	1000	830	786	652	1038	FSJ	-	6SL32 2 0- YE66- C 0

#### Article No. supplements

Environmental class/harmful chemical substances acc. to IEC 60721-3-3: 2002

Class 3C2 – **delivery ex stock**

Class 3C3 \*

#### Operator Panel

Without Operator Panel \*

With BOP-2 Basic Operator Panel (numeric 2-line display) \*

With IOP-2 Intelligent Operator Panel (graphic color display) – **delivery ex stock**

#### Extension with SINAMICS G120X I/O Extension Module

Without extension – **delivery ex stock**

With SINAMICS G120X I/O Extension Module \* **NEW**

#### Line filter

Without integrated line filter – **delivery ex stock**

With integrated line filter Category C2 – **delivery ex stock**

With integrated line filter Category C3 \*

#### Communication

USS, Modbus RTU, BACnet MS/TP \*

PROFINET, EtherNet/IP – **delivery ex stock**

PROFIBUS DP \*

\* If you select one of these supplements, the delivery time for converters up to 132 kW will change from "delivery ex stock" to "standard delivery time".

<sup>1)</sup> Rated power based on the base-load current  $I_L$ . The base-load current  $I_L$  is based on the duty cycle for low overload (LO).

<sup>2)</sup> The rated output current is based on the duty cycle for low overload (LO). These current values are valid for 400 V or 480 V.

<sup>3)</sup> The base-load current  $I_{H1}$  is based on the duty cycle for high overload (HO). These current values are valid for 400 V or 480 V.

<sup>4)</sup> The input current depends on the motor load and line impedance. The input currents apply for a load at rated power (based on  $I_L$ ) for a line impedance corresponding to  $u_k = 1\%$ . The current values are specified on the rating plate of the converter.



Clicking to the Industry Mall

# SINAMICS G120X infrastructure converters for HVAC/Water/Wastewater

0.75 kW to 630 kW (1 hp to 700 hp)

6SL3255-0AA00-5AA0



## SINAMICS G120X infrastructure converters for HVAC/Water/Wastewater

### Load-side power components (Configuration with line-side components see double page before)

Output reactors	Sine-wave filters When using sine-wave filters, please note for the pulse frequency of the converter: • ≤ 90 kW: 4 kHz up to 8 kHz • ≥ 110 kW: 4 kHz	dv/dt filters plus VPL The prefix "JTA:" is part of a Siemens internal order code that does not belong to the product number of the original manufacturer.
Article No.	Article No.	Article No.
-	6SL3202-0AE20-3SA0	-
-	6SL3202-0AE20-6SA0	-
-	-	-
-	6SL3202-0AE21-1SA0	-
-	-	-
-	6SL3202-0AE21-4SA0	-
-	6SL3202-0AE22-0SA0	-
-	-	-
-	6SL3202-0AE23-3SA0	-
-	-	-
6SL3202-0AE23-8CA0	6SL3202-0AE24-6SA0	JTA:TEF1203-0HB
6SE6400-3TC07-5ED0	-	JTA:TEF1203-0JB
-	6SL3202-0AE26-2SA0	-
-	6SL3202-0AE28-8SA0	JTA:TEF1203-0KB
6SE6400-3TC14-5FD0	-	-
-	6SL3202-0AE31-5SA0	JTA:TEF1203-0LB
-	6SL3202-0AE31-8SA0	JTA:TEF1203-0MB
6SL3000-2BE32-1AA0	6SL3000-2CE32-3AA0 <sup>1)</sup>	-
6SL3000-2BE32-6AA0	-	-
6SL3000-2BE33-2AA0	6SL3000-2CE32-8AA0 <sup>1)2)</sup>	6SL3000-2DE35-0AA0
6SL3000-2BE33-8AA0	6SL3000-2CE33-3AA0 <sup>1)2)</sup>	-
6SL3000-2BE35-0AA0	6SL3000-2CE34-1AA0 <sup>1)2)</sup>	-
6SL3000-2AE36-1AA0	-	6SL3000-2DE38-4AA0
6SL3000-2AE38-4AA0	-	-
-	-	-
6SL3000-2AE41-0AA0	-	6SL3000-2DE41-4AA0
-	-	-
6SL3000-2AE41-4AA0	-	-

### Ordering examples

Basic selection

SINAMICS G120X converters · degree of protection IP20/UL Open Type · 380 ... 480 V 3 AC, 15 kW · with integrated line filter – converters up to 132 kW delivery ex stock

Article No. supplements

Environmental class/harmful chemical substances acc. to IEC 60721-3-3: 2002

Class 3C2 – delivery ex stock

Class 3C3 \*

Operator Panel

With BOP-2 Basic Operator Panel (numeric 2-line display) \*

With IOP-2 Intelligent Operator Panel (graphic color display) – delivery ex stock

Extension with SINAMICS G120X I/O Extension Module

Without extension – delivery ex stock

With SINAMICS G120X I/O Extension Module \*

Line filter

With integrated line filter Category C2 – delivery ex stock

Communication

USS, Modbus RTU, BACnet MS/TP \*

PROFINET, EtherNet/IP – delivery ex stock

PROFIBUS DP \*

Complete Article No.

Example 1	Example 2
6SL32 2 0- 3 YE28- 0 A F 0	6SL32 3 0- 2 YE28- 0 A F 0

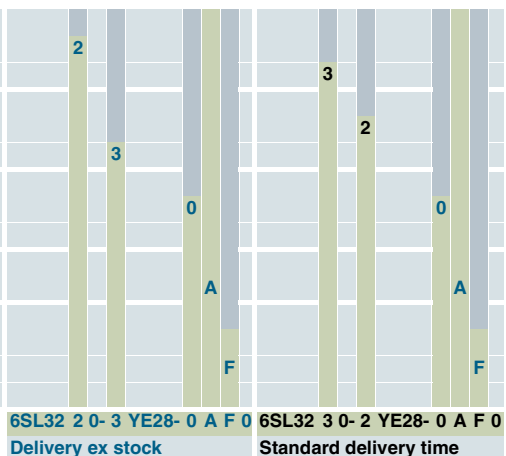

\* If you select one of these supplements, the delivery time for converters up to 132 kW will change from "delivery ex stock" to "standard delivery time".

<sup>1)</sup> For converters with a rated power ≥ 110 kW, around 70 % of the current and power is still available when using sine-wave filters due to current derating of the converter.

<sup>2)</sup> For 160 kW, 200 kW and 250 kW, only operation in Vector Control is permitted. V/f must not be used.



# SINAMICS G120X infrastructure converters for HVAC/Water/Wastewater

0.75 kW to 630 kW (1 hp to 700 hp)

Clicking to the Industry Mall

6SL3255-0AA00-5AA0



## SINAMICS G120X infrastructure converters for HVAC/Water/Wastewater

### Selection and ordering data

SINAMICS G120X converters · Degree of protection IP20/UL Open Type · 500 ... 690 V 3 AC → Configuration with line-side components (see right page)

Rated power <sup>1)</sup>		Rated output current <sup>2)</sup>		Base-load current $I_H$ <sup>3)</sup>		Rated input current <sup>4)</sup>	Frame size	SINAMICS G120X Degree of protection IP20/UL Open Type without integrated line filter	SINAMICS G120X Degree of protection IP20/UL Open Type with integrated line filter
690 V kW	600 V hp	690 V A	600 V A	690 V A	600 V A	690 V A		Article No.	Article No.
<b>500 ... 690 V 3 AC · Rated pulse frequency 2 kHz · Input frequency 47 ... 63 Hz</b>									
3	4	5	5	4	4	5	FSD	6SL32 0- YH18- U 0	6SL32 0- YH18- A 0
4	5	6.3	6.3	5	5	6	FSD	6SL32 0- YH20- U 0	6SL32 0- YH20- A 0
5.5	7.5	9	9	6.3	6.3	9	FSD	6SL32 0- YH22- U 0	6SL32 0- YH22- A 0
7.5	10	11	11	9	9	11	FSD	6SL32 0- YH24- U 0	6SL32 0- YH24- A 0
11	10	14	14	11	11	14	FSD	6SL32 0- YH26- U 0	6SL32 0- YH26- A 0
15	15	19	19	14	14	18	FSD	6SL32 0- YH28- U 0	6SL32 0- YH28- A 0
18.5	20	23	23	19	19	22	FSD	6SL32 0- YH30- U 0	6SL32 0- YH30- A 0
22	25	27	27	23	23	25	FSD	6SL32 0- YH32- U 0	6SL32 0- YH32- A 0
30	30	35	35	27	27	33	FSD	6SL32 0- YH34- U 0	6SL32 0- YH34- A 0
37	40	42	42	35	35	40	FSD	6SL32 0- YH36- U 0	6SL32 0- YH36- A 0
45	50	52	52	42	42	50	FSE	6SL32 0- YH38- U 0	6SL32 0- YH38- A 0
55	60	62	62	52	52	59	FSE	6SL32 0- YH40- U 0	6SL32 0- YH40- A 0
75	75	80	80	62	62	78	FSF	6SL32 0- YH42- U 0	6SL32 0- YH42- C 0
90	100	100	100	80	80	97	FSF	6SL32 0- YH44- U 0	6SL32 0- YH44- C 0
110	125	125	125	100	100	121	FSF	6SL32 0- YH46- U 0	6SL32 0- YH46- C 0
132	150	144	144	125	125	138	FSF	6SL32 0- YH48- U 0	6SL32 0- YH48- C 0
160	150	171	171	144	144	171	FSG <sup>5)</sup>	-	6SL32 0- YH50- C 0
200	200	208	208	171	171	205	FSG <sup>5)</sup>	-	6SL32 0- YH52- C 0
250	250	250	250	208	208	249	FSG <sup>5)</sup>	-	6SL32 0- YH54- C 0
315	350	330	345	272	282	343	FSH	-	6SL32 2 0- YH56- C 0
355	400	385	388	314	317	401	FSH	-	6SL32 2 0- YH58- C 0
400	450	420	432	348	357	437	FSH	-	6SL32 2 0- YH60- C 0
450	500	470	487	394	408	489	FSH	-	6SL32 2 0- YH62- C 0
500	500	520	546	444	462	540	FSJ	-	6SL32 2 0- YH64- C 0
560	600	580	610	476	498	602	FSJ	-	6SL32 2 0- YH66- C 0
630	700	650	679	532	554	675	FSJ	-	6SL32 2 0- YH68- C 0

#### Article No. supplements

**Environmental class/harmful chemical substances** acc. to IEC 60721-3-3: 2002

Class 3C2

Class 3C3

#### Operator Panel

Without Operator Panel

With BOP-2 Basic Operator Panel (numeric 2-line display)

With IOP-2 Intelligent Operator Panel (graphic color display)

#### Extension with SINAMICS G120X I/O Extension Module

Without extension

With SINAMICS G120X I/O Extension Module

#### Line filter

Without integrated line filter

With integrated line filter Category C2

With integrated line filter Category C3

#### Communication

USS, Modbus RTU, BACnet MS/TP

PROFINET, EtherNet/IP

PROFIBUS DP

<sup>1)</sup> Rated power based on the base-load current  $I_L$ . The base-load current  $I_L$  is based on the duty cycle for low overload (LO).

<sup>2)</sup> The rated output current is based on the duty cycle for low overload (LO). These current values are valid for 690 V or 600 V.

<sup>3)</sup> The base-load current  $I_H$  is based on the duty cycle for high overload (HO). These current values are valid for 690 V or 600 V.

<sup>4)</sup> The input current depends on the motor load and line impedance. The input currents apply for a load at rated power (based on  $I_L$ ) for a line impedance corresponding to  $u_k = 1\%$ . The current values are specified on the rating plate of the converter.

<sup>5)</sup> The 690 V versions of frame size FSG are only available with an integrated line filter Category C3. To operate the converters also within TN systems with grounded outer conductor, you must remove the grounding screw.

Clicking to the Industry Mall

6SL3255-0AA00-5AA0



# SINAMICS G120X infrastructure converters for HVAC/Water/Wastewater

0.75 kW to 630 kW (1 hp to 700 hp)

## SINAMICS G120X infrastructure converters for HVAC/Water/Wastewater

**Line-side components** (Configuration with load-side power components see next double page)

Line filters	Category C1	Line reactors	Recommended line-side overcurrent protection devices <sup>1)</sup>			
			Fuses IEC-compliant		Fuses UL/cUL-compliant	
Category C2		For frame sizes FSH and FSJ mandatory when using an external line filter Category C2			Rated voltage 600 V AC <sup>2)</sup>	
	Article No.	Article No.	Current A	Article No.	Fuse type Class/Article No.	Current A
SINAMICS G120X available with integrated line filter Category C2	-	A DC link reactor is integrated for frame sizes FSA to FSG – therefore no line reactor is required.	16	<b>3NA3805-6</b>	J	8
	-		16	<b>3NA3805-6</b>	J	10
	-		16	<b>3NA3805-6</b>	J	15
	-		16	<b>3NA3805-6</b>	J	15
	-		20	<b>3NA3807-6</b>	J	20
	-		25	<b>3NA3810-6</b>	J	25
	-		32	<b>3NA3812-6</b>	J	30
	-		40	<b>3NA3817-6KJ</b>	J	35
	-		50	<b>3NA3820-6KJ</b>	J	50
	-		63	<b>3NA3822-6</b>	J	60
	-		80	<b>3NA3824-6</b>	J	80
	-		80	<b>3NA3824-6</b>	J	80
	-		100	<b>3NA3830-6</b>	J	110
	-		125	<b>3NA3132-6</b>	J	150
	-		160	<b>3NA3136-6</b>	J	150
-		200	<b>3NA3140-6</b>	J	200	
-		250	<b>3NE1227-0</b>		250	
-		315	<b>3NE1230-0</b>		315	
-		350	<b>3NE1331-0</b>		350	
<b>6SL3760-0MS00-0AA0</b>	-	<b>6SL3000-0CH34-8AA0</b>	450	<b>3NE1333-2</b>		450
	-		500	<b>3NE1334-2</b>		500
	-		560	<b>3NE1435-2</b>		560
	-	<b>6SL3000-0CH36-0AA0</b>	630	<b>3NE1436-2</b>		630
	-		710	<b>3NE1437-2</b>		710
	-	<b>6SL3000-0CH38-4AA0</b>	800	<b>3NE1438-2</b>		800
	-		850	<b>3NE1448-2</b>		850

2

<sup>1)</sup> Further information at <https://support.industry.siemens.com/cs/document/109762895>

<sup>2)</sup> The Short Circuit Current Rating (SCCR) according to UL for industrial control panel installations to NEC Article 409 or UL 508A/508C or UL 61800-5-1 is 100 kA for SINAMICS G120X.

# SINAMICS G120X infrastructure converters for HVAC/Water/Wastewater

0.75 kW to 630 kW (1 hp to 700 hp)

[Clicking to the Industry Mall](#)

**6SL3255-0AA00-5AA0**



## SINAMICS G120X infrastructure converters for HVAC/Water/Wastewater

### Selection and ordering data

**SINAMICS G120X converters · Degree of protection IP20/UL Open Type · 500 ... 690 V 3 AC ⇒ Configuration with load-side power components (see right page)**

Rated power <sup>1)</sup>		Rated output current <sup>2)</sup>		Base-load current $I_H$ <sup>3)</sup>		Rated input current <sup>4)</sup>	Frame size	SINAMICS G120X Degree of protection IP20/UL Open Type without integrated line filter	SINAMICS G120X Degree of protection IP20/UL Open Type with integrated line filter
690 V kW	600 V hp	690 V A	600 V A	690 V A	600 V A				
<b>500 ... 690 V 3 AC · Rated pulse frequency 2 kHz · Input frequency 47 ... 63 Hz</b>									
<b>3</b>	4	5	5	4	4	5	FSD	<b>6SL32 0- YH18- U 0</b>	<b>6SL32 0- YH18- A 0</b>
<b>4</b>	5	6.3	6.3	5	5	6	FSD	<b>6SL32 0- YH20- U 0</b>	<b>6SL32 0- YH20- A 0</b>
<b>5.5</b>	7.5	9	9	6.3	6.3	9	FSD	<b>6SL32 0- YH22- U 0</b>	<b>6SL32 0- YH22- A 0</b>
<b>7.5</b>	10	11	11	9	9	11	FSD	<b>6SL32 0- YH24- U 0</b>	<b>6SL32 0- YH24- A 0</b>
<b>11</b>	10	14	14	11	11	14	FSD	<b>6SL32 0- YH26- U 0</b>	<b>6SL32 0- YH26- A 0</b>
<b>15</b>	15	19	19	14	14	18	FSD	<b>6SL32 0- YH28- U 0</b>	<b>6SL32 0- YH28- A 0</b>
<b>18.5</b>	20	23	23	19	19	22	FSD	<b>6SL32 0- YH30- U 0</b>	<b>6SL32 0- YH30- A 0</b>
<b>22</b>	25	27	27	23	23	25	FSD	<b>6SL32 0- YH32- U 0</b>	<b>6SL32 0- YH32- A 0</b>
<b>30</b>	30	35	35	27	27	33	FSD	<b>6SL32 0- YH34- U 0</b>	<b>6SL32 0- YH34- A 0</b>
<b>37</b>	40	42	42	35	35	40	FSD	<b>6SL32 0- YH36- U 0</b>	<b>6SL32 0- YH36- A 0</b>
<b>45</b>	50	52	52	42	42	50	FSE	<b>6SL32 0- YH38- U 0</b>	<b>6SL32 0- YH38- A 0</b>
<b>55</b>	60	62	62	52	52	59	FSE	<b>6SL32 0- YH40- U 0</b>	<b>6SL32 0- YH40- A 0</b>
<b>75</b>	75	80	80	62	62	78	FSF	<b>6SL32 0- YH42- U 0</b>	<b>6SL32 0- YH42- A 0</b>
<b>90</b>	100	100	100	80	80	97	FSF	<b>6SL32 0- YH44- U 0</b>	<b>6SL32 0- YH44- C 0</b>
<b>110</b>	125	125	125	100	100	121	FSF	<b>6SL32 0- YH46- U 0</b>	<b>6SL32 0- YH46- C 0</b>
<b>132</b>	150	144	144	125	125	138	FSF	<b>6SL32 0- YH48- U 0</b>	<b>6SL32 0- YH48- C 0</b>
<b>160</b>	150	171	171	144	144	171	FSG <sup>5)</sup>	-	<b>6SL32 0- YH50- C 0</b>
<b>200</b>	200	208	208	171	171	205	FSG <sup>5)</sup>	-	<b>6SL32 0- YH52- C 0</b>
<b>250</b>	250	250	250	208	208	249	FSG <sup>5)</sup>	-	<b>6SL32 0- YH54- C 0</b>
<b>315</b>	350	330	345	272	282	343	FSH	-	<b>6SL32 2 0- YH56- C 0</b>
<b>355</b>	400	385	388	314	317	401	FSH	-	<b>6SL32 2 0- YH58- C 0</b>
<b>400</b>	450	420	432	348	357	437	FSH	-	<b>6SL32 2 0- YH60- C 0</b>
<b>450</b>	500	470	487	394	408	489	FSH	-	<b>6SL32 2 0- YH62- C 0</b>
<b>500</b>	500	520	546	444	462	540	FSJ	-	<b>6SL32 2 0- YH64- C 0</b>
<b>560</b>	600	580	610	476	498	602	FSJ	-	<b>6SL32 2 0- YH66- C 0</b>
<b>630</b>	700	650	679	532	554	675	FSJ	-	<b>6SL32 2 0- YH68- C 0</b>

#### Article No. supplements

**Environmental class/harmful chemical substances** acc. to IEC 60721-3-3: 2002

Class 3C2

Class 3C3

#### Operator Panel

Without Operator Panel

With BOP-2 Basic Operator Panel (numeric 2-line display)

With IOP-2 Intelligent Operator Panel (graphic color display)

#### Extension with SINAMICS G120X I/O Extension Module

Without extension

With SINAMICS G120X I/O Extension Module

#### Line filter

Without integrated line filter

With integrated line filter Category C2

With integrated line filter Category C3

#### Communication

USS, Modbus RTU, BACnet MS/TP

PROFINET, EtherNet/IP

PROFIBUS DP

<sup>1)</sup> Rated power based on the base-load current  $I_L$ . The base-load current  $I_L$  is based on the duty cycle for low overload (LO).

<sup>2)</sup> The rated output current is based on the duty cycle for low overload (LO). These current values are valid for 690 V or 600 V.

<sup>3)</sup> The base-load current  $I_H$  is based on the duty cycle for high overload (HO). These current values are valid for 690 V or 600 V.

<sup>4)</sup> The input current depends on the motor load and line impedance. The input currents apply for a load at rated power (based on  $I_L$ ) for a line impedance corresponding to  $u_k = 1\%$ . The current values are specified on the rating plate of the converter.

<sup>5)</sup> The 690 V versions of frame size FSG are only available with an integrated line filter Category C3. To operate the converters also within TN systems with grounded outer conductor, you must remove the grounding screw.



# SINAMICS G120X infrastructure converters for HVAC/Water/Wastewater

0.75 kW to 630 kW (1 hp to 700 hp)

## SINAMICS G120X infrastructure converters for HVAC/Water/Wastewater

### Load-side power components (Configuration with line-side components see double page before)

<b>Output reactors</b> The prefix "JTA:" is part of a Siemens internal order code that does not belong to the product number of the original manufacturer.	<b>Sine-wave filters</b>	<b>dv/dt filters plus VPL</b> The prefix "JTA:" is part of a Siemens internal order code that does not belong to the product number of the original manufacturer.	
Article No.	Article No.	Article No.	
JTA:TEU2532-0FP00-4EA0	-	JTA:TEF1203-0GB	
	-		
	-		
	-		
	-		
	-		
	-		
	-		
	-		
	-		
	-		
	-		
	-		
	-		
	-		
	-		
	-		

# SINAMICS G120X infrastructure converters for HVAC/Water/Wastewater

0.75 kW to 630 kW (1 hp to 700 hp)

Clicking to the Industry Mall

6SL3255-0AA00-5AA0

## SINAMICS G120X infrastructure converters for HVAC/Water/Wastewater



### Selection and ordering data

#### Supplementary system components for SINAMICS G120X

Description	Article No.
<b>IOP-2 Intelligent Operator Panel</b> Operating languages: English, German, French, Italian, Spanish, Portuguese, Dutch, Swedish, Finnish, Russian, Czech, Polish, Turkish, Chinese Simplified	<b>6SL3255-0AA00-4JA2</b>
<b>IOP-2 Handheld</b>	<b>6SL3255-0AA00-4HA1</b>
<b>BOP-2 Basic Operator Panel</b>	<b>6SL3255-0AA00-4CA1</b>
<b>Door mounting kit</b> for IOP-2/BOP-2	<b>6SL3256-0AP00-0JA0</b>
<b>SINAMICS SD card</b> 512 MB, empty	<b>6SL3054-4AG00-2AA0</b>
<b>SINAMICS G120 Smart Access</b> for wireless commissioning, operation and diagnostics of the following converters using a smartphone, tablet or laptop	<b>6SL3255-0AA00-5AA0</b>
<b>SINAMICS CONNECT 300 IoT Gateway</b> <b>NEW</b> for connecting up to eight converters to the Cloud MindSphere	<b>6SL3255-0AG30-0AA0</b>
<b>SINAMICS G120X I/O Extension Module</b> <b>NEW</b> for direct connection of Pt1000/Ni1000 temperature sensors <sup>1)</sup>	<b>6SL3255-0BE00-0AA0</b>
<b>Shield connection kits for Power Module</b> for SINAMICS G120X • Frame sizes FSA to FSG  • Frame sizes FSH to FSJ	Included in the scope of delivery of the converters, can be ordered as spare part Please observe the notes included in the operating instructions
<b>Push-through mounting frames</b> for SINAMICS G120X • Frame size FSA • Frame size FSB • Frame size FSC • Frame size FSD • Frame size FSE • Frame size FSF • Frame size FSG	<b>6SL3261-6GA00-0BA0</b> <b>6SL3261-6GB00-0BA0</b> <b>6SL3261-6GC00-0BA0</b> <b>6SL3261-6GD00-0BA0</b> <b>6SL3261-6GE00-0BA0</b> <b>6SL3261-6GF00-0BA0</b> <b>6SL3261-6GG00-0BA0</b>
<b>Installation handles</b> for SINAMICS G120X • Frame sizes FSD to FSF	<b>6SL3200-0SM22-0AA0</b>
<b>IP21 top covers</b> for SINAMICS G120X • Frame size FSA • Frame size FSB • Frame sizes FSC and FSD • Frame size FSE • Frame sizes FSF and FSG	<b>6SL3266-1PA00-0BA0</b> <b>6SL3266-1PB00-0BA0</b> <b>6SL3266-1PD00-0BA0</b> <b>6SL3266-1PE00-0BA0</b> <b>6SL3266-1PF00-0BA0</b>
<b>Wiring adapter</b> <b>NEW</b> for optimal and space-saving wiring for SINAMICS G120X • Frame size FSG	<b>6SL3266-2HG00-0BA0</b>
<b>Installation kit for line-side cable connection, left</b> for SINAMICS G120X • Frame size FSH	<b>6SL3366-1LH00-0PA0</b>
<b>SINAMICS G120X Starter Kits</b> Converter (380 ... 480 V 3 AC, PROFINET) with IOP-2 and SINAMICS G120 Smart Access • 0.75 kW, FSA, without integrated line filter • 0.75 kW, FSA, with integrated line filter Category C2 • 3 kW, FSA, with integrated line filter Category C2 • 7.5 kW, FSB, with integrated line filter Category C2	<b>6SL3200-0AE70-0AA0</b> <b>6SL3200-0AE72-0AA0</b> <b>6SL3200-0AE73-0AA0</b> <b>6SL3200-0AE74-0AA0</b>
<b>SINAMICS G120X training case</b>	<b>6AG1067-2AA00-0AC1</b>

#### Spare parts for SINAMICS G120X

Description	Article No.
<b>FPI board (freely-programmable interface board)</b> for SINAMICS G120X • Frame sizes FSH and FSJ	<b>6SL3200-0SP05-0AA0</b>
<b>PSB board (power supply board)</b> for SINAMICS G120X • Frame sizes FSH and FSJ	<b>6SL3200-0SP06-0AA0</b>
<b>Current transformers</b> for SINAMICS G120X • 2000 A for frame size FSJ • 1000 A for frame sizes FSH and FSJ	<b>6SL3200-0SE01-0AA0</b> <b>6SL3200-0SE02-0AA0</b>
<b>Spare parts kit for Control Unit</b> for SINAMICS G120X • Frame sizes FSA to FSJ	<b>6SL3200-0SK10-0AA0</b>
<b>Shield connection kit for Control Unit</b> for SINAMICS G120X • Frame sizes FSD to FSG	<b>6SL3264-1EA00-0YA0</b>
<b>Shield connection kits for Power Module</b> for SINAMICS G120X • Frame size FSA • Frame size FSB • Frame size FSC • Frame size FSD • Frame size FSE • Frame size FSF • Frame size FSG	<b>6SL3262-1AA01-0DA0</b> <b>6SL3262-1AB01-0DA0</b> <b>6SL3262-1AC01-0DA0</b> <b>6SL3262-1AD01-0DA0</b> <b>6SL3262-1AE01-0DA0</b> <b>6SL3262-1AF01-0DA0</b> <b>6SL3262-1AG01-0DA0</b>
<b>Small parts assembly set</b> for SINAMICS G120X • Frame sizes FSD to FSG	<b>6SL3200-0SK08-0AA0</b>
<b>Terminal cover kits</b> for SINAMICS G120X • Frame size FSD • Frame size FSE • Frame size FSF • Frame size FSG	<b>6SL3200-0SM13-0AA0</b> <b>6SL3200-0SM14-0AA0</b> <b>6SL3200-0SM15-0AA0</b> <b>6SL3200-0SM16-0AA0</b>
<b>External fan units</b> for SINAMICS G120X • Frame size FSA • Frame size FSB • Frame size FSC • Frame size FSD • Frame size FSE • Frame size FSF • Frame size FSG • Frame sizes FSH and FSJ	<b>6SL3200-0SF52-0AA0</b> <b>6SL3200-0SF53-0AA0</b> <b>6SL3200-0SF54-0AA0</b> <b>6SL3200-0SF15-0AA0</b> <b>6SL3200-0SF16-0AA0</b> <b>6SL3200-0SF17-0AA0</b> <b>6SL3200-0SF18-0AA0</b> <b>6SL3300-0SF01-0AA0</b>
<b>Internal fan unit</b> for SINAMICS G120X • Frame sizes FSH and FSJ	<b>6SL3200-0SF50-0AA0</b>
<b>Control Units</b> for SINAMICS G120X frame sizes FSD to FSJ • USS, Modbus RTU, BACnet MS/TP • PROFINET, EtherNet/IP • PROFIBUS DP	<b>6SL3200-0SC10-0BA0</b> <b>6SL3200-0SC10-0FA0</b> <b>6SL3200-0SC10-0PA0</b>

**Compact Installation Instructions** are supplied in hard copy form in German and English with every SINAMICS G120X.

Further technical specifications and documentation are available on the internet at:

[www.siemens.com/sinamics-g120x/documentation](http://www.siemens.com/sinamics-g120x/documentation)  
and via the Drive Technology Configurator (DT Configurator) in the Siemens Industry Mall:  
[www.siemens.com/dt-configurator](http://www.siemens.com/dt-configurator)

<sup>1)</sup> The SINAMICS G120X I/O Extension Module (article number: 6SL3255-0BE00-0AA0) is only supported on the SINAMICS G120X converters with FS code<sup>3</sup> 02 02 (FSA to FSG) / 02 (FSH/FSJ) and firmware  $\geq$  V1.01.  
The FS code version of the converter is on the rating plate.  
For more information please refer to the documentation on the internet at:  
[www.siemens.com/sinamics-g120x/documentation](http://www.siemens.com/sinamics-g120x/documentation)

# SINAMICS G120X infrastructure converters for HVAC/Water/Wastewater

0.75 kW to 630 kW (1 hp to 700 hp)

## SINAMICS G120X infrastructure converters for HVAC/Water/Wastewater

### Technical specifications

Unless explicitly specified otherwise, the following technical specifications are valid for all SINAMICS G120X converters.

General technical specifications	
<b>Mechanical specifications</b>	
<b>Shock and vibration load</b>	
<ul style="list-style-type: none"> <li>Frame sizes FSA to FSG               <ul style="list-style-type: none"> <li>Transport in transport packaging acc. to EN 61800-5-1 and EN 60068-2-6</li> <li>Vibration during operation acc. to IEC 60721-3-3: 2002</li> </ul> </li> <li>Frame sizes FSH and FSJ               <ul style="list-style-type: none"> <li>Vibration in transport packaging: Test Fc acc. to EN 60068-2-64</li> <li>Shock in product packaging: Test Fc acc. to EN 60068-2-6</li> <li>Vibration during operation: Test Fc acc. to EN 60068-2-6</li> <li>Shock during operation: Test acc. to EN 60068-2-27</li> </ul> </li> </ul>	Class 2M3  Class 3M1  ±1.5 mm for 5 ... 9 Hz 0.5 × g at 9 ... 200 Hz  ±1.5 mm for 5 ... 9 Hz 0.5 × g at 9 ... 200 Hz  0.075 mm at 10 ... 58 Hz 9.81 m/s <sup>2</sup> (1 × g) at > 58 ... 200 Hz  Shock type EA 49 m/s <sup>2</sup> (5 × g)/30 ms 147 m/s <sup>2</sup> (15 × g)/11 ms
<b>Degree of protection</b>	
<ul style="list-style-type: none"> <li>Frame sizes FSA ... FSJ</li> <li>Frame sizes FSA ... FSG</li> </ul>	IP20/ UL Open Type Optional IP21/ UL Open Type with IP21 top covers
<b>Permissible mounting position</b>	Vertical wall mounting
<b>Ambient conditions</b>	
<b>Protection class</b> According to EN 61800-5-1	Class III (PELV1) for Power Module Class III (PELV1) for Control Unit <sup>1)</sup>
<b>Touch protection</b> According to EN 61800-5-1	Class I (with protective conductor system)
<b>Humidity, max.</b>	<95 % at 40 °C (104 °F), condensation and icing not permissible
<b>Ambient temperature</b>	
<ul style="list-style-type: none"> <li>Storage acc. to EN 60068-2-1               <ul style="list-style-type: none"> <li>Frame sizes FSA to FSG</li> <li>Frame sizes FSH and FSJ</li> </ul> </li> <li>Transport acc. to EN 60068-2-1</li> <li>Operation acc. to EN 60068-2-2               <ul style="list-style-type: none"> <li>Frame sizes FSA to FSG</li> </ul> </li> <li>Frame sizes FSH and FSJ</li> <li>All frame sizes with operator panel</li> </ul>	-40 ... +70 °C (-40 ... +158 °F) -25 ... +55 °C (-13 ... +131 °F) -40 ... +70 °C (-40 ... +158 °F)  Variant PROFINET, EthernNet/IP: -20 °C ... +55 °C (-4 ... +131 °F) with a side clearance of 5 cm or -20 °C ... +50 °C (-4 ... +122 °F) for side-by-side mounting, >45 °C (113 °F) with derating Variants PROFIBUS DP and USS, Modbus RTU, BACnet MS/TP: -20 °C ... +60 °C (-4 ... +140 °F) with a side clearance of 5 cm or -20 °C ... +50 °C (-4 ... +122 °F) for side-by-side mounting, >45 °C (113 °F) with derating 0 ... 55 °C (32 ... 131 °F), >45 °C (113 °F) with derating 0 ... 50 °C (32 ... 122 °F) <a href="#">see also derating characteristics</a>
<b>Environmental class in operation</b>	
<ul style="list-style-type: none"> <li>Harmful chemical substances               <ul style="list-style-type: none"> <li>Frame sizes FSA to FSG</li> <li>Frame sizes FSH and FSJ</li> </ul> </li> <li>Organic/biological pollutants</li> <li>Degree of pollution</li> </ul>	Class 3C2 acc. to IEC 60721-3-3: 2002 Optional: Class 3C3 acc. to IEC 60721-3-3: 2002 <sup>2)</sup>  Class 3C2 acc. to IEC 60721-3-3: 2002  Class 3B1 acc. to IEC 60721-3-3: 2002  2 acc. to EN 61800

<sup>1)</sup> Only supported for SINAMICS G120X converters with FS code ≥ 02 02 (FSA to FSG) / 02 (FSH/FSJ).  
The FS code of the converter is on the rating plate.

<sup>2)</sup> Only supported for SINAMICS G120X converters with FS code ≥ 02 02.  
The FS code of the converter is on the rating plate.

## SINAMICS G120X infrastructure converters for HVAC/Water/Wastewater

0.75 kW to 630 kW (1 hp to 700 hp)

### SINAMICS G120X infrastructure converters for HVAC/Water/Wastewater

#### Technical specifications

##### General technical specifications (continued)

##### Standards

##### Compliance with standards <sup>1)</sup>

- |                           |  |
|---------------------------|--|
| • Frame sizes FSA to FSG  | CE, UL, cUL, RCM, SEMI F47, RoHS II, EAC, KCC, REACH |
| • Frame sizes FSH and FSJ | CE, UL, cUL, RCM, SEMI F47, RoHS II, EAC, REACH      |

##### Fail-safe certification

- |                               |  |
|-------------------------------|--|
|                               | Function: Safe Torque Off (STO)<br>External components (e.g. safety relays) are necessary for using the STO safety function. |
| • According to IEC 61508      | SIL 3  |
| • According to EN ISO 13849-1 | PL e and Category 3  |

##### CE marking, according to

- |  |  |
|--|--|
|  | EMC Directive 2014/30/EU<br>Low Voltage Directive 2014/35/EU |
|--|--|

##### EMC Directive <sup>1)</sup>

acc. to EN 61800-3

- |   |   |
|---|---|
| • Interference immunity   | The SINAMICS G120X converters are tested according to the interference immunity requirements for environments according to Category C3. |
| • Interference emissions  |   |
| - Frame sizes FSA to FSF without integrated line filter   | 2)  |
| - Frame sizes FSA to FSG with integrated line filter Category C2  | Observance of the limit values according for conducted RF emissions according to IEC 61800-3 Category C2 / EN 55011:2016 Class A        |
| - Frame sizes FSG to FSJ with integrated line filter Category C3  | Observance of the limit values according for conducted RF emissions according to IEC 61800-3 Category C3                                |
| - Frame sizes FSH and FSJ with integrated line filter Category C3 with optional line filter Category C2 and optional line reactor | Observance of the limit values according for conducted RF emissions according to IEC 61800-3 Category C2 / EN 55011:2016 Class A        |
| - Frame sizes FSA to FSF ≤ 90 kW without integrated line filter with optional line filter Category C1                             | Observance of the limit values according for conducted RF emissions according to IEC 61800-3 Category C1 / EN 55011:2016 Class B        |
| - Frame size FSF 110 kW with integrated line filter Category C2 with optional line filter Category C1                             | Observance of the limit values according for conducted RF emissions according to IEC 61800-3 Category C1 / EN 55011:2016 Class B        |

##### Note:

The EMC product standard EN 61800-3 does not apply directly to a frequency converter but to a PDS (Power Drive System), which comprises the complete circuitry, motor and cables in addition to the converter. The frequency converters on their own do not generally require identification according to the EMC Directive.

<sup>1)</sup> Additional information is available in the operating instructions on the internet at: [www.siemens.com/sinamics-g120x/documentation](http://www.siemens.com/sinamics-g120x/documentation)

<sup>2)</sup> Non-filtered devices are designed for operation in IT systems or in conjunction with an RCD. The customer must provide suitable RI suppression equipment to ensure that these devices comply with the limits defined for Category C3.



# SINAMICS G120X infrastructure converters for HVAC/Water/Wastewater

0.75 kW to 630 kW (1 hp to 700 hp)

## SINAMICS G120X infrastructure converters for HVAC/Water/Wastewater

### Technical specifications

SINAMICS G120X converters			
Integrated bus interface	Variant PROFINET, EtherNet/IP	Variant PROFIBUS DP	Variant USS, Modbus RTU, BACnet MS/TP
<b>Fieldbus protocols</b>	<ul style="list-style-type: none"> <li>PROFINET</li> <li>EtherNet/IP</li> </ul>	<ul style="list-style-type: none"> <li>PROFIBUS DP</li> </ul>	<ul style="list-style-type: none"> <li>USS</li> <li>Modbus RTU</li> <li>BACnet MS/TP</li> </ul>
<b>Hardware</b>	2 × RJ45, device name can be stored on the device, max. 100 Mbit/s (full duplex)	9-pin SUB-D socket, isolated, max. 12 Mbit/s	RS485 connected at a terminal, isolated, bus terminating resistor can be switched in, USS: max. 187.5 kBaud Modbus RTU: 19.2 kBaud BACnet MS/TP: max. 187.5 kBaud
I/O interfaces			
<b>Signal cable cross-section</b>	0.15 ... 1.5 mm <sup>2</sup> (28 ... 16 AWG)		
<b>Digital inputs – standard</b>	6 isolated inputs Optically isolated; Free reference potential (own potential group) NPN/PNP logic can be selected using the wiring		
<ul style="list-style-type: none"> <li>Switching level: 0 → 1</li> <li>Switching level: 1 → 0</li> </ul>	11 V 5 V		
<b>Digital inputs – fail-safe</b>	1 isolated input Max. input voltage 60 V Safety function: Safe Torque Off (STO) External components (e.g. safety relays) are necessary for using the STO safety function.		
<b>Digital outputs</b>	2 relay changeover contacts 250 V AC, 2 A (inductive load), 30 V DC, 5 A (ohmic load)		
<b>Analog inputs</b>	2 analog inputs Differential input Switchable between voltage (-10 ... +10 V) and current (0/4 ... 20 mA) using a DIP switch 12-bit resolution Can be used as additional digital input		
<ul style="list-style-type: none"> <li>Switching threshold: 0 → 1</li> <li>Switching threshold: 1 → 0</li> </ul>	4 V 1.6 V		
<b>Analog outputs</b>	1 non-isolated output Switchable between voltage (0 ... 10 V) and current (0/4 ... 20 mA) using a parameter Voltage mode: 10 V, min. burden 10 kΩ Current mode: 20 mA, max. burden 500 Ω The analog outputs have short-circuit protection		
<b>PTC/KTY/Pt1000 interface</b>	1 motor temperature sensor input Connectable sensors PTC, Pt1000, KTY and bimetal, accuracy ±5 °C <b>Note:</b> Connection and evaluation of a recommended, optional Pt100 temperature sensor possible by using a free analog input and output		
<b>Voltage supply for the integrated Control Unit</b>	24 V DC via the Power Module or by connecting to an external 20.4 ... 28.8 V DC power supply Typical input current: 500 mA at 24 V DC		
Tool interfaces			
<b>Memory card</b>	Optional SINAMICS SD card		
<b>Operator panels</b>	Optional BOP-2 Basic Operator Panel or IOP-2 Intelligent Operator Panel or SINAMICS G120 Smart Access		

## SINAMICS G120X infrastructure converters for HVAC/Water/Wastewater

0.75 kW to 630 kW (1 hp to 700 hp)

### SINAMICS G120X infrastructure converters for HVAC/Water/Wastewater

#### Technical specifications

SINAMICS G120X converters	
Open-loop/closed-loop control techniques	
V/f linear/quadratic/parameterizable	✓
V/f with flux current control (FCC)	✓
V/f ECO linear/quadratic	✓
Vector control, sensorless	✓
Software functions	
Setpoint input, can be parameterized	✓
Fixed frequencies	16, parameterizable
JOG	✓
Digital motorized potentiometer (MOP)	✓
Ramp smoothing	✓
Extended ramp-function generator (with ramp smoothing OFF3)	✓
Slip compensation	✓
Switchable drive data sets (DDS)	✓ (4)
Switchable command data sets (CDS)	✓ (2)
Free function blocks (FFB) for logical and arithmetic operations	✓ (for frame sizes FSA to FSG)
Flying restart	✓
Automatic restart after line supply failure or operating fault (AR)	✓
Technology controller (internal PID)	✓
Energy saving display	✓
3 additional, free PID controllers	✓
Hibernation mode with internal/external PID controller	✓
Belt monitoring with and without sensor (load torque monitoring)	✓
Dry-running/overload protection monitoring (load torque monitoring)	✓
Deragging	✓
Thermal motor protection	✓ ( $R_t$ , sensor: PTC, Pt100, Pt1000, KTY and bimetal)
Thermal converter protection	✓
Motor identification	✓
Auto-ramping ( $V_{dc\_max}$ controller)	✓
Kinetic buffering ( $V_{dc\_min}$ controller)	✓
Braking functions	
• DC braking	✓
• Compound braking	✓

2

# SINAMICS G120X infrastructure converters for HVAC/Water/Wastewater

0.75 kW to 630 kW (1 hp to 700 hp)

## SINAMICS G120X infrastructure converters for HVAC/Water/Wastewater

### Technical specifications

#### General technical specifications of the power electronics

##### System operating voltage

- Frame sizes FSA to FSG  
For systems complying with IEC:  
200 ... 240 V 3 AC +10 % -20 %  
380 ... 480 V 3 AC +10 % -20 %  
500 ... 690 V 3 AC +10 % -20 %  
For systems complying with UL:  
200 ... 240 V 3 AC  
380 ... 480 V 3 AC  
500 ... 600 V 3 AC
- Frame sizes FSH and FSJ  
380 ... 480 V 3 AC +10 % -15 %  
500 ... 690 V 3 AC +10 % -15 %

##### Line supply requirements Line impedance $u_K$

- Frame sizes FSA to FSG  
4 %
- Frame sizes FSH and FSJ  
A line reactor ( $u_K = 2 %$ ) must be connected in series, if the short-circuit power ratio  $R_{SC} > 33$  (315 ... 500 kW) or  $R_{SC} > 20$  (560 kW)

##### Input frequency

47 ... 63 Hz

##### Output frequency

- Frame sizes FSA to FSG  
Control mode V/f: 0 ... 550 Hz  
Control mode Vector: 0 ... 240 Hz
- Frame sizes FSH and FSJ  
Control mode V/f: 0 ... 150 Hz  
Control mode Vector: 0 ... 150 Hz

##### Pulse frequency

- Frame sizes FSA to FSG  
200 V:  
4 kHz  
Higher pulse frequencies up to 16 kHz [see derating data](#)  
400 V:  
4 kHz for converters with a rated power  $\leq 90$  kW  
2 kHz for converters with a rated power  $\geq 110$  kW  
Higher pulse frequencies up to 16 kHz [see derating data](#)  
690 V:  
2 kHz  
Higher pulse frequencies up to 4 kHz [see derating data](#)
- Frame sizes FSH and FSJ  
2 kHz  
Self-adjusting up to 4 kHz [see derating data](#)

##### Power factor $\lambda$

- Frame sizes FSA to FSG  
0.75 ... 0.93
- Frame sizes FSH and FSJ  
0.75 ... 0.93 (with line reactor  $u_K = 2 %$ )

##### Offset factor $\cos \varphi$

- Frame sizes FSA to FSG  
0.96
- Frame sizes FSD to FSG  
0.99
- Frame sizes FSH and FSJ  
0.96

##### Output voltage, max. as % of line voltage

97 %

##### Overload capability

- Low overload (LO)  
1.1 × base-load current  $I_L$  (i. e. 110 % overload) for 60 s within a cycle time of 300 s
- High overload (HO)  
1.5 × base-load current  $I_H$  (i. e. 150 % overload) for 60 s within a cycle time of 600 s

##### Cooling

Air cooling using an integrated fan

##### Installation altitude

Up to 1000 m (3281 ft) above sea level without derating,  
> 1000 m (3281 ft) [see derating characteristics](#)

##### Short Circuit Current Rating (SCCR) max.

100 kA [see Recommended line-side overcurrent protection devices](#) – the value depends on the fuses and circuit breakers used

For more information, see:  
<https://support.industry.siemens.com/cs/document/109762895>

##### Protection functions

- Undervoltage
- Overvoltage
- Overcurrent/overload
- Ground fault
- Short-circuit
- Stall protection
- Motor blocking protection
- Motor overtemperature
- Converter overtemperature
- Parameter locking

# SINAMICS G120X infrastructure converters for HVAC/Water/Wastewater

0.75 kW to 630 kW (1 hp to 700 hp)

## SINAMICS G120X infrastructure converters for HVAC/Water/Wastewater

### Technical specifications

#### Maximum permissible motor cable lengths SINAMICS G120X

The values specified in the table below apply with low-capacitance CY cables and with pulse frequencies set in the factory.

	Maximum permissible motor cable lengths (shielded/unshielded) in m (ft)			
	FSA to FSC	FSD and FSE	FSF and FSG	FSH and FSJ
<b>Without compliance to the EMC category</b>				
<b>Converters without optional power components</b>				
• 200 V versions	150/300 (492/984)	200/300 (656/984)	FSF: 300/450 (984/1476)	–
• 400 V versions	150/300 (492/984)	200/300 (656/984)	300/450 (984/1476)	150/200 (492/656)
• 690 V versions	–	FSD ≤ 30 kW: 200/300 (656/984) FSD 37 kW, FSE: 300/450 (984/1476)	300/450 (984/1476)	150/200 (492/656)
<b>Converters with one optional output reactor</b>				
• 200 V versions	–	–	–	–
• 400 V versions	–	200/300 (656/984) <sup>1)</sup>	300/450 (984/1476) <sup>1)</sup>	300/450 (984/1476)
• 690 V versions	–	FSD ≤ 30 kW: 200/300 (656/984) <sup>1)</sup> FSD 37 kW, FSE: 300/450 (984/1476) <sup>1)</sup>	300/450 (984/1476) <sup>1)</sup>	300/450 (984/1476)
<b>Converters with two in series connected optional output reactors <sup>1)</sup></b>				
• 200 V versions	–	–	–	–
• 400 V versions	–	350/525 (1148/1723)	525/800 (1723/2625)	–
• 690 V versions	–	FSD ≤ 30 kW: 350/525 (1148/1723) FSD 37 kW, FSE: 525/800 (1723/2625)	525/800 (1723/2625)	–
<b>Converters with optional sine-wave filter</b>				
• 200 V versions	–	–	–	–
• 400 V versions	200/300 (656/984)	200/300 (656/984)	FSF: 200/300 (656/984) FSG: 300/450 (984/1476)	–
• 690 V versions	–	–	–	–
<b>Converters with optional dv/dt filter plus VPL</b>				
• 200 V versions	–	–	–	–
• 400 V versions	–	350/525 (1148/1723)	650/800 (2133/2625)	300/450 (984/1476)
• 690 V versions	–	FSD ≤ 30 kW: 350/525 (1148/1723) FSD 37 kW, FSE: 450/625 (1476/2051) <sup>2)</sup>	450/625 (1476/2051) <sup>2)</sup>	300/450 (984/1476)
<b>With compliance to the EMC category <sup>3)</sup></b>				
<b>Converters with integrated line filter</b>				
for observance of the limit values for conducted RF emissions according to IEC 61800-3 <u>Category C3</u>				
• 200 V versions	–	–	–	–
• 400 V versions	150/– (492/–)	200/– (656/–)	200/– (656/–)	150/– (492/–) <sup>4)</sup>
• 690 V versions	–	150/– (492/–)	150/– (492/–)	150/– (492/–) <sup>4)</sup>
<b>Converters with integrated line filter with external line filter Category C2</b>				
for observance of the limit values for conducted RF emissions according to IEC 61800-3 <u>Category C2</u> / EN 55011:2016 Class A				
• 200 V versions	–	–	–	–
• 400 V versions	–	–	–	150/– (492/–)
• 690 V versions	–	–	–	150/– (492/–)
<b>Converters with integrated line filter</b>				
for observance of the limit values for conducted RF emissions according to IEC 61800-3 <u>Category C2</u> / EN 55011:2016 Class A				
• 200 V versions	–	–	–	–
• 400 V versions	150/– (492/–)	150/– (492/–)	150/– (492/–)	–
• 690 V versions	–	100/– (328/–)	–	–
<b>Converters with integrated line filter with external sine-wave filter</b>				
for observance of the limit values for conducted RF emissions according to IEC 61800-3 <u>Category C2</u> / EN 55011:2016 Class A or according to IEC 61800-3 <u>Category C3</u>				
• 200 V versions	–	–	–	–
• 400 V versions	Category C2 FSA: 100/– (328/–) FSB: 200/– (656/–) Category C3 FSC: 200/– (656/–)	Category C2 150/– (492/–)	Category C2 150/– (492/–)	–
• 690 V versions	–	–	–	–
<b>Converters without/with integrated line filter with external line filter Category C1</b>				
for observance of the limit values for conducted RF emissions according to IEC 61800-3 <u>Category C1</u> / EN 55011:2016 Class B				
• 200 V versions	–	–	–	–
• 400 V versions	Without integrated line filter 50/– (164/–) <sup>3)</sup>	Without integrated line filter 50/– (164/–) <sup>3)</sup>	Without integrated line filter FSF ≤ 90 kW: 50/– (164/–) <sup>3)</sup> With integrated line filter FSF 110 kW: 10/– (23.8/–) <sup>3)</sup>	–
• 690 V versions	–	–	–	–

<sup>1)</sup> For frame sizes FSD to FSG the maximum permissible cable lengths are not increased with one output reactor. By means of the output reactor, the loading of the motor windings is reduced by lower rates of voltage rise ( $dv/dt$ ). By means of two output reactors connected in series, the maximum permissible cable lengths for frame sizes FSD to FSG are increased.

<sup>2)</sup> Maximum overvoltage at the motor terminals <1350 V.

<sup>3)</sup> Further information especially to achieve EMC Category C1 is available in the manual on the internet at:  
[www.siemens.com/sinamics-g120x/documentation](http://www.siemens.com/sinamics-g120x/documentation)

<sup>4)</sup> For motor cable lengths of 100 m (328 ft) up to 150 m (492 ft) with an additional basic interference suppression module (available on request).

# SINAMICS G120X infrastructure converters for HVAC/Water/Wastewater

0.75 kW to 630 kW (1 hp to 700 hp)

## SINAMICS G120X infrastructure converters for HVAC/Water/Wastewater

### Technical specifications

#### SINAMICS G120X converters · Degree of protection IP20/UL Open Type · 200 ... 240 V 3 AC

		6SL32.0-.YC10-.U.0	6SL32.0-.YC12-.U.0	6SL32.0-.YC14-.U.0	6SL32.0-.YC16-.U.0
Type of voltage		3 AC	3 AC	3 AC	3 AC
Line voltage	V	200 ... 240	200 ... 240	200 ... 240	200 ... 240
Output current at line voltage 200 V					
• without overload rated value	A	4.4	6.1	7.7	10.8
• with low overload rated value	A	4.2	6.0	7.4	10.4
• with high overload rated value	A	3.2	4.2	6.0	7.4
• maximum	A	5.7	8.1	10.0	14.1
Supplied active power at rated value of output voltage and at line voltage 200 V					
• with low overload	kW	0.75	1.1	1.5	2.2
• with high overload	kW	0.55	0.75	1.1	1.5
Supplied active power [hp] at rated value of output voltage and at line voltage 240 V					
• with low overload	hp	1	1.5	2	3
• with high overload	hp	0.75	1	1.5	2
Pulse frequency	kHz	4	4	4	4
Efficiency		0.96	0.96	0.96	0.96
Power loss maximum <sup>1)</sup>	kW	0.04	0.05	0.07	0.12
Cooling air flow	m <sup>3</sup> /s (ft <sup>3</sup> /h)	0.005 (0.177)	0.0092 (0.325)	0.0092 (0.325)	0.0092 (0.325)
1 m measuring surface sound pressure level maximum	dB	55	55	55	63
Input current at line voltage 200 V					
• with low overload rated value	A	3.8	5.4	6.7	9.6
• with high overload rated value	A	2.8	3.8	5.4	6.7
for mains supply line					
• Type of electrical connection		Screw-type terminals	Screw-type terminals	Screw-type terminals	Screw-type terminals
• Number of connections		1	1	1	1
• Connectable conductor cross-section	mm <sup>2</sup>	1.5 ... 2.5	1.5 ... 2.5	1.5 ... 2.5	1.5 ... 6
• as coded connectable conductor cross section		AWG 16 ... AWG 14	AWG 16 ... AWG 14	AWG 16 ... AWG 14	AWG 16 ... AWG 10
for motor supply line					
• Type of electrical connection		Screw-type terminals	Screw-type terminals	Screw-type terminals	Screw-type terminals
• Number of connections		1	1	1	1
• Connectable conductor cross-section	mm <sup>2</sup>	1.5 ... 2.5	1.5 ... 2.5	1.5 ... 2.5	1.5 ... 6
• as coded connectable conductor cross section		AWG 16 ... AWG 14	AWG 16 ... AWG 14	AWG 16 ... AWG 14	AWG 16 ... AWG 10
Type of electrical connection for PE conductor		On housing with M4 screw	On housing with M4 screw	On housing with M4 screw	On housing with M4 screw
Cable length for motor					
• shielded maximum <sup>2)</sup>	m (ft)	150 (492.12598)	150 (492.12598)	150 (492.12598)	150 (492.12598)
• unshielded maximum <sup>2)</sup>	m (ft)	300 (984.25197)	300 (984.25197)	300 (984.25197)	300 (984.25197)
Dimensions					
• Width	mm (in)	73 (2.87402)	73 (2.87402)	73 (2.87402)	100 (3.93701)
• Height	mm (in)	232 (9.13386)	232 (9.13386)	232 (9.13386)	275 (10.82677)
• Depth	mm (in)	209 (8.22835)	209 (8.22835)	209 (8.22835)	209 (8.22835)
• Depth, with operator panel	mm (in)	218 (8.58268)	218 (8.58268)	218 (8.58268)	218 (8.58268)
Frame size		FSA	FSA	FSA	FSB
Weight, approx.	kg (lb)	3.3 (7.275246)	3.3 (7.275246)	3.3 (7.275246)	5.8 (12.786796)

<sup>1)</sup> Typical values. More information can be found on the internet at <https://support.industry.siemens.com/cs/document/94059311>

<sup>2)</sup> The values apply without compliance to the EMC category. For more information, see Maximum permissible motor cable lengths SINAMICS G120X and on the internet at [www.siemens.com/sinamics-g120x/documentation](http://www.siemens.com/sinamics-g120x/documentation)

## SINAMICS G120X infrastructure converters for HVAC/Water/Wastewater

0.75 kW to 630 kW (1 hp to 700 hp)

### SINAMICS G120X infrastructure converters for HVAC/Water/Wastewater

#### Technical specifications

		6SL32.0-.YC18-.U.0	6SL32.0-.YC20-.U.0	6SL32.0-.YC22-.U.0	6SL32.0-.YC24-.U.0
Type of voltage		3 AC	3 AC	3 AC	3 AC
Line voltage	V	200 ... 240	200 ... 240	200 ... 240	200 ... 240
Output current at line voltage 200 V					
• without overload rated value	A	14.1	18.1	22.8	29.0
• with low overload rated value	A	13.6	17.5	22.0	28.0
• with high overload rated value	A	10.4	13.6	17.5	22.0
• maximum	A	18.4	23.7	29.7	37.8
Supplied active power at rated value of output voltage and at line voltage 200 V					
• with low overload	kW	3	4	5.5	7.5
• with high overload	kW	2.2	3	4	5.5
Supplied active power [hp] at rated value of output voltage and at line voltage 240 V					
• with low overload	hp	4	5	7.5	10
• with high overload	hp	3	4	5	7.5
Pulse frequency	kHz	4	4	4	4
Efficiency		0.96	0.96	0.97	0.97
Power loss maximum <sup>1)</sup>	kW	0.14	0.18	0.2	0.26
Cooling air flow	m <sup>3</sup> /s (ft <sup>3</sup> /h)	0.0185 (0.653)	0.0185 (0.653)	0.0185 (0.653)	0.0185 (0.653)
1 m measuring surface sound pressure level maximum	dB	63	63	67	67
Input current at line voltage 200 V					
• with low overload rated value	A	12.7	16.3	20.8	26.3
• with high overload rated value	A	9.6	12.7	16.3	20.8
for mains supply line					
• Type of electrical connection		Screw-type terminals	Screw-type terminals	Screw-type terminals	Screw-type terminals
• Number of connections		1	1	1	1
• Connectable conductor cross-section	mm <sup>2</sup>	1.5 ... 6	1.5 ... 6	1.5 ... 16	1.5 ... 16
• as coded connectable conductor cross section		AWG 16 ... AWG 10	AWG 16 ... AWG 10	AWG 16 ... AWG 6	AWG 16 ... AWG 6
for motor supply line					
• Type of electrical connection		Screw-type terminals	Screw-type terminals	Screw-type terminals	Screw-type terminals
• Number of connections		1	1	1	1
• Connectable conductor cross-section	mm <sup>2</sup>	1.5 ... 6	1.5 ... 6	1.5 ... 16	1.5 ... 16
• as coded connectable conductor cross section		AWG 16 ... AWG 10	AWG 16 ... AWG 10	AWG 16 ... AWG 6	AWG 16 ... AWG 6
Type of electrical connection for PE conductor		On housing with M4 screw	On housing with M4 screw	On housing with M4 screw	On housing with M4 screw
Cable length for motor					
• shielded maximum <sup>2)</sup>	m (ft)	150 (492.12598)	150 (492.12598)	150 (492.12598)	150 (492.12598)
• unshielded maximum <sup>2)</sup>	m (ft)	300 (984.25197)	300 (984.25197)	300 (984.25197)	300 (984.25197)
Dimensions					
• Width	mm (in)	100 (3.93701)	100 (3.93701)	140 (5.51181)	140 (5.51181)
• Height	mm (in)	275 (10.82677)	275 (10.82677)	295 (11.61417)	295 (11.61417)
• Depth	mm (in)	209 (8.22835)	209 (8.22835)	209 (8.22835)	209 (8.22835)
• Depth, with operator panel	mm (in)	218 (8.58268)	218 (8.58268)	218 (8.58268)	218 (8.58268)
Frame size		FSB	FSB	FSC	FSC
Weight, approx.	kg (lb)	5.8 (12.786796)	5.8 (12.786796)	7.1 (15.652802)	7.1 (15.652802)

<sup>1)</sup> Typical values. More information can be found on the internet at <https://support.industry.siemens.com/cs/document/94059311>

<sup>2)</sup> The values apply without compliance to the EMC category. For more information, see Maximum permissible motor cable lengths SINAMICS G120X and on the internet at [www.siemens.com/sinamics-g120x/documentation](http://www.siemens.com/sinamics-g120x/documentation)

# SINAMICS G120X infrastructure converters for HVAC/Water/Wastewater

0.75 kW to 630 kW (1 hp to 700 hp)

## SINAMICS G120X infrastructure converters for HVAC/Water/Wastewater

### Technical specifications

		6SL32.0-.YC26-.U.0	6SL32.0-.YC28-.U.0	6SL32.0-.YC30-.U.0	6SL32.0-.YC32-.U.0
Type of voltage		3 AC	3 AC	3 AC	3 AC
Line voltage	V	200 ... 240	200 ... 240	200 ... 240	200 ... 240
Output current at line voltage 200 V					
• without overload rated value	A	43	56	70	82
• with low overload rated value	A	42	54	68	80
• with high overload rated value	A	28	42	54	68
• maximum	A	57	73	92	108
Supplied active power at rated value of output voltage and at line voltage 200 V					
• with low overload	kW	11	15	18.5	22
• with high overload	kW	7.5	11	15	18.5
Supplied active power [hp] at rated value of output voltage and at line voltage 240 V					
• with low overload	hp	15	20	25	30
• with high overload	hp	10	15	20	25
Pulse frequency	kHz	4	4	4	4
Efficiency		0.97	0.97	0.97	0.97
Power loss maximum <sup>1)</sup>	kW	0.45	0.61	0.82	0.92
Cooling air flow	m <sup>3</sup> /s (ft <sup>3</sup> /h)	0.055 (1.942)	0.055 (1.942)	0.055 (1.942)	0.083 (2.931)
1 m measuring surface sound pressure level maximum	dB	70	70	70	70
Input current at line voltage 200 V					
• with low overload rated value	A	40	51	64	76
• with high overload rated value	A	26.3	40	51	64
for mains supply line					
• Type of electrical connection		Screw-type terminals	Screw-type terminals	Screw-type terminals	Screw-type terminals
• Number of connections		1	1	1	1
• Connectable conductor cross-section	mm <sup>2</sup>	10 ... 35	10 ... 35	10 ... 35	25 ... 70
• as coded connectable conductor cross section		AWG 8 ... AWG 2	AWG 8 ... AWG 2	AWG 8 ... AWG 2	AWG 6 ... AWG 3/0
for motor supply line					
• Type of electrical connection		Screw-type terminals	Screw-type terminals	Screw-type terminals	Screw-type terminals
• Number of connections		1	1	1	1
• Connectable conductor cross-section	mm <sup>2</sup>	10 ... 35	10 ... 35	10 ... 35	25 ... 70
• as coded connectable conductor cross section		AWG 8 ... AWG 2	AWG 8 ... AWG 2	AWG 8 ... AWG 2	AWG 6 ... AWG 3/0
Type of electrical connection for PE conductor		Screw-type terminals	Screw-type terminals	Screw-type terminals	Screw-type terminals
Cable length for motor					
• shielded maximum <sup>2)</sup>	m (ft)	200 (656.16798)	200 (656.16798)	200 (656.16798)	200 (656.16798)
• unshielded maximum <sup>2)</sup>	m (ft)	300 (984.25197)	300 (984.25197)	300 (984.25197)	300 (984.25197)
Dimensions					
• Width	mm (in)	200 (7.87402)	200 (7.87402)	200 (7.87402)	275 (10.82677)
• Height	mm (in)	472 (18.58268)	472 (18.58268)	472 (18.58268)	551 (21.69291)
• Depth	mm (in)	239 (9.40945)	239 (9.40945)	239 (9.40945)	239 (9.40945)
• Depth, with operator panel	mm (in)	248 (9.76378)	248 (9.76378)	248 (9.76378)	248 (9.76378)
Frame size		FSD	FSD	FSD	FSE
Weight, approx.	kg (lb)	16.6 (36.596692)	16.6 (36.596692)	16.6 (36.596692)	16.6 (36.596692)

<sup>1)</sup> Typical values. More information can be found on the internet at <https://support.industry.siemens.com/cs/document/94059311>

<sup>2)</sup> The values apply without compliance to the EMC category. For more information, see Maximum permissible motor cable lengths SINAMICS G120X and on the internet at [www.siemens.com/sinamics-g120x/documentation](http://www.siemens.com/sinamics-g120x/documentation)

## SINAMICS G120X infrastructure converters for HVAC/Water/Wastewater

0.75 kW to 630 kW (1 hp to 700 hp)

### SINAMICS G120X infrastructure converters for HVAC/Water/Wastewater

#### Technical specifications

		6SL32.0-.YC34-.U.0	6SL32.0-.YC36-.U.0	6SL32.0-.YC38-.U.0	6SL32.0-.YC40-.U.0
Type of voltage		3 AC	3 AC	3 AC	3 AC
Line voltage	V	200 ... 240	200 ... 240	200 ... 240	200 ... 240
Output current at line voltage 200 V					
• without overload rated value	A	107	133	158	197
• with low overload rated value	A	104	130	154	192
• with high overload rated value	A	80	104	130	154
• maximum	A	141	176	208	260
Supplied active power at rated value of output voltage and at line voltage 200 V					
• with low overload	kW	30	37	45	55
• with high overload	kW	22	30	37	45
Supplied active power [hp] at rated value of output voltage and at line voltage 240 V					
• with low overload	hp	40	50	60	75
• with high overload	hp	30	40	50	60
Pulse frequency	kHz	4	4	4	4
Efficiency		0.97	0.97	0.97	0.97
Power loss maximum <sup>1)</sup>	kW	1.28	1.38	1.72	2.09
Cooling air flow	m <sup>3</sup> /s (ft <sup>3</sup> /h)	0.083 (2.931)	0.153 (5.403)	0.153 (5.403)	0.153 (5.403)
1 m measuring surface sound pressure level maximum	dB	70	72	72	72
Input current at line voltage 200 V					
• with low overload rated value	A	98	126	149	172
• with high overload rated value	A	76	98	126	149
for mains supply line					
• Type of electrical connection		Screw-type terminals	M10 screw	M10 screw	M10 screw
• Number of connections		1	2	2	2
• Connectable conductor cross-section	mm <sup>2</sup>	25 ... 70	35 ... 120	35 ... 120	35 ... 120
• as coded connectable conductor cross section		AWG 6 ... AWG 3/0	AWG 1 ... AWG 2 ×4/0	AWG 1 ... AWG 2 ×4/0	AWG 1 ... AWG 2 ×4/0
for motor supply line					
• Type of electrical connection		Screw-type terminals	M10 screw	M10 screw	M10 screw
• Number of connections		1	2	2	2
• Connectable conductor cross-section	mm <sup>2</sup>	25 ... 70	35 ... 120	35 ... 120	35 ... 120
• as coded connectable conductor cross section		AWG 6 ... AWG 3/0	AWG 1 ... AWG 2 ×4/0	AWG 1 ... AWG 2 ×4/0	AWG 1 ... AWG 2 ×4/0
Type of electrical connection for PE conductor		Screw-type terminals	M10 screw	M10 screw	M10 screw
Cable length for motor					
• shielded maximum <sup>2)</sup>	m (ft)	200 (656.16798)	300 (984.25197)	300 (984.25197)	300 (984.25197)
• unshielded maximum <sup>2)</sup>	m (ft)	300 (984.25197)	450 (1476.37795)	450 (1476.37795)	450 (1476.37795)
Dimensions					
• Width	mm (in)	275 (10.82677)	305 (12.00787)	305 (12.00787)	305 (12.00787)
• Height	mm (in)	551 (21.69291)	709 (27.91339)	709 (27.91339)	709 (27.91339)
• Depth	mm (in)	239 (9.40945)	360 (14.17323)	360 (14.17323)	360 (14.17323)
• Depth, with operator panel	mm (in)	248 (9.76378)	369 (14.52756)	369 (14.52756)	369 (14.52756)
Frame size		FSE	FSF	FSF	FSF
Weight, approx.	kg (lb)	16.6 (36.596692)	18.8 (41.446856)	17.6 (38.801312)	26.7 (58.863354)

<sup>1)</sup> Typical values. More information can be found on the internet at <https://support.industry.siemens.com/cs/document/94059311>

<sup>2)</sup> The values apply without compliance to the EMC category. For more information, see Maximum permissible motor cable lengths SINAMICS G120X and on the internet at [www.siemens.com/sinamics-g120x/documentation](http://www.siemens.com/sinamics-g120x/documentation)



# SINAMICS G120X infrastructure converters for HVAC/Water/Wastewater

0.75 kW to 630 kW (1 hp to 700 hp)

## SINAMICS G120X infrastructure converters for HVAC/Water/Wastewater

### Technical specifications

#### SINAMICS G120X converters · Degree of protection IP20/UL Open Type · 380 ... 480 V 3 AC

		6SL32.0-.YE10-.A.0 6SL32.0-.YE10-.U.0	6SL32.0-.YE12-.A.0 6SL32.0-.YE12-.U.0	6SL32.0-.YE14-.A.0 6SL32.0-.YE14-.U.0	6SL32.0-.YE16-.A.0 6SL32.0-.YE16-.U.0
Type of voltage		3 AC	3 AC	3 AC	3 AC
Line voltage	V	380 ... 480	380 ... 480	380 ... 480	380 ... 480
Output current at line voltage 400 V					
• without overload rated value	A	2.3	3.2	4.3	6.1
• with low overload rated value	A	2.2	3.1	4.1	5.9
• with high overload rated value	A	1.7	2.2	3.1	4.1
• maximum	A	2.7	3.4	4.8	6.4
Supplied active power at rated value of output voltage and at line voltage 400 V					
• with low overload	kW	0.75	1.1	1.5	2.2
• with high overload	kW	0.55	0.75	1.1	1.5
Supplied active power [hp] at rated value of output voltage and at line voltage 480 V					
• with low overload	hp	1	1.5	2	3
• with high overload	hp	0.75	1	1.5	2
Pulse frequency	kHz	4	4	4	4
Efficiency		0.98	0.98	0.98	0.98
Power loss maximum <sup>1)</sup>	kW	0.04	0.05	0.06	0.08
Cooling air flow	m <sup>3</sup> /s (ft <sup>3</sup> /h)	0.005 (635.66406)	0.005 (635.66406)	0.005 (635.66406)	0.005 (635.66406)
1 m measuring surface sound pressure level maximum	dB	55	55	55	55
Input current at line voltage 400 V					
• with low overload rated value	A	2.1	2.8	3.6	5.5
• with high overload rated value	A	1.62	1.99	2.72	3.82
for mains supply line					
• Type of electrical connection		Screw-type terminals	Screw-type terminals	Screw-type terminals	Screw-type terminals
• Number of connections		1	1	1	1
• Connectable conductor cross-section	mm <sup>2</sup>	1.5 ... 2.5	1.5 ... 2.5	1.5 ... 2.5	1.5 ... 2.5
• as coded connectable conductor cross section		AWG 16 ... AWG 14	AWG 16 ... AWG 14	AWG 16 ... AWG 14	AWG 16 ... AWG 14
for motor supply line					
• Type of electrical connection		Screw-type terminals	Screw-type terminals	Screw-type terminals	Screw-type terminals
• Number of connections		1	1	1	1
• Connectable conductor cross-section	mm <sup>2</sup>	1.5 ... 2.5	1.5 ... 2.5	1.5 ... 2.5	1.5 ... 2.5
• as coded connectable conductor cross section		AWG 16 ... AWG 14	AWG 16 ... AWG 14	AWG 16 ... AWG 14	AWG 16 ... AWG 14
Type of electrical connection for PE conductor		On housing with M4 screw	On housing with M4 screw	On housing with M4 screw	On housing with M4 screw
Cable length for motor					
• shielded maximum <sup>2)</sup>	m (ft)	150 (492.12598)	150 (492.12598)	150 (492.12598)	150 (492.12598)
• unshielded maximum <sup>2)</sup>	m (ft)	300 (984.25197)	300 (984.25197)	300 (984.25197)	300 (984.25197)
Dimensions					
• Width	mm (in)	73 (2.87402)	73 (2.87402)	73 (2.87402)	73 (2.87402)
• Height	mm (in)	232 (9.13386)	232 (9.13386)	232 (9.13386)	232 (9.13386)
• Depth	mm (in)	209 (8.22835)	209 (8.22835)	209 (8.22835)	209 (8.22835)
• Depth, with operator panel	mm (in)	218 (8.58268)	218 (8.58268)	218 (8.58268)	218 (8.58268)
Frame size		FSA	FSA	FSA	FSA
Weight, approx. <sup>3)</sup>	kg (lb)	3.2 (7.05478)	3.2 (7.05478)	3.2 (7.05478)	3.2 (7.05478)

<sup>1)</sup> Typical values. More information can be found on the internet at <https://support.industry.siemens.com/cs/document/94059311>

<sup>2)</sup> The values apply without compliance to the EMC category. For more information, see Maximum permissible motor cable lengths SINAMICS G120X and on the internet at [www.siemens.com/sinamics-g120x/documentation](http://www.siemens.com/sinamics-g120x/documentation)

<sup>3)</sup> The values apply for converters without integrated line filter. For more information, see on the internet at [www.siemens.com/sinamics-g120x/documentation](http://www.siemens.com/sinamics-g120x/documentation)

## SINAMICS G120X infrastructure converters for HVAC/Water/Wastewater

0.75 kW to 630 kW (1 hp to 700 hp)

### SINAMICS G120X infrastructure converters for HVAC/Water/Wastewater

#### Technical specifications

		6SL32.0-.YE18-.A.0 6SL32.0-.YE18-.U.0	6SL32.0-.YE20-.A.0 6SL32.0-.YE20-.U.0	6SL32.0-.YE22-.A.0 6SL32.0-.YE22-.U.0	6SL32.0-.YE24-.A.0 6SL32.0-.YE24-.U.0
Type of voltage		3 AC	3 AC	3 AC	3 AC
Line voltage	V	380 ... 480	380 ... 480	380 ... 480	380 ... 480
Output current at line voltage 400 V					
• without overload rated value	A	8	10.5	13.6	18.5
• with low overload rated value	A	7.7	10.2	13.2	18
• with high overload rated value	A	5.9	7.7	10.2	13.2
• maximum	A	9.1	14	18	24
Supplied active power at rated value of output voltage and at line voltage 400 V					
• with low overload	kW	3	4	5.5	7.5
• with high overload	kW	2.2	3	4	5.5
Supplied active power [hp] at rated value of output voltage and at line voltage 480 V					
• with low overload	hp	4	5	7.5	10
• with high overload	hp	3	4	5	7.5
Pulse frequency	kHz	4	4	4	4
Efficiency		0.98	0.98	0.98	0.98
Power loss maximum <sup>1)</sup>	kW	0.126	0.138	0.181	0.245
Cooling air flow	m <sup>3</sup> /s (ft <sup>3</sup> /h)	0.005 (635.66406)	0.005 (635.66406)	0.0092 (1169.62187)	0.0092 (1169.62187)
1 m measuring surface sound pressure level maximum	dB	55	63	63	63
Input current at line voltage 400 V					
• with low overload rated value	A	6.9	9.75	12	17
• with high overload rated value	A	5.29	7.36	9.27	12.47
for mains supply line					
• Type of electrical connection		Screw-type terminals	Screw-type terminals	Screw-type terminals	Screw-type terminals
• Number of connections		1	1	1	1
• Connectable conductor cross-section	mm <sup>2</sup>	1.5 ... 2.5	1.5 ... 6	1.5 ... 6	1.5 ... 6
• as coded connectable conductor cross section		18 ... 14	10 ... 6	10 ... 6	10 ... 6
for motor supply line					
• Type of electrical connection		Screw-type terminals	Screw-type terminals	Screw-type terminals	Screw-type terminals
• Number of connections		1	1	1	1
• Connectable conductor cross-section	mm <sup>2</sup>	1.5 ... 2.5	1.5 ... 6	1.5 ... 6	1.5 ... 6
• as coded connectable conductor cross section		18 ... 14	10 ... 6	10 ... 6	10 ... 6
Type of electrical connection for PE conductor		On housing with M4 screw	On housing with M4 screw	On housing with M4 screw	On housing with M4 screw
Cable length for motor					
• shielded maximum <sup>2)</sup>	m (ft)	150 (492.12598)	150 (492.12598)	150 (492.12598)	150 (492.12598)
• unshielded maximum <sup>2)</sup>	m (ft)	300 (984.25197)	300 (984.25197)	300 (984.25197)	300 (984.25197)
Dimensions					
• Width	mm (in)	73 (2.87402)	100 (3.93701)	100 (3.93701)	100 (3.93701)
• Height	mm (in)	232 (9.13386)	275 (10.82677)	275 (10.82677)	275 (10.82677)
• Depth	mm (in)	209 (8.22835)	209 (8.22835)	209 (8.22835)	209 (8.22835)
• Depth, with operator panel	mm (in)	218 (8.58268)	218 (8.58268)	218 (8.58268)	218 (8.58268)
Frame size		FSA	FSB	FSB	FSB
Weight, approx. <sup>3)</sup>	kg (lb)	3.2 (7.05478)	5.83 (12.85293)	5.83 (12.85293)	5.83 (12.85293)

<sup>1)</sup> Typical values. More information can be found on the internet at <https://support.industry.siemens.com/cs/document/94059311>

<sup>2)</sup> The values apply without compliance to the EMC category. For more information, see Maximum permissible motor cable lengths SINAMICS G120X and on the internet at [www.siemens.com/sinamics-g120x/documentation](http://www.siemens.com/sinamics-g120x/documentation)

<sup>3)</sup> The values apply for converters without integrated line filter. For more information, see on the internet at [www.siemens.com/sinamics-g120x/documentation](http://www.siemens.com/sinamics-g120x/documentation)

# SINAMICS G120X infrastructure converters for HVAC/Water/Wastewater

0.75 kW to 630 kW (1 hp to 700 hp)

## SINAMICS G120X infrastructure converters for HVAC/Water/Wastewater

### Technical specifications

		6SL32.0-.YE26-.A.0 6SL32.0-.YE26-.U.0	6SL32.0-.YE28-.A.0 6SL32.0-.YE28-.U.0	6SL32.0-.YE30-.A.0 6SL32.0-.YE30-.U.0	6SL32.0-.YE32-.A.0 6SL32.0-.YE32-.U.0
Type of voltage		3 AC	3 AC	3 AC	3 AC
Line voltage	V	380 ... 480	380 ... 480	380 ... 480	380 ... 480
Output current at line voltage 400 V					
• without overload rated value	A	27	33	39	47
• with low overload rated value	A	26	32	38	45
• with high overload rated value	A	18	26	32	38
• maximum	A	35	43	51.3	61
Supplied active power at rated value of output voltage and at line voltage 400 V					
• with low overload	kW	11	15	18.5	22
• with high overload	kW	7.5	11	15	18.5
Supplied active power [hp] at rated value of output voltage and at line voltage 480 V					
• with low overload	hp	15	20	25	30
• with high overload	hp	10	15	20	25
Pulse frequency	kHz	4	4	4	4
Efficiency		0.98	0.98	0.98	0.98
Power loss maximum <sup>1)</sup>	kW	0.316	0.396	0.5	0.68
Cooling air flow	m <sup>3</sup> /s (ft <sup>3</sup> /h)	0.0185 (2351,95680)	0.0185 (2351,95680)	0.055 (6992.30465)	0.055 (6992.30465)
1 m measuring surface sound pressure level maximum	dB	67	67	70	70
Input current at line voltage 400 V					
• with low overload rated value	A	24.5	29.5	36	42
• with high overload rated value	A	16.96	23.97	33	38
for mains supply line					
• Type of electrical connection		Screw-type terminals	Screw-type terminals	Screw-type terminals	Screw-type terminals
• Number of connections		1	1	1	1
• Connectable conductor cross-section	mm <sup>2</sup>	1.5 ... 16	1.5 ... 16	10 ... 35	10 ... 35
• as coded connectable conductor cross section		AWG 16 ... AWG 6	AWG 16 ... AWG 6	AWG 8 ... AWG 2	AWG 8 ... AWG 2
for motor supply line					
• Type of electrical connection		Screw-type terminals	Screw-type terminals	Screw-type terminals	Screw-type terminals
• Number of connections		1	1	1	1
• Connectable conductor cross-section	mm <sup>2</sup>	1.5 ... 16	1.5 ... 16	10 ... 35	10 ... 35
• as coded connectable conductor cross section		AWG 16 ... AWG 6	AWG 16 ... AWG 6	AWG 8 ... AWG 2	AWG 8 ... AWG 2
Type of electrical connection for PE conductor		On housing with M4 screw	On housing with M4 screw	Screw-type terminals	Screw-type terminals
Cable length for motor					
• shielded maximum <sup>2)</sup>	m (ft)	150 (492.12598)	150 (492.12598)	200 (656.16798)	200 (656.16798)
• unshielded maximum <sup>2)</sup>	m (ft)	300 (984.25197)	300 (984.25197)	300 (984.25197)	300 (984.25197)
Dimensions					
• Width	mm (in)	140 (5.51181)	140 (5.51181)	200 (7.87402)	200 (7.87402)
• Height	mm (in)	295 (11.61417)	295 (11.61417)	472 (18.58268)	472 (18.58268)
• Depth	mm (in)	209 (8.22835)	209 (8.22835)	239 (9.40945)	239 (9.40945)
• Depth, with operator panel	mm (in)	218 (8.58268)	218 (8.58268)	248 (9.76378)	248 (9.76378)
Frame size		FSC	FSC	FSD	FSD
Weight, approx. <sup>3)</sup>	kg (lb)	7.14 (15.74099)	7.14 (15.74099)	17 (37.47854)	17 (37.47854)

<sup>1)</sup> Typical values. More information can be found on the internet at <https://support.industry.siemens.com/cs/document/94059311>

<sup>2)</sup> The values apply without compliance to the EMC category. For more information, see Maximum permissible motor cable lengths SINAMICS G120X and on the internet at [www.siemens.com/sinamics-g120x/documentation](http://www.siemens.com/sinamics-g120x/documentation)

<sup>3)</sup> The values apply for converters without integrated line filter. For more information, see on the internet at [www.siemens.com/sinamics-g120x/documentation](http://www.siemens.com/sinamics-g120x/documentation)

## SINAMICS G120X infrastructure converters for HVAC/Water/Wastewater

0.75 kW to 630 kW (1 hp to 700 hp)

### SINAMICS G120X infrastructure converters for HVAC/Water/Wastewater

#### Technical specifications

		6SL32.0-.YE34-.A.0 6SL32.0-.YE34-.U.0	6SL32.0-.YE36-.A.0 6SL32.0-.YE36-.U.0	6SL32.0-.YE38-.A.0 6SL32.0-.YE38-.U.0	6SL32.0-.YE40-.A.0 6SL32.0-.YE40-.U.0
Type of voltage		3 AC	3 AC	3 AC	3 AC
Line voltage	V	380 ... 480	380 ... 480	380 ... 480	380 ... 480
Output current at line voltage 400 V					
• without overload rated value	A	62	77	93	113
• with low overload rated value	A	60	75	90	110
• with high overload rated value	A	45	60	75	90
• maximum	A	81	102	122	149
Supplied active power at rated value of output voltage and at line voltage 400 V					
• with low overload	kW	30	37	45	55
• with high overload	kW	22	30	37	45
Supplied active power [hp] at rated value of output voltage and at line voltage 480 V					
• with low overload	hp	40	50	60	75
• with high overload	hp	30	40	50	60
Pulse frequency	kHz	4	4	4	4
Efficiency		0.98	0.98	0.98	0.98
Power loss maximum <sup>1)</sup>	kW	0.77	1.02	1.02	1.55
Cooling air flow	m <sup>3</sup> /s (ft <sup>3</sup> /h)	0.055 (6992.30465)	0.055 (6992.30465)	0.083 (10552.02338)	0.083 (10552.02338)
1 m measuring surface sound pressure level maximum	dB	70	70	70	70
Input current at line voltage 400 V					
• with low overload rated value	A	57	70	86	104
• with high overload rated value	A	47	62	78	94
for mains supply line					
• Type of electrical connection		Screw-type terminals	Screw-type terminals	Screw-type terminals	Screw-type terminals
• Number of connections		1	1	1	1
• Connectable conductor cross-section	mm <sup>2</sup>	10 ... 35	10 ... 35	25 ... 70	25 ... 70
• as coded connectable conductor cross section		AWG 8 ... AWG 2	AWG 8 ... AWG 2	AWG 6 ... AWG 3/0	AWG 6 ... AWG 3/0
for motor supply line					
• Type of electrical connection		Screw-type terminals	Screw-type terminals	Screw-type terminals	Screw-type terminals
• Number of connections		1	1	1	1
• Connectable conductor cross-section	mm <sup>2</sup>	10 ... 35	10 ... 35	25 ... 70	25 ... 70
• as coded connectable conductor cross section		AWG 8 ... AWG 2	AWG 8 ... AWG 2	AWG 6 ... AWG 3/0	AWG 6 ... AWG 3/0
Type of electrical connection for PE conductor		Screw-type terminals	Screw-type terminals	Screw-type terminals	Screw-type terminals
Cable length for motor					
• shielded maximum <sup>2)</sup>	m (ft)	200 (656.16798)	200 (656.16798)	200 (656.16798)	200 (656.16798)
• unshielded maximum <sup>2)</sup>	m (ft)	300 (984.25197)	300 (984.25197)	300 (984.25197)	300 (984.25197)
Dimensions					
• Width	mm (in)	200 (7.87402)	200 (7.87402)	275 (10.82677)	275 (10.82677)
• Height	mm (in)	472 (18.58268)	472 (18.58268)	551 (21.69291)	551 (21.69291)
• Depth	mm (in)	239 (9.40945)	239 (9.40945)	239 (9.40945)	239 (9.40945)
• Depth, with operator panel	mm (in)	248 (9.76378)	248 (9.76378)	248 (9.76378)	248 (9.76378)
Frame size		FSD	FSD	FSE	FSE
Weight, approx. <sup>3)</sup>	kg (lb)	17 (37.47854)	19 (41.88778)	27 (59.52474)	27 (59.52474)

<sup>1)</sup> Typical values. More information can be found on the internet at <https://support.industry.siemens.com/cs/document/94059311>

<sup>2)</sup> The values apply without compliance to the EMC category. For more information, see Maximum permissible motor cable lengths SINAMICS G120X and on the internet at [www.siemens.com/sinamics-g120x/documentation](http://www.siemens.com/sinamics-g120x/documentation)

<sup>3)</sup> The values apply for converters without integrated line filter. For more information, see on the internet at [www.siemens.com/sinamics-g120x/documentation](http://www.siemens.com/sinamics-g120x/documentation)

# SINAMICS G120X infrastructure converters for HVAC/Water/Wastewater

0.75 kW to 630 kW (1 hp to 700 hp)

## SINAMICS G120X infrastructure converters for HVAC/Water/Wastewater

### Technical specifications

		6SL32.0-.YE42-.A.0 6SL32.0-.YE42-.U.0	6SL32.0-.YE44-.A.0 6SL32.0-.YE44-.U.0	6SL32.0-.YE46-.A.0 6SL32.0-.YE46-.U.0	6SL32.0-.YE48-.A.0 6SL32.0-.YE48-.U.0
Type of voltage		3 AC	3 AC	3 AC	3 AC
Line voltage	V	380 ... 480	380 ... 480	380 ... 480	380 ... 480
Output current at line voltage 400 V					
• without overload rated value	A	149	183	210	256
• with low overload rated value	A	145	178	205	250
• with high overload rated value	A	110	145	178	205
• maximum	A	196	241	277	338
Supplied active power at rated value of output voltage and at line voltage 400 V					
• with low overload	kW	75	90	110	132
• with high overload	kW	55	75	90	110
Supplied active power [hp] at rated value of output voltage and at line voltage 480 V					
• with low overload	hp	100	125	150	200
• with high overload	hp	75	100	125	150
Pulse frequency	kHz	4	4	2	2
Efficiency		0.98	0.98	0.98	0.98
Power loss maximum <sup>1)</sup>	kW	1.23	1.57	1.83	2.35
Cooling air flow	m <sup>3</sup> /s (ft <sup>3</sup> /h)	0.153 (19451.32021)	0.153 (19451.32021)	0.153 (19451.32021)	0.153 (19451.32021)
1 m measuring surface sound pressure level maximum	dB	72	72	72	72
Input current at line voltage 400 V					
• with low overload rated value	A	140	172	198	242
• with high overload rated value	A	117	154	189	218
for mains supply line					
• Type of electrical connection		M10 screw	M10 screw	M10 screw	M10 screw
• Number of connections		2	2	2	2
• Connectable conductor cross-section	mm <sup>2</sup>	35 ... 120	35 ... 120	35 ... 120	35 ... 120
• as coded connectable conductor cross section		AWG 2 ... AWG 2 × 4/0	AWG 2 ... AWG 2 × 4/0	AWG 2 ... AWG 2 × 4/0	AWG 2 ... AWG 2 × 4/0
for motor supply line					
• Type of electrical connection		M10 screw	M10 screw	M10 screw	M10 screw
• Number of connections		2	2	2	2
• Connectable conductor cross-section	mm <sup>2</sup>	35 ... 120	35 ... 120	35 ... 120	35 ... 120
• as coded connectable conductor cross section		AWG 2 ... AWG 2 × 4/0	AWG 2 ... AWG 2 × 4/0	AWG 2 ... AWG 2 × 4/0	AWG 2 ... AWG 2 × 4/0
Type of electrical connection for PE conductor		M10 screw	M10 screw	M10 screw	M10 screw
Cable length for motor					
• shielded maximum <sup>2)</sup>	m (ft)	300 (984.25197)	300 (984.25197)	300 (984.25197)	300 (984.25197)
• unshielded maximum <sup>2)</sup>	m (ft)	450 (1476.37795)	450 (1476.37795)	450 (1476.37795)	450 (1476.37795)
Dimensions					
• Width	mm (in)	305 (12.00787)	305 (12.00787)	305 (12.00787)	305 (12.00787)
• Height	mm (in)	709 (27.91339)	709 (27.91339)	709 (27.91339)	709 (27.91339)
• Depth	mm (in)	360 (14.17323)	360 (14.17323)	360 (14.17323)	360 (14.17323)
• Depth, with operator panel	mm (in)	369 (14.52756)	369 (14.52756)	369 (14.52756)	369 (14.52756)
Frame size		FSF	FSF	FSF	FSF
Weight, approx. <sup>3)</sup>	kg (lb)	61 (134.48182)	61 (134.48182)	67 (147.70954)	67 (147.70954)

<sup>1)</sup> Typical values. More information can be found on the internet at <https://support.industry.siemens.com/cs/document/94059311>

<sup>2)</sup> The values apply without compliance to the EMC category. For more information, see Maximum permissible motor cable lengths SINAMICS G120X and on the internet at [www.siemens.com/sinamics-g120x/documentation](http://www.siemens.com/sinamics-g120x/documentation)

<sup>3)</sup> The values apply for converters without integrated line filter. For more information, see on the internet at [www.siemens.com/sinamics-g120x/documentation](http://www.siemens.com/sinamics-g120x/documentation)

## SINAMICS G120X infrastructure converters for HVAC/Water/Wastewater

0.75 kW to 630 kW (1 hp to 700 hp)

### SINAMICS G120X infrastructure converters for HVAC/Water/Wastewater

#### Technical specifications

		6SL32.0-.YE50-.A.0 6SL32.0-.YE50-.C.0	6SL32.0-.YE52-.A.0 6SL32.0-.YE52-.C.0	6SL32.0-.YE54-.A.0 6SL32.0-.YE54-.C.0	6SL3220-.YE56-.C.0
Type of voltage		3 AC	3 AC	3 AC	3 AC
Line voltage	V	380 ... 480	380 ... 480	380 ... 480	380 ... 480
Output current at line voltage 400 V					
• without overload rated value	A	309	379	488	585
• with low overload rated value	A	302	370	477	570
• with high overload rated value	A	250	302	370	468
• maximum	A	408	500	644	770
Supplied active power at rated value of output voltage and at line voltage 400 V					
• with low overload	kW	160	200	250	315
• with high overload	kW	132	160	200	250
Supplied active power [hp] at rated value of output voltage and at line voltage 480 V					
• with low overload	hp	250	300	400	400
• with high overload	hp	200	250	300	300
Pulse frequency	kHz	2	2	2	4
Efficiency		0.98	0.98	0.98	0.98
Power loss maximum <sup>1)</sup>	kW	3.67	4.62	6.18	6.791
Cooling air flow	m <sup>3</sup> /s (ft <sup>3</sup> /h)	0.21 (26697.89049)	0.21 (26697.89049)	0.21 (26697.89049)	0.362 (46022.07788)
1 m measuring surface sound pressure level maximum	dB	74	74	74	74
Input current at line voltage 400 V					
• with low overload rated value	A	301	365	471	585
• with high overload rated value	A	275	330	400	477
for mains supply line					
• Type of electrical connection		M10 screw	M10 screw	M10 screw	M12 screw
• Number of connections		2	2	2	4
• Connectable conductor cross-section	mm <sup>2</sup>	35 ... 185	35 ... 185	35 ... 185	240 ... 240
• as coded connectable conductor cross section		AWG 1 ... MCM 2 × 350	AWG 1 ... MCM 2 × 350	AWG 1 ... MCM 2 × 350	MCM 2 × 500 ... MCM 4 × 500
for motor supply line					
• Type of electrical connection		M10 screw	M10 screw	M10 screw	M12 screw
• Number of connections		2	2	2	4
• Connectable conductor cross-section	mm <sup>2</sup>	35 ... 185	35 ... 185	35 ... 185	240 ... 240
• as coded connectable conductor cross section		AWG 1 ... MCM 2 × 350	AWG 1 ... MCM 2 × 350	AWG 1 ... MCM 2 × 350	MCM 2 × 500 ... MCM 4 × 500
Type of electrical connection for PE conductor		M10 screw	M10 screw	M10 screw	M12 screw
Cable length for motor					
• shielded maximum <sup>2)</sup>	m (ft)	200 (656.16798)	200 (656.16798)	200 (656.16798)	150 (492.12598)
Dimensions					
• Width	mm (in)	305 (12.00787)	305 (12.00787)	305 (12.00787)	548 (21.5748)
• Height	mm (in)	999 (39.33071)	999 (39.33071)	999 (39.33071)	1695 (66.73228)
• Depth	mm (in)	360 (14.17323)	360 (14.17323)	360 (14.17323)	393 (15.47244)
• Depth, with operator panel	mm (in)	369 (14.52756)	369 (14.52756)	369 (14.52756)	393 (15.47244)
Frame size		FSG	FSG	FSG	FSH
Weight, approx.	kg (lb)	105 (231.48536)	113 (249.12234)	120 (264.5547)	151 (332.89799)

<sup>1)</sup> Typical values. More information can be found on the internet at <https://support.industry.siemens.com/cs/document/94059311>

<sup>2)</sup> The values apply with compliance to the EMC category C3. For more information, see Maximum permissible motor cable lengths SINAMICS G120X and on the internet at [www.siemens.com/sinamics-g120x/documentation](http://www.siemens.com/sinamics-g120x/documentation)

# SINAMICS G120X infrastructure converters for HVAC/Water/Wastewater

0.75 kW to 630 kW (1 hp to 700 hp)

## SINAMICS G120X infrastructure converters for HVAC/Water/Wastewater

### Technical specifications

		6SL3220-.YE58-.C.0	6SL3220-.YE60-.C.0	6SL3220-.YE62-.C.0	6SL3220-.YE64-.C.0	6SL3220-.YE66-.C.0
Type of voltage		3 AC	3 AC	3 AC	3 AC	3 AC
Line voltage	V	380 ... 480	380 ... 480	380 ... 480	380 ... 480	380 ... 480
Output current at line voltage 400 V						
• without overload rated value	A	655	735	840	910	1021
• with low overload rated value	A	640	720	820	890	1000
• with high overload rated value	A	491	551	672	728	786
• maximum	A	864	972	1107	1202	1350
Supplied active power at rated value of output voltage and at line voltage 400 V						
• with low overload	kW	355	400	450	500	560
• with high overload	kW	250	315	355	400	450
Supplied active power [hp] at rated value of output voltage and at line voltage 480 V						
• with low overload	hp	450	500	500	600	700
• with high overload	hp	300	350	450	500	500
Pulse frequency	kHz	4	4	4	4	4
Efficiency		0.98	0.98	0.98	0.98	0.98
Power loss maximum <sup>1)</sup>	kW	7.687	8.385	10.418	10.885	12.496
Cooling air flow	m <sup>3</sup> /s (ft <sup>3</sup> /h)	0.362 (46022.07788)	0.362 (46022.07788)	0.45 (57209.76533)	0.45 (57209.76533)	0.45 (57209.76533)
1 m measuring surface sound pressure level maximum	dB	74	74	74	74	74
Input current at line voltage 400 V						
• with low overload rated value	A	654	735	850	924	1038
• with high overload rated value	A	501	562	696	756	816
for mains supply line						
• Type of electrical connection		M12 screw	M12 screw	M12 screw	M12 screw	M12 screw
• Number of connections		4	4	6	6	6
• Connectable conductor cross-section	mm <sup>2</sup>	240 ... 240	240 ... 240	240 ... 240	240 ... 240	240 ... 240
• as coded connectable conductor cross section		MCM 2 × 500 ... MCM 4 × 500	MCM 2 × 500 ... MCM 4 × 500	MCM 4 × 500 ... MCM 6 × 500	MCM 4 × 500 ... MCM 6 × 500	MCM 4 × 500 ... MCM 6 × 500
for motor supply line						
• Type of electrical connection		M12 screw	M12 screw	M12 screw	M12 screw	M12 screw
• Number of connections		4	4	6	6	6
• Connectable conductor cross-section	mm <sup>2</sup>	240 ... 240	240 ... 240	240 ... 240	240 ... 240	240 ... 240
• as coded connectable conductor cross section		MCM 2 × 500 ... MCM 4 × 500	MCM 2 × 500 ... MCM 4 × 500	MCM 4 × 500 ... MCM 8 × 500	MCM 4 × 500 ... MCM 8 × 500	MCM 4 × 500 ... MCM 8 × 500
Type of electrical connection for PE conductor		M12 screw	M12 screw	M12 screw	M12 screw	M12 screw
Cable length for motor						
• shielded maximum <sup>2)</sup>	m (ft)	150 (492.12598)	150 (492.12598)	150 (492.12598)	150 (492.12598)	150 (492.12598)
Dimensions						
• Width	mm (in)	548 (21.5748)	548 (21.5748)	801 (31.53543)	801 (31.53543)	801 (31.53543)
• Height	mm (in)	1695 (66.73228)	1695 (66.73228)	1621 (63.8189)	1621 (63.8189)	1621 (63.8189)
• Depth	mm (in)	393 (15.47244)	393 (15.47244)	393 (15.47244)	393 (15.47244)	393 (15.47244)
• Depth, with operator panel	mm (in)	393 (15.47244)	393 (15.47244)	393 (15.47244)	393 (15.47244)	393 (15.47244)
Frame size		FSH	FSH	FSJ	FSJ	FSJ
Weight, approx.	kg (lb)	157 (346.12573)	159 (350.53497)	236 (520.2909)	250 (551.15562)	250 (551.15562)

<sup>1)</sup> Typical values. More information can be found on the internet at <https://support.industry.siemens.com/cs/document/94059311>

<sup>2)</sup> The values apply with compliance to the EMC category. For more information, see Maximum permissible motor cable lengths SINAMICS G120X and on the internet at [www.siemens.com/sinamics-g120x/documentation](http://www.siemens.com/sinamics-g120x/documentation)

# SINAMICS G120X infrastructure converters for HVAC/Water/Wastewater

0.75 kW to 630 kW (1 hp to 700 hp)

## SINAMICS G120X infrastructure converters for HVAC/Water/Wastewater

### Technical specifications

#### SINAMICS G120X converters · Degree of protection IP20/UL Open Type · 500 ... 690 V 3 AC

		6SL32.0-.YH18-.A.0 6SL32.0-.YH18-.U.0	6SL32.0-.YH20-.A.0 6SL32.0-.YH20-.U.0	6SL32.0-.YH22-.A.0 6SL32.0-.YH22-.U.0	6SL32.0-.YH24-.A.0 6SL32.0-.YH24-.U.0
Type of voltage		3 AC	3 AC	3 AC	3 AC
Line voltage	V	500 ... 690	500 ... 690	500 ... 690	500 ... 690
Output current at line voltage 690 V					
• without overload rated value	A	6	7	10	12
• with low overload rated value	A	5	6.3	9	11
• with high overload rated value	A	4	5	6.3	9
• maximum	A	7	9	13	15
Supplied active power at rated value of output voltage and at line voltage 690 V					
• with low overload	kW	3	4	5.5	7.5
• with high overload	kW	2.2	3	4	5.5
Supplied active power [hp] at rated value of output voltage and at line voltage 600 V					
• with low overload	hp	4	5	7.5	10
• with high overload	hp	3	4	5	7.5
Pulse frequency	kHz	2	2	2	2
Efficiency		0.98	0.98	0.98	0.98
Power loss maximum <sup>1)</sup>	kW	0.35	0.35	0.35	0.35
Cooling air flow	m <sup>3</sup> /s (ft <sup>3</sup> /h)	0.055 (6992.30465)	0.055 (6992.30465)	0.055 (6992.30465)	0.055 (6992.30465)
1 m measuring surface sound pressure level maximum	dB	70	70	70	70
Input current at line voltage 690 V					
• with low overload rated value	A	5	6	9	11
• with high overload rated value	A	4.4	5.2	6.9	9.9
for mains supply line					
• Type of electrical connection		Screw-type terminals	Screw-type terminals	Screw-type terminals	Screw-type terminals
• Number of connections		1	1	1	1
• Connectable conductor cross-section	mm <sup>2</sup>	10 ... 35	10 ... 35	10 ... 35	10 ... 35
• as coded connectable conductor cross section		AWG 8 ... AWG 2	AWG 8 ... AWG 2	AWG 8 ... AWG 2	AWG 8 ... AWG 2
for motor supply line					
• Type of electrical connection		Screw-type terminals	Screw-type terminals	Screw-type terminals	Screw-type terminals
• Number of connections		1	1	1	1
• Connectable conductor cross-section	mm <sup>2</sup>	10 ... 35	10 ... 35	10 ... 35	10 ... 35
• as coded connectable conductor cross section		AWG 8 ... AWG 2	AWG 8 ... AWG 2	AWG 8 ... AWG 2	AWG 8 ... AWG 2
Type of electrical connection for PE conductor		Screw-type terminals	Screw-type terminals	Screw-type terminals	Screw-type terminals
Cable length for motor					
• shielded maximum <sup>2)</sup>	m (ft)	200 (656.16798)	200 (656.16798)	200 (656.16798)	200 (656.16798)
• unshielded maximum <sup>2)</sup>	m (ft)	300 (984.25197)	300 (984.25197)	300 (984.25197)	300 (984.25197)
Dimensions					
• Width	mm (in)	200 (7.87402)	200 (7.87402)	200 (7.87402)	200 (7.87402)
• Height	mm (in)	472 (18.58268)	472 (18.58268)	472 (18.58268)	472 (18.58268)
• Depth	mm (in)	239 (9.40945)	239 (9.40945)	239 (9.40945)	239 (9.40945)
• Depth, with operator panel	mm (in)	248 (9.76378)	248 (9.76378)	248 (9.76378)	248 (9.76378)
Frame size		FSD	FSD	FSD	FSD
Weight, approx. <sup>3)</sup>	kg (lb)	16.6 (36.59669)	16.6 (36.59669)	16.6 (36.59669)	16.6 (36.59669)

<sup>1)</sup> Typical values. More information can be found on the internet at <https://support.industry.siemens.com/cs/document/94059311>

<sup>2)</sup> The values apply without compliance to the EMC category. For more information, see Maximum permissible motor cable lengths SINAMICS G120X and on the internet at [www.siemens.com/sinamics-g120x/documentation](http://www.siemens.com/sinamics-g120x/documentation)

<sup>3)</sup> The values apply for converters without integrated line filter. For more information, see on the internet at [www.siemens.com/sinamics-g120x/documentation](http://www.siemens.com/sinamics-g120x/documentation)



# SINAMICS G120X infrastructure converters for HVAC/Water/Wastewater

0.75 kW to 630 kW (1 hp to 700 hp)

## SINAMICS G120X infrastructure converters for HVAC/Water/Wastewater

### Technical specifications

		6SL32.0-.YH26-.A.0 6SL32.0-.YH26-.U.0	6SL32.0-.YH28-.A.0 6SL32.0-.YH28-.U.0	6SL32.0-.YH30-.A.0 6SL32.0-.YH30-.U.0	6SL32.0-.YH32-.A.0 6SL32.0-.YH32-.U.0
Type of voltage		3 AC	3 AC	3 AC	3 AC
Line voltage	V	500 ... 690	500 ... 690	500 ... 690	500 ... 690
Output current at line voltage 690 V					
• without overload rated value	A	15	20	24	28
• with low overload rated value	A	14	19	23	27
• with high overload rated value	A	11	14	19	23
• maximum	A	19	26	32	37
Supplied active power at rated value of output voltage and at line voltage 690 V					
• with low overload	kW	11	15	18.5	22
• with high overload	kW	7.5	11	15	18.5
Supplied active power [hp] at rated value of output voltage and at line voltage 600 V					
• with low overload	hp	10	15	20	25
• with high overload	hp	10	10	15	20
Pulse frequency	kHz	2	2	2	2
Efficiency		0.98	0.98	0.98	0.98
Power loss maximum <sup>1)</sup>	kW	0.35	0.45	0.52	0.6
Cooling air flow	m <sup>3</sup> /s (ft <sup>3</sup> /h)	0.055 (6992.30465)	0.055 (6992.30465)	0.055 (6992.30465)	0.055 (6992.30465)
1 m measuring surface sound pressure level maximum	dB	70	70	70	70
Input current at line voltage 690 V					
• with low overload rated value	A	14	18	22	25
• with high overload rated value	A	12.1	14.6	20	23.4
for mains supply line					
• Type of electrical connection		Screw-type terminals	Screw-type terminals	Screw-type terminals	Screw-type terminals
• Number of connections		1	1	1	1
• Connectable conductor cross-section	mm <sup>2</sup>	10 ... 35	10 ... 35	10 ... 35	10 ... 35
• as coded connectable conductor cross section		AWG 8 ... AWG 2	AWG 8 ... AWG 2	AWG 8 ... AWG 2	AWG 8 ... AWG 2
for motor supply line					
• Type of electrical connection		Screw-type terminals	Screw-type terminals	Screw-type terminals	Screw-type terminals
• Number of connections		1	1	1	1
• Connectable conductor cross-section	mm <sup>2</sup>	10 ... 35	10 ... 35	10 ... 35	10 ... 35
• as coded connectable conductor cross section		AWG 8 ... AWG 2	AWG 8 ... AWG 2	AWG 8 ... AWG 2	AWG 8 ... AWG 2
Type of electrical connection for PE conductor		Screw-type terminals	Screw-type terminals	Screw-type terminals	Screw-type terminals
Cable length for motor					
• shielded maximum <sup>2)</sup>	m (ft)	200 (656.16798)	200 (656.16798)	200 (656.16798)	200 (656.16798)
• unshielded maximum <sup>2)</sup>	m (ft)	300 (984.25197)	300 (984.25197)	300 (984.25197)	300 (984.25197)
Dimensions					
• Width	mm (in)	200 (7.87402)	200 (7.87402)	200 (7.87402)	200 (7.87402)
• Height	mm (in)	472 (18.58268)	472 (18.58268)	472 (18.58268)	472 (18.58268)
• Depth	mm (in)	239 (9.40945)	239 (9.40945)	239 (9.40945)	239 (9.40945)
• Depth, with operator panel	mm (in)	248 (9.76378)	248 (9.76378)	248 (9.76378)	248 (9.76378)
Frame size		FSD	FSD	FSD	FSD
Weight, approx. <sup>3)</sup>	kg (lb)	16.6 (36.59669)	16.6 (36.59669)	16.6 (36.59669)	16.6 (36.59669)

<sup>1)</sup> Typical values. More information can be found on the internet at <https://support.industry.siemens.com/cs/document/94059311>

<sup>2)</sup> The values apply without compliance to the EMC category. For more information, see Maximum permissible motor cable lengths SINAMICS G120X and on the internet at [www.siemens.com/sinamics-g120x/documentation](http://www.siemens.com/sinamics-g120x/documentation)

<sup>3)</sup> The values apply for converters without integrated line filter. For more information, see on the internet at [www.siemens.com/sinamics-g120x/documentation](http://www.siemens.com/sinamics-g120x/documentation)

# SINAMICS G120X infrastructure converters for HVAC/Water/Wastewater

0.75 kW to 630 kW (1 hp to 700 hp)

## SINAMICS G120X infrastructure converters for HVAC/Water/Wastewater

### Technical specifications

		6SL32.0-.YH34-.A.0 6SL32.0-.YH34-.U.0	6SL32.0-.YH36-.A.0 6SL32.0-.YH36-.U.0	6SL32.0-.YH38-.U.0 6SL32.0-.YH38-.A.0	6SL32.0-.YH40-.A.0 6SL32.0-.YH40-.U.0
Type of voltage		3 AC	3 AC	3 AC	3 AC
Line voltage	V	500 ... 690	500 ... 690	500 ... 690	500 ... 690
Output current at line voltage 690 V					
• without overload rated value	A	36	43	54	64
• with low overload rated value	A	35	42	52	62
• with high overload rated value	A	27	35	42	52
• maximum	A	48	57	71	84
Supplied active power at rated value of output voltage and at line voltage 690 V					
• with low overload	kW	30	37	45	55
• with high overload	kW	22	30	37	45
Supplied active power [hp] at rated value of output voltage and at line voltage 600 V					
• with low overload	hp	30	40	50	60
• with high overload	hp	25	30	40	50
Pulse frequency	kHz	2	2	2	2
Efficiency		0.98	0.98	0.98	0.98
Power loss maximum <sup>1)</sup>	kW	0.78	0.94	1.08	1.31
Cooling air flow	m <sup>3</sup> /s (ft <sup>3</sup> /h)	0.055 (6992.30465)	0.055 (6992.30465)	0.083 (10552.02338)	0.083 (10552.02338)
1 m measuring surface sound pressure level maximum	dB	70	70	70	70
Input current at line voltage 690 V					
• with low overload rated value	A	33	40	50	59
• with high overload rated value	A	28	36.6	44.4	54.4
for mains supply line					
• Type of electrical connection		Screw-type terminals	Screw-type terminals	Screw-type terminals	Screw-type terminals
• Number of connections		1	1	1	1
• Connectable conductor cross-section	mm <sup>2</sup>	10 ... 35	10 ... 35	25 ... 70	25 ... 70
• as coded connectable conductor cross section		AWG 8 ... AWG 2	AWG 8 ... AWG 2	AWG 6 ... AWG 3/0	AWG 6 ... AWG 3/0
for motor supply line					
• Type of electrical connection		Screw-type terminals	Screw-type terminals	Screw-type terminals	Screw-type terminals
• Number of connections		1	1	1	1
• Connectable conductor cross-section	mm <sup>2</sup>	10 ... 35	10 ... 35	25 ... 70	25 ... 70
• as coded connectable conductor cross section		AWG 8 ... AWG 2	AWG 8 ... AWG 2	AWG 6 ... AWG 3/0	AWG 6 ... AWG 3/0
Type of electrical connection for PE conductor		Screw-type terminals	Screw-type terminals	Screw-type terminals	Screw-type terminals
Cable length for motor					
• shielded maximum <sup>2)</sup>	m (ft)	200 (656.16798)	300 (984.25197)	300 (984.25197)	300 (984.25197)
• unshielded maximum <sup>2)</sup>	m (ft)	300 (984.25197)	450 (1476.37795)	450 (1476.37795)	450 (1476.37795)
Dimensions					
• Width	mm (in)	200 (7.87402)	200 (7.87402)	275 (10.82677)	275 (10.82677)
• Height	mm (in)	472 (18.58268)	472 (18.58268)	551 (21.69291)	551 (21.69291)
• Depth	mm (in)	239 (9.40945)	239 (9.40945)	239 (9.40945)	239 (9.40945)
• Depth, with operator panel	mm (in)	248 (9.76378)	248 (9.76378)	248 (9.76378)	248 (9.76378)
Frame size		FSD	FSD	FSE	FSE
Weight, approx. <sup>3)</sup>	kg (lb)	16.6 (36.59669)	18.8 (41.44686)	26.7 (58.86342)	26.7 (58.86342)

<sup>1)</sup> Typical values. More information can be found on the internet at <https://support.industry.siemens.com/cs/document/94059311>

<sup>2)</sup> The values apply without compliance to the EMC category. For more information, see Maximum permissible motor cable lengths SINAMICS G120X and on the internet at [www.siemens.com/sinamics-g120x/documentation](http://www.siemens.com/sinamics-g120x/documentation)

<sup>3)</sup> The values apply for converters without integrated line filter. For more information, see on the internet at [www.siemens.com/sinamics-g120x/documentation](http://www.siemens.com/sinamics-g120x/documentation)

# SINAMICS G120X infrastructure converters for HVAC/Water/Wastewater

0.75 kW to 630 kW (1 hp to 700 hp)

## SINAMICS G120X infrastructure converters for HVAC/Water/Wastewater

### Technical specifications

		6SL32.0-.YH42-.C.0 6SL32.0-.YH42-.U.0	6SL32.0-.YH44-.C.0 6SL32.0-.YH44-.U.0	6SL32.0-.YH46-.C.0 6SL32.0-.YH46-.U.0	6SL32.0-.YH48-.C.0 6SL32.0-.YH48-.U.0
Type of voltage		3 AC	3 AC	3 AC	3 AC
Line voltage	V	500 ... 690	500 ... 690	500 ... 690	500 ... 690
Output current at line voltage 690 V					
• without overload rated value	A	82	103	128	148
• with low overload rated value	A	80	100	125	144
• with high overload rated value	A	62	80	100	125
• maximum	A	108	135	169	195
Supplied active power at rated value of output voltage and at line voltage 690 V					
• with low overload	kW	75	90	110	132
• with high overload	kW	55	75	90	110
Supplied active power [hp] at rated value of output voltage and at line voltage 600 V					
• with low overload	hp	75	100	125	150
• with high overload	hp	60	75	100	125
Pulse frequency	kHz	2	2	2	2
Efficiency		0.98	0.98	0.98	0.98
Power loss maximum <sup>1)</sup>	kW	1.38	1.76	1.97	2.51
Cooling air flow	m <sup>3</sup> /s (ft <sup>3</sup> /h)	0.153 (19451.32021)	0.153 (19451.32021)	0.153 (19451.32021)	0.153 (19451.32021)
1 m measuring surface sound pressure level maximum	dB	72	72	72	72
Input current at line voltage 690 V					
• with low overload rated value	A	78	97	121	138
• with high overload rated value	A	66.4	85.2	106.3	131.6
for mains supply line					
• Type of electrical connection		M10 screw	M10 screw	M10 screw	M10 screw
• Number of connections		2	2	2	2
• Connectable conductor cross-section	mm <sup>2</sup>	35 ... 120	35 ... 120	35 ... 120	35 ... 120
• as coded connectable conductor cross section		AWG 1 ... AWG 2 × 4/0	AWG 1 ... AWG 2 × 4/0	AWG 1 ... AWG 2 × 4/0	AWG 1 ... AWG 2 × 4/0
for motor supply line					
• Type of electrical connection		M10 screw	M10 screw	M10 screw	M10 screw
• Number of connections		2	2	2	2
• Connectable conductor cross-section	mm <sup>2</sup>	35 ... 120	35 ... 120	35 ... 120	35 ... 120
• as coded connectable conductor cross section		AWG 1 ... AWG 2 × 4/0	AWG 1 ... AWG 2 × 4/0	AWG 1 ... AWG 2 × 4/0	AWG 1 ... AWG 2 × 4/0
Type of electrical connection for PE conductor		M10 screw	M10 screw	M10 screw	M10 screw
Cable length for motor					
• shielded maximum <sup>2)</sup>	m (ft)	300 (984.25197)	300 (984.25197)	300 (984.25197)	300 (984.25197)
• unshielded maximum <sup>2)</sup>	m (ft)	450 (1476.37795)	450 (1476.37795)	450 (1476.37795)	450 (1476.37795)
Dimensions					
• Width	mm (in)	305 (12.00787)	305 (12.00787)	305 (12.00787)	305 (12.00787)
• Height	mm (in)	709 (27.91339)	709 (27.91339)	709 (27.91339)	709 (27.91339)
• Depth	mm (in)	360 (14.17323)	360 (14.17323)	360 (14.17323)	360 (14.17323)
• Depth, with operator panel	mm (in)	369 (14.52756)	369 (14.52756)	369 (14.52756)	369 (14.52756)
Frame size		FSF	FSF	FSF	FSF
Weight, approx. <sup>3)</sup>	kg (lb)	61 (134.48182)	61 (134.48182)	66.5 (146.60723)	66.5 (146.60723)

<sup>1)</sup> Typical values. More information can be found on the internet at <https://support.industry.siemens.com/cs/document/94059311>

<sup>2)</sup> The values apply without compliance to the EMC category. For more information, see Maximum permissible motor cable lengths SINAMICS G120X and on the internet at [www.siemens.com/sinamics-g120x/documentation](http://www.siemens.com/sinamics-g120x/documentation)

<sup>3)</sup> The values apply for converters without integrated line filter. For more information, see on the internet at [www.siemens.com/sinamics-g120x/documentation](http://www.siemens.com/sinamics-g120x/documentation)

## SINAMICS G120X infrastructure converters for HVAC/Water/Wastewater

0.75 kW to 630 kW (1 hp to 700 hp)

### SINAMICS G120X infrastructure converters for HVAC/Water/Wastewater

#### Technical specifications

		6SL32.0-.YH50-.C.0	6SL32.0-.YH52-.C.0	6SL32.0-.YH54-.C.0	6SL3220-.YH56-.C.0	6SL3220-.YH58-.C.0
Type of voltage		3 AC	3 AC	3 AC	3 AC	3 AC
Line voltage	V	500 ... 690	500 ... 690	500 ... 690	500 ... 690	500 ... 690
Output current at line voltage 690 V						
• without overload rated value	A	175	213	256	368	400
• with low overload rated value	A	171	208	250	330	385
• with high overload rated value	A	144	171	208	272	314
• maximum	A	231	281	338	487	529
Supplied active power at rated value of output voltage and at line voltage 690 V						
• with low overload	kW	160	200	250	315	355
• with high overload	kW	132	160	200	250	315
Supplied active power [hp] at rated value of output voltage and at line voltage 600 V						
• with low overload	hp	150	200	250	350	400
• with high overload	hp	150	150	200	250	300
Pulse frequency	kHz	2	2	2	2	2
Efficiency		0.98	0.98	0.98	0.98	0.98
Power loss maximum <sup>1)</sup>	kW	2.94	3.7	4.64	5.402	6.191
Cooling air flow	m <sup>3</sup> /s (ft <sup>3</sup> /h)	0.21 (26697.89049)	0.21 (26697.89049)	0.21 (26697.89049)	0.362 (46022.07788)	0.362 (46022.07788)
1 m measuring surface sound pressure level maximum	dB	74	74	74	74	74
Input current at line voltage 690 V						
• with low overload rated value	A	171	205	249	343	401
• with high overload rated value	A	158.2	185.1	227.5	283	327
for mains supply line						
• Type of electrical connection		M10 screw	M10 screw	M10 screw	M12 screw	M12 screw
• Number of connections		2	2	2	4	4
• Connectable conductor cross-section	mm <sup>2</sup>	35 ... 185	35 ... 185	35 ... 185	240 ... 240	240 ... 240
• as coded connectable conductor cross section		AWG 1 ... MCM 2 × 350	AWG 1 ... MCM 2 × 350	AWG 1 ... MCM 2 × 350	MCM 2 × 500 ... MCM 4 × 500	MCM 2 × 500 ... MCM 4 × 500
for motor supply line						
• Type of electrical connection		M10 screw	M10 screw	M10 screw	M12 screw	M12 screw
• Number of connections		2	2	2	4	4
• Connectable conductor cross-section	mm <sup>2</sup>	35 ... 185	35 ... 185	35 ... 185	240 ... 240	240 ... 240
• as coded connectable conductor cross section		AWG 1 ... MCM 2 × 350	AWG 1 ... MCM 2 × 350	AWG 1 ... MCM 2 × 350	MCM 2 × 500 ... MCM 4 × 500	MCM 2 × 500 ... MCM 4 × 500
Type of electrical connection for PE conductor		M10 screw	M10 screw	M10 screw	M12 screw	M12 screw
Cable length for motor						
• shielded maximum <sup>2)</sup>	m (ft)	150 (492.12598)	150 (492.12598)	150 (492.12598)	150 (492.12598)	150 (492.12598)
Dimensions						
• Width	mm (in)	305 (12.00787)	305 (12.00787)	305 (12.00787)	548 (21.5748)	548 (21.5748)
• Height	mm (in)	999 (39.33071)	999 (39.33071)	999 (39.33071)	1695 (66.73228)	1695 (66.73228)
• Depth	mm (in)	360 (14.17323)	360 (14.17323)	360 (14.17323)	393 (15.47244)	393 (15.47244)
• Depth, with operator panel	mm (in)	369 (14.52756)	369 (14.52756)	369 (14.52756)	393 (15.47244)	393 (15.47244)
Frame size		FSG	FSG	FSG	FSH	FSH
Weight, approx.	kg (lb)	105 (231.48536)	113 (249.12234)	120 (264.5547)	158 (348.33035)	158 (348.33035)

<sup>1)</sup> Typical values. More information can be found on the internet at <https://support.industry.siemens.com/cs/document/94059311>

<sup>2)</sup> The values apply with compliance to the EMC category. For more information, see Maximum permissible motor cable lengths SINAMICS G120X and on the internet at [www.siemens.com/sinamics-g120x/documentation](http://www.siemens.com/sinamics-g120x/documentation)

# SINAMICS G120X infrastructure converters for HVAC/Water/Wastewater

0.75 kW to 630 kW (1 hp to 700 hp)

## SINAMICS G120X infrastructure converters for HVAC/Water/Wastewater

### Technical specifications

		6SL3220-YH60-C.0	6SL3220-YH62-C.0	6SL3220-YH64-C.0	6SL3220-YH66-C.0	6SL3220-YH68-C.0
Type of voltage		3 AC	3 AC	3 AC	3 AC	3 AC
Line voltage	V	500 ... 690	500 ... 690	500 ... 690	500 ... 690	500 ... 690
Output current at line voltage 690 V						
• without overload rated value	A	453	516	581	654	725
• with low overload rated value	A	420	470	520	580	650
• with high overload rated value	A	348	394	444	476	532
• maximum	A	598	682	768	864	959
Supplied active power at rated value of output voltage and at line voltage 690 V						
• with low overload	kW	400	450	500	560	630
• with high overload	kW	355	400	450	500	560
Supplied active power [hp] at rated value of output voltage and at line voltage 600 V						
• with low overload	hp	450	500	500	600	700
• with high overload	hp	350	450	450	500	500
Pulse frequency	kHz	2	2	2	2	2
Efficiency		0.98	0.98	0.98	0.98	0.98
Power loss maximum <sup>1)</sup>	kW	6.884	7.716	8.134	8.828	9.937
Cooling air flow	m <sup>3</sup> /s (ft <sup>3</sup> /h)	0.362 (46022.07788)	0.362 (46022.07788)	0.45 (57209.76533)	0.45 (57209.76533)	0.45 (57209.76533)
1 m measuring surface sound pressure level maximum	dB	74	74	74	74	74
Input current at line voltage 690 V						
• with low overload rated value	A	437	489	540	602	675
• with high overload rated value	A	362	410	461	494	552
for mains supply line						
• Type of electrical connection		M12 screw	M12 screw	M12 screw	M12 screw	M12 screw
• Number of connections		4	4	6	6	6
• Connectable conductor cross-section	mm <sup>2</sup>	240 ... 240	240 ... 240	240 ... 240	240 ... 240	240 ... 240
• as coded connectable conductor cross section		MCM 2 × 500 ... MCM 4 × 500	MCM 2 × 500 ... MCM 4 × 500	MCM 4 × 500 ... MCM 6 × 500	MCM 4 × 500 ... MCM 6 × 500	MCM 4 × 500 ... MCM 6 × 500
for motor supply line						
• Type of electrical connection		M12 screw	M12 screw	M12 screw	M12 screw	M12 screw
• Number of connections		4	4	6	6	6
• Connectable conductor cross-section	mm <sup>2</sup>	240 ... 240	240 ... 240	240 ... 240	240 ... 240	240 ... 240
• as coded connectable conductor cross section		MCM 2 × 500 ... MCM 4 × 500	MCM 2 × 500 ... MCM 4 × 500	MCM 4 × 500 ... MCM 8 × 500	MCM 4 × 500 ... MCM 8 × 500	MCM 4 × 500 ... MCM 8 × 500
Type of electrical connection for PE conductor		M12 screw	M12 screw	M12 screw	M12 screw	M12 screw
Cable length for motor						
• shielded maximum <sup>2)</sup>	m (ft)	150 (492.12598)	150 (492.12598)	150 (492.12598)	150 (492.12598)	150 (492.12598)
Dimensions						
• Width	mm (in)	548 (21.5748)	548 (21.5748)	801 (31.53543)	801 (31.53543)	801 (31.53543)
• Height	mm (in)	1695 (66.73228)	1695 (66.73228)	1621 (63.8189)	1621 (63.8189)	1621 (63.8189)
• Depth	mm (in)	393 (15.47244)	393 (15.47244)	393 (15.47244)	393 (15.47244)	393 (15.47244)
• Depth, with operator panel	mm (in)	393 (15.47244)	393 (15.47244)	393 (15.47244)	393 (15.47244)	393 (15.47244)
Frame size		FSH	FSH	FSJ	FSJ	FSJ
Weight, approx.	kg (lb)	162 (357.14884)	162 (357.14884)	236 (520.2909)	236 (520.2909)	246 (542.33713)

<sup>1)</sup> Typical values. More information can be found on the internet at <https://support.industry.siemens.com/cs/document/94059311>

<sup>2)</sup> The values apply with compliance to the EMC category. For more information, see Maximum permissible motor cable lengths SINAMICS G120X and on the internet at [www.siemens.com/sinamics-g120x/documentation](http://www.siemens.com/sinamics-g120x/documentation)

## SINAMICS G120X infrastructure converters for HVAC/Water/Wastewater

0.75 kW to 630 kW (1 hp to 700 hp)

### SINAMICS G120X infrastructure converters for HVAC/Water/Wastewater

#### Characteristic curves

##### Derating data

##### Pulse frequency

Frame size	Rated power <sup>1)</sup> at 50 Hz 200 V 3 AC		Rated output current <sup>2)</sup> in A (at an ambient temperature of 45 °C (113 °F)) for a pulse frequency of							
	kW	hp	2 kHz	4 kHz	6 kHz	8 kHz	10 kHz	12 kHz	14 kHz	16 kHz
FSA	0.75	1	4.2	<b>4.2</b>	3.5	2.9	2.5	2.1	1.8	1.6
	1.1	1.5	6	<b>6</b>	5.1	4.2	3.6	3	2.7	2.4
	1.5	2	7.4	<b>7.4</b>	6.2	5.1	4.4	3.7	3.3	2.9
FSB	2.2	3	10.4	<b>10.4</b>	8.8	7.2	6.2	5.2	4.6	4.1
	3	4	13.6	<b>13.6</b>	11.5	9.5	8.1	6.8	6.1	5.4
	4	5	17.5	<b>17.5</b>	14.8	12.2	10.4	8.7	7.8	7
FSC	5.5	7.5	22	<b>22</b>	18.7	15.4	13.2	11	9.9	8.8
	7.5	10	28	<b>28</b>	23.8	19.6	16.8	14	12.6	11.2
FSD	11	15	42	<b>42</b>	35.7	29.4	25.2	21	18.9	16.8
	15	20	54	<b>54</b>	45.9	37.8	32.4	27	24.3	21.6
	18.5	25	68	<b>68</b>	57.8	47.6	40.8	34	30.6	27.2
FSE	22	30	80	<b>80</b>	68	56	48	40	36	32
	30	40	104	<b>104</b>	88.4	72.8	62.4	52	46.8	41.6
FSF	37	50	130	<b>130</b>	110.5	91	78	65	58.5	52
	45	60	154	<b>154</b>	130.8	107.8	92.4	77	69.3	61.6
	55	75	192	<b>192</b>	163.2	134.4	115.2	96	86.4	76.8

The rated output currents in **bold** apply for the standard pulse frequency.

<sup>1)</sup> Rated power based on the base-load current  $I_L$ .  
The base-load current  $I_L$  is based on the duty cycle for low overload (LO).

<sup>2)</sup> Output current based on the base-load current  $I_L$ .  
The base-load current  $I_L$  is based on the duty cycle for low overload (LO).

## SINAMICS G120X infrastructure converters for HVAC/Water/Wastewater

0.75 kW to 630 kW (1 hp to 700 hp)

### SINAMICS G120X infrastructure converters for HVAC/Water/Wastewater

#### Characteristic curves

Frame size	Rated power <sup>1)</sup> at 50 Hz 400 V 3 AC		Rated output current <sup>2)</sup> in A (at an ambient temperature of 45 °C (113 °F)) for a pulse frequency of							
	kW	hp	2 kHz	4 kHz	6 kHz	8 kHz	10 kHz	12 kHz	14 kHz	16 kHz
FSA	0.75	1	2.2	<b>2.2</b>	1.87	1.54	1.32	1.1	0.99	0.88
	1.1	1.5	3.1	<b>3.1</b>	2.635	2.17	1.86	1.55	1.395	1.24
	1.5	2	4.1	<b>4.1</b>	3.485	2.87	2.46	2.05	1.895	1.64
	2.2	3	5.9	<b>5.9</b>	5.015	4.13	3.54	2.95	2.655	2.36
	3	4	7.7	<b>7.7</b>	6.545	5.39	4.62	3.85	3.465	3.08
FSB	4	5	10.2	<b>10.2</b>	8.67	7.14	6.12	5.1	4.59	4.08
	5.5	7.5	13.2	<b>13.2</b>	11.22	9.24	7.92	6.6	5.94	5.28
	7.5	10	18	<b>18</b>	15.3	12.6	10.8	9	8.1	7.2
FSC	11	15	26	<b>26</b>	22.1	18.2	15.6	13	11.7	10.4
	15	20	32	<b>32</b>	27.2	22.4	19	18	14.4	12.8
FSD	18.5	25	38	<b>38</b>	32.3	26.6	22.8	19	17.1	15.2
	22	30	45	<b>45</b>	38.2	31.5	27	22.5	20.2	18
	30	40	60	<b>60</b>	51	42	36	30	27	24
	37	50	75	<b>75</b>	63.7	52.5	45	37.5	33.7	30
FSE	45	60	90	<b>90</b>	76.5	63	54	45	40.5	36
	55	75	110	<b>110</b>	93.5	77	66	55	49.5	44
FSF	75	100	145	<b>145</b>	123.2	101.5	87	72.5	65.2	58
	90	125	178	<b>178</b>	151	124.6	107	89	80.1	71.2
	110	150	<b>205</b>	143.5	103	82	–	–	–	–
	132	200	<b>250</b>	175	125	100	–	–	–	–
FSG	160	250	<b>302</b>	211.4	151	121	–	–	–	–
	200	300	<b>370</b>	259	185	148	–	–	–	–
	250	400	<b>477</b>	334	239	191	–	–	–	–
FSH <sup>3)</sup>	315	400	<b>585</b>	468	–	–	–	–	–	–
	355	450	<b>655</b>	524	–	–	–	–	–	–
	400	500	<b>735</b>	588	–	–	–	–	–	–
FSJ <sup>3)</sup>	450	500	<b>840</b>	672	–	–	–	–	–	–
	500	600	<b>910</b>	728	–	–	–	–	–	–
	560	700	<b>1021</b>	817	–	–	–	–	–	–

The rated output currents in **bold** apply for the standard pulse frequency.

<sup>1)</sup> Rated power based on the base-load current  $I_L$ .  
The base-load current  $I_L$  is based on the duty cycle for low overload (LO).

<sup>2)</sup> Frame sizes FSA to FSG:  
Output current based on the base-load current  $I_L$ . The base-load current  $I_L$  is based on the duty cycle for low overload (LO). Frame sizes FSH and FSJ:  
Output current based on the rated output current  $I_N$ . The rated output current  $I_N$  can be used up to 100 %; however, without overload.

<sup>3)</sup> In the factory setting, these converters start at a pulse frequency of 4 kHz and reduce it automatically under load to the associated required frequencies. As the load decreases, the pulse frequency increases automatically up to 4 kHz.

## SINAMICS G120X infrastructure converters for HVAC/Water/Wastewater

0.75 kW to 630 kW (1 hp to 700 hp)

### SINAMICS G120X infrastructure converters for HVAC/Water/Wastewater

#### Characteristic curves

Frame size	Rated power <sup>1)</sup> at 50 Hz 690 V 3 AC		Rated output current in A (at an ambient temperature of 45 °C (113 °F)) for a pulse frequency of							
	kW	hp	2 kHz	4 kHz	6 kHz	8 kHz	10 kHz	12 kHz	14 kHz	16 kHz
FSD	3	4	<b>6</b>	3.6	–	–	–	–	–	–
	4	5	<b>7</b>	4.2	–	–	–	–	–	–
	5.5	7.5	<b>10</b>	6	–	–	–	–	–	–
	7.5	10	<b>13</b>	7.8	–	–	–	–	–	–
	11	10	<b>16</b>	9.6	–	–	–	–	–	–
	15	15	<b>21</b>	12.6	–	–	–	–	–	–
	18.5	20	<b>25</b>	15	–	–	–	–	–	–
	22	25	<b>29</b>	17.4	–	–	–	–	–	–
	30	30	<b>38</b>	22.8	–	–	–	–	–	–
	37	40	<b>46</b>	27.6	–	–	–	–	–	–
FSE	45	50	<b>58</b>	34.8	–	–	–	–	–	–
	55	60	<b>68</b>	40.8	–	–	–	–	–	–
FSF	75	75	<b>90</b>	54	–	–	–	–	–	–
	90	100	<b>112</b>	67.2	–	–	–	–	–	–
	110	125	<b>128</b>	76.8	–	–	–	–	–	–
	132	150	<b>158</b>	94.8	–	–	–	–	–	–
FSG	160	150	<b>196</b>	118	–	–	–	–	–	–
	200	200	<b>236</b>	142	–	–	–	–	–	–
	250	250	<b>288</b>	173	–	–	–	–	–	–
FSH <sup>2)</sup>	315	350	<b>330</b>	215	–	–	–	–	–	–
	355	400	<b>385</b>	250	–	–	–	–	–	–
	400	450	<b>420</b>	273	–	–	–	–	–	–
	450	500	<b>470</b>	306	–	–	–	–	–	–
FSJ <sup>2)</sup>	500	500	<b>520</b>	338	–	–	–	–	–	–
	560	600	<b>580</b>	377	–	–	–	–	–	–
	630	700	<b>650</b>	423	–	–	–	–	–	–

The rated output currents in **bold** apply for the standard pulse frequency.

<sup>1)</sup> Rated power based on the base-load current  $I_L$ .  
The base-load current  $I_L$  is based on the duty cycle for low overload (LO).

<sup>2)</sup> In the factory setting, these converters start at a pulse frequency of 4 kHz and reduce it automatically under load to the associated required frequencies. As the load decreases, the pulse frequency increases automatically up to 4 kHz. The values of the rated currents apply to a pulse frequency of 2 kHz and are reached at any time by automatic adaptation of the output pulse frequency.



# SINAMICS G120X infrastructure converters for HVAC/Water/Wastewater

0.75 kW to 630 kW (1 hp to 700 hp)

## SINAMICS G120X infrastructure converters for HVAC/Water/Wastewater

### Characteristic curves

#### Ambient temperature

##### Frame sizes FSA to FSG:

- Variant PROFINET, Ethernet/IP:

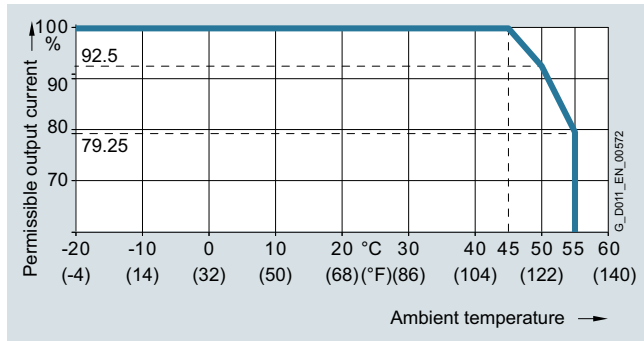

Permissible output current as a function of ambient temperature for SINAMICS G120X, frame sizes FSA to FSG, for low overload (LO)

- Variants PROFIBUS DP and USS, Modbus RTU, BACnet MS/TP:

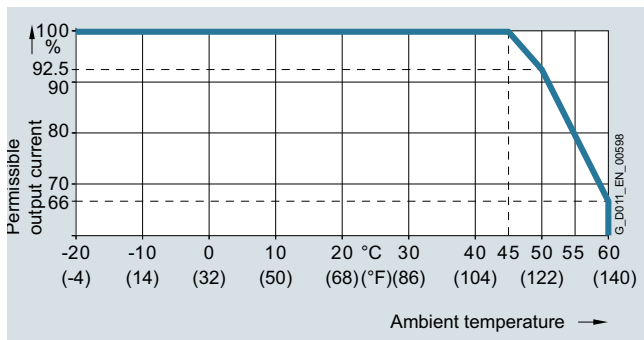

Permissible output current as a function of ambient temperature for SINAMICS G120X, frame sizes FSA to FSG, for low overload (LO)

##### Frame sizes FSH and FSJ:

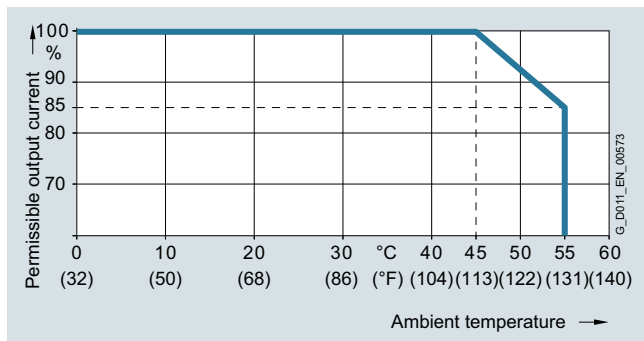

Permissible output current as a function of ambient temperature for SINAMICS G120X, frame sizes FSH and FSJ, for low overload (LO)

The operating temperature ranges of the operator panels should be taken into account. The temperature ranges are specified in the [Technical specifications](#) section under [Operator panels](#).

#### Installation altitude

##### Frame sizes FSA to FSJ:

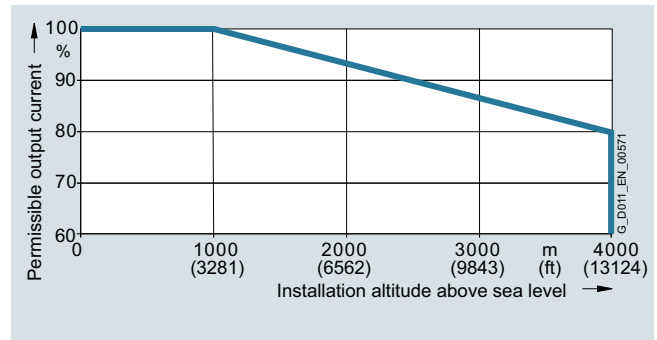

Permissible output current as a function of installation altitude for SINAMICS G120X for low overload (LO)

The connected motors, power elements and components must be considered separately.

Permissible line supplies as a function of the installation altitude

- Installation altitude up to 2000 m (6562 ft) above sea level
  - Connection to every supply system permitted for the converter
- Installation altitudes between 2000 m (6562 ft) and 4000 m (13124 ft) above sea level
  - Connection only to a TN system with grounded neutral point
  - TN systems with grounded line conductor are not permitted
  - The TN line system with grounded neutral point can also be supplied using an isolation transformer
  - The phase-to-phase voltage does not have to be reduced

When using converters on TN systems with voltages  $\geq 600$  V and at installation altitudes of 2000 m to 4000 m, the TN line supply must have a grounded neutral point established using an isolation transformer.

# SINAMICS G120X infrastructure converters for HVAC/Water/Wastewater

0.75 kW to 630 kW (1 hp to 700 hp)

## SINAMICS G120X infrastructure converters for HVAC/Water/Wastewater

### Characteristic curves

#### System operating voltage

#### 200 V converters frame sizes FSA to FSF:

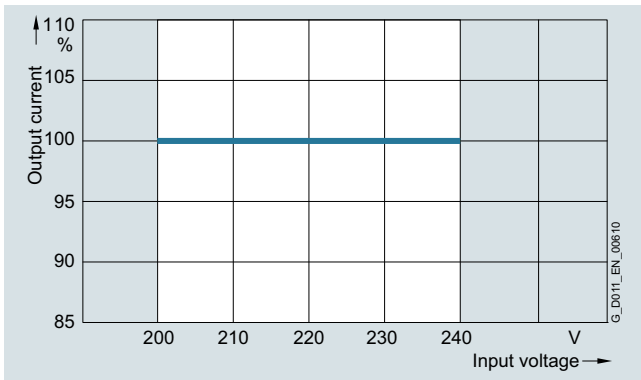

Permissible output current as a function of the input voltage for 200-V-SINAMICS G120X converters frame sizes FSA to FSF

#### 400 V converters frame sizes FSH and FSJ:

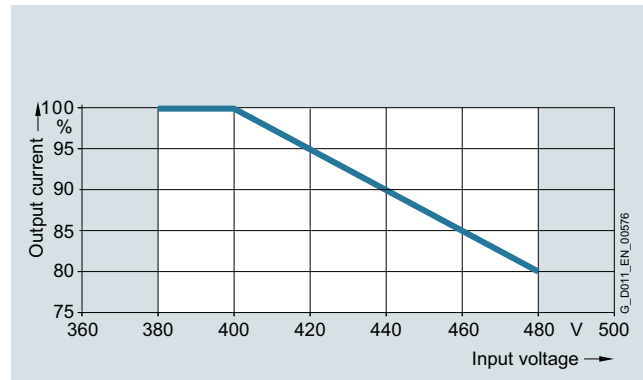

Permissible output current as a function of input voltage for 400 V SINAMICS G120X converters, frame sizes FSH and FSJ, for low overload (LO)

#### 400 V converters frame sizes FSA to FSG:

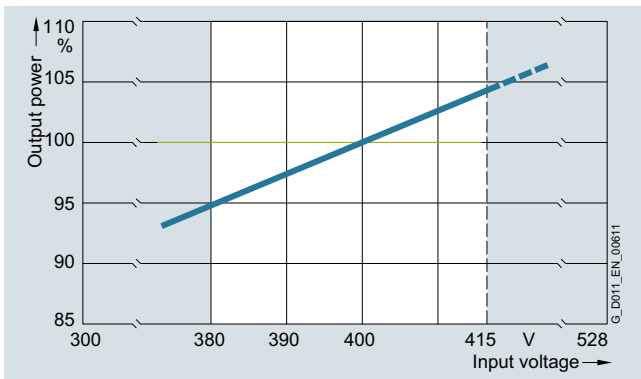

Permissible output power as a function of the input voltage for 400-V-SINAMICS G120X converters frame sizes FSA to FSG at 100% output current in the range of 380 V to 415 V (the temperature protection of the converter can reduce the current or pulse frequency above 415 V)

#### 600 V converters frame sizes FSA to FSG:

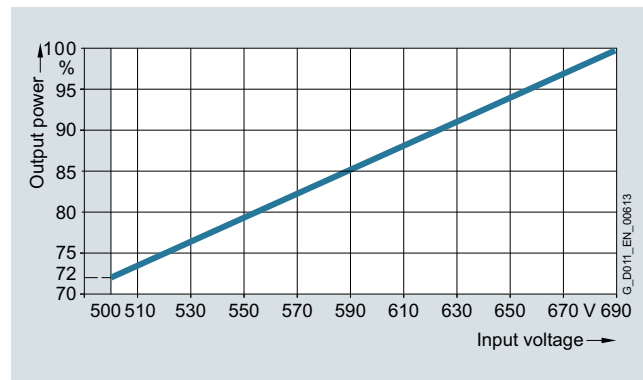

Permissible output power as a function of input voltage for 600-V-SINAMICS G120X converters frame sizes FSA to FSG at 100% output current in the range of 500 V to 690 V

Further information is available in the manual on the internet at: [www.siemens.com/sinamics-g120x/documentation](http://www.siemens.com/sinamics-g120x/documentation)

#### 600 V converters frame sizes FSH and FSJ:

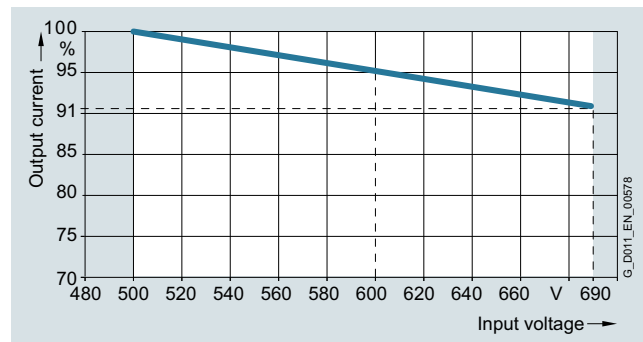

Permissible output current as a function of input voltage for 600 V SINAMICS G120X converters, frame sizes FSH and FSJ, for low overload (LO)

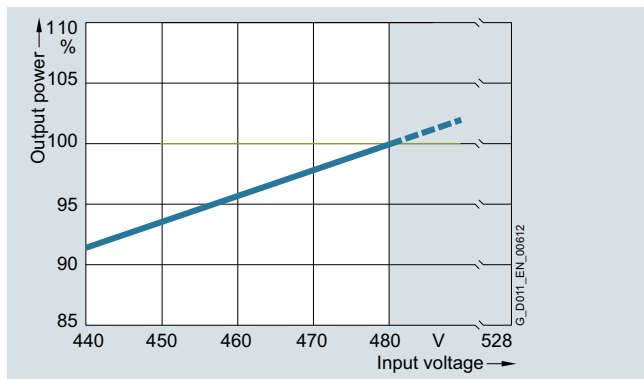

Permissible output power as a function of the input voltage for 400-V-SINAMICS G120X converters frame sizes FSA to FSG at 100% output current in the range of 440 V to 480 V (the temperature protection of the converter can reduce the current or pulse frequency above 480 V)

Further information is available in the manual on the internet at: [www.siemens.com/sinamics-g120x/documentation](http://www.siemens.com/sinamics-g120x/documentation)

2

# SINAMICS G120X infrastructure converters for HVAC/Water/Wastewater

0.75 kW to 630 kW (1 hp to 700 hp)

## SINAMICS G120X infrastructure converters for HVAC/Water/Wastewater

### Dimensional drawings

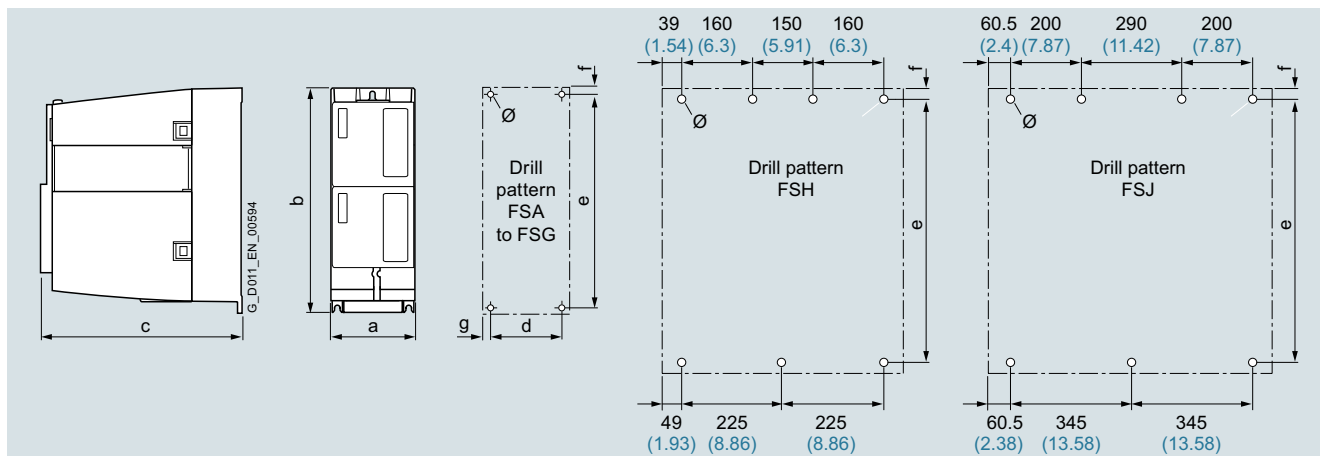

Principle dimension drawing and drill pattern for SINAMICS G120X

Frame size	Dimensions in mm (inches)			Drilling dimensions in mm (inches)					Mounting With screws (plus washers and nuts)	Cooling clearance <sup>2)</sup> in mm (inches)		
	a (width)	b (height)	c (depth) <sup>1)</sup>	d	e	f	g	Ø		top	bottom	front
FSA	73 (2.87)	232 (9.13)	209 (8.23)	55 (2.17)	221.5 (8.72)	5.5 (0.22)	9 (0.35)	5 (0.2)	4 × M4	80 (3.15)	100 (3.94)	0 (0)
FSB	100 (3.94)	275 (10.83)	209 (8.23)	80 (3.15)	265 (10.43)	7 (0.28)	10 (0.39)	5 (0.2)	4 × M4	80 (3.15)	100 (3.94)	0 (0)
FSC	140 (5.51)	295 (11.61)	209 (8.23)	118 (4.65)	283 (11.14)	7 (0.28)	11 (0.43)	5.5 (0.22)	4 × M5	80 (3.15)	100 (3.94)	0 (0)
FSD	200 (7.87)	472 (18.58)	239 (9.41)	170 (6.69)	430 (16.93)	15 (0.59)	15 (0.59)	6 (0.24)	4 × M5	300 (11.81)	350 (13.78)	0 (0)
FSE	275 (10.83)	551 (21.69)	239 (9.41)	230 (9.06)	509 (20.04)	11 (0.43)	22.5 (0.89)	6.5 (0.26)	4 × M6	300 (11.81)	350 (13.78)	0 (0)
FSF	305 (12.01)	709 (27.91)	360 (14.17)	270 (10.63)	680 (26.77)	16.6 (0.65)	17.5 (0.69)	8.5 (0.33)	4 × M8	300 (11.81)	350 (13.78)	0 (0)
FSG	305 (12.01)	999 (39.33)	360 (14.17)	265 (10.43)	970.5 (38.21)	18.5 (0.73)	20 (0.79)	12 (0.47)	4 × M10	300 (11.81)	350 (13.78)	0 (0)
FSH	548 (21.57)	1695 (66.73)	393 (15.47)	see above	1419 (55.87)	21 (0.83)	see above	20 (0.79)	7 × M8	0 (0)	250 (9.84)	100 (3.94)
FSJ	801 (31.54)	1621 (63.82)	393 (15.47)	see above	1399 (55.08)	21 (0.83)	see above	20 (0.79)	7 × M8	0 (0)	250 (9.84)	100 (3.94)

### More information

**Compact Installation Instructions** are supplied in hard copy form in German and English with every SINAMICS G120X. Further documentation, such as the operating instructions, is available free on the internet at:

[www.siemens.com/sinamics-g120x/documentation](http://www.siemens.com/sinamics-g120x/documentation)

Detailed information on the SINAMICS G120X infrastructure converters for HVAC/Water/Wastewater, including the latest technical documentation (brochures, tutorials, dimensional drawings, certificates and operating instructions), is available on the internet at:

[www.siemens.com/sinamics-g120x](http://www.siemens.com/sinamics-g120x)

and is also available via the Drive Technology Configurator (DT Configurator) on the internet.

The DT Configurator can be found in the Siemens Industry Mall at the following address:

[www.siemens.com/dt-configurator](http://www.siemens.com/dt-configurator)

<sup>1)</sup> Increased depth for frame sizes FSA to FSG:

- When the operator panel is plugged on, the depth increases by 9 mm (0.35 in)
- When SINAMICS G120 Smart Access is plugged on, the depth increases by 7 mm (0.28 in)
- When the I/O Extension Module is plugged on, the depth increases by 27 mm (1.06 in)
  - when, in addition, the operator panel is plugged on, the depth increases by a further 11.8 mm (0.46 in)
  - when, in addition, SINAMICS G120 Smart Access is plugged on, the depth increases by a further 9.8 mm (0.39 in)

<sup>2)</sup> The converters in frame sizes FSA to FSG can be mounted side by side. A side clearance of 1 mm (0.04 in) is recommended for tolerance-related reasons. A side clearance of 30 mm (1.18 in) is required between the converters for frame sizes FSH and FSJ.

## SINAMICS G120X infrastructure converters for HVAC/Water/Wastewater

0.75 kW to 630 kW (1 hp to 700 hp)

### Supplementary system components > Operator panels

#### Overview

Operator panel	IOP-2 and IOP-2 Handheld Intelligent Operator Panel	BOP-2 Basic Operator Panel
Description		
	<p>Thanks to the high-contrast color display, menu-based operation and the wizards, commissioning of the standard drives is easy. Application wizards guide the user through the commissioning of important applications such as pumps, fans, compressors, or conveyor systems.</p>	<p>Commissioning of standard drives is easy with the menu-prompted dialog on a 2-line display. Simultaneous display of the parameter and parameter value, as well as parameter filtering, means that basic commissioning of a drive can be performed easily and, in most cases, without a printed parameter list.</p>
Possible applications	<ul style="list-style-type: none"> <li>• Can be mounted directly on the converter</li> <li>• Can be mounted in a control cabinet door using a door mounting kit (achievable degree of protection is IP55/UL Type 12 enclosure)</li> <li>• Environmental class/harmful chemical substances Class 3C3 acc. to IEC 60721-3-3: 2002</li> <li>• Available as handheld version</li> <li>• The following languages are integrated in the IOP-2: English, German, French, Italian, Spanish, Portuguese, Dutch, Swedish, Finnish, Russian, Czech, Polish, Turkish, Chinese Simplified</li> </ul>	<ul style="list-style-type: none"> <li>• Can be mounted directly on the converter</li> <li>• Can be mounted in the control cabinet door using a door mounting kit (achievable degree of protection is IP55/UL Type 12)</li> <li>• Environmental class/harmful chemical substances Class 3C3 acc. to IEC 60721-3-3: 2002</li> </ul>
Quick commissioning without expert knowledge	<ul style="list-style-type: none"> <li>• Standard commissioning using the clone function</li> <li>• For quicker access, the parameter block names can be directly entered respectively changed on the IOP-2 using the virtual keyboard.</li> <li>• User-defined parameter list with a reduced number of self-selected parameters</li> <li>• Simple commissioning of standard applications using Quick Startup and Advanced Startup; it is not necessary to know the parameter structure</li> <li>• Simple local commissioning using the handheld version</li> <li>• Commissioning is possible largely without documentation</li> </ul>	<ul style="list-style-type: none"> <li>• Standard commissioning using the clone function</li> </ul>
High degree of operator friendliness and intuitive operation	<ul style="list-style-type: none"> <li>• Intuitive navigation by operating with a sensor control field</li> <li>• Graphic color display to show status values such as pressure or flow rate in the form of scalar values, bar-type diagrams, or trend displays</li> <li>• Status display with freely selectable units to specify physical values</li> <li>• Direct manual operation of the drive – you can simply toggle between the automatic and manual modes</li> <li>• Simple cloning of specific settings of the IOP-2 user interface.</li> </ul>	<ul style="list-style-type: none"> <li>• 2-line display for showing up to 2 process values with text</li> <li>• Status display of predefined units</li> <li>• Direct manual operation of the drive – you can simply toggle between the automatic and manual modes</li> </ul>
Minimization of maintenance times	<ul style="list-style-type: none"> <li>• Diagnostics using plain text display, can be used locally on-site without documentation</li> <li>• The support function is used to determine the drive data for the Power Module, Control Unit and IOP-2 and makes this available as a two-dimensional code (data matrix/QR code)</li> <li>• Easily upgradable to new functional status via USB interface</li> </ul>	<ul style="list-style-type: none"> <li>• Diagnostics with menu prompting with 7-segment display</li> </ul>

# SINAMICS G120X infrastructure converters for HVAC/Water/Wastewater

0.75 kW to 630 kW (1 hp to 700 hp)

Supplementary system components > IOP-2 Intelligent Operator Panel

## Overview

### IOP-2 Intelligent Operator Panel



IOP-2 Intelligent Operator Panel

The Intelligent Operator Panel IOP-2 is a very user-friendly and powerful operator panel for the SINAMICS G120, SINAMICS G120C, SINAMICS G120P, SINAMICS G120X, SINAMICS G110D, SINAMICS G120D, SINAMICS G110M and SIMATIC ET 200pro FC-2.

The IOP-2 supports both newcomers and drive experts. Thanks to the membrane keyboard with a central sensor control field, high-contrast color displays, menu-based operation and simple setup processes, which do not require special drive know-how, it is easy to commission drives. The updated IOP-2 (from V2.3) offers a new concept, which allows faster and easier commissioning of the drive.

The Quick Startup provides with an overview of the basic parameters required to commission and operate the drive in a few minutes.

Advanced Startup supports easier commissioning of more complex applications and provides the parameters on one screen, thus eliminating the need to switch between different areas within the IOP-2.

Advanced Setup provides with a list of categories that needs to be checked and that guides the user by highlighting the status icons of categories, which have been altered by the user. Furthermore, a drive can be essentially commissioned without having to use a printed parameter list – as the parameters are displayed in plain text, and explanatory help texts and the parameter filtering functions are provided.

The status screen allows the graphical visualization of two process values and the numerical visualization of four process values. Process values can also be displayed in technological units.

The IOP-2 supports standard commissioning of identical drives. For this purpose, a parameter list can be copied from a converter into the IOP-2 and downloaded into other drive units of the same type as required.

The IOP-2 can also use a text editor to create a user-defined parameter list and download it directly to the frequency converter using the IOP-2 download process.

The IOP-2 can be installed in control cabinet doors using the optionally available door mounting kit.

### Updating the IOP-2

The IOP-2 can be updated and expanded using the integrated USB interface.

Data to support future drive systems can be transferred from the PC to the IOP-2. Further, the USB interface allows user languages and simple setup processes that will become available in the future to be subsequently downloaded and the firmware to be updated for the IOP-2<sup>1)</sup>.

The IOP-2 is supplied with power via the USB interface during an update.

### IOP-2 Handheld



IOP-2 Handheld

A handheld version of the IOP-2 can be ordered for mobile use. In addition to the IOP-2, it includes a housing with rechargeable batteries, a charging unit, an RS232 connecting cable, and a USB cable. The charging unit is supplied with connector adapters for Europe, the US and UK. When the batteries are fully charged, the operating time is up to 10 hours.

To connect the IOP-2 Handheld to SINAMICS G110D, SINAMICS G120D, SINAMICS G110M and SIMATIC ET 200pro FC-2, the RS232 connecting cable with optical interface is required in addition.

<sup>1)</sup> Information on updates for the IOP-2 is available at <https://support.industry.siemens.com/cs/document/67273266>

# SINAMICS G120X infrastructure converters for HVAC/Water/Wastewater

0.75 kW to 630 kW (1 hp to 700 hp)

## Supplementary system components > IOP-2 Intelligent Operator Panel

### Selection and ordering data

Description	Article No.
<b>IOP-2 Intelligent Operator Panel</b> For use with SINAMICS G120 SINAMICS G120C SINAMICS G120P SINAMICS G120X SINAMICS G110D SINAMICS G120D SINAMICS G110M SIMATIC ET 200pro FC-2 Operating languages: English, German, French, Italian, Spanish, Portuguese, Dutch, Swedish, Finnish, Russian, Czech, Polish, Turkish, Chinese Simplified	<b>6SL3255-0AA00-4JA2</b>
<b>IOP-2 Handheld</b> For use with SINAMICS G120 SINAMICS G120C SINAMICS G120P SINAMICS G120X SINAMICS G110D SINAMICS G120D SINAMICS G110M SIMATIC ET 200pro FC-2 Included in the scope of delivery: <ul style="list-style-type: none"> <li>• IOP-2</li> <li>• Handheld housing</li> <li>• Rechargeable batteries (4 x AA)</li> <li>• Charging unit (international)</li> <li>• RS232 connecting cable <sup>1)</sup> 3 m (9.84 ft) long, can be used in combination with SINAMICS G120 SINAMICS G120C SINAMICS G120P SINAMICS G120X</li> <li>• USB cable 1 m (3.28 ft) long</li> </ul>	<b>6SL3255-0AA00-4HA1</b>
<b>Accessories</b>	
<b>Door mounting kit</b> For mounting an operator panel in control cabinet doors with sheet steel thicknesses of 1 ... 3 mm (0.04 in ... 0.12 in) Degree of protection IP55 Included in the scope of delivery: <ul style="list-style-type: none"> <li>• Seal</li> <li>• Mounting material</li> <li>• Connecting cable 5 m (16.4 ft) long, also supplies voltage to the IOP-2 directly via the converter</li> </ul>	<b>6SL3256-0AP00-0JA0</b>
<b>RS232 connecting cable</b> 2.5 m (8.20 ft) long, with optical interface for connecting the IOP-2 Handheld to SINAMICS G110D SINAMICS G120D SINAMICS G110M SIMATIC ET 200pro FC-2	<b>3RK1922-2BP00</b>

### Benefits

- New device design
  - Intuitive user interface – membrane keyboard with central sensor control field
  - High-contrast color display with a range of display options
  - IOP-2 device design open for future functional expansions (e.g. device functions, commissioning setups, languages)
  - Easily upgradable to new functional status via USB interface
- Commissioning
  - Simple commissioning via Quick Startup and Advanced Startup
  - Quick Startup allows easy and fast access to all basic parameters required for the commissioning of simple applications
  - Advanced Startup provides the parameters necessary for the commissioning of more complex applications and eliminates the need to switch between different areas of the IOP-2
  - I/O Setup supports quick and easy configuration of the digital and analog inputs and outputs
  - Fieldbus Setup allows easy configuration of the Ethernet/IP and PROFINET interface protocols
  - Fast standard commissioning of converters thanks to the cloning function
  - For quicker access, the parameter data set names can be directly entered respectively changed on the IOP-2 using the virtual keyboard. Extended help functions support the user during commissioning.
  - Simple local commissioning on-site using the handheld version
- Operator control and monitoring
  - Simple, individual local drive control (start/stop, setpoint value specification, change in direction of rotation)
  - Application-specific scenarios such as operator concepts with additional external operating elements can be implemented easily
  - Simple cloning of specific settings of the IOP-2 user interface, such as status screen, language settings, lighting duration, date/time settings, parameter backup mode and "My Parameters" – settings made once can such be easily transferred to many further IOP-2 Intelligent Operator Panels
  - Easy creation of a user-defined parameter list and direct download to the frequency converter using the IOP-2 download process
- Diagnostics
  - Rapid diagnostics thanks to on-site plain text display
  - Integrated plain text help function for local display and resolution of fault messages
- Support function
  - Used to determine the drive data for the Power Module, Control Unit and IOP-2 (article number, serial number, firmware version, error statuses) and makes this available as a two-dimensional code (data matrix/QR code)
  - Allows easy contact with Customer Support via a data matrix/QR code generated on the IOP-2
  - Quick access via mobile devices (e.g. smartphones, tablets) to product information, documentation, FAQs, contact persons via a two-dimensional code generated on the IOP-2 (data matrix/QR code)
  - Scanning and evaluating of the two-dimensional data matrix code using the Industry Online Support app (<https://support.industry.siemens.com/cs/www/en/sc/2067>), see also: <https://support.industry.siemens.com/cs/document/109748340>

<sup>1)</sup> For use in conjunction with SINAMICS G110D, SINAMICS G120D, SINAMICS G110M and SIMATIC ET 200pro FC-2, the RS232 connecting cable with optical interface is required (Article No.: **3RK1922-2BP00**). The cable must be ordered separately.

# SINAMICS G120X infrastructure converters for HVAC/Water/Wastewater

0.75 kW to 630 kW (1 hp to 700 hp)

Supplementary system components > IOP-2 Intelligent Operator Panel

## Integration

### Using the IOP-2 with the converters

	<ul style="list-style-type: none"> <li>SINAMICS G120 with CU230P-2, CU240E-2 or CU250S-2</li> <li>SINAMICS G120C</li> <li>SINAMICS G120P with CU230P-2</li> <li>SINAMICS G120X</li> </ul>	<ul style="list-style-type: none"> <li>SINAMICS G110D</li> <li>SINAMICS G120D</li> <li>SINAMICS G110M</li> <li>SIMATIC ET 200pro FC-2</li> </ul>
<b>Plugging the IOP-2 onto the converter</b> (Voltage supply via converter)	✓	–
<b>Door mounting of the IOP-2 with the door mounting kit</b> (Voltage supply via converter. For this purpose, the IOP-2 must be connected up by means of the connecting cable supplied with the door mounting kit.)	✓	–
<b>Mobile use of the IOP-2 Handheld</b> (supplied from rechargeable batteries)	✓	✓ (RS232 connecting cable with optical interface required, article number 3RK1922-2BP00)

### Door mounting

Using the optionally available door mounting kit, an operator panel can be simply mounted in a control cabinet door with just a few manual operations. In the case of door mounting, the IOP-2 Operator Panel achieves degree of protection IP55/UL Type 12 enclosure.

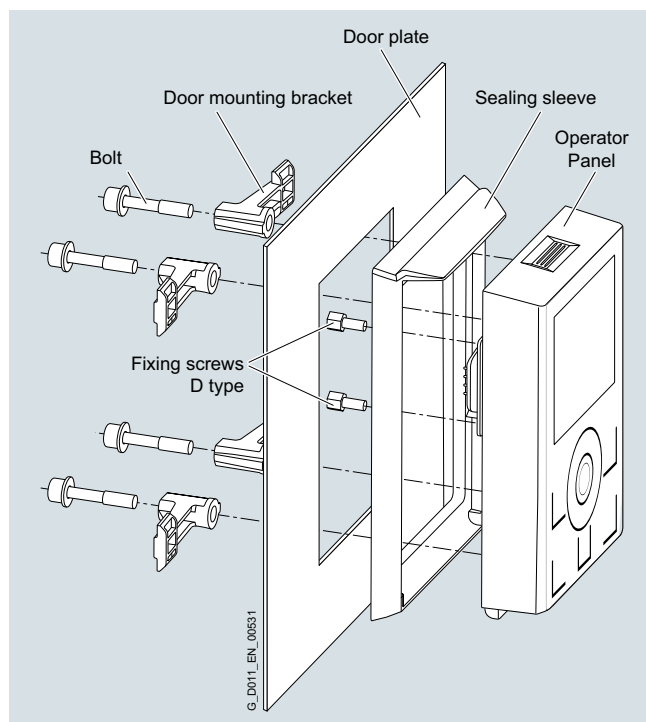

Door mounting kit with plugged-on IOP-2

## Technical specifications

	IOP-2 6SL3255-0AA00-4JA2	IOP-2 Handheld 6SL3255-0AA00-4HA1
<b>Display</b>	High-contrast color display, a variety of display options	
• Resolution	320 × 240 pixels	
<b>Operator panel</b>	Membrane keyboard with central sensor control field	
<b>Operating languages</b>	English, German, French, Italian, Spanish, Portuguese, Dutch, Swedish, Finnish, Russian, Czech, Polish, Turkish, Chinese Simplified	
<b>Ambient temperature</b>		
• During transport and storage	-40 ... +70 °C (-40 ... +158 °F)	-20 ... +55 °C (-4 ... +131 °F)
• During operation	For direct mounting on the converter: 0 ... 50 °C (32 ... 122 °F) For installation with door mounting kit: 0 ... 55 °C (32 ... 131 °F)	0 ... 40 °C (32 ... 104 °F)
<b>Humidity</b>	Relative humidity < 95 %, non-condensing	
<b>Degree of protection</b>	For direct mounting on the converter: IP20  For installation with door mounting kit: IP55, UL Type 12 enclosure	IP20
<b>Dimensions (H × W × D)</b>	106.86 × 70 × 19.65 mm (4.21 × 2.76 × 0.77 in)	195.04 × 70 × 37.58 mm (7.68 × 2.76 × 1.48 in)
<b>Weight, approx.</b>	0.134 kg (0.3 lb)	0.724 kg (1.6 lb)
<b>Compliance with standards</b>	CE, RCM, cULus, EAC, KC-REM-S49-SINAMICS	
<b>Environmental class in operation</b>		
• Harmful chemical substances	Class 3C3 acc. to IEC 60721-3-3: 2002	

## SINAMICS G120X infrastructure converters for HVAC/Water/Wastewater

0.75 kW to 630 kW (1 hp to 700 hp)

### Supplementary system components > BOP-2 Basic Operator Panel

#### Overview



BOP-2 Basic Operator Panel

The BOP-2 Basic Operator Panel can be used to commission drives, monitor drives in operation and input individual parameter settings.

Commissioning of standard drives is easy with the menu-prompted dialog on a 2-line display. Simultaneous display of the parameter and parameter value, as well as parameter filtering, means that basic commissioning of a drive can be performed easily and, in most cases, without a printed parameter list.

The drives are easily controlled manually using directly assigned navigation buttons. The BOP-2 has a dedicated switchover button to switch from automatic to manual mode.

Diagnostics can easily be performed on the connected converter by following the menus.

Up to two process values can be numerically visualized simultaneously.

BOP-2 supports standard commissioning of identical drives. For this purpose, a parameter list can be copied from a converter into the BOP-2 and when required, downloaded into other drive units of the same type.

The operating temperature of the BOP-2 is 0 °C ... 50 °C (32 °F ... 122 °F).

The environmental class/harmful chemical substances of BOP-2 is class 3C3 acc. to IEC 60721-3-3: 2002.

#### Selection and ordering data

Description	Article No.
<b>BOP-2 Basic Operator Panel</b>	<b>6SL3255-0AA00-4CA1</b>
<b>Accessories</b>	
<b>Door mounting kit</b>	<b>6SL3256-0AP00-0JA0</b>
For mounting an operator panel in control cabinet doors with sheet steel thicknesses of 1 ... 3 mm (0.04 ... 0.12 in) Degree of protection IP55 Included in the scope of delivery:	
<ul style="list-style-type: none"> <li>• Seal</li> <li>• Mounting material</li> <li>• Connecting cable 5 m/16.4 ft long, also supplies voltage to the operator panel directly via the converter</li> </ul>	

#### Benefits

- Shorten commissioning times – Easy commissioning of standard drives using basic commissioning wizards (setup)
- Minimize standstill times – Fast detection and rectification of faults (Diagnostics)
- Greater transparency in the process – The status display of the BOP-2 makes process variable monitoring easy (Monitoring)
- Direct mounting on the converter
- User-friendly user interface:
  - Easy navigation using clear menu structure and clearly assigned control keys
  - Two-line display



# SINAMICS G120X infrastructure converters for HVAC/Water/Wastewater

0.75 kW to 630 kW (1 hp to 700 hp)

## Supplementary system components > Memory cards

### Overview



SINAMICS SD memory card

The parameter settings for a converter can be stored on the SINAMICS SD memory card. When service is required, e.g. after the converter has been replaced and the data have been downloaded from the memory card, the drive system is immediately ready for use again.

- Parameter settings can be written from the memory card to the converter or saved from the converter to the memory card.
- Up to 100 parameter sets can be stored.
- The memory card supports standard commissioning without the use of an operator panel such as the IOP-2 or BOP-2.
- If firmware is stored on the memory card, the firmware can be upgraded/downgraded during power-up.

Note:

The memory card is not required for operation and does not have to remain inserted.

### Selection and ordering data

Description	Article No.
<b>SINAMICS SD card</b> 512 MB, empty	<b>6SL3054-4AG00-2AA0</b>

## SINAMICS G120X infrastructure converters for HVAC/Water/Wastewater

0.75 kW to 630 kW (1 hp to 700 hp)

Supplementary system components > SINAMICS G120 Smart Access

### Overview



SINAMICS G120 Smart Access

It is also easy and convenient to commission and operate the SINAMICS G115D, SINAMICS G120, SINAMICS G120C and SINAMICS G120X converters of firmware V4.7 SP6 and higher using the web server module SINAMICS G120 Smart Access and a connected smartphone, tablet or laptop.

### Benefits

- Wireless commissioning, operation and diagnostics via mobile device or laptop thanks to the optional SINAMICS G120 Smart Access
- Easy access to the converter in difficult-to-access areas
- Intuitive user interface and commissioning wizard
- Free choice of terminal devices as the web server works with all common web browsers, such as iOS, Android, Windows, Linux and Mac OS

### Function

- Commissioning using commissioning wizard
- Setting and saving parameters
- Testing motor in JOG mode
- Monitoring of converter data
- Quick diagnostics
- Saving the settings and restoring to factory settings

### Selection and ordering data

Description	Article No.
<b>SINAMICS G120 Smart Access</b> For wireless commissioning, operation and diagnostics of the following converters using a smartphone, tablet or laptop <ul style="list-style-type: none"> <li>• SINAMICS G115D together with the interface kit for SINAMICS G120 Smart Access</li> <li>• SINAMICS G120C</li> <li>• SINAMICS G120 together with the CU230P-2 and CU240E-2 Control Units (without fail-safe versions)</li> <li>• SINAMICS G120X</li> </ul>	<b>6SL3255-0AA00-5AA0</b>

### Technical specifications

	<b>SINAMICS G120 Smart Access</b> 6SL3255-0AA00-5AA0
<b>Operating system</b>	iOS, Android, Windows, Linux, Mac OS
<b>Languages</b>	Support of six languages: English, French, German, Italian, Spanish, Chinese
<b>Ambient temperature</b>	
• During storage and transport	-40 ... +70 °C (-40 ... +158 °F)
• During operation	0 ... 50 °C (32 ... 122 °F) if the Smart Access is plugged directly into the converter
<b>Humidity</b>	< 95 %, non-condensing
<b>Degree of protection</b>	Depending on the degree of protection of the converter, max. IP55/UL Type 12 enclosure
<b>Dimensions</b>	
• Width	70 mm (2.76 in)
• Height	108.9 mm (4.29 in)
• Depth	17.3 mm (0.68 in)
<b>Weight, approx.</b>	0.08 kg (0.18 lb)
<b>Compliance with standards</b>	CE, FCC, SRRG, WPC, ANATEL, BTK

### Integration



SINAMICS G120X frame size FSD with plugged-on SINAMICS G120 Smart Access

The optional SINAMICS G120 Smart Access is simply plugged onto the converter and is available for the following converters of firmware V4.7 SP6 and higher.

- SINAMICS G115D together with the interface kit for SINAMICS G120 Smart Access
- SINAMICS G120C
- SINAMICS G120 together with the CU230P-2 and CU240E-2 Control Units (without fail-safe versions)
- SINAMICS G120X

# SINAMICS G120X infrastructure converters for HVAC/Water/Wastewater

0.75 kW to 630 kW (1 hp to 700 hp)

## Supplementary system components > SINAMICS CONNECT 300 IoT Gateway

### Overview

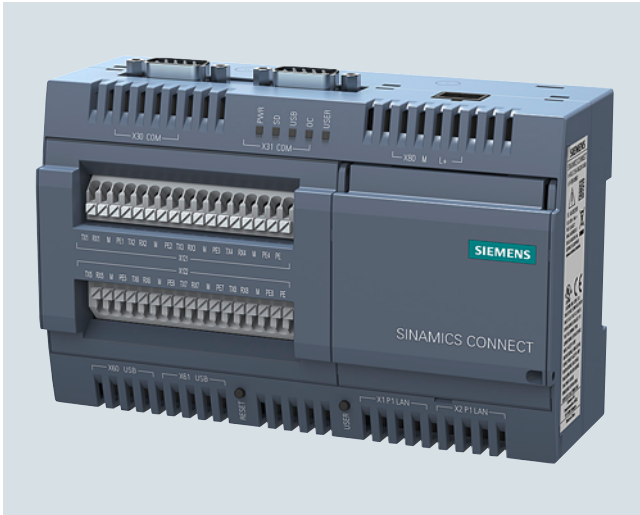

SINAMICS CONNECT 300 IoT Gateway

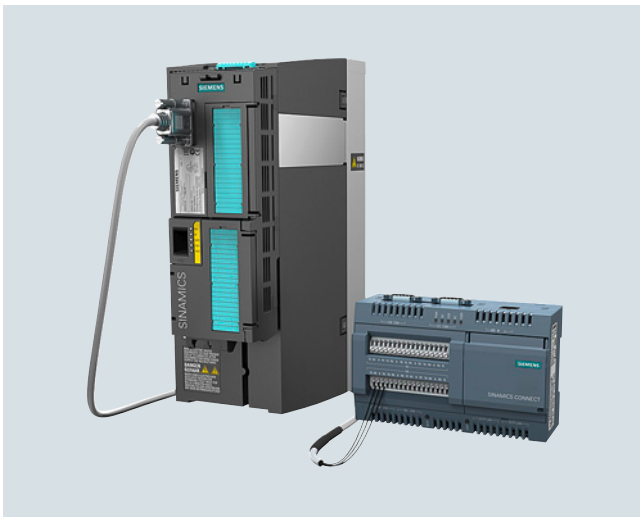

Example: SINAMICS G120 with connected SINAMICS CONNECT 300 IoT Gateway



Example: SINAMICS G120X with connected SINAMICS CONNECT 300 IoT Gateway

The optional SINAMICS CONNECT 300 IoT Gateway is suitable for SINAMICS V20, SINAMICS G120C, SINAMICS G120, SINAMICS G120X, MICROMASTER 420, MICROMASTER 430 and MICROMASTER 440 converters.

The converter system is thus fit for digitalization. Thanks to its full integration in the SINAMICS CONNECT 300 system, data from up to eight converters can be acquired and transferred to the MindSphere cloud solution. The MindSphere application "Analyze MyDrives" facilitates the evaluation of data – tailored to individual customer needs. This simplifies the acquisition and evaluation of converter conditions.

#### Scope of delivery:

- One SINAMICS CONNECT 300 IoT Gateway device with one mounted DC terminal block for connecting to 9 V DC to 36 V DC power supply
- Quick Installation Guide in English language

For more technical information see

<https://support.industry.siemens.com/cs/us/en/ps/25436>

### Benefits

- The integrated web server with its setup wizard ensures a simple and easy commissioning of the device.
- The standard MindSphere tools assure a smooth integration of the drives into the MindSphere world.
- Eight RS232 ports to connect 8 different drives simultaneously
- Up to 40 drive parameters can be transferred to MindSphere at the same time. The dedicated parameters can be selected via a search functionality.
- Point-to-point connection via RS232 prevents that additional load is put to the drive controller and to the fieldbus communication.
- Continuous display of the actual MindSphere connectivity state in the web server
- Comprehensive connection to MindSphere on AWS, MindSphere on AZURE and MindSphere on ALIBABA Cloud
- 500 MByte data buffer secures the data from loss if the internet connection is interrupted.
- Comprehensive service management of the device via the integrated web server (CA certificates, license management, firmware updates, automatic validation of the configuration, etc.)
- Easy top hat rail mounting
- Perfect system harmonization with Analyze My Drives MindSphere App
- Secure communication to MindSphere by using https-tunnelling

### Selection and ordering data

Description	Article No.
<b>SINAMICS CONNECT 300 IoT Gateway</b>	<b>NEW 6SL3255-0AG30-0AA0</b>
for connecting the following converters to the MindSphere cloud:	
<ul style="list-style-type: none"> <li>• SINAMICS V20</li> <li>• SINAMICS G120C</li> <li>• SINAMICS G120</li> <li>• SINAMICS G120X</li> <li>• MICROMASTER 420 / MICROMASTER 430 / MICROMASTER 440</li> </ul>	

## SINAMICS G120X infrastructure converters for HVAC/Water/Wastewater

0.75 kW to 630 kW (1 hp to 700 hp)

### Supplementary system components > SINAMICS G120X I/O Extension Module

#### Overview



SINAMICS G120X I/O Extension Module

The SINAMICS G120X I/O Extension Module increases the number of I/O terminals of the converter and therefore allows for additional converter control functionalities. It also allows for the connection to an operator panel or the SINAMICS G120 Smart Access.

The optional SINAMICS G120X I/O Extension Module has 2 DI, 2 AO, 4 DO (relay), and up to 2 Pt1000/Ni1000 temperature sensors can be directly connected.

#### Notes:

The SINAMICS G120X I/O Extension Module is only supported for SINAMICS G120X converters with FS codes  $\geq$  02 02 (FSA to FSG) / 02 (FSH and FSJ) and firmware  $\geq$  V1.01.

The FS code can be found on the rating plate of the converter.

#### Selection and ordering data

Description	Article No.
<b>SINAMICS G120X I/O Extension Module</b> <span style="color: red; font-weight: bold;">NEW</span> for the direct connection of Pt1000/Ni1000 temperature sensors	<b>6SL3255-0BE00-0AA0</b>

#### More information

Further information and documentation is available on the internet at:

[www.siemens.com/sinamics-g120x/documentation](http://www.siemens.com/sinamics-g120x/documentation)

#### Technical specifications

Article No.	6SL3255-0BE00-0AA0
<b>Analog inputs</b>	
Number of analog inputs	2
Design of the sensor to detect the ambient temperature connectable	2 analog inputs for connecting temperature sensors Pt1000/Ni1000. One of them can be used as an analog input.
Connectable conductor cross-section at the analog input	0.5 ... 1.5 mm <sup>2</sup>
AWG number as coded connectable conductor cross-section at the analog input	21 ... 16
Input current	0 ... 20 mA
<b>Analog outputs</b>	
Number of analog outputs	2
Analog outputs Type	Non-isolated output
Connectable conductor cross-section at the analog output	0.5 ... 1.5 mm <sup>2</sup>
AWG number as coded connectable conductor cross-section at the analog output	21 ... 16
Output voltage at analog output	0 ... 10 V
Output current at analog output	0 ... 20 mA
<b>Digital inputs</b>	
Number of digital inputs	2
Connectable conductor cross-section at the digital inputs	0.5 ... 1.5 mm <sup>2</sup>
AWG number as coded connectable conductor cross-section at the digital inputs	21 ... 16
Digital inputs Input voltage for signal "0" → "1"	11 V
Digital inputs Input voltage for signal "1" → "0"	5 V
Input voltage at digital input maximum	30 V
<b>Digital outputs</b>	
Number of digital outputs	4
Connectable conductor cross-section at the digital outputs maximum	1.5 mm <sup>2</sup>
AWG number as coded connectable conductor cross section at the digital outputs maximum	16
Output current at digital output	2 A
<b>Mechanical data</b>	
Width	71 mm
Depth	27 mm
Height	117 mm

# SINAMICS G120X infrastructure converters for HVAC/Water/Wastewater

0.75 kW to 630 kW (1 hp to 700 hp)

## Supplementary system components > Push-through mounting frames for frame sizes FSA to FSG

### Overview



SINAMICS G120X frame size FSC with IOP-2 Intelligent Operator Panel and push-through mounting frame

The optional push-through mounting frame is used to install a SINAMICS G120X converter, frame sizes FSA to FSG, in a control cabinet with the heat sink outside the control cabinet. The converter achieves degree of protection IP20/UL Open Type with push-through installation.

For push-through installation of frame sizes FSD to FSG, installation handles are available for insertion without the need for a lifting device.

### Selection and ordering data

Description	Article No.
<b>Push-through mounting frames</b> for SINAMICS G120X	
• Frame size FSA	<b>6SL3261-6GA00-0BA0</b>
• Frame size FSB	<b>6SL3261-6GB00-0BA0</b>
• Frame size FSC	<b>6SL3261-6GC00-0BA0</b>
• Frame size FSD	<b>6SL3261-6GD00-0BA0</b>
• Frame size FSE	<b>6SL3261-6GE00-0BA0</b>
• Frame size FSF	<b>6SL3261-6GF00-0BA0</b>
• Frame size FSG	<b>6SL3261-6GG00-0BA0</b>
<b>Accessories</b>	
<b>Installation handles</b> for SINAMICS G120X frame sizes FSD to FSF	<b>6SL3200-0SM22-0AA0</b>

## Supplementary system components > IP21 top covers for frame sizes FSA to FSG

### Overview



SINAMICS G120X frame size FSC with IOP-2 Intelligent Operator Panel and IP21 top cover

Using the optional IP21 top cover, SINAMICS G120X converters in frame sizes FSA to FSG achieve degree of protection 21. With wall mounting, the IP21 top cover has to be installed above the converter.

### Dimensional drawings

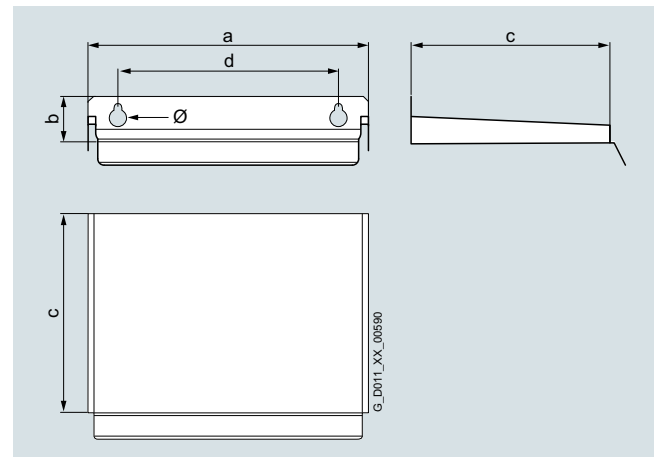

Frame size	Dimensions in mm (inches)			Drilling dimensions in mm (inches)		Cooling clearance between converter and IP21 top cover
	a (width)	b (height)	c (depth)	d	Ø	
FSA	120 (4.72)	25 (0.98)	306 (12.05)	80 (3.15)	4.5 (0.18)	100 (3.94)
FSB	160 (6.3)	25 (0.98)	306 (12.05)	118 (4.65)	5.5 (0.22)	100 (3.94)
FSC	260 (10.24)	29 (1.14)	323 (12.72)	170 (6.69)	6 (0.24)	100 (3.94)
FSD	260 (10.24)	29 (1.14)	323 (12.72)	170 (6.69)	6 (0.24)	300 (11.81)
FSE	335 (13.19)	29 (1.14)	323 (12.72)	230 (9.06)	6 (0.24)	300 (11.81)
FSF, FSG	365 (14.37)	29 (1.14)	443 (17.44)	270 (10.63)	6 (0.24)	300 (11.81)

### Selection and ordering data

Description	Article No.
<b>IP21 top covers</b> for SINAMICS G120X	
• Frame size FSA	<b>6SL3266-1PA00-0BA0</b>
• Frame size FSB	<b>6SL3266-1PB00-0BA0</b>
• Frame sizes FSC and FSD	<b>6SL3266-1PD00-0BA0</b>
• Frame size FSE	<b>6SL3266-1PE00-0BA0</b>
• Frame sizes FSF and FSG	<b>6SL3266-1PF00-0BA0</b>

## SINAMICS G120X infrastructure converters for HVAC/Water/Wastewater

0.75 kW to 630 kW (1 hp to 700 hp)

Supplementary system components > Wiring adapter for frame size FSG

### Overview

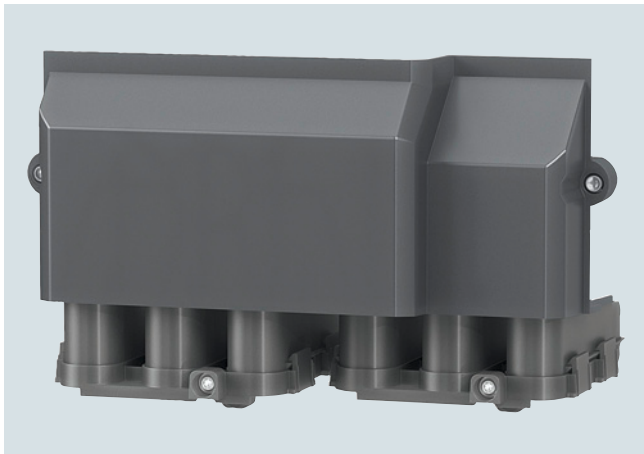

Wiring adapter for frame size FSG

The wiring adapter enables optimal and space-saving wiring of frame size FSG for SINAMICS G120 PM240-2 Power Modules and SINAMICS G120X.

Up to four smaller cables (with a cross section of 120 mm<sup>2</sup> each) can be routed with the adapter for connection to the line supply and to the motor. All cables can be connected on the underside of the adapter, which allows for easy and space-saving wiring.

The scope of delivery of the wiring adapter includes contacts, nuts, a cover and various small components.

### Integration



SINAMICS G120 frame size FSG with wiring adapter (and cable outlet)

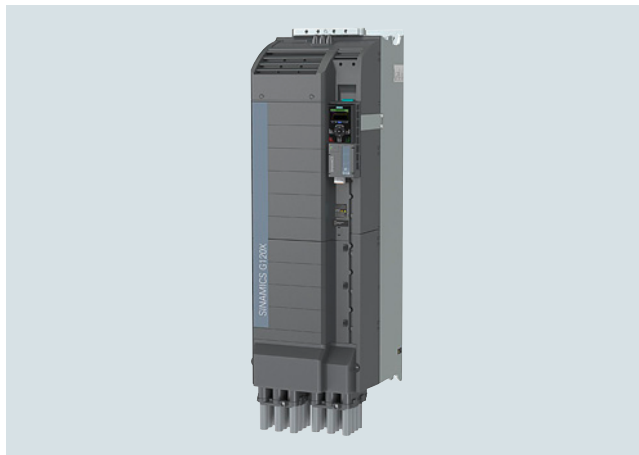

SINAMICS G120X frame size FSG with wiring adapter (and cable outlet)

Further documentation on SINAMICS G120 is available free on the internet at:

[www.siemens.com/sinamics-g120/documentation](http://www.siemens.com/sinamics-g120/documentation)

Further documentation on SINAMICS G120X is available free on the internet at:

[www.siemens.com/sinamics-g120x/documentation](http://www.siemens.com/sinamics-g120x/documentation)

### Selection and ordering data

Description	Article No.
<b>Wiring adapter for frame size FSG</b> <b>NEW</b> for optimal and space-saving wiring of SINAMICS G120 PM240-2 Power Modules and SINAMICS G120X	<b>6SL3266-2HG00-0BA0</b>

## SINAMICS G120X infrastructure converters for HVAC/Water/Wastewater

0.75 kW to 630 kW (1 hp to 700 hp)

Supplementary system components > Installation kit for line-side cable connection, left, for frame size FSH

### Overview

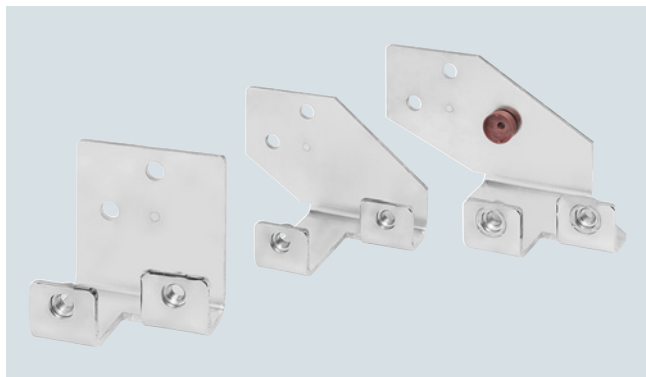

Installation kit for line-side cable connection, left, for SINAMICS G120X, frame size FSH

This installation kit allows supply cables of the SINAMICS G120X converter, frame size FSH, to be connected alternatively on the left-hand side of the converter. The converter can thus be installed higher in the control cabinet, allowing more efficient use of the available cabinet space. In many cases, use of this installation kit also helps in the implementation of effective cabinet cooling.

### Selection and ordering data

Description	Article No.
<b>Installation kit for line-side cable connection, left</b> for SINAMICS G120X frame size FSH	<b>6SL3366-1LH00-0PA0</b>

Spare parts > FPI board for frame sizes FSH and FSJ

### Overview

The FPI board (freely-programmable interface board) is available as a spare part for the SINAMICS G120X converter, frame sizes FSH and FSJ. This is an interface board between Control Unit and Power Module with additional customer terminals (X9, X41).

### Selection and ordering data

Description	Article No.
<b>FPI board</b> for SINAMICS G120X frame sizes FSH and FSJ	<b>6SL3200-0SP05-0AA0</b>

Spare parts > PSB board for frame sizes FSH and FSJ

### Overview

The PSB board (power supply board) is available as a spare part for the SINAMICS G120X converter, frame sizes FSH and FSJ. This is an internal power supply with  $\pm 24$  V for the electronics and 56 V for a power unit fan.

### Selection and ordering data

Description	Article No.
<b>PSB board</b> for SINAMICS G120X frame sizes FSH and FSJ	<b>6SL3200-0SP06-0AA0</b>

Spare parts > Current transformers for frame sizes FSH and FSJ

### Overview

Current transformers are available as spare parts for the SINAMICS G120X converter, frame sizes FSH and FSJ. These are 2000 A or 1000 A current transformers for measuring the motor current at the device output. The current transformers are used for motor control and converter protection.

### Selection and ordering data

Description	Article No.
<b>Current transformers</b> for SINAMICS G120X	
• 2000 A for frame size FSJ	<b>6SL3200-0SE01-0AA0</b>
• 1000 A for frame sizes FSH and FSJ	<b>6SL3200-0SE02-0AA0</b>

## SINAMICS G120X infrastructure converters for HVAC/Water/Wastewater

0.75 kW to 630 kW (1 hp to 700 hp)

### Spare parts > Spare parts kit for Control Unit

#### Overview

The spare parts kit contains small parts for the SINAMICS G120X Control Unit:

Included in the scope of delivery:

- 1× STO connecting plug for frame sizes FSA to FSC
- 3× replacement doors for the Control Unit
- 4× I/O terminals
- 1× screw for RS485 terminal
- 1× blanking cover
- Label set

#### Selection and ordering data

Description	Article No.
<b>Spare parts kit for Control Unit</b> for SINAMICS G120X	<b>6SL3200-0SK10-0AA0</b>

### Spare parts > Shield connection kit for Control Unit

#### Overview

A shield connection kit for the Control Unit is supplied with the SINAMICS G120X converters, frame sizes FSD to FSG. It is advisable to install the supplied shield connection kit for EMC-compliant configuration of the converter. This shield connection kit can be ordered as a spare part.

The shield connection kit offers optimum shield connection and strain relief for all signal and communication cables.

The kit contains the following:

- a matching shield connection plate
- all of the necessary connecting and retaining elements for mounting

#### Selection and ordering data

Description	Article No.
<b>Shield connection kit for Control Unit</b> for SINAMICS G120X frame sizes FSD to FSG	<b>6SL3264-1EA00-0YA0</b>

### Spare parts > Shield connection kits for Power Module

#### Overview

A shield connection kit is supplied with the SINAMICS G120X converters, frame sizes FSA to FSG. It is advisable to install the supplied shield connection kit for EMC-compliant configuration of the converter. These shield connection kits can be ordered as spare parts.

Please observe the notes included in the operating instructions for the SINAMICS G120X converters, frame sizes FSH and FSJ.

[www.siemens.com/sinamics-g120x/documentation](http://www.siemens.com/sinamics-g120x/documentation)

#### Selection and ordering data

Description	Article No.
<b>Shield connection kits for Power Module</b> for SINAMICS G120X	
• Frame size FSA	<b>6SL3262-1AA01-0DA0</b>
• Frame size FSB	<b>6SL3262-1AB01-0DA0</b>
• Frame size FSC	<b>6SL3262-1AC01-0DA0</b>
• Frame size FSD	<b>6SL3262-1AD01-0DA0</b>
• Frame size FSE	<b>6SL3262-1AE01-0DA0</b>
• Frame size FSF	<b>6SL3262-1AF01-0DA0</b>
• Frame size FSG	<b>6SL3262-1AG01-0DA0</b>

### Spare parts > Small parts assembly set for frame sizes FSD to FSG

#### Overview

A **small parts assembly set** can be ordered for SINAMICS G120 Power Modules PM240-2, SINAMICS G120C and SINAMICS G120X, degree of protection IP20. It contains the following parts:

- Cable entries for frame sizes FSD to FSG
- 2 × 2 pin STO mating connector
- 1 set of warning labels in 30 languages

#### Selection and ordering data

Description	Article No.
<b>Small parts assembly set</b> for SINAMICS G120 Power Modules PM240-2, SINAMICS G120C and SINAMICS G120X degree of protection IP20, frame sizes FSD to FSG	<b>6SL3200-0SK08-0AA0</b>



## SINAMICS G120X infrastructure converters for HVAC/Water/Wastewater

0.75 kW to 630 kW (1 hp to 700 hp)

Spare parts &gt; Terminal cover kits for frame sizes FSD to FSG

### Overview

The terminal cover kit includes a replacement cover for the connecting terminals.

Terminal cover kits, which are suitable for the following converters in frame sizes FSD to FSG, are available:

- SINAMICS G120 PM240-2 Power Modules
- SINAMICS G120 PM250 Power Modules
- SINAMICS G120C
- SINAMICS G120X

### Selection and ordering data

Description	Article No.
<b>Terminal cover kits for SINAMICS G120 PM240-2 Power Modules</b>	
• for frame size FSD	<b>6SL3200-0SM13-0AA0</b>
• for frame size FSE	<b>6SL3200-0SM14-0AA0</b>
• for frame size FSF	<b>6SL3200-0SM15-0AA0</b>
• for frame size FSG	<b>6SL3200-0SM16-0AA0</b>
<b>Terminal cover kits for SINAMICS G120 PM250 Power Modules</b>	
• for frame sizes FSD and FSE	<b>6SL3200-0SM11-0AA0</b>
• for frame size FSF	<b>6SL3200-0SM12-0AA0</b>
<b>Terminal cover kits for SINAMICS G120C</b>	
• for frame size FSD	<b>6SL3200-0SM13-0AA0</b>
• for frame size FSE	<b>6SL3200-0SM14-0AA0</b>
• for frame size FSF	<b>6SL3200-0SM15-0AA0</b>
<b>Terminal cover kits for SINAMICS G120X</b>	
• for frame size FSD	<b>6SL3200-0SM13-0AA0</b>
• for frame size FSE	<b>6SL3200-0SM14-0AA0</b>
• for frame size FSF	<b>6SL3200-0SM15-0AA0</b>
• for frame size FSG	<b>6SL3200-0SM16-0AA0</b>

2

Spare parts &gt; Fan units

### Overview

The fans of the SINAMICS G120X converters are designed for extra long service life. For special requirements, replacement fans are available that can be exchanged quickly and easily.

### Selection and ordering data

Description	Article No.
<b>External fan units for SINAMICS G120X</b>	
• Frame size FSA	<b>6SL3200-0SF52-0AA0</b>
• Frame size FSB	<b>6SL3200-0SF53-0AA0</b>
• Frame size FSC	<b>6SL3200-0SF54-0AA0</b>
• Frame size FSD	<b>6SL3200-0SF15-0AA0</b>
• Frame size FSE	<b>6SL3200-0SF16-0AA0</b>
• Frame size FSF	<b>6SL3200-0SF17-0AA0</b>
• Frame size FSG	<b>6SL3200-0SF18-0AA0</b>
• Frame sizes FSH and FSJ	<b>6SL3300-0SF01-0AA0</b>
<b>Internal fan unit for SINAMICS G120X</b>	
• Frame sizes FSH and FSJ	<b>6SL3200-0SF50-0AA0</b>

Spare parts &gt; Control Units

### Overview

Control units are available as spare parts for the SINAMICS G120X converters frame sizes FSD to FSJ.

### Selection and ordering data

Description	Article No.
<b>Control Units for SINAMICS G120X frame sizes FSD to FSJ</b>	
• USS, Modbus RTU, BACnet MS/TP	<b>6SL3200-0SC10-0BA0</b>
• PROFINET, EtherNet/IP	<b>6SL3200-0SC10-0FA0</b>
• PROFIBUS DP	<b>6SL3200-0SC10-0PA0</b>