

Configuration Manual 12/2006 Edition

**1FK7 Synchronous Motors
SINAMICS S120**

sinamics

SIEMENS

SIEMENS

SINAMICS S120

Synchronous Motors 1FK7

Configuration Manual

Foreword	
Motor Description	1
Application	2
Mechanical data	3
Electrical data	4
Configuration	5
Motor components	6
Technical data and characteristics	7
Dimension drawings	8
Gearbox	9
Appendix	A

Safety Guidelines

This manual contains notices you have to observe in order to ensure your personal safety, as well as to prevent damage to property. The notices referring to your personal safety are highlighted in the manual by a safety alert symbol, notices referring only to property damage have no safety alert symbol. These notices shown below are graded according to the degree of danger.



Danger

indicates that death or severe personal injury **will** result if proper precautions are not taken.



Warning

indicates that death or severe personal injury **may** result if proper precautions are not taken.



Caution

with a safety alert symbol, indicates that minor personal injury can result if proper precautions are not taken.

Caution

without a safety alert symbol, indicates that property damage can result if proper precautions are not taken.

Notice

indicates that an unintended result or situation can occur if the corresponding information is not taken into account.

If more than one degree of danger is present, the warning notice representing the highest degree of danger will be used. A notice warning of injury to persons with a safety alert symbol may also include a warning relating to property damage.

Qualified Personnel

The device/system may only be set up and used in conjunction with this documentation. Commissioning and operation of a device/system may only be performed by **qualified personnel**. Within the context of the safety notes in this documentation qualified persons are defined as persons who are authorized to commission, ground and label devices, systems and circuits in accordance with established safety practices and standards.

Prescribed Usage

Note the following:



Warning

This device may only be used for the applications described in the catalog or the technical description and only in connection with devices or components from other manufacturers which have been approved or recommended by Siemens. Correct, reliable operation of the product requires proper transport, storage, positioning and assembly as well as careful operation and maintenance.

Trademarks

All names identified by ® are registered trademarks of the Siemens AG. The remaining trademarks in this publication may be trademarks whose use by third parties for their own purposes could violate the rights of the owner.

Disclaimer of Liability

We have reviewed the contents of this publication to ensure consistency with the hardware and software described. Since variance cannot be precluded entirely, we cannot guarantee full consistency. However, the information in this publication is reviewed regularly and any necessary corrections are included in subsequent editions.

Foreword

Information on the documentation

You will find an overview of the documentation, which is updated on a monthly basis, in the available languages on the Internet under:

<http://www.siemens.com/motioncontrol>

Select the menu items "Support" → "Technical Documentation" → "Overview of Publications".

The Internet version of DOConCD (DOConWEB) is available at:

<http://www.automation.siemens.com/doconweb>

Information on the range of training courses and FAQs (frequently asked questions) are available on the Internet under:

<http://www.siemens.com/motioncontrol> under menu option "Support"

Target group

Planners and project engineers

Benefits

The Configuration Manual supports you when selecting motors, calculating the drive components, selecting the required accessories as well as when selecting line and motor-side power options.

Standard scope

The scope of the functionality described in this document can differ from the scope of the functionality of the drive system that is actually supplied. Other functions not described in this documentation might be able to be executed in the drive system. This does not, however, represent an obligation to supply such functions with a new control or when servicing. Extensions or changes made by the machine manufacturer are documented by the machine manufacturer.

For the sake of simplicity, this documentation does not contain all detailed information about all types of the product and cannot cover every conceivable case of installation, operation, or maintenance.

Technical Support

If you have any technical questions, please contact our hotline:

	Europe / Africa	Asia / Australia	America
Phone	+49 (0) 180 5050 – 222	+86 1064 719 990	+1 423 262 2522
Fax	+49 (0) 180 5050 – 223	+86 1064 747 474	+1 423 262 2289
Internet	http://www.siemens.com/automation/support-request		
E-mail	mailto:adsupport@siemens.com		

Note

For technical support telephone numbers for different countries, go to:

<http://www.siemens.com/automation/service&support>

Questions about the documentation

If you have any questions (suggestions, corrections) regarding this documentation, please fax or e-mail us at:

Fax	+49 9131 98 63315
E-mail	E-mail to: docu.motioncontrol@siemens.com

A fax form is available in the appendix of this document.

Internet address for SINAMICS

<http://www.siemens.com/sinamics>

EC Declaration of Conformity

The EC Declaration of Conformity for the EMC Directive can be found/obtained in the Internet:

<http://www.support.automation.siemens.com>

under the Product/Order No. 15257461 at the relevant branch office of the A&D MC Division of Siemens AG.

Disposal

Motors must be disposed of carefully taking into account domestic and local regulations in the normal recycling process or by returning to the manufacturer.

The following must be taken into account when disposing of the motor:

- Oil according to the regulations for disposing of old oil
- Not mixed with solvents, cold cleaning agents or remains of paint
- Components that are to be recycled should be separated according to:
 - Electronics waste (e.g. sensor electronics, sensor modules)
 - Iron to be recycled
 - Aluminum
 - Non-ferrous metal (gearwheels, motor windings)

Danger and warning information



Danger

Start-up/commissioning is absolutely prohibited until it has been completely ensured that the machine, in which the components described here are to be installed, is in full compliance with the specifications of Directive 98/37/EC.

Only appropriately qualified personnel may commission/start-up the SINAMICS units and the motors.

This personnel must carefully observe the technical customer documentation associated with this product and be knowledgeable about and carefully observe the danger and warning information.

Operational electrical equipment and motors have parts and components which are at hazardous voltage levels.

When the machine or system is operated, hazardous axis movements can occur.

All of the work carried-out on the electrical machine or system must be carried-out with it in a no-voltage condition.

SINAMICS units are generally designed for operation on low-resistance, grounded power supply networks (TN systems). For additional information please refer to the appropriate documentation for the drive converter systems.



Warning

The successful and safe operation of this equipment and motors is dependent on professional transport, storage, installation and mounting as well as careful operator control, service and maintenance.

For special versions of the drive units and motors, information and data in the catalogs and quotations additionally apply.

In addition to the danger and warning notices in the technical customer documentation supplied, the applicable national, local and plant-specific regulations and requirements must be carefully taken into account.



Caution

The motors can have surface temperatures of over +100 °C.

This is the reason that temperature-sensitive components, e.g. cables or electronic components may neither be in contact nor be attached to the motor.

When connecting-up cables, please observe that they

- are not damaged
 - are not subject to tensile stress
 - cannot be touched by rotating components.
-

Caution

Motors should be connected-up according to the operating instructions provided. They must not be connected directly to the three-phase supply because this will damage them.

SINAMICS drive units with motors are subject, as part of the routine test, to a voltage test in accordance with EN 50178. While the electrical equipment of industrial machines is being subject to a voltage test in accordance with EN60204-1, Section 19.4, all SINAMICS drive unit connections must be disconnected/withdrawn in order to avoid damaging the SINAMICS drive units.

Caution

The DRIVE-CLiQ interface contains motor and encoder-specific data as well as an electronic rating plate. This is the reason that this Sensor Module may only be operated on the original motor - and may not be mounted onto other motors or replaced by a sensor module from other motors.

The DRIVE-CLiQ interface has direct contact to components that can be damaged/destroyed by electrostatic discharge (ESDS). Neither hands nor tools that could be electrostatically charged may come into contact with the connections.

Note

Under field conditions and in dry service areas, SINAMICS units with motors conform to Low-Voltage Directive 73/23/EEC.

In configurations specified in the associated EC Declaration of Conformity, SINAMICS units with motors conform to the EMC Directive 89/336/EEC.

ESDS instructions**Caution**

An **electrostatic-sensitive device** (ESDS) is an individual component, integrated circuit, or module that can be damaged by electrostatic fields or discharges.

ESDS regulations for handling boards and equipment:

When handling components that can be destroyed by electrostatic discharge, it must be ensured that personnel, the workstation and packaging are well grounded!

Personnel in ESD zones with conductive floors may only touch electronic components if they are

- grounded through an ESDS bracelet and
- wearing ESDS shoes or ESDS shoe grounding strips.

Electronic boards may only be touched when absolutely necessary.

Electronic boards may not be brought into contact with plastics and articles of clothing manufactured from man-made fibers.

Electronic boards may only be placed on conductive surfaces (table with ESDS surface, conductive ESDS foam rubber, ESDS packing bag, ESDS transport containers).

Electronic boards may not be brought close to data terminals, monitors or television sets. Minimum clearance to screens > 10 cm).

Measurements may only be carried-out on electronic boards and modules if

- the measuring instrument is grounded (e.g. via a protective conductor) or
 - before making measurements with a potential-free measuring device, the measuring head is briefly discharged (e.g. by touching an unpainted blank piece of metal on the control cabinet).
-

Information regarding non-Siemens products

Notice

This document contains recommendations relating to non-Siemens products. Non-Siemens products whose fundamental suitability is familiar to us. It goes without saying that equivalent products from other manufacturers may be used. Our recommendations are to be seen as helpful information, not as requirements or dictates. We cannot accept any liability for the quality and properties/features of non-Siemens products.

Table of contents

	Foreword	5
1	Motor Description.....	15
1.1	Features	15
1.2	Technical features.....	16
1.3	Selection and Ordering Data.....	18
1.3.1	1FK7 Compact motors	18
1.3.2	1FK7 High Dynamic motors	20
1.3.3	1FK7 Motors on Power Module 1 AC 230 V.....	22
2	Application.....	25
2.1	Environment.....	25
2.1.1	Mounting position.....	25
2.1.2	Influence of the mounting type and mounted components.....	25
2.1.3	Cooling	27
2.1.4	Degree of protection	28
2.1.5	Paint finish.....	29
2.1.6	Operation under vibrational or shock stress conditions.....	30
2.1.7	Cantilever and axial forces.....	30
2.2	Electrical connections	32
2.2.1	Overview of connections	32
2.2.2	Power connection	33
2.2.3	DRIVE-CLiQ.....	33
2.2.4	Rotating the connectors	35
3	Mechanical data	37
4	Electrical data	39
4.1	Torque-speed characteristic	39
4.2	Voltage limiting characteristics.....	40
4.3	Field weakening mode	45
4.4	Definitions	47
5	Configuration	53
5.1	Engineering software	53
5.1.1	SIZER engineering tool.....	53
5.1.2	STARTER drive/commissioning software.....	56
5.1.3	Engineering System Drive ES.....	58
5.2	SINAMICS configuring sequence, suppress title.....	61
5.3	Dimensioning	62
5.3.1	1. Clarification of the type of drive	62
5.3.2	2. Definition of the load event, calculation of max. load torque	63
5.3.3	3. Specification of the motor	68

6	Motor components	69
6.1	Thermal motor protection.....	69
6.2	Encoder (option).....	71
6.2.1	Encoder overview.....	71
6.2.2	Encoder connection for motors with DRIVE-CLiQ.....	72
6.2.3	Encoder connection for motors without DRIVE-CLiQ.....	72
6.2.4	Incremental encoders.....	73
6.2.5	Absolute value encoder.....	75
6.2.6	Resolvers.....	77
6.3	Holding brake (option).....	79
6.3.1	Properties.....	79
6.3.2	Brake types.....	79
6.3.3	Permanent-magnet brake.....	80
6.3.4	Spring-operated brake.....	80
6.3.5	Protective circuitry for the brake.....	81
6.3.6	Technical data of the holding brake.....	83
6.4	Brake resistances (armature short-circuit braking).....	84
6.4.1	Function description.....	84
6.4.2	Rating.....	85
6.4.3	Braking time and deceleration distance.....	85
6.4.4	Dimensioning of braking resistors.....	87
6.5	Drive coupling.....	89
6.5.1	Function description.....	89
6.5.2	Technical data for the couplings.....	90
7	Technical data and characteristics	91
7.1	Introduction.....	91
7.2	1FK7 motors on SINAMICS S120 with 3 AC 400/480 V power supply.....	92
7.2.1	1FK7 Compact.....	92
7.2.2	1FK7 High Dynamic.....	134
7.3	1FK7 motors on SINAMICS S120 Power Module with 1 AC 230 V power supply.....	156
7.4	Cantilever force diagrams.....	172
8	Dimension drawings	177
8.1	1FK7 Compact and High Dynamic motors.....	178
8.1.1	1FK7 Compact motors.....	178
8.1.2	1FK7 High Dynamic motors.....	180
8.2	1FK7-DYA motors with planetary gearbox.....	181
8.3	1FK7 motors with planetary gearbox SP+.....	182
8.4	1FK7 motors with planetary gearbox LP+.....	187
9	Gearbox	191
9.1	Dimensioning the gearbox.....	191
9.1.1	Overview.....	191
9.1.2	Dimensioning for S3 duty for non-ventilated systems.....	191
9.1.3	Dimensioning for S1 duty for non-ventilated systems.....	192
9.1.4	Change to the S1 characteristic when a gearbox is mounted.....	193
9.1.5	Startup procedure.....	193
9.1.6	Motors with mounted gearbox.....	193

	9.2 Motors with planetary gears.....	194
	9.2.1 Characteristics of SP+ series.....	194
	9.2.1.1 Selection and ordering data.....	196
	9.2.2 Characteristics of the LP+ series.....	200
	9.2.2.1 Selection and Ordering Data.....	202
	9.2.3 Compact geared motor 1FK7 DYA.....	203
	9.2.3.1 Mounting options.....	207
	9.3 Motors with helical and bevel gearboxes.....	208
	9.3.1 Characteristics.....	208
	9.3.2 Selection and ordering data.....	211
	9.3.3 Types of construction and mounting positions.....	239
A	Appendix.....	245
	A.1 References.....	245
	Index.....	251

Motor Description

1.1 Features

Overview

1FK7 motors are extremely compact permanent-magnet synchronous motors. The available options, gear units and encoders, together with the expanded product range, mean that the 1FK7 motors can be optimally adapted to any application. They therefore also satisfy the permanently increasing demands of state-of-the-art machine generations.

1FK7 motors can be combined with the SINAMICS S120 drive system to create a powerful system with high functionality. The integrated encoder systems for speed and position control can be selected depending on the application.

The motors are designed for operation without external cooling and the heat is dissipated through the motor surface. 1FK7 motors have a high overload capability.



Figure 1-1 1FK7 motors

Benefits

1FK7 Compact motors offer:

- Space-saving installation thanks to extremely high power/weight ratio
- Can be universally used for many applications
- Wide range of motors

1FK7 High Dynamic motors offer:

- Extremely high dynamic response thanks to low rotor moment of inertia

Fields of application

- Machine tools
- Robots and handling systems
- Wood, glass, ceramics and stone working
- Packaging, plastics and textile machines
- Auxiliary axes

1.2 Technical features

Table 1-1 Technical features

Type of motor	Permanent-magnet synchronous motor
Magnet material	Rare-earth magnetic material
Insulation of the stator winding in accordance with EN 60034-1 (IEC 60034-1)	Temperature class F for a winding temperature of $\Delta T = 100$ K at an ambient temperature of +40 °C
Installation altitude (in accordance with EN 60034-1 and IEC 60034-1)	≤ 1000 m above sea level, otherwise power derating
Type of construction in accordance with EN 60034-7 (IEC 60034-7)	IM B5 (IM V1, IM V3)
Degree of protection in accordance with EN 60034-5 (IEC 60034-5) ²⁾	IP64
Cooling	Non-ventilated
Temperature monitoring	KTY 84 temperature sensor in the stator winding
Drive shaft end in accordance with DIN 748-3 (IEC 60072-1)	Smooth shaft (no keyway)
Paint finish ²⁾	Unpainted
2nd rating plate ²⁾ 3rd rating plate ²⁾	glued into the bearing endshield supplied loose
Radial eccentricity, concentricity, and axial eccentricity in accordance with DIN 42955 (IEC 60072-1)	Tolerance N (normal)
Vibration severity in accordance with EN 60034-14 (IEC 60034-14)	Grade A; vibration severity grade is adhered to up to rated speed.

Max. sound pressure level in accordance with EN ISO 1680	1FK701□: 55 dB(A) 1FK702□: 55 dB(A) 1FK703□: 55 dB(A) 1FK704□: 55 dB(A) 1FK706□: 65 dB(A) 1FK708□: 70 dB(A) 1FK710□: 70 dB (A)
Encoder systems, integrated for motors with/without DRIVE-CLiQ interface	<ul style="list-style-type: none"> • Incremental encoder sin/cos 1 V_{PP} 2048 S/R • Absolute encoder ¹⁾, multiturn, 2048 S/R with 1FK704 to 1FK710. 512 S/R with 1FK701 to 1FK703 and traversing range 4096 R with EnDat interface • Simple absolute encoder ¹⁾, multiturn, 32 S/R and traversing range 4096 R with EnDat interface • Resolver, multipole (number of pole pairs corresponds to number of pole pairs of the motor) • Resolver, 2-pole
Connecting	Connectors for signals and power can be rotated (270°)
Options ²⁾	<ul style="list-style-type: none"> • Drive shaft end with key and keyway (half-key balancing) • Integrated holding brake • Degree of protection IP65, additional IP67 drive end flange • Planetary gearbox (requires: plain shaft end and degree of protection IP65) • Paint finish, anthracite

S/R = Signals/Revolution

1) When an absolute encoder is used, the rated torque is reduced by 10%.

2) 1FK701□: Only available in degree of protection IP54 and with painted finish
Rating plate enclosed separately
No planetary gearbox possible

1.3 Selection and Ordering Data

1.3.1 1FK7 Compact motors

Rated speed	Shaft height	Rated power	Static torque	Rated torque ¹⁾	Rated current	1FK7 synchronous motor Compact natural cooling	Number of pole pairs	Rotor moment of inertia (without brake)	Weight (without brake)
n_{rated}	SH	P_{rated} at $\Delta T=100$ K	M_0 at $\Delta T=100$ K	M_{rated} at $\Delta T=100$ K	I_{rated} at $\Delta T=100$ K	Order No.		J	m
rpm		kW/HP	Nm/lb _f -ft	Nm/lb _f -ft	A			10^{-4} kgm ² /lb _f -in ²	kg/lb
2000	100	7.75/10.4	48/35.4	37/27.3	16	1FK7105-5AC71-1 ■■■	4	156/0.1381	39/86.2
3000	48	0.82/1.1	3/2.2	2.6/1.9	1.95	1FK7042-5AF71-1 ■■■	4	3.01/0.0027	4.9/10.8
	63	1.48/2.0	6/4.4	4.7/3.5	3.7	1FK7060-5AF71-1 ■■■	4	7.95/0.0070	7/15.4
		2.29/3.1	11/8.1	7.3/5.4	5.6	1FK7063-5AF71-1 ■■■	4	15.1/0.0134	11.5/25.4
	80	2.14/2.9	8/5.9	6.8/5	4.4	1FK7080-5AF71-1 ■■■	4	15/0.0133	10/22.1
		3.3/4.4	16/11.8	10.5/7.7	7.4	1FK7083-5AF71-1 ■■■	4	27.3/0.0242	14/30.9
100	3.77/5.1	18/13.3	12/8.8	8	1FK7100-5AF71-1 ■■■	4	55.3/0.0489	19/41.9	
	4.87/6.5	27/19.9	15.5/11.4	11.8	1FK7101-5AF71-1 ■■■	4	79.9/0.0707	21/46.3	
	5.37/7.2 ²⁾	36/26.5	20.5/15.1 ²⁾	16.5 ²⁾	1FK7103-5AF71-1 ■■■	4	105/0.0929	29/63.9	
	8.17/11.0	48/35.4	26/19.2	18	1FK7105-5AF71-1 ■■■	4	156/0.1381	39/86.2	
4500	63	1.74/2.3	6/4.4	3.7/2.7	4.1	1FK7060-5AH71-1 ■■■	4	7.95/0.0070	7/15.4
		2.09/2.8 ³⁾	11/8.1	5/3.7 ³⁾	6.1 ³⁾	1FK7063-5AH71-1 ■■■	4	15.1/0.0134	11.5/25.4
	80	2.39/3.2 ³⁾	8/5.9	5.7/4.2 ³⁾	5.6 ³⁾	1FK7080-5AH71-1 ■■■	4	15/0.0133	10/22.1
		3.04/4.1 ⁴⁾	16/11.8	8.3/6.1 ⁴⁾	9 ⁴⁾	1FK7083-5AH71-1 ■■■	4	27.3/0.0242	14/30.9
6000	20	0.05/0.1	0.18/0.1	0.08/0.1	0.85	1FK7011-5AK71-1 ■■3	4	0.064/0.0001	0.9/2
		0.10/0.1	0.35/0.3	0.16/0.1	0.85	1FK7015-5AK71-1 ■■3	4	0.083/0.0001	1.1/2.4
	28	0.43/0.6	0.85/0.6	0.6/0.4	1.4	1FK7022-5AK71-1 ■■■	3	0.28/0.0002	1.8/4
		36	0.50/0.7	1.1/0.8	0.8/0.6	1.3	1FK7032-5AK71-1 ■■■	3	0.61/0.0005
			0.63/0.8	1.6/1.2	1/0.7	1.3	1FK7034-5AK71-1 ■■■	3	0.9/0.0008
48	0.69/0.9	1.6/1.2	1.1/0.8	1.7	1FK7040-5AK71-1 ■■■	4	1.69/0.0015	3.5/7.7	
	1.02/1.4 ⁵⁾	3/2.2	1.95/1.4 ⁵⁾	3.1 ⁵⁾	1FK7042-5AK71-1 ■■■	4	3.01/0.0027	4.9/10.8	
Encoder systems for motors without DRIVE-CLiQ interface:		Incremental encoder sin/cos 1 V _{pp} 2048 pulses/revolution Abs. encoder EnDat 2048 pulses/rev. ¹⁾ (not for 1FK701 to 1FK703) Abs. encoder EnDat 512 pulses/rev. ¹⁾ (only for 1FK701 to 1FK703) Basic absolute encoder EnDat 32 pulses/revolution ¹⁾ (not for 1FK701 to 1FK703) Multi-pole resolver 2-pole resolver				A E H G S T			
Encoder systems for motors with DRIVE-CLiQ interface ⁸⁾ :		Incr. encoder sin/cos 1 V _{pp} 2048 pulses/rev. (not for 1FK701) Abs. encoder EnDat 2048 pulses/rev. ¹⁾ (not for 1FK701 to 1FK703) Abs. encoder EnDat 512 pulses/rev. ¹⁾ (only for 1FK702/1FK703) Basic absolute encoder EnDat 32 pulses/revolution ¹⁾ (not for 1FK701 to 1FK703) Multi-pole resolver (not for 1FK701) 2-pole resolver (not for 1FK701)				D F L K U P			
Shaft extension:		Radial eccentricity tolerance:		Holding brake:		A B G H			
Fitted key and keyway		N		without		A			
Fitted key and keyway		N		with		B			
Plain shaft		N		without		G			
Plain shaft		N		with		H			
Degree of protection:		IP64 IP65, drive end flange IP67 IP64 (IP54 for 1FK701) and anthracite paint finish IP65, drive end flange IP67, anthracite paint finish				0 2 3 5			

To select the degree of protection and type, see "Selection guide".

Motor type (continued)	Static current I_0 at M_0 $\Delta T=100$ K A	Calculated power $P_{calc} = M_0 \times$ $n_{rated}/9550$ P_{calc} for M_0 $\Delta T=100$ K kW/HP	SINAMICS Motor Module		Power cable with complete shield Motor terminal (and brake terminal) via power connector		
			Rated output current I_{rated} A	Order No. For complete order no., see "SINAMICS S120"	Power con- nector Size	Motor cable cross section ⁷⁾ mm ²	Order no. Pre-assembled cable
1FK7105-5AC71...	20	10/13.4	30	6SL312 ■ - ■TE23-0AA.	1.5	4 x 2.5	6FX ■002-5 ■S31-....
1FK7042-5AF71...	2.2	0.9/1.2	3	6SL312 ■ - ■TE13-0AA.	1	4 x 1.5	6FX ■002-5 ■S01-....
1FK7060-5AF71...	4.5	1.9/2.6	5	6SL312 ■ - ■TE15-0AA.	1	4 x 1.5	6FX ■002-5 ■S01-....
1FK7063-5AF71...	8	3.5/4.7	9	6SL312 ■ - ■TE21-0AA.	1	4 x 1.5	6FX ■002-5 ■S01-....
1FK7080-5AF71...	4.8	2.5/3.4	5	6SL312 ■ - ■TE15-0AA.	1	4 x 1.5	6FX ■002-5 ■S01-....
1FK7083-5AF71...	10.4	5.0/6.7	9 ⁶⁾	6SL312 ■ - ■TE21-0AA.	1	4 x 1.5	6FX ■002-5 ■S01-....
1FK7100-5AF71...	11.2	5.7/7.6	18	6SL312 ■ - ■TE21-8AA.	1	4 x 1.5	6FX ■002-5 ■S01-....
1FK7101-5AF71...	19	8.5/11.4	18 ⁶⁾	6SL312 ■ - ■TE21-8AA.	1.5	4 x 2.5	6FX ■002-5 ■S31-....
1FK7103-5AF71...	27.5	11.3/15.2	30	6SL312 ■ - 1TE23-0AA.	1.5	4 x 4	6FX ■002-5 ■S41-....
1FK7105-5AF71...	31	15/20.1	30 ⁶⁾	6SL312 ■ - 1TE23-0AA.	1.5	4 x 10	6FX ■002-5 ■S61-....
1FK7060-5AH71...	6.2	2.8/3.8	9	6SL312 ■ - ■TE21-0AA.	1	4 x 1.5	6FX ■002-5 ■S01-....
1FK7063-5AH71...	12	5.2/7.0	18	6SL312 ■ - ■TE21-8AA.	1	4 x 1.5	6FX ■002-5 ■S01-....
1FK7080-5AH71...	7.4	3.8/5.1	9	6SL312 ■ - ■TE21-0AA.	1	4 x 1.5	6FX ■002-5 ■S01-....
1FK7083-5AH71...	15	7.5/10.1	18	6SL312 ■ - ■TE21-8AA.	1	4 x 1.5	6FX ■002-5 ■S01-....
1FK7011-5AK71...	1.5	0.11/0.2	3	6SL312 ■ - ■TE13-0AA.	0.5	4 x 1.5	6FX5002-5DA20-....
1FK7015-5AK71...	1.5	0.22/0.3	3	6SL312 ■ - ■TE13-0AA.	0.5	4 x 1.5	6FX5002-5DA20-....
1FK7022-5AK71...	1.8	0.5/0.7	3	6SL312 ■ - ■TE13-0AA.	1	4 x 1.5	6FX ■002-5 ■S01-....
1FK7032-5AK71...	1.7	0.7/0.9	3	6SL312 ■ - ■TE13-0AA.	1	4 x 1.5	6FX ■002-5 ■S01-....
1FK7034-5AK71...	1.9	1/1.3	3	6SL312 ■ - ■TE13-0AA.	1	4 x 1.5	6FX ■002-5 ■S01-....
1FK7040-5AK71...	2.25	1.0/1.3	3	6SL312 ■ - ■TE13-0AA.	1	4 x 1.5	6FX ■002-5 ■S01-....
1FK7042-5AK71...	4.4	1.9/2.6	5	6SL312 ■ - ■TE15-0AA.	1	4 x 1.5	6FX ■002-5 ■S01-....

Cooling: Internal air cooling	0		
External air cooling	1		
Motor Module: Single Motor Module	1		
Double Motor Module	2		
Power cable model: MOTION-CONNECT 800		8	
MOTION-CONNECT 500		5	
Without brake cores			C
With brake cores			D
For length code as well as power and signal cables, see "MOTION-CONNECT cables and connections".		

1) If the absolute encoder is used, M_{rated} is reduced by 10%.

2) These values refer to $n = 2500$ rpm.

3) These values refer to $n = 4000$ rpm.

4) These values refer to $n = 3500$ rpm.

5) These values refer to $n = 5000$ rpm.

6) With the specified Motor Module, the motor cannot be utilized with M_0 at $\Delta T = 100$ K winding temperature rise. If a Motor Module with a higher rating is used, you must check whether the specified power cable can be connected to it.

7) The current carrying capacity of the power cables corresponds to IEC 60204-1 for type of routing C under continuous operation conditions with an ambient air temperature of +40 °C (104 °F), designed for I_0 (100 K), PVC/PUR-insulated cable.

8) Motors in shaft height 20 are not available with a DRIVE-CLiQ interface. The encoder systems are connected via the SMC (Sensor Modul Cabinet-Mounted).

Motor Description

1.3 Selection and Ordering Data

1.3.2 1FK7 High Dynamic motors

Rated speed	Shaft height	Rated power	Static torque	Rated torque ¹⁾	Rated current	1FK7 High Dynamic synchronous motor with natural cooling	Number of pole pairs	Rotor moment of inertia (without brake)	Weight (without brake)
n_{rated}	SH	P_{rated} at $\Delta T=100\text{ K}$	M_0 at $\Delta T=100\text{ K}$	M_{rated} at $\Delta T=100\text{ K}$	I_{rated} at $\Delta T=100\text{ K}$	Order No.		J	m
rpm		kW/HP	Nm/lb _f -ft	Nm/lb _f -ft	A			10 ⁻⁴ kgm ² /lb _f -in-s ²	kg/lb
3000	48	1.1/1.48	4/2.9	3.5/2.6	4	1FK7044-7AF71-1 ■■■	3	1.28/0.0011	7.7/17
	63	1.7/2.28	6.4/4.7	5.4/4	5.3	1FK7061-7AF71-1 ■■■	3	3.4/0.0030	10/22.1
		2.51/3.37	12/8.8	8/5.9	7.5	1FK7064-7AF71-1 ■■■	3	6.5/0.0058	15.5/34.2
	80	3.14/4.21 ²⁾	22/89.9	12/8.8 ²⁾	12.5 ²⁾	1FK7085-7AF71-1 ■■■	4	23/0.0204	23.5/51.8
3.77/5.06 ³⁾		28/20.6	18/13.3 ³⁾	14.5 ³⁾	1FK7086-7AF71-1 ■■■	4	23/0.0204	23.5/51.8	
4500	48	1.23/1.65	3.1/2.3	2.6/1.9	4	1FK7043-7AH71-1 ■■■	3	1/0.0009	6.3/13.9
		1.41/1.89	4/2.9	3/2.2	4.9	1FK7044-7AH71-1 ■■■	3	1.28/0.0011	7.7/17
	63	2.03/2.72	6.4/4.7	4.3/3.2	5.9	1FK7061-7AH71-1 ■■■	3	3.4/0.0030	10/22.1
		2.36/3.16	12/8.8	5/3.7	7	1FK7064-7AH71-1 ■■■	3	6.5/0.0058	15.5/34.2
6000	36	0.57/0.76	1.3/1	0.9/0.7	1.5	1FK7033-7AK71-1 ■■■	3	0.27/0.0002	3.1/6.8
	48	1.26/1.69	3.1/2.3	2/1.5	4.4	1FK7043-7AK71-1 ■■■	3	1/0.0009	6.3/13.9
Encoder systems for motors without DRIVE-CLiQ interface:		Incremental encoder sin/cos 1 V _{pp} 2048 pulses/revolution Absolute encoder EnDat 2048 pulses/revolution ¹⁾ (not for 1FK703) Absolute encoder EnDat 512 pulses/revolution ¹⁾ (only for 1FK703) Basic absolute encoder EnDat 32 pulses/rev. ¹⁾ (not for 1FK703) Multi-pole resolver 2-pole resolver				A E H G S T			
Encoder systems for motors mit DRIVE-CLiQ-Schnittstelle:		Incremental encoder sin/cos 1 V _{pp} 2048 pulses/revolution Absolute encoder EnDat 2048 pulses/rev. ¹⁾ (not for 1FK703) Absolute encoder EnDat 512 pulses/revolution ¹⁾ (only for 1FK703) Basic absolute encoder EnDat 32 pulses/rev. ¹⁾ (not for 1FK703) Multi-pole resolver 2-pole resolver				D F L K U P			
Shaft extension:		Radial eccentricity tolerance:		Holding brake:					
Fitted key and keyway		N		without		A			
Fitted key and keyway		N		with		B			
Plain shaft		N		without		G			
Plain shaft		N		with		H			
Degree of protection:		IP64				0			
		IP65 and IP67 drive end flange				2			
		IP64, anthracite paint finish				3			
		IP65 and drive end flange IP67, anthracite paint finish				5			

To select the degree of protection and type, see "Selection guide".

1.3 Selection and Ordering Data

Rated speed	Shaft height	Rated power	Static torque	Rated torque	Rated current	1FK7 Compact/High Dynamic synchronous motor Natural cooling Connection to SINAMICS 230 V 1 AC	Number of pole pairs	Rotor moment of inertia (without brake)	Weight (without brake)
n_{rated}	SH	P_{rated} at $\Delta T=100$ K	M_0 at $\Delta T=100$ K	M_{rated} at $\Delta T=100$ K	I_{rated} at $\Delta T=100$ K	Order No.		J	m
rpm		kW/HP	Nm/lb _f -ft	Nm/lb _f -ft	A			10 ⁻⁴ kgm ² /lb _f -in ^{-s²}	kg/lb
3000	36	0.31/0.42	1.15/0.8	1.0/0.7	1.6	1FK7032-5AF21-1 ■■■	3	0.61/0.0005	2.7/5.9
		0.38/0.51	1.3/1	1.2/0.9	2	1FK7033-7AF21-1 ■■■	3	0.27/0.0002	3.1/6.8
		0.46/0.62	1.6/1.2	1.45/1.1	1.8	1FK7034-5AF21-1 ■■■	3	0.9/0.0008	3.7/8.2
	48	0.82/1.1	3/2.2	2.6/1.9	3.5	1FK7042-5AF21-1 ■■■	4	3.01/0.0027	4.9/10.8
		0.79/1.06	2.7/2	2.5/1.8	3.8	1FK7043-7AF21-1 ■■■	3	1/0.0009	6.3/13.9
6000	20	0.05/0.1	0.18/0.1	0.08/0.1	0.5	1FK7011-5AK21-1 ■■3	4	0.064/0.0001	0.9/2
		0.1/0.1	0.35/0.3	0.16/0.1	0.5	1FK7015-5AK21-1 ■■3	4	0.083/0.0001	1.1/2.4
	28	0.38/0.51	0.85/0.6	0.6/0.4	1.4	1FK7022-5AK21-1 ■■■	3	0.28/0.0002	1.8/4
Encoder systems for motors without DRIVE-CLiQ interface:			Incremental encoder sin/cos 1 V _{pp} 2048 pulses/revolution Absolute encoder EnDat 2048 pulses/rev. (only for 1FK704) ¹⁾ Absolute encoder EnDat 512 pulses/revolution (not for 1FK704) ¹⁾ Basic absolute encoder EnDat 32 pulses/rev. (only for 1FK704) ¹⁾ Multi-pole resolver 2-pole resolver			A E H G S T			
Encoder systems for motors with DRIVE-CLiQ interface ⁴⁾ :			Incr. encoder sin/cos 1 V _{pp} 2048 pulses/rev. (not for 1FK701) Absolute encoder EnDat 2048 pulses/rev. (only for 1FK704) ¹⁾ Abs. encoder EnDat 512 pulses/rev. (not for 1FK701/1FK704) ¹⁾ Basic absolute encoder EnDat 32 pulses/rev. (only for 1FK704) ¹⁾ Multi-pole resolver (not for 1FK701) 2-pole resolver (not for 1FK701)			D F L K U P			
Shaft extension:		Radial eccentricity tolerance:		Holding brake:					
Fitted key and keyway		N		without		A			
Fitted key and keyway		N		with		B			
Plain shaft		N		without		G			
Plain shaft		N		with		H			
Degree of protection:		IP64, without paint finish				0			
		IP64, anthracite paint finish (IP54 for 1FK701)				3			

To select the degree of protection and type, see "Selection guide".

Motor Description

1.3 Selection and Ordering Data

1.3.3 1FK7 Motors on Power Module 1 AC 230 V

Rated speed	Shaft height	Rated power	Static torque	Rated torque	Rated current	1FK7 Compact/High Dynamic synchronous motor Natural cooling Connection to SINAMICS 230 V 1 AC	Number of pole pairs	Rotor moment of inertia (without brake)	Weight (without brake)
n_{rated}	SH	P_{rated} at $\Delta T=100\text{ K}$	M_0 at $\Delta T=100\text{ K}$	M_{rated} at $\Delta T=100\text{ K}$	I_{rated} at $\Delta T=100\text{ K}$	Order No.		J	m
rpm		kW/HP	Nm/lb _r -ft	Nm/lb _r -ft	A			$10^{-4}\text{ kgm}^2/\text{lb}_r\text{-in-s}^2$	kg/lb
3000	36	0.31/0.42	1.15/0.8	1.0/0.7	1.6	1FK7032-5AF21-1 ■■■	3	0.61/0.0005	2.7/5.9
		0.38/0.51	1.3/1	1.2/0.9	2	1FK7033-7AF21-1 ■■■	3	0.27/0.0002	3.1/6.8
		0.46/0.62	1.6/1.2	1.45/1.1	1.8	1FK7034-5AF21-1 ■■■	3	0.9/0.0008	3.7/8.2
3000	48	0.82/1.1	3/2.2	2.6/1.9	3.5	1FK7042-5AF21-1 ■■■	4	3.01/0.0027	4.9/10.8
		0.79/1.06	2.7/2	2.5/1.8	3.8	1FK7043-7AF21-1 ■■■	3	1/0.0009	6.3/13.9
6000	20	0.05/0.1	0.18/0.1	0.08/0.1	0.5	1FK7011-5AK21-1 ■■3	4	0.064/0.0001	0.9/2
		0.1/0.1	0.35/0.3	0.16/0.1	0.5	1FK7015-5AK21-1 ■■3	4	0.083/0.0001	1.1/2.4
	28	0.38/0.51	0.85/0.6	0.6/0.4	1.4	1FK7022-5AK21-1 ■■■	3	0.28/0.0002	1.8/4
Encoder systems for motors without DRIVE-CLiQ interface:			Incremental encoder sin/cos 1 V _{pp} 2048 pulses/revolution			A			
			Absolute encoder EnDat 2048 pulses/rev. (only for 1FK704) ¹⁾			E			
			Absolute encoder EnDat 512 pulses/revolution (not for 1FK704) ¹⁾			H			
			Basic absolute encoder EnDat 32 pulses/rev. (only for 1FK704) ¹⁾			G			
			Multi-pole resolver			S			
			2-pole resolver			T			
Encoder systems for motors with DRIVE-CLiQ interface ⁴⁾ :			Incrém. encoder sin/cos 1 V _{pp} 2048 pulses/rev. (not for 1FK701)			D			
			Absolute encoder EnDat 2048 pulses/rev. (only for 1FK704) ¹⁾			F			
			Abs. encoder EnDat 512 pulses/rev. (not for 1FK701/1FK704) ¹⁾			L			
			Basic absolute encoder EnDat 32 pulses/rev. (only for 1FK704) ¹⁾			K			
			Multi-pole resolver (not for 1FK701)			U			
			2-pole resolver (not for 1FK701)			P			
Shaft extension:			Radial eccentricity tolerance:		Holding brake:				
Fitted key and keyway			N		without				A
Fitted key and keyway			N		with				B
Plain shaft			N		without				G
Plain shaft			N		with				H
Degree of protection:			IP64, without paint finish						0
			IP64, anthracite paint finish (IP54 for 1FK701)						3

To select the degree of protection and type, see "Selection guide".

Motor type (continued)	Static current I_0 at M_0 $\Delta T=100$ K A	Calculated power $P_{calc} = M_0 \times$ $n_{rated}/9550$ P_{calc} for M_0 $\Delta T=100$ K kW/HP	SINAMICS Power Module		Power cable with complete shield Motor terminal (and brake terminal) via power connector		
			Rated output current I_{rated} at M_0 $\Delta T=100$ K A	Order No. For complete order no., see "SINAMICS S120"	Power con- nector Size	Motor cable cross section ³⁾ mm ²	Order no. Pre-assembled cable
1FK7032-5AF21...	1.7	0.36/0.5	2.3	6SL3210 - 1SB12-3UA0	1	4 x 1.5	6FX ■002-5 ■A01-....
1FK7033-7AF21...	2.2	0.41/0.6	2.3	6SL3210 - 1SB12-3UA0	1	4 x 1.5	6FX ■002-5 ■A01-....
1FK7034-5AF21...	1.9	0.5/0.7	2.3	6SL3210 - 1SB12-3UA0	1	4 x 1.5	6FX ■002-5 ■A01-....
1FK7042-5AF21...	3.9	0.94/1.3	3.9	6SL3210 - 1SB14-0UA0	1	4 x 1.5	6FX ■002-5 ■A01-....
1FK7043-7AF21...	3.9	0.85/1.1	3.9	6SL3210 - 1SB14-0UA0	1	4 x 1.5	6FX ■002-5 ■A01-....
1FK7011-5AK21...	0.85	0.11/0.2	0.9	6SL3210 - 1SB11-0UA0	0.5	4 x 1.5	6FX5002-5ME00-.... ²⁾
1FK7015-5AK21...	0.85	0.22/0.3	0.9	6SL3210 - 1SB11-0UA0	0.5	4 x 1.5	6FX5002-5ME00-.... ²⁾
1FK7022-5AK21...	1.8	0.53/0.7	2.3	6SL3210 - 1SB12-3UA0	1	4 x 1.5	6FX ■002-5 ■A01-....
Cooling: Internal air cooling					0		
Motor Module: Single Motor Module					1		
Power cable model: MOTION-CONNECT 800 MOTION-CONNECT 500						8 5	
Without brake cores							C
With brake cores							D
For length code as well as power and signal cables, see "MOTION-CONNECT cables and connections".						

1) If the absolute encoder is used, M_{rated} is reduced by 10%.

2) This power cable is fitted with a connector with M17 thread at the motor end and brake cores as standard (4 x 1.5 mm² + 2 x 1.5 mm²).

3) The current carrying capacity of the power cable corresponds to IEC 60204-1 for type of routing C under continuous operating conditions with an ambient air temperature of +40 °C (104 °F), designed for I_0 (100 K), PVC/PUR-insulated cable.

4) Motors in shaft height 20 are not available with a DRIVE-CLiQ interface. The encoder systems are connected via the SMC (Sensor Module Cabinet-Mounted).

Application

2.1 Environment

2.1.1 Mounting position

Table 2-1 Types of construction (accdg. to IEC 60034-7)

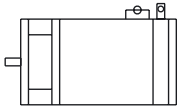
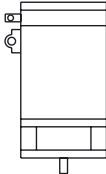
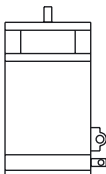
Name	Representation	Description
IM B5		Standard
IM V1		The 1FK7 motors can be used in types of construction IM V1 and IM V3 without special ordering. Note: When configuring the IM V3 type of construction, attention must be paid to the permissible axial forces (weight force of the drive elements) and especially to the necessary degree of protection.
IM V3		

2.1.2 Influence of the mounting type and mounted components

Some of the motor power loss is dissipated through the flange when the motor is connected to the mounting flange.

Non-thermally insulated mounting

The following mounting conditions apply for the specified motor data:

Table 2-2 Non-thermally insulated mounting conditions

Shaft height	Steel plate, width x height x thickness [mm]	Mounting surface[m ²]
1FK701□	120 x 100 x 10	0.012
1FK702□ to 1FK704□	120 x 100 x 40	0.012
1FK706□ to 1FK710□	450 x 370 x 30	0.17

For larger mounting surfaces, the heat dissipation conditions improve.

Thermally insulated mounting without additionally mounted components

For non-ventilated and force-ventilated motors, the motor torque must be reduced by between 5 % and 10 %. We recommend configuring the motor using the M₀(60 K) values.

Thermally insulated mounting with additionally mounted components

- Holding brake (integrated in the motor)
The torque does not have to be additionally reduced
- Gearbox
The torque has to be reduced (refer to Figure "S1 characteristics")

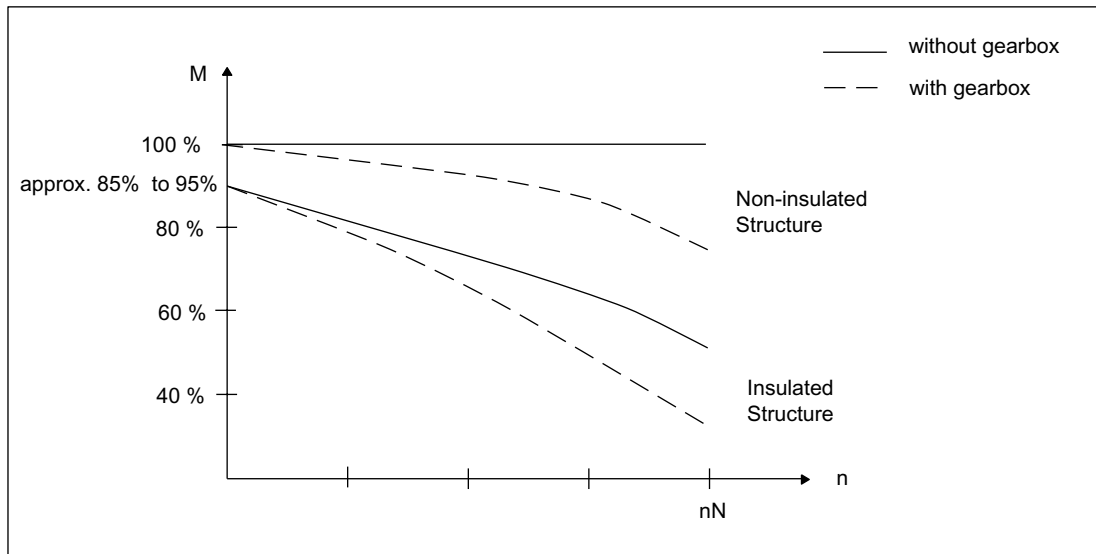

Figure 2-1 S1 characteristics

2.1.3 Cooling

1FK7 motors are self-cooled.

Operating temperature range: -15 °C to +40 °C (without any restrictions).

The power loss is dissipated through radiation and natural convection, which means that adequate heat dissipation must be ensured by suitably mounting the motor.

All of the Catalog data refer to an ambient temperature of 40 °C, mounted so that the motors are not thermally insulated and an installation altitude up to 1000 m above sea level.

If other conditions prevail (ambient temperature > 40 °C or installation altitude > 1000 m above sea level), the permissible torque/power must be defined using the factors from the following table (torque/power reduction according to EN 60034-6).

Ambient temperatures and installation altitudes are rounded-off to 5 °C or 500 m respectively.

Table 2-3 Power derating as a function of the installation altitude and the ambient temperature

Installation altitude above sea level [m]	Ambient temperature in °C					
	< 30	30–40	45	50	55	60
1000	1,07	1,00	0,96	0,92	0,87	0,82
1500	1,04	0,97	0,93	0,89	0,84	0,79
2000	1,00	0,94	0,90	0,86	0,82	0,77
2500	0,96	0,90	0,86	0,83	0,78	0,74
3000	0,92	0,86	0,82	0,79	0,75	0,70
3500	0,88	0,82	0,79	0,75	0,71	0,67
4000	0,82	0,77	0,74	0,71	0,67	0,63



Caution

The surfaces of synchronous motors can have temperatures > 100 °C. When required, protective measures must be provided to prevent coming into contact with the motors.

2.1.4 Degree of protection

The degree of protection designation in accordance with EN 60034-5 and IEC 60034-5 is made using the letters "IP" and two digits (e.g. IP64). The second digit in the degree of protection designation represents the protection against water, the first digit the protection against penetration of foreign matter.

Since most cooling lubricants used in machine tools and transfer machines are oily, creepcapable, and/or corrosive, protection against water alone is insufficient. The servo motors must be protected by suitable covers.

Attention must be paid to providing suitable sealing of the motor shaft for the selected degree of protection for the motor.

Sealing of the motor shaft

Table 2-4 Sealing of the motor shaft

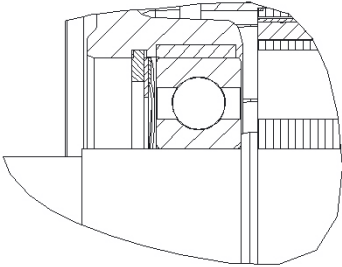
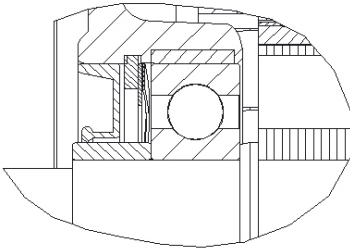
Degree of protection accdg. to EN 60034-5)	Shaft sealing using	Area of application
IP64	Ball bearing 	It is not permissible that there is any moisture in the area around the shaft and the flange. Note: For IP 64 degree of protection it is not permissible that liquid collects in the flange. Shaft outlet is not dust-tight
IP65 (AS flange IP67)	Radial shaft seal DIN 3760 	For gearbox mounting (for gearboxes that are not sealed) to seal against oil. The sealing lip must be adequately cooled and lubricated by the gearbox oil in order to guarantee reliable function. Lifetime 5000 h - 10000 h (nominal value) If a radial shaft sealing ring runs dry, then this has a negative impact on the functionality and the lifetime.

Routing cables in a wet/moist environment

Notice

If the motor is mounted in a humid environment, the power and signal cables must be routed as shown in the following figure.

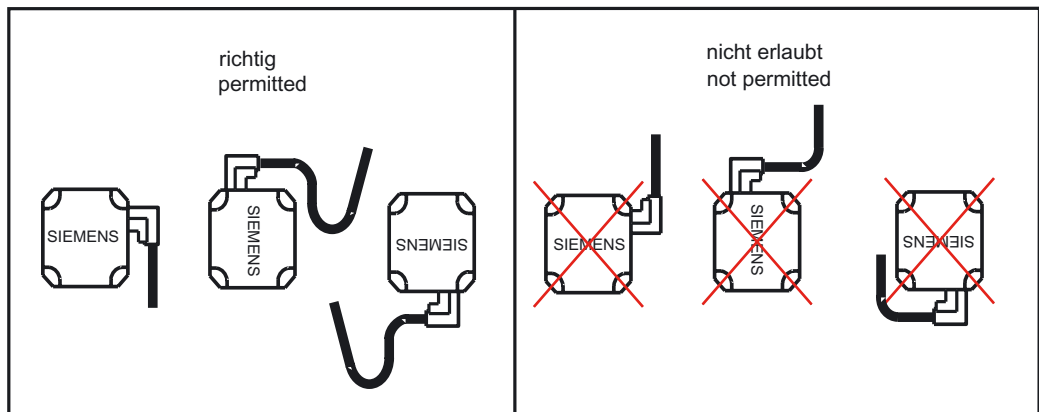

Figure 2-2 Routing cables in a wet/moist environment

2.1.5 Paint finish

1FK7 motors are supplied without a paint finish (1FK701 with paint finish).

Option: with anthracite finish (similar to RAL 7016)

Note

The motors must be ordered with a special paint finish if they are to be used in sub-tropical regions or if they are to be transported by sea. This paint finish prevents the stator lamination from corroding.

2.1.6 Operation under vibrational or shock stress conditions

In order to ensure problem-free operation and a long service life, the vibration values defined in DIN ISO 10816 should not be exceeded.

Table 2-5 Vibration values

Vibrational velocity V_{rms} [mm/s] accdg. to DIN ISO 10816	Frequency f [Hz]	Acceleration a [m/s ²]
4,5	10	0,4
4,5	250	10

Deviating from the specified standard, motors 1FK702□ to 1FK710□ may be operated with higher loads, with the stipulation that the service life will be reduced. In this case, only operation outside the mounted natural frequency is permissible.

Peak acceleration	Axial 20 m/s ²	Radial 50 m/s ²
Shock duration	3 ms	3 ms

2.1.7 Cantilever and axial forces

Cantilever force stressing

Point of application of cantilever forces F_Q at the shaft end

- for average operating speeds
- for a nominal bearing service life (L_{10h}) of 20,000 h

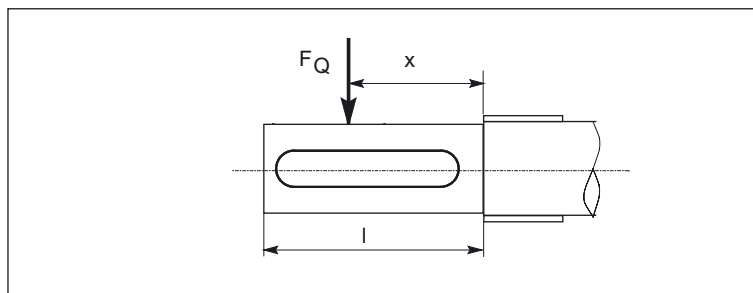

Figure 2-3 Force application point at the drive shaft end

Dimension x : Distance between the point of application of force F_Q and the shaft shoulder in mm.

Dimension l : Length of the shaft end in mm.

For cantilever force diagrams, refer to the section "Technical Data and Characteristics, Cantilever Force Diagrams".

Calculating the belt pre-tension force F_R

$$F_R \text{ [N]} = 2 \cdot M_0 \cdot c / d_R \qquad F_R \leq F_{Qperm}$$

Table 2-6 Explanation of the formula abbreviations

Formula abbreviations	Unit	Description
F_R	N	Belt pre-tension
M_0	Nm	Motor static torque
c	—	Pre-tensioning factor; the pre-tensioning factor is an empirical value from the belt manufacturer. It can be assumed as follows: for toothed belts: $c = 1.5$ to 2.2 for flat belts $c = 2.2$ to 3.0
d_R	m	Effective diameter of the belt pulley

When using other configurations, the actual forces that generated from the torque being transferred must be taken into account.

Axial force stressing



Warning

Motors with integrated holding brake cannot be subject to axial forces!

When using, for example, helical toothed wheels as drive element, in addition to the radial force, there is also an axial force on the motor bearings. For axial forces, the spring-loading of the bearings can be overcome so that the rotor moves corresponding to the axial bearing play present (up to 0.2 mm). A special bearing is required for this. For use of special bearings, contact your Siemens representative.

The permissible axial force can be approximately calculated using the following formula:

$$F_A = 0.35 \cdot F_Q$$

2.2 Electrical connections

2.2.1 Overview of connections

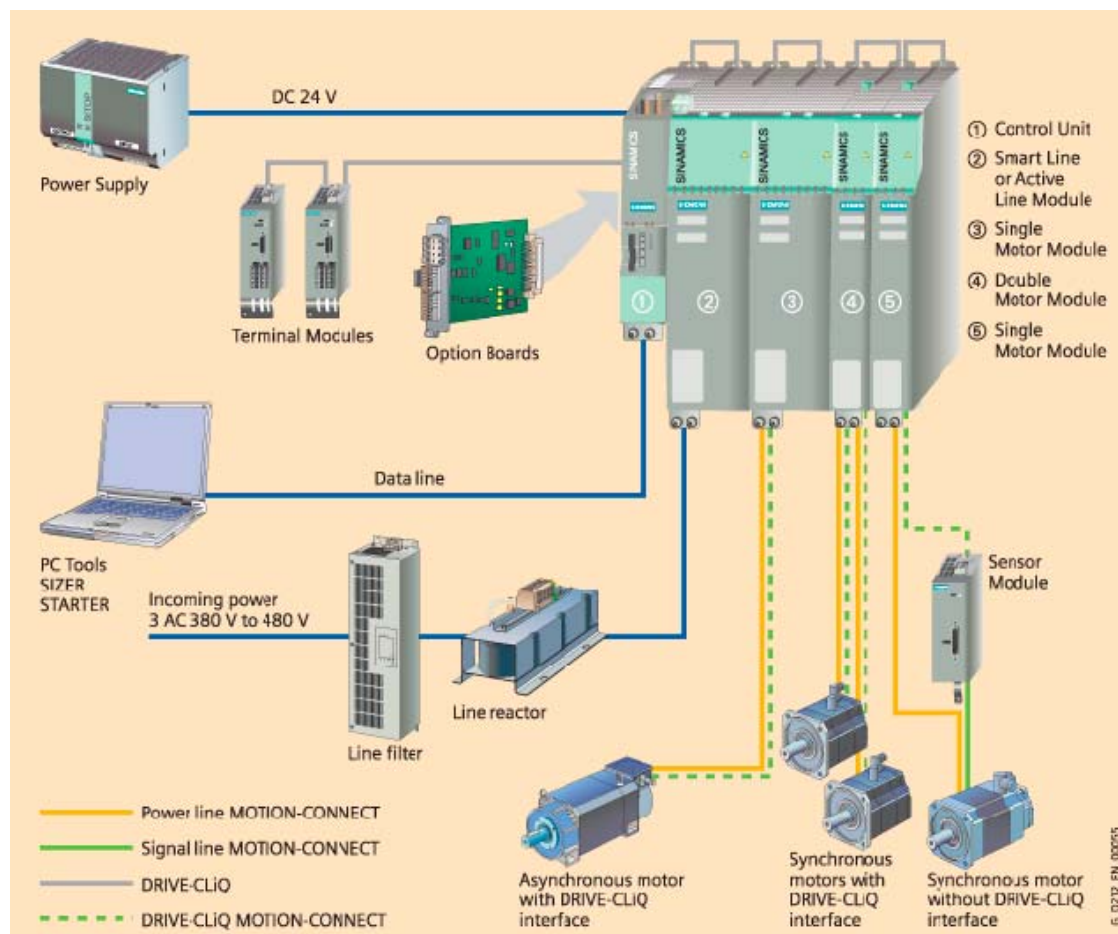

Figure 2-4 SINAMICS S120 system overview

2.2.2 Power connection



Warning

The motors are not designed to be connected directly to the line supply.

Connection assignment, power connector at the motor

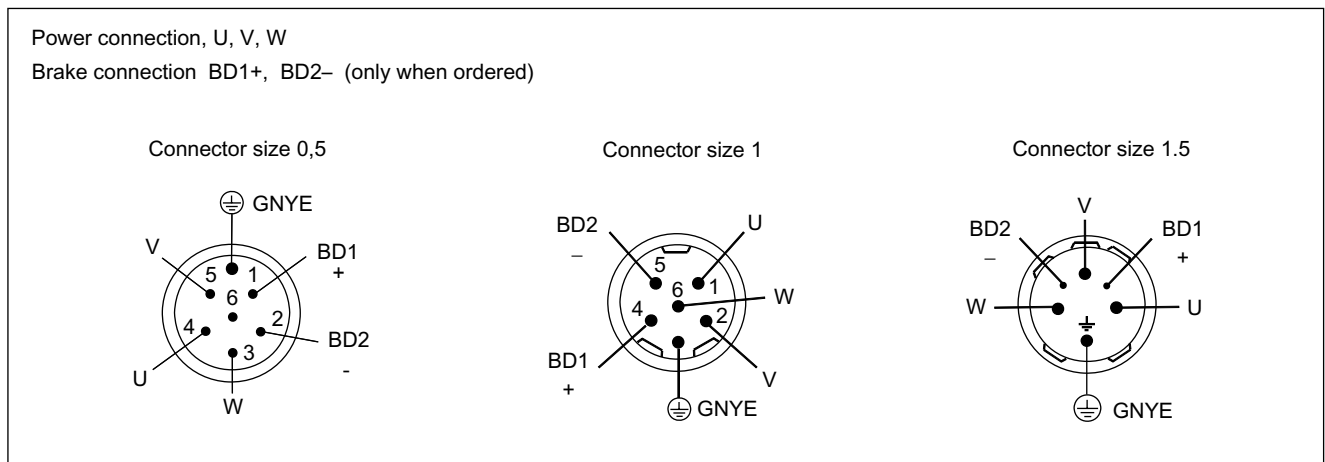

Figure 2-5 Power connection

2.2.3 DRIVE-CLiQ

DRIVE-CLiQ is the preferred method for connecting the encoder systems to SINAMICS.

Motors with a DRIVE-CLiQ interface can be ordered for this purpose. Motors with a DRIVE-CLiQ interface can be directly connected to the associated motor module via the available MOTION-CONNECT DRIVE-CLiQ cables. The MOTION-CONNECT DRIVE-CLiQ cable is connected to the motor in degree of protection IP67. The DRIVE-CLiQ interface supplies power to the motor encoder via the integrated 24 VDC supply and transfers the motor encoder and temperature signals and the electronic type plate data, e.g. a unique identification number, rating data (voltage, current, torque) to the control unit. The MOTION-CONNECT DRIVE-CLiQ cable is used universally for connecting the various encoder types. These motors simplify commissioning and diagnostics, as the motor and encoder type are identified automatically.

Motors with DRIVE-CLiQ

Motors with DRIVE-CLiQ interfaces can be directly connected to the corresponding motor module via the available MOTION-CONNECT DRIVE-CLiQ cables. This means that data are transferred directly to the control unit.

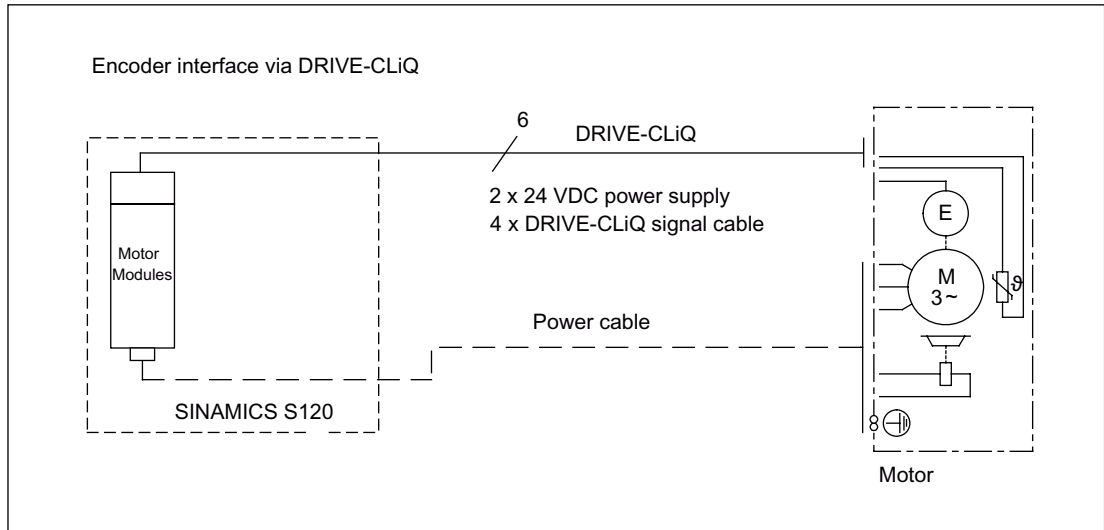

Figure 2-6 Encoder interface with DRIVE-CLiQ

Motors without DRIVE-CLiQ

Motors without DRIVE-CLiQ require a cabinet-mounted sensor module for operation with SINAMICS S120. The sensor modules evaluate the signals from the connected motor encoders or external encoders and convert them to DRIVE-CLiQ. In conjunction with motor encoders, the motor temperature can also be evaluated using sensor modules. For additional information, refer to the SINAMICS Manual.

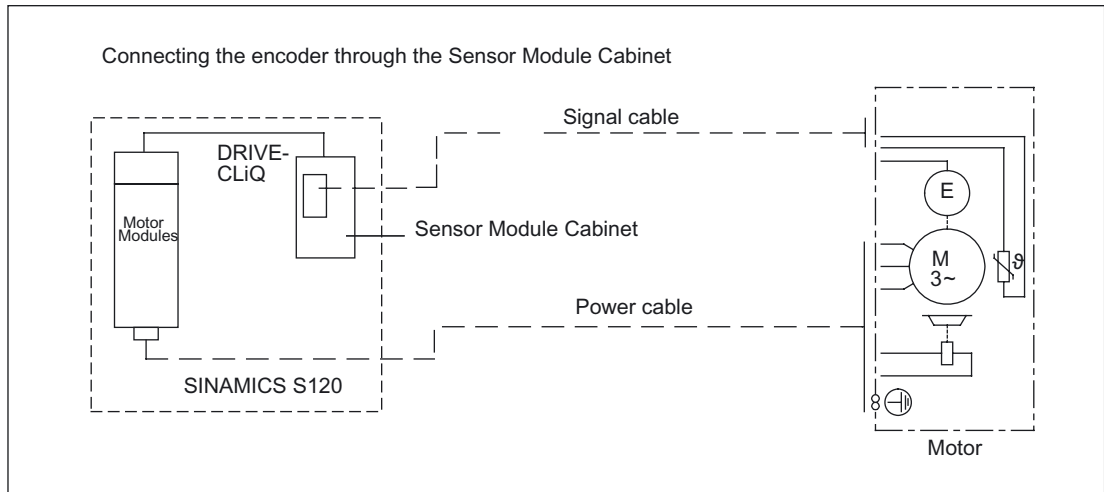

Figure 2-7 Encoder interface without DRIVE-CLiQ

2.2.4 Rotating the connectors

Power connectors, signal connectors, and DRIVE-CLiQ can be rotated to a limited extent.

Notice

The permissible range of rotation may not be exceeded.

In order to guarantee the degree of protection, a max. 10 revolutions are permissible.

Do not exceed max. torque when rotating connectors.

Connectors should be rotated using the mating connector that matches the connector thread.

Connecting cables should be secured against strain and bending.

Motor connectors should be secured so that they cannot be rotated any further.

Connectors may not be subject to continuous force.

Direction and torque when rotating

Table 2-7 Direction and torque when rotating connectors

Connector	Direction of rotation		Max. torque when rotating
	Clockwise	Counter-clockwise	
Power connector, size 0.5	270°	not supported	8 Nm
Power connector, size 1	270°	not supported	8 Nm
Power connector, size 1.5	270°	not supported	15 Nm
Signal connector	90°	180° for SH 20 to 80 90° for SH 100	8 Nm
DRIVE-CLiQ	90°	180°	8 Nm

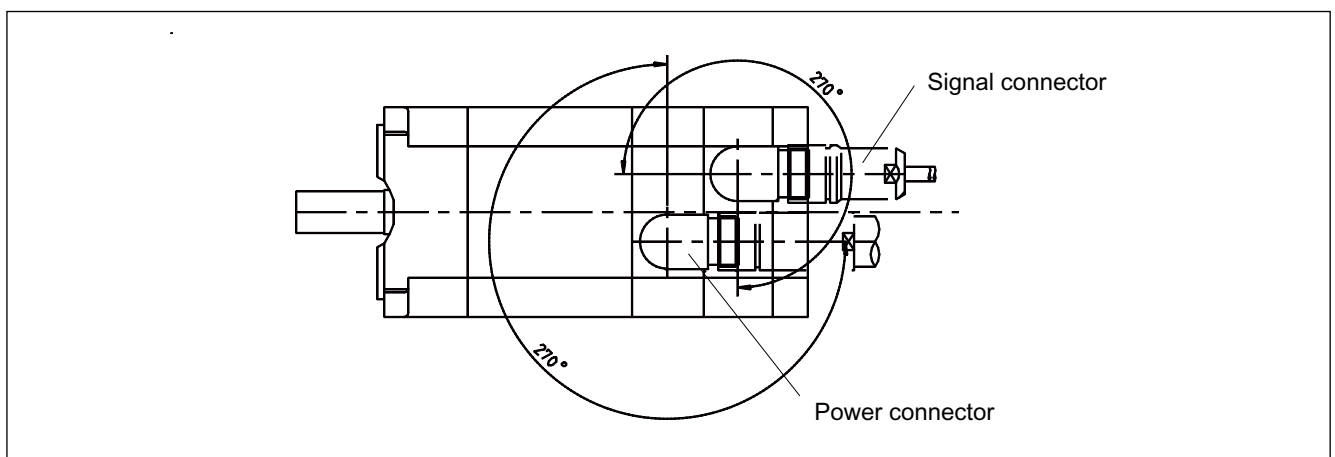

Figure 2-8 Rotating a connector using an 1FK706 motor as an example

Mechanical data

Bearing version

The motors have grease-lubricated ball bearings (life lubricated). The bearings are sealed at both ends and designed for a minimum ambient temperature in operation of -15 °C.

Note

We recommend that the bearings are replaced after approx. 20 000 operating hours, however, at the latest after 5 years.

Shaft end

The cylindrical shaft ends according to DIN 748 (IEC 60072) can either be ordered with or without key. The force-locked shaft-hub coupling is preferred for fast acceleration and reversing operation of the drives.

Mechanical turning

It is not possible to mechanically move the axis at the non-drive end of the motor. If the drive is to be manually rotated, then this should be done at a mechanically accessible position (e.g. ball screw spindle).

Smooth running, concentricity and axial eccentricity

The motors are tested in compliance with DIN 42955 (IEC 60072-1).

Vibration severity grade A (acc. to EN 60034-14, IEC 60034-14)

The specified values only refer to the motor. These values can be increased at the motor due to the overall vibration characteristics of the complete system after the drive has been mounted.

The vibration complies with the severity grade up to rated speed.

Balancing (acc. to DIN ISO 8821) for motors with key

Motors with key in the shaft are half-key balanced. A mass equalization for the protruding half key must be taken into account for the drive-out elements.

Electrical data

4.1 Torque-speed characteristic

The permissible operating range is limited by thermal, mechanical, and electromagnetic boundaries.

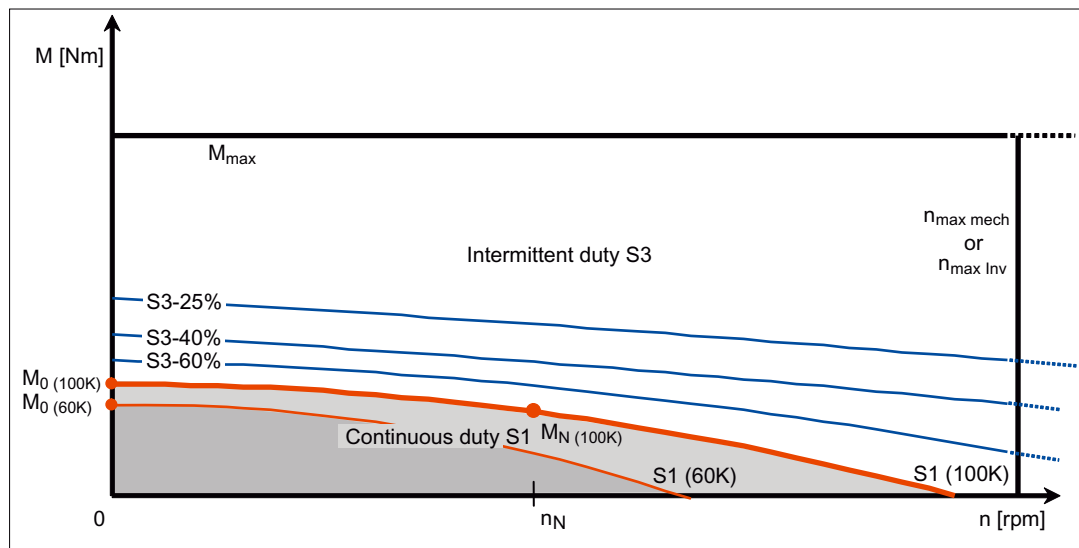

Figure 4-1 Torque characteristics of synchronous motors

Permissible temperature range, 100 K-, 60 K-values

The temperature rise of the motor is caused by the losses generated in the motor (current-dependent losses, no-load losses, friction losses). It is dependent on the cooling method (self-cooled, forced ventilation, water-cooled).

155 °C corresponds to a utilization according to temperature class F.

1FK7 motors can be operated up to an average winding temperature of 140 °C.

A maximum permissible ambient temperature of 40 °C for self-cooled motors generally applies to all specifications.

100 K or 60 K is the average winding temperature rise in Kelvin.

60 K lies in the utilization within temperature Class B. The 60 K utilization is used:

- if the temperature of the enclosure/housing must lie below 90 °C for safety reasons
- or the shaft temperature rise would have a negative impact on the mounted machine

4.2 Voltage limiting characteristics

Torque characteristics of motor

The maximum permissible torque is dependent on the permissible overtemperature and, thus, on the duty. To adhere to the temperature limits, the torque must be reduced as the speed increases, starting from static torque M_0 .

The characteristic curves are specified for continuous operation S1 (100 K), S1 (60 K) duty and periodic intermittent operation S3-25%, S3-40%, S3-60% duty with a cycle time of 10 minutes, except for small motors, for which a cycle time of 1 minute is specified and noted in the characteristic curves.

For more information about the duty cycles, refer to the section on Dimensioning.

A transient, high overload capacity up to M_{max} is provided over the complete speed setting range.



Warning

Continuous duty in the area above the S1 characteristic curve is not thermally permitted for the motor.

The speed range is limited by the mechanical limit speed $n_{max\ mech}$ (centrifugal forces at the rotor, bearing service life) or the electrical limit speed $n_{max\ Inv}$ (withstand voltage of converter and/or motor).

4.2 Voltage limiting characteristics

Armature circuit

Several armature circuit versions (winding versions) for different rated speeds n_N are possible within a motor frame size.

Table 4-1 Code letter, winding version

Rated speed n_N [RPM]	Winding version (10. position of the Order No.)
2000	C
3000	F
4500	H
6000	K

Converter output voltage

The converter output voltages differ according to the converter type and supply voltage.

Table 4-2 Converter voltages

Converter type	Infeed module	Supply voltage	DC link voltage	Output voltage
		U_{supply}	$U_{\text{DC link}}$	U_{mot}
SINAMICS S 120 3AC 380 - 480 V	ALM	400 V	600 V	425 V
	SLM	400 V	528 V	380 V
	SLM	480 V	634 V	460 V
SINAMICS S 120 1AC 230 V	AC/AC device	230 V	300 V	180 V

Torque limit for operation on converter without field weakening option

The voltage induced in the motor winding increases as the speed increases. The difference between the DC link voltage of the converter and the induced motor voltage can be used to apply the current.

For converters **without field weakening option**, this limits the amount of applicable current. This causes the torque to drop off quickly at high speeds. All operating points that can be achieved with the motor lie to the left of the voltage limiting characteristic line.

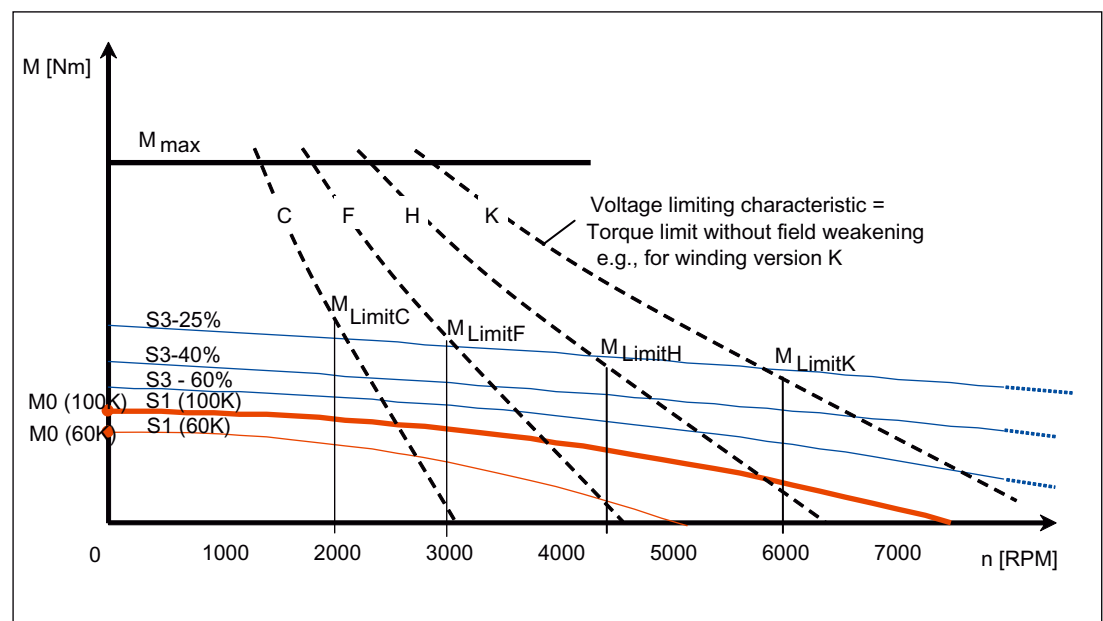

Figure 4-2 Speed-torque diagram, examples for various winding versions

The shape of the voltage limiting characteristic curve is determined by the winding version (armature circuit) and the magnitude of the converter output voltage.

4.2 Voltage limiting characteristics

The characteristic curve is plotted for each armature circuit in a separate data sheet. The torque-speed diagrams for different converter output voltages are then assigned to each data sheet.

Note

The voltage limit characteristic of a motor with 6000 RPM rated speed lies far above that of the same motor type with 2000 RPM. However, for the same torque, this motor requires a significantly higher current.

For this reason, you should select the rated speed such that it does not lie too far above the maximum speed required for the application.

The size (rating) of the converter module (output current) can be minimized in this fashion

Offset of the voltage limit characteristic

Notice

The offset of the voltage limiting characteristic applies only in the case of approximately linear limiting characteristic curves, e.g. for 1FK7 motors.

In order to identify the limits of the motor for a converter output voltage (U_{mot}) other than 380 V, 425 V, or 460 V, the relevant voltage limiting characteristic curve must be shifted (offset) for the particular new output voltage ($U_{mot, new}$).

The degree of offset is obtained as follows:

For an output voltage of $U_{mot, new}$, an offset is obtained along the X axis (speed) by a factor of:

$$\frac{V_{mot, new}}{V_{mot}} \quad U_{mot, new} = \text{new converter output voltage}$$
$$\quad \quad \quad U_{mot} = \text{drive converter output voltage from the characteristic curve for 380 V, 425 V, or 460 V}$$

Notice

It is only possible to shift the voltage limiting characteristic, if the condition

$U_{mot, new} > U_{iN}$ is fulfilled.

The induced voltage U_{iN} is specified on the motor rating plate.

$$U_{iN} = k_E \cdot n_N / 1000$$

Calculating the new limit torque with the new limiting characteristic

$$M_{\text{limit, new}} = \frac{V_{\text{mot, new}} - V_{iN}}{V_{\text{Mot}} - V_{iN}} \cdot M_{\text{limit}}$$

The value M_{limit} is read-off from the limiting characteristic curve for U_{mot} (value at the rated speed).

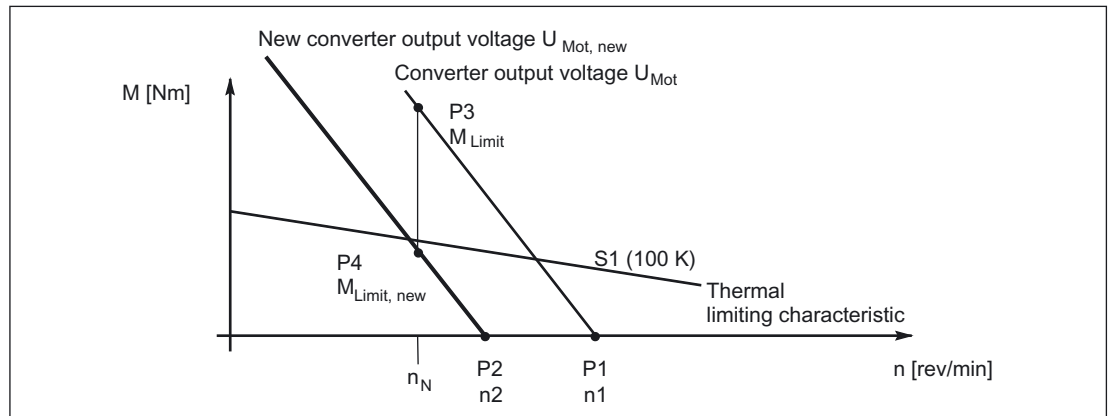

Figure 4-3 Offset of voltage limiting characteristic from U_{mot} to $U_{\text{mot, new}}$

P1 The voltage limiting characteristic curve specified for U_{mot} intersects with the x-axis (speed) at n_1 [RPM].

P2 Offset from point where the voltage limiting characteristic curve intersects with the x axis from n_1 to n_2 .

$$n_2 [1/\text{min}] = n_1 \cdot \frac{V_{\text{Mot, new}}}{V_{\text{Mot}}}$$

P3 Read-off M_{limit} on the voltage limiting characteristic curve specified for U_{mot} .

Calculating $M_{\text{limit, new}}$:

$$M_{\text{limit, new}} = \frac{V_{\text{mot, new}} - V_{iN}}{V_{\text{Mot}} - V_{iN}} \cdot M_{\text{limit}}$$

P4 $M_{\text{limit, new}}$

The offset voltage limiting characteristic curve is obtained with points P2 and P4.

Example of offset of voltage limiting characteristic curve without field weakening

Motor 1FK7032-5AK71; $k_E = 45 \text{ V/1000 RPM}$

$U_{\text{mot, new}} = 290 \text{ V}$; calculated with $U_{\text{mot}} = 425 \text{ V}$

$U_{\text{iN}} = k_E \cdot n_{\text{N}}/1000$; $U_{\text{iN}} = 45 \cdot 6000/1000 = 270 \text{ V}$

Condition: $U_{\text{mot, new}} > U_{\text{iN}}$ is fulfilled.

Calculation P1: $n_1 = \frac{425}{45} \cdot 1000 \text{ RPM} = 9444 \text{ RPM}$

Calculation P2: $n_2 = \frac{290}{425} \cdot 9444 \text{ RPM} = 6444 \text{ RPM}$

Calculation P3: M_{Limit} for 425 V and $n_{\text{N}} = \text{read-off } 6000 \text{ RPM} = 3.25 \text{ Nm}$

Calculation P4: $M_{\text{Limit, new}} = \frac{290 - 270}{425 - 270} \cdot 3.25 \text{ Nm} = 0.42 \text{ Nm}$

Enter and connect points P2 and P4. This line is the new voltage limiting characteristic curve for converter output voltage $U_{\text{mot, new}}$.

4.3 Field weakening mode

The SINAMICS S120 converter injects a field weakening current which means that the motor can operate above the voltage limiting characteristic without field weakening. The method used by the converter to inject the field weakening current has a significant influence on the curve characteristic.

Torque limit for operation on converter with field weakening option

The characteristics shown apply to operation on a SINAMICS S120 converter.

Field weakening mode is always active on a SINAMICS S120 converter.

The shape of the characteristics in field weakening mode depends on the position of the voltage limiting characteristic. A torque/speed chart is therefore assigned to each voltage limiting characteristic.

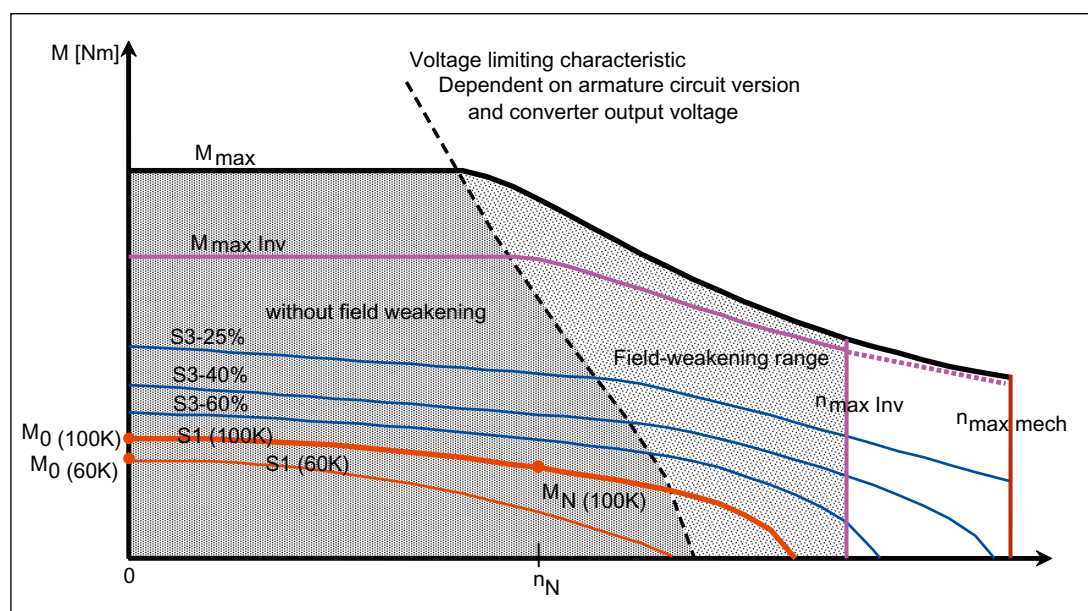

Figure 4-4 Torque characteristic of a synchronous motor operating on a converter with field weakening (example characteristic)

The permissible speed range has been limited to $n_{\max \text{ Inv}}$.

Recommended converter

Characteristic $M_{\max \text{ Inv}}$ shows the operating range which can be achieved with the recommended converter. The recommended converter is dimensioned to allow the motor to operate in the S1(100K) mode shown. If the application requires a torque up to M_{\max} , the converter selected must be capable of delivering the maximum current required to achieve M_{\max} .

The S1 and S3 characteristics apply to operation at the thermally permissible current. When configuring an S3 duty cycle, you must check that the converter can deliver the peak current required. It may be necessary to choose a larger converter.

When a smaller converter is used, the characteristics specified for field weakening operation cannot be achieved.

Speed limit $n_{\max \text{ Inv}}$



Caution

When the machine is running (with shaft operated by motor or separately driven) at speeds higher than $n_{\max \text{ Inv}}$, a voltage in excess of the maximum permissible converter voltage might be induced in the winding. This can cause irreparable damage to the converter.



Caution

The motor must not be operated at speeds higher than $n_{\max \text{ Inv}}$ unless additional protective measures are implemented. Siemens AG will not accept liability for any type of damage resulting from this particular cause.

4.4 Definitions

Rated speed n_N

The characteristic speed range for the motor is defined in the speed-torque diagram by the rated speed.

Number of poles $2p$

Number of magnetic north and south poles on the rotor. p is the number of pole pairs.

Rated torque M_N

Thermally permissible continuous torque in S1 duty at the rated motor speed.

Rated current I_N

RMS motor phase current for generating the particular rated torque. Specification of the RMS value of a sinusoidal current.

Static torque M_0

Thermal limit torque at motor standstill corresponding to a utilization according to 100 K or 60 K. This can be output for an unlimited time when $n = 0$. M_0 is always greater than the rated torque M_N .

Stall current I_0

Motor phase current for generating the particular static torque. Specification of the RMS value of a sinusoidal current.

Moment of inertia J_{mot}

Moment of inertia of rotating motor parts.

Optimum operating point

Operating point at which the maximum continuous output of the motor is normally provided at high efficiency (see figure below).

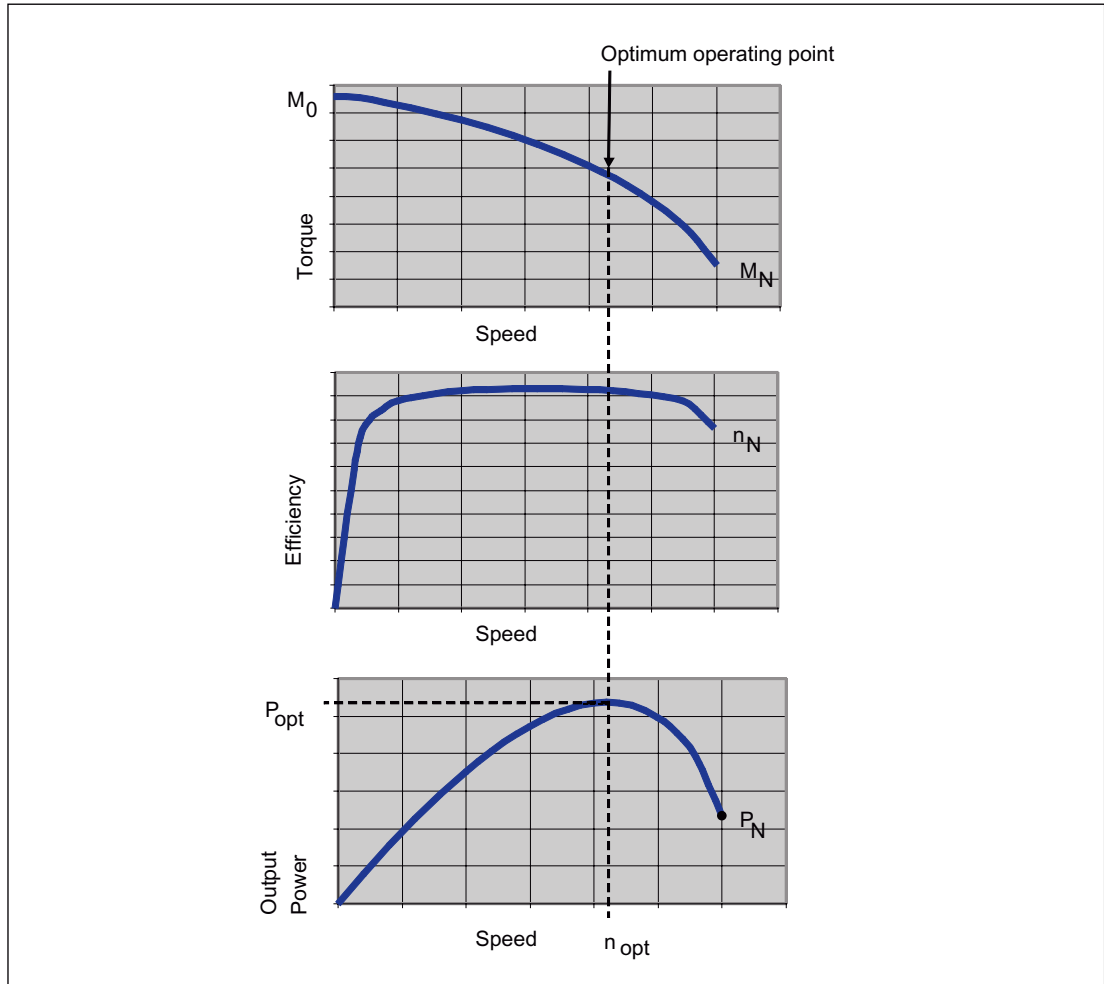

Figure 4-5 Optimum operating point

Optimum speed n_{opt}

Speed at which the optimum motor power is output.

If the rated speed is less than the optimum speed, the rated speed is indicated.

Optimum power P_{opt}

Power achieved at the optimum speed.

The rated speed is the optimum speed (see optimum speed), the optimum power corresponds to the rated power.

Maximum speed n_{\max}

The maximum permissible operating speed n_{\max} is the lesser of the maximum mechanically permissible speed and the maximum permissible speed at the converter.

Maximum permissible speed (mechanical) n_{\max} .

The maximum mechanically permissible speed is $n_{\max \text{ mech}}$. It is defined by the centrifugal forces and frictional forces in the bearing.

Maximum permissible speed at converter $n_{\max \text{ Inv}}$

The maximum permissible operating speed for operation at a converter is $n_{\max \text{ Inv}}$ (e.g., limited by withstand voltage, maximum frequency).

Maximum torque M_{\max}

Torque that is generated at the maximum permissible current.

The maximum torque is briefly available for high-speed operations (dynamic response to quickly change loads).

The maximum torque is limited by the closed-loop control parameters. If the current is increased, then the rotor will be de-magnetized.

Max. current $I_{\max, \text{RMS}}$

This current limit is only determined by the magnetic circuit. Even if this is briefly exceeded, it can result in an irreversible de-magnetization of the magnetic material. Specification of the RMS value of a sinusoidal current.

Torque constant k_T (value for a 100 K average winding temperature rise)

Quotient obtained from the static torque and stall current.

Calculation: $k_T = M_{0(100 \text{ K})} / I_{0(100 \text{ K})}$

The constant applies up to approx. $2 \cdot M_{0(60 \text{ K})}$ in the case of self-cooled motors

Note

This constant is not applicable when configuring the necessary rated and acceleration currents (motor losses!).

The steady-state load and the frictional torques must also be included in the calculation.

Voltage constant k_E (value at 20 °C rotor temperature)

Value of the induced motor voltage at a speed of 1000 RPM and a rotor temperature of 20 °C.

The phase-to-phase RMS motor terminal voltage is specified for 1FK7 motors.

Winding resistance R_{ph} at 20 °C winding temperature

The resistance of a phase at a winding temperature of 20 °C is specified. The winding has a star circuit configuration.

Cyclic inductance L_D

The cyclic inductance is the sum of the air gap inductance and leakage inductance relative to the single-strand equivalent circuit diagram. It consists of the self-inductance of a phase and the coupled inductance to other phases.

Electrical time constant T_{el}

Quotient obtained from the rotating field inductance and winding resistance. $T_{el} = L_D/R_{ph}$

Mechanical time constant T_{mech}

The mechanical time constant is obtained from the tangent at a theoretical ramp-up function through the origin.

$$T_{mech} = 3 \cdot R_{ph} \cdot J_{mot}/k_T^2 \text{ [s]}$$

$$J_{mot} = \text{Servomotor moment of inertia [kgm}^2\text{]}$$

$$R_{ph} = \text{Phase resistance of the stator winding [Ohm]}$$

$$k_T = \text{Torque constant [Nm/A]}$$

Thermal time constant T_{th}

Defines the increase in the motor frame temperature when the motor load is suddenly increased (step function) to the permissible S1 torque. The motor has reached 63% of its final temperature after T_{th} .

Shaft torsional stiffness c_T

This specifies the shaft torsional stiffness from the center of the rotor laminated core to the center of the shaft end.

Rated converter current $I_{N Inv}$

RMS converter output current (per phase) that can be supplied on a continuing basis by the recommended motor module. The recommended motor module is selected such that $I_{N Inv}$ is greater than the stall current I_0 (100 K).

Maximum converter current $I_{\max Inv}$

RMS converter output current (per phase) that can be supplied temporarily by the recommended motor module

Maximum torque (limited by converter) $M_{\max Inv}$

The maximum torque that can be applied (temporarily) for operation on the recommended motor module.

Typical M/I characteristic

The torque can be calculated linearly from the current but is subject to conditions (saturation effects, etc.).

The left characteristic curve is regarded as the "best case", and the right characteristic curve as the "worst case".

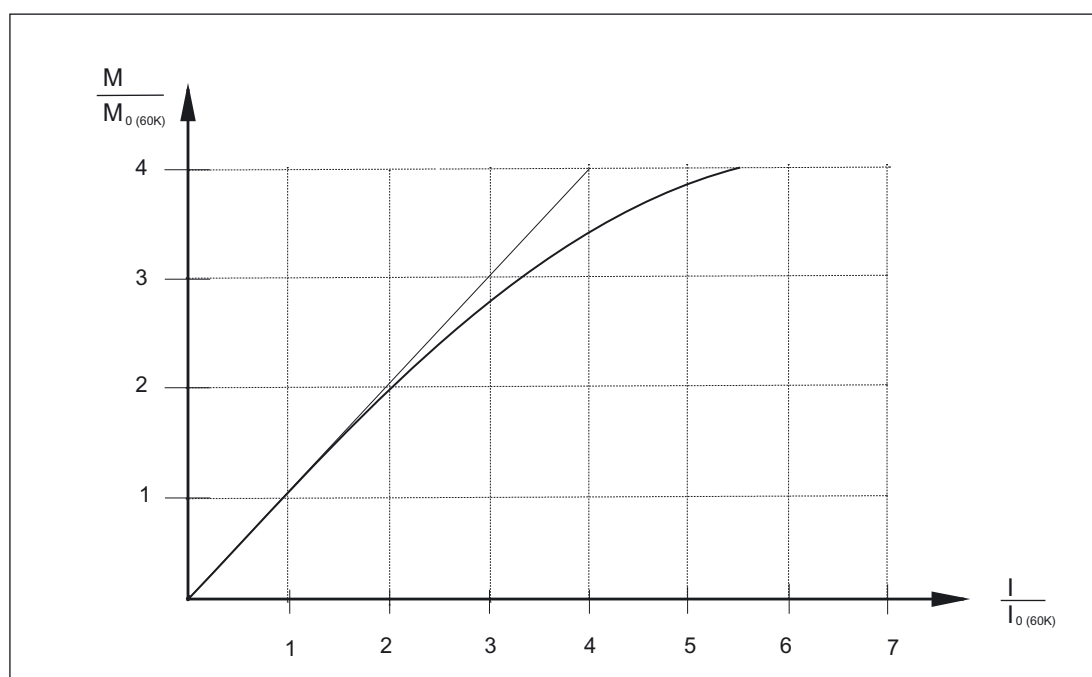

Figure 4-6 Torque-current characteristic curve for self-cooled motors

Braking resistance R_{opt}

R_{opt} corresponds to the optimum resistance value per phase that is switched in series external to the motor winding for the armature short-circuit braking function.

Braking torque $M_{b, opt}$

$M_{b, opt}$ corresponds to the average, optimum braking torque that is achieved through the upstream braking resistance R_{opt} .

Tolerance data

(data going beyond this are subject to a specific measuring accuracy)

Table 4-3 Tolerance data in the motor list data

Motor list data		Typ. value	Theoretical value
Stall current	I_0	$\pm 3 \%$	$\pm 7,5 \%$
Electrical time constant	T_{el}	$\pm 5 \%$	$\pm 10 \%$
Torque constant	k_T	$\pm 3 \%$	$\pm 7,5 \%$
Voltage constant	k_E	$\pm 3 \%$	$\pm 7,5 \%$
Winding resistance	$R_{ph.}$	$\pm 5 \%$	$\pm 10 \%$
Moment of inertia	J_{mot}	$\pm 2 \%$	$\pm 10 \%$

Configuration

5.1 Engineering software

5.1.1 SIZER engineering tool

Overview

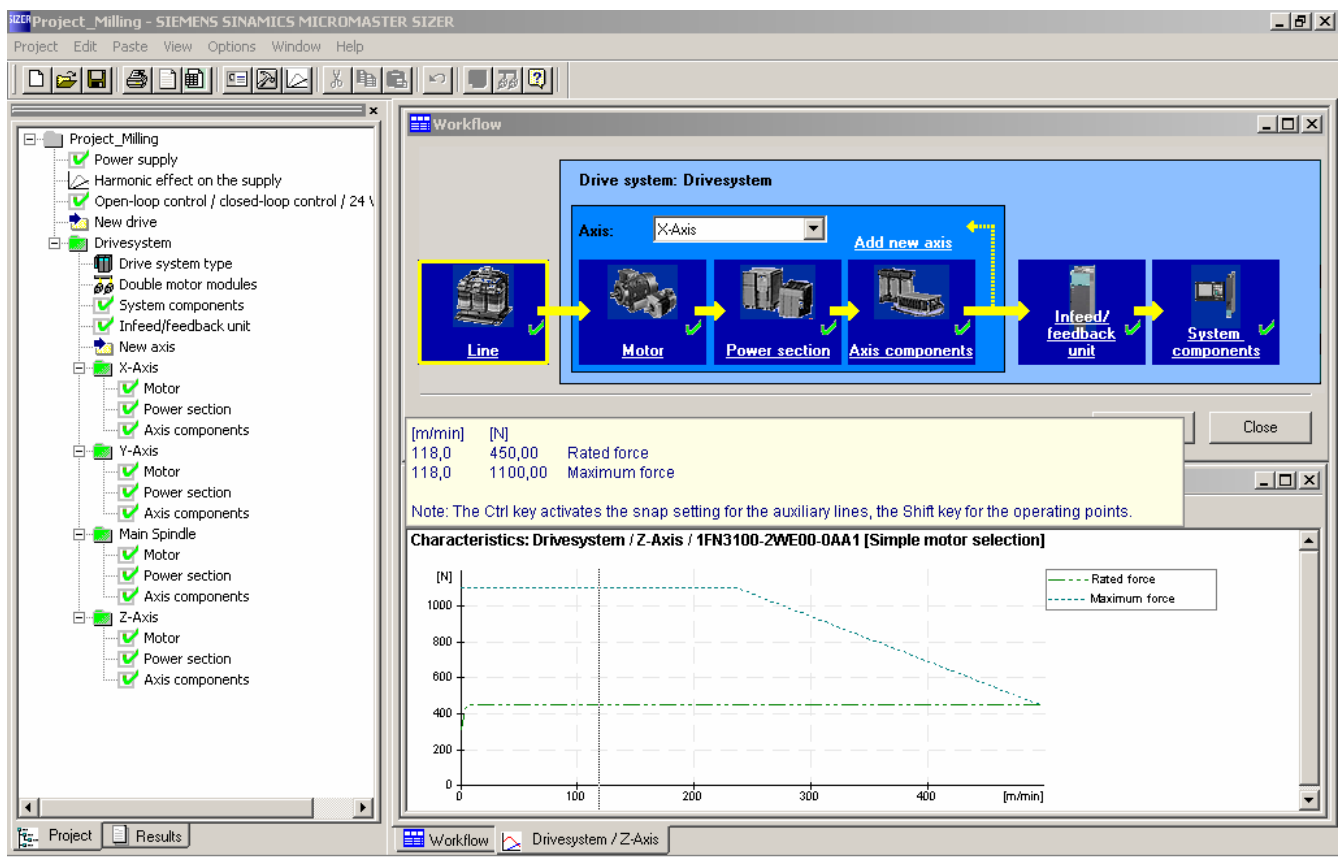

Figure 5-1 SIZER

The SIZER configuration tool provides an easy-to-use means of configuring the SINAMICS and MICROMASTER 4 drive families, as well as the SINUMERIK solution line CNC control and SIMOTION Motion Control system. It provides support when setting up the technologies involved in the hardware and firmware components required for a drive task. SIZER supports the configuration of the complete drive system, from simple individual drives to complex multi-axis applications.

SIZER supports all of the engineering steps in a workflow:

- Selection of the power supply
- Motor design as a result of load configuring
- Calculation of the drive components
- Compiling the required accessories
- Selection of the line-side and motor-side power options

When SIZER was being designed, particular importance was placed on a high degree of usability and a universal, function-based approach to the drive application. The extensive user navigation makes it easy to use the tool. Status information keeps you continually informed about how engineering is progressing.

The SIZER user interface is available in German and English. The drive configuration is saved in a project. In the project, the components and functions used are displayed in a hierarchical tree structure. The project view permits the configuration of drive systems and the copying/inserting/modifying of drives already configured.

The configuration process produces the following results:

- A parts list of the components required
- Technical data
- Characteristics
- Comments on system reaction
- Location diagram and dimension drawings

These results are displayed in a results tree and can be reused for documentation purposes. User support is provided by technological online help, which provides the following information:

- Detailed technical data
- Information about the drive systems and their components
- Decision-making criteria for the selection of components.

Minimum hardware and software requirements

- PG or PC with Pentium™ II 400 MHz (Windows™ 2000), Pentium™ III 500 MHz (Windows™ XP)
- 256 MB RAM (512 MB recommended)
- At least 1150 MB free hard disk space, additional 100 MB free hard disk space on Windows system drive
- Monitor resolution, 1024×768 pixels
- Windows™ 2000 SP2, XP Professional SP1, XP Home Edition SP1
- Microsoft Internet Explorer 5.5 SP2

Selection and ordering data

Title	Order No. (MLFB)
Engineering tool SINAMICS MICROMASTER SIZER German/English	6SL3070-0AA00-0AG0

5.1.2 STARTER drive/commissioning software

Overview

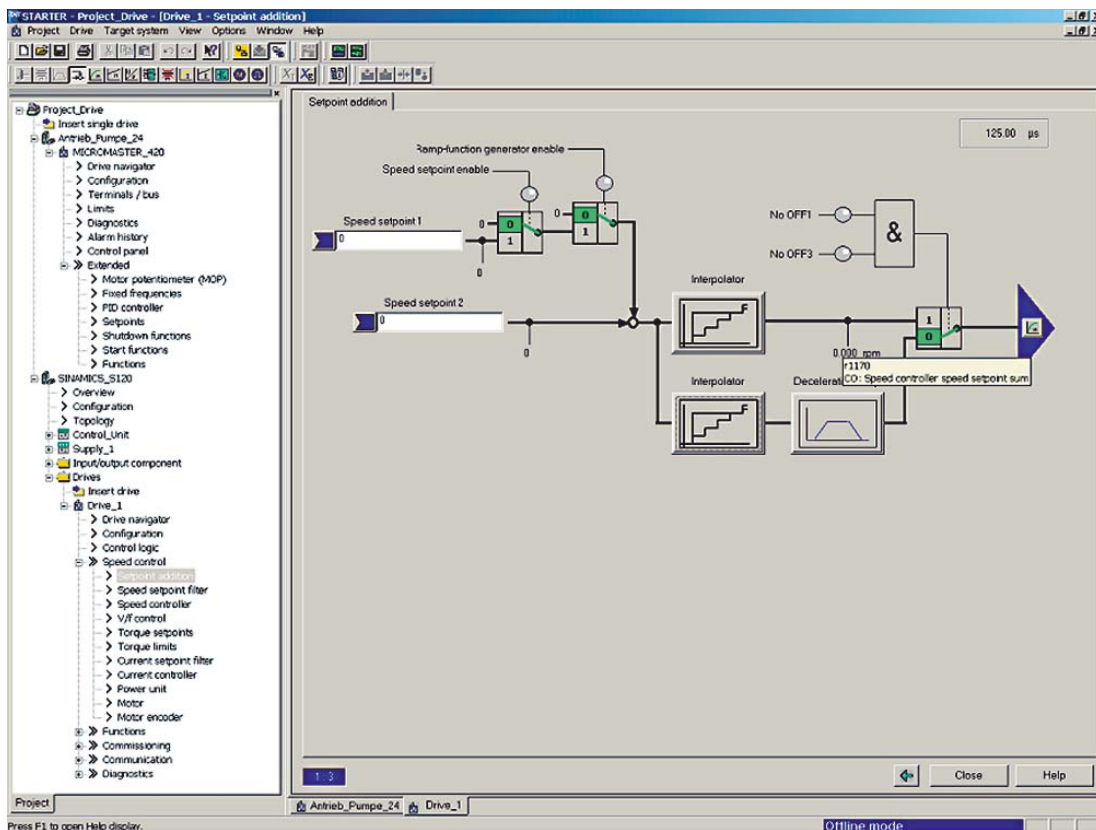

Figure 5-2 STARTER

The easy-to-use STARTER drive/commissioning tool can be used for:

- Commissioning,
- Optimization, and
- Diagnostics

This software can be operated either as a standalone PC application or can be integrated into the SCOUT engineering system (with SIMOTION) or STEP 7 (with Drive ES Basic). The basic functions and handling are the same regardless.

In addition to the SINAMICS drives, the current version of STARTER also supports MICROMASTER 4 devices and frequency converters for the SIMATIC ET 200S FC distributed I/O system.

The project wizards can be used to create the drives within the structure of the project tree.

Entry-level personnel are supported by solution-based dialog navigation, whereby a standard graphics-based display maximizes clarity when setting the drive parameters.

Wizards are used to navigate users when drives are being commissioning for the first time; these Wizards make all of the basic settings in the drive. This enables a drive to be up and running after only setting a small number of parameters within the drive configuration process.

The individual settings required are made using graphics-based parameter assignment screen forms, which also display the mode of operation.

Examples of individual settings that can be made include:

- Terminals
- bus interface
- Setpoint channel (e.g. fixed setpoints)
- Closed-loop speed control (e.g. ramp-function generator, limits)
- BICO interconnections
- Diagnostics.

Experts can gain rapid access to the individual parameters using the Expert List - this means that they do not have to navigate dialogs.

In addition, the following functions are available for optimization purposes:

- self-optimization
- Trace (depending on drive)

Diagnostics functions provide information about:

- Control/status words
- parameter status
- Operating conditions
- Communication states

Features

- Easy-to-use: Only a small number of settings need to be made for successful first commissioning: Axis rotates
- Solution-based user navigation simplifies commissioning
- Self-optimization functions reduce manual optimization work
- The built-in trace function provides optimum support during commissioning, optimization and troubleshooting.

Minimum hardware and software requirements

- PG or PC with Pentium™ II 400 MHz (Windows™ NT/2000), Pentium™ III 500 MHz (Windows™ XP)
- 256 MB RAM
- Monitor resolution, 1024×768 pixels
- Windows™ NT 4.0 SP6, 2000 SP3, XP Professional SP1
- Microsoft Internet Explorer 5.01

Selection and Ordering Data

Title	Order No. (MLFB)
STARTER commissioning tool for SINAMICS and MICROMASTER German / English / French / Italian	6SL3072-0AA00-0AG0

5.1.3 Engineering System Drive ES

Overview

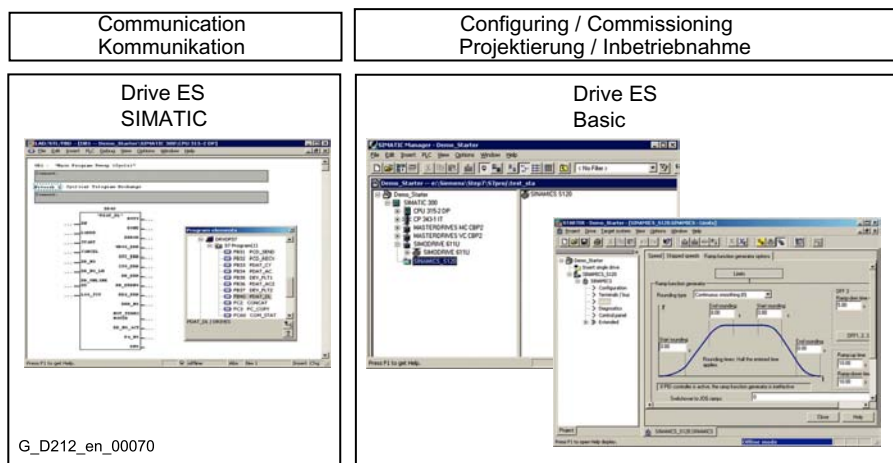

Figure 5-3 Drive ES

Drive ES is the engineering system used to easily integrate Siemens drive technology into the SIMATIC automation world easily, efficiently and cost-effectively in terms of communication, configuration and data management. The STEP 7 Manager user interface provides the basis for this procedure.

Various software packages are available for SINAMICS S120:

Drive ES Basic

For entry into the world of Totally Integrated Automation and the possibility of using routing beyond network boundaries and also SIMATIC teleservice.

Drive ES Basic is the basic software to parameterize all of the drives both online and offline.

Using Drive ES Basic, the automation and the drives are processed on the SIMATIC Manager screen. Drive ES Basic is the starting point for common data archiving for complete projects and for extending the use of the SIMATIC teleservice to drives. Drive ES Basic provides the engineering tools for the new motion control functions - peer-to-peer data traffic, equidistance and isochronous operation with PROFIBUS DP.

Drive ES SIMATIC

Easy parameter assignment of the STEP 7 communications program instead of programming.

Drive ES SIMATIC requires that STEP 7 has first been installed. It incorporates a SIMATIC block library; this means that the PROFIBUS interface can be simply and reliably programmed in the SIMATIC CPU for the drives.

The separate, time consuming programming of the data exchange functions between the SIMATIC-CPU and the drive is eliminated.

For Drive ES users, it is as simple as this:

Copy – Adapt – Load – Ready.

Harmonized, proven function blocks are transferred from the library into your project.

Frequently required functions are completely programmed:

- Complete diagnostic buffers are automatically read from the drive
- Complete parameter sets are automatically downloaded into the drive from the SIMATIC CPU – e.g. when a device has to be replaced.
- Part parameter sets (e.g. for recipe and product change) are automatically downloaded into the drive from the SIMATIC-CPU
- Complete parameter assignment or partial parameter sets are uploaded from the drive into the SIMATIC-CPU, i.e. updated.

Drive ES PCS 7

integrates drives with PROFIBUS interface into the SIMATIC PCS 7 process control system.

Drive ES PCS 7 requires a pre-installed SIMATIC PCS 7 process control system from Version 5.2 onwards. Drive ES PCS 7 provides a function block library with function blocks for the drives and the corresponding faceplates for the operator station. This means that the drives can be operated from the PCS 7 process control system.

For further information please visit us on the Internet at:

<http://www.siemens.com/drivesolutions>

Selection and Ordering Data

Table 5-1 Selection and ordering data for Drive ES engineering system

Description	Order No. (MLFB)
Drive ES Basic V 5.4	
<ul style="list-style-type: none"> • Engineering software for integration of drives into Totally Integrated Automation • Prerequisites: STEP 7 V 5.3 SP 3, or higher • Form of delivery: on CD-ROM ge, en, fr, sp, it with electronic documentation 	
Single license	6SW1700-5JA00-4AA0
Multi-user license, 60x	6SW1700-5JA00-4AA1
Update service for single-user license	6SW1700-0JA00-0AB2
Update service for multi-user license	6SW1700-0JA00-1AB2
Upgrade from V 5.x to V 5.4	6SW1700-5JA00-4AA4
Drive ES SIMATIC V 5.4	
<ul style="list-style-type: none"> • Block library for SIMATIC for parameter assignment for communication with the drives • Prerequisites: STEP 7 V 5.3 SP 3, or higher • Form of delivery: on CD-ROM ge, en, fr, sp, it with electronic documentation 	
Single-user license incl. 1 x runtime license	6SW1700-5JC00-4AA0
Runtime License	6SW1700-5JC00-1AC0
Update service for single-user license	6SW1700-0JC00-0AB2
Upgrade from V 5.x to V 5.4	6SW1700-5JC00-4AA4
Drive ES PCS 7 V 6.1	
<ul style="list-style-type: none"> • Block library for PCS 7 for integration of drives • Prerequisites: PCS 7 V 6.1 or higher • Form of delivery: on CD-ROM ge, en, fr, sp, it with electronic documentation 	
Single-user license incl. 1 x runtime license	6SW1700-6JD00-1AA0
Runtime License	6SW1700-5JD00-1AC0
Update service for single-user license	6SW1700-0JD00-0AB2
Upgrade from V 5.x to V 6.1	6SW1700-6JD00-1AA4

5.2 SINAMICS configuring sequence, suppress title

The function description of the machine provides the basis when engineering the drive application. The definition of the components is based on physical interdependencies and is usually carried-out as follows:

step	Description of the engineering activity	Refer to Chapter
1.	Clarification of the type of drive	5.3.1
2.	Definition of the load, calculation of max. load torque	5.3.2
3.	Specification of the motor	5.3.3
4.	The SINAMICS Motor Module is selected	Refer to the converter catalog
5.	Steps 3 and 4 are repeated for additional axes	
6.	The required DC link power is calculated and the SINAMICS Line Module is selected	
7.	Specification of the required control performance and selection of the Control Unit, definition of component cabling	
8.	The line-side options (main switch, fuses, line filters, etc.) are selected	
9.	Additional system components are defined and selected	
10.	The current demand of the 24 V DC supply for the components is calculated and the power supplies (SITOP devices, control supply modules) specified	
11.	The components for the connection system are selected	
12.	The components of the drive group are configured to form a complete drive	
13.	Required cable cross sections for power supply and motor connections	
14.	Mandatory installation clearances	

Configuration begins with the mechanical interface to the machine. A suitable motor is selected according to the specified torques and speeds. A matching power unit is then also chosen. Depending on the requirements of the machine, the motor is supplied as a single drive via a Power Module or within a multi-motor drive group via a Motor Module. Once the basic components have been defined, the system components for matching to the electrical and mechanical interfaces are selected.

The SIZER configuring tool helps the user to select the correct components quickly and easily. The user enters the relevant torque and speed characteristics and SIZER then guides him confidently through the configuring process, identifying suitable motors and matching SINAMICS power units and other system components.

5.3 Dimensioning

5.3.1 1. Clarification of the type of drive

The motor is selected on the basis of the required torque, which is defined by the application, e.g. traveling drives, hoisting drives, test stands, centrifuges, paper and rolling mill drives, feed drives or main spindle drives. Gear units to convert motion or to adapt the motor speed and motor torque to the load conditions must also be considered.

As well as the load torque, which is determined by the application, the following mechanical data are among those required to calculate the torque to be provided by the motor:

- Masses moved
- Diameter of the drive wheel/diameter
- Leadscrew pitch, gear ratios
- Frictional resistance
- Mechanical efficiency
- Traversing paths
- Maximum velocity
- Maximum acceleration and maximum deceleration
- Cycle time

You must decide whether synchronous or induction motors are to be used.

Synchronous motors are the best choice if it is important to have low envelope dimensions, low rotor moment of inertia and therefore maximum dynamic response.

In this context, suitable motors would be the 1FK7 and 1FT7, which can be operated in "Servo" control mode.

The following factors are especially important when engineering a drive application:

- The line system configuration, when using specific types of motor and/or line filters on IT systems (non-grounded systems)
- The ambient temperatures and the installation altitude of the motors and drive components.

The motor-specific limiting characteristics provide the basis for defining the motors.

These define the torque or power characteristic versus the speed and take into account the motor limits based on the DC-link voltage of the power or motor module. The DC-link voltage, in turn, is dependent on the supply voltage and, with multi-motor drives, on the type of the line module.

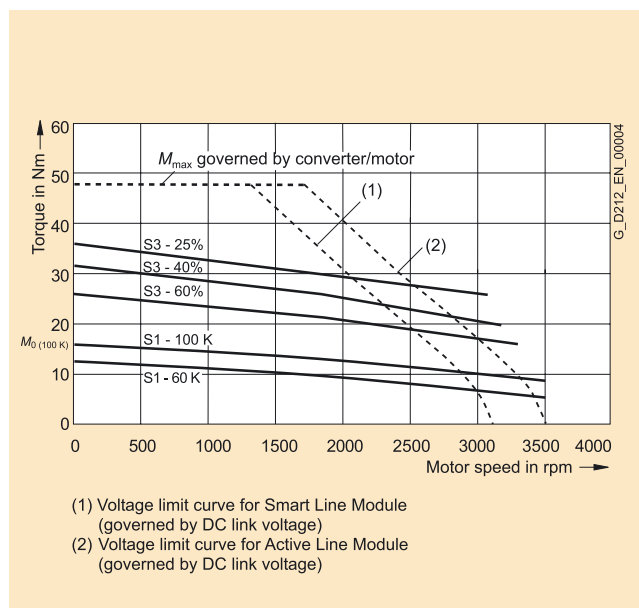

Figure 5-4 Limit curves for synchronous motors

5.3.2 2. Definition of the load event, calculation of max. load torque

Load duty cycles

The motor is selected based on the load which is specified by the application. Different characteristic curves must be used for different load events.

The following operating scenarios have been defined:

- Load duty cycle with constant ON period
- Load duty cycles with varying ON period
- Free duty cycle

The objective is to identify characteristic torque and speed operating points, on the basis of which the motor can be selected depending on the particular load.

Once the operating scenario has been defined and specified, the maximum motor torque is calculated. Generally, the maximum motor torque is required when accelerating. The load torque and the torque required to accelerate the motor are added.

The maximum motor torque is then verified with the limiting characteristic curves of the motors.

The following criteria must be taken into account when selecting the motor:

- The dynamic limits must be adhered to, i.e., all speed-torque points of the relevant load event must lie below the relevant limiting characteristic curve.
- The thermal limits must be adhered to, i.e. for synchronous motors, the RMS motor torque at the average motor speed resulting from the duty cycle must lie below the S1 characteristic curve (continuous duty). For induction motors, the RMS value of the motor current within a duty cycle must be less than the rated motor current.

- It should be noted that the maximum permissible motor torque on synchronous motors at higher speeds is reduced as a result of the voltage limiting characteristic. In addition, a margin of 10% below the voltage limiting characteristic should be maintained to safeguard against voltage fluctuations.
- When using induction motors, the permissible motor torque in the field-weakening range is restricted by the voltage limiting characteristic (stability limit). A margin of 30 % should be observed.

Load duty cycles with constant on period

For duty cycles with constant ON period, there are specific requirements for the torque characteristic curve as a function of the speed:

e.g. $M = \text{constant}$, $M \sim n^2$, $M \sim n$ or $P = \text{constant}$.

These drives typically operate at a specific operating point. Drives such as these are dimensioned for a base load. The base load torque must lie below the S1 characteristic curve.

In the event of transient overloads (e.g. when accelerating) an overload has to be taken into consideration. The peak torque must lie below the voltage limiting characteristic curve for synchronous motors or below the stability limit for induction motors.

In summary, the motor is selected as follows:

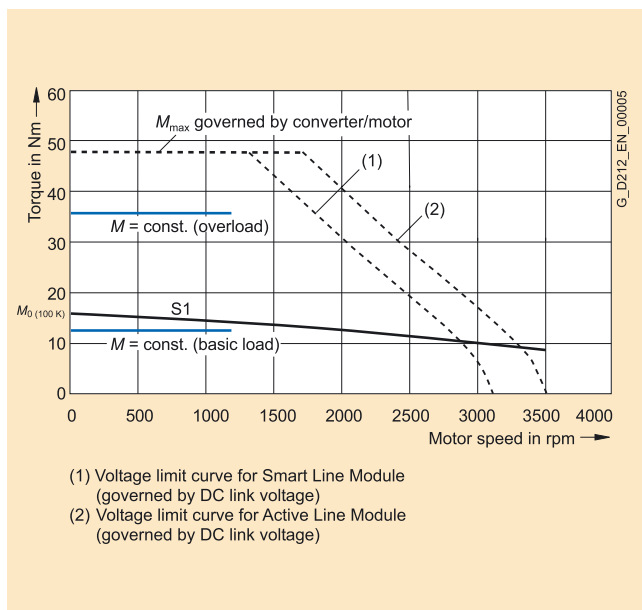

Figure 5-5 Selection of motors for load duty cycles with constant on period (examples)

Load duty cycles with varying on period

As well as continuous duty (S1), standard intermittent duty types (S3) are also defined for load duty cycles with varying on periods. This involves operation that comprises a sequence of similar load cycles, each of which comprises a time with constant load and an off period.

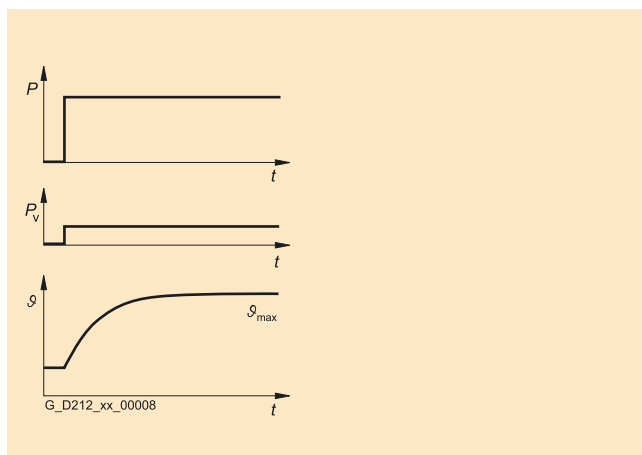

Figure 5-6 S1 duty (continuous operation)

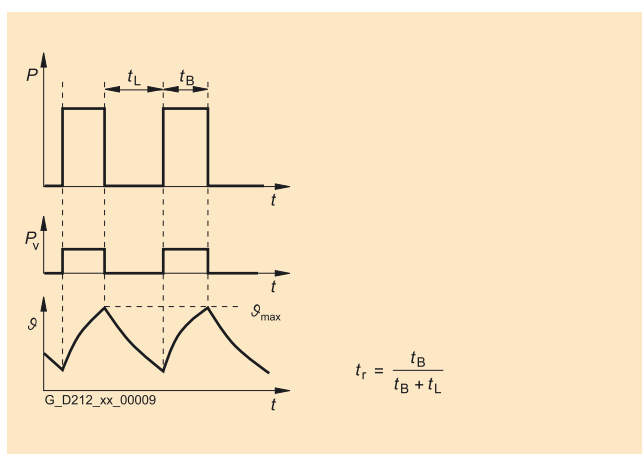

Figure 5-7 S3 duty (intermittent operation without influencing starting)

Fixed variables are usually used for the relative on period:

- S3 – 60%
- S3 – 40%
- S3 – 25%

The corresponding motor characteristics are provided for these specifications. The load torque must lie below the corresponding thermal limiting characteristic curve of the motor. An overload must be taken into consideration for load duty cycles with varying on periods.

Load cycle

A load duty cycle defines the characteristics of the motor speed and the torque with respect to time.

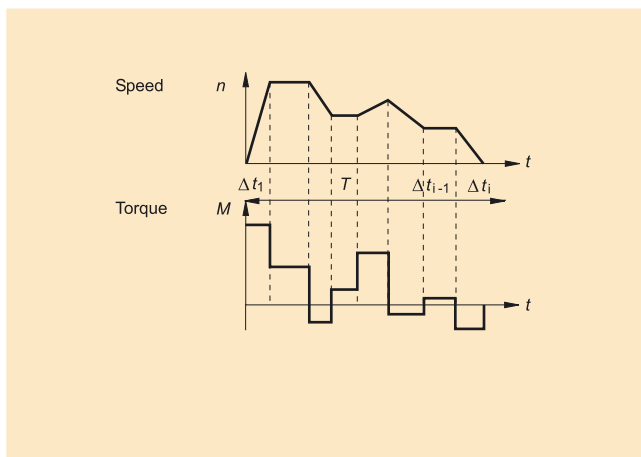

Figure 5-8 Example of a load duty cycle

A load torque is specified for each time period. In addition to the load torque, the average load moment of inertia and motor moment of inertia must be taken into account for acceleration. It may be necessary to take into account a frictional torque that opposes the direction of motion.

The gear ratio and gear efficiency must be taken into account when calculating the load and/or accelerating torque to be provided by the motor. A higher gear ratio increases positioning accuracy in terms of encoder resolution. For any given motor encoder resolution, as the gear ratio increases, so does the resolution of the machine position to be detected.

For the motor torque in a time slice Δt_i the following applies:

$$M_{\text{Mot}, i} = (J_M + J_G) \cdot \frac{2\pi}{60} \cdot \frac{\Delta n_{\text{Last}, i}}{\Delta t_i} \cdot i + (J_{\text{Last}} \cdot \frac{2\pi}{60} \cdot \frac{\Delta n_{\text{Last}, i}}{\Delta t_i} + M_{\text{Last}, i} + M_R) \cdot \frac{1}{i \cdot \eta_G}$$

The motor speed is:

$$n_{\text{Mot}, i} = n_{\text{Last}, i} \cdot i$$

The RMS torque is obtained as follows:

$$M_{\text{Mot}, \text{eff}} = \sqrt{\frac{\sum M_{\text{Mot}, i}^2 \cdot \Delta t_i}{T}}$$

The average motor speed is calculated as follows:

$$n_{\text{Mot}, \text{mittel}} = \frac{\sum n_{\text{Mot}, k, A} + n_{\text{Mot}, k, E} \cdot \Delta t_i}{t_e}$$

J_M	Motor moment of inertia
J_G	Gearbox moment of inertia
J_{load}	Load moment of inertia
n_{Load}	Load speed
i	Gear ratio
η_G	Gearbox efficiency
M_{load}	Load torque
M_R	Frictional torque
T	Cycle time, clock cycle time
A; E	Initial value, final value in time slice Δt_i
t_e	ON period
Δt_i	Time interval

The RMS torque M_{rms} must lie below the S1 curve.

The maximum torque M_{max} is produced during the acceleration operation.

For synchronous motors, M_{max} must lie below the voltage limiting characteristic curve.

For induction motors, M_{max} must lie below the stability limit.

In summary, the motor is selected as follows:

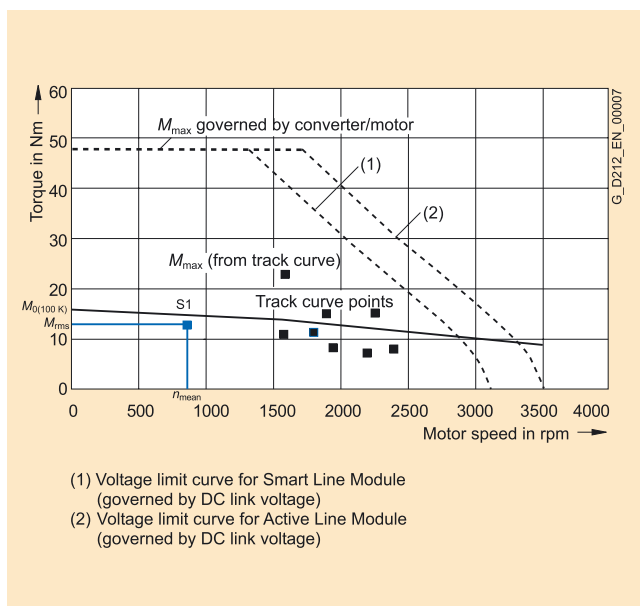

Figure 5-9 Selecting motors depending on the load duty cycle (example)

5.3.3 3. Specification of the motor

Through variation, it is now possible to identify a motor which meets the requirements of the application.

In a second step, a check is made as to whether the thermal limits are maintained. To do this, the motor current at the base load must be calculated. When configuring according to duty cycle with constant ON period with overload, the overload current must be calculated relative to the required overload torque.

The calculation depends on the type of motor used (synchronous motor, induction motor) and the particular application (duty cycle with constant ON period, free duty cycle).

Finally, the other motor features must be defined by configuring the motor options.

Motor components

6.1 Thermal motor protection

A temperature-dependent resistor is integrated as temperature sensor to monitor the motor temperature.

Table 6-1 Features and technical data

Type	KTY 84 (PTC thermistor)
Resistance when cold (20°C)	approx. 580 Ohm
Resistance when hot (100°C)	approx. 1000 Ohm
Connection	via signal cable

The resistance of the KTY 84 thermistor changes proportionally to the winding temperature change.

The temperature signal is sensed and evaluated in the drive converter whose closed-loop control takes into account the temperature characteristic of the motor resistances.

When a fault occurs, an appropriate message is output at the drive converter. When the motor temperature increases, a message "Alarm motor overtemperature" is output; this must be externally evaluated. If this signal is not observed, the drive converter shuts down with the appropriate fault message when the motor limiting temperature or the shutdown temperature is exceeded.



Warning

If the user carries-out an additional high-voltage test, then the ends of the temperature sensor cables must be short-circuited before the test is carried-out!

If the test voltage is connected to a temperature sensor terminal, then it will be destroyed.

The polarity must be carefully observed.

The temperature sensor is designed so that the DIN/EN requirement for "protective separation" is fulfilled.



Caution

The integrated temperature sensor protects the synchronous against an overload condition

Shaft height 11 to 48 to $2 \cdot I_{0(60K)}$ and speed $\neq 0$

From shaft height 63 up to $4 \cdot I_{0(60K)}$ and speed $\neq 0$

For load applications that are critical from a thermal perspective - e.g. overload when the motor is stationary or an overload of M_{max} longer than 4 s, adequate protection is no longer available.

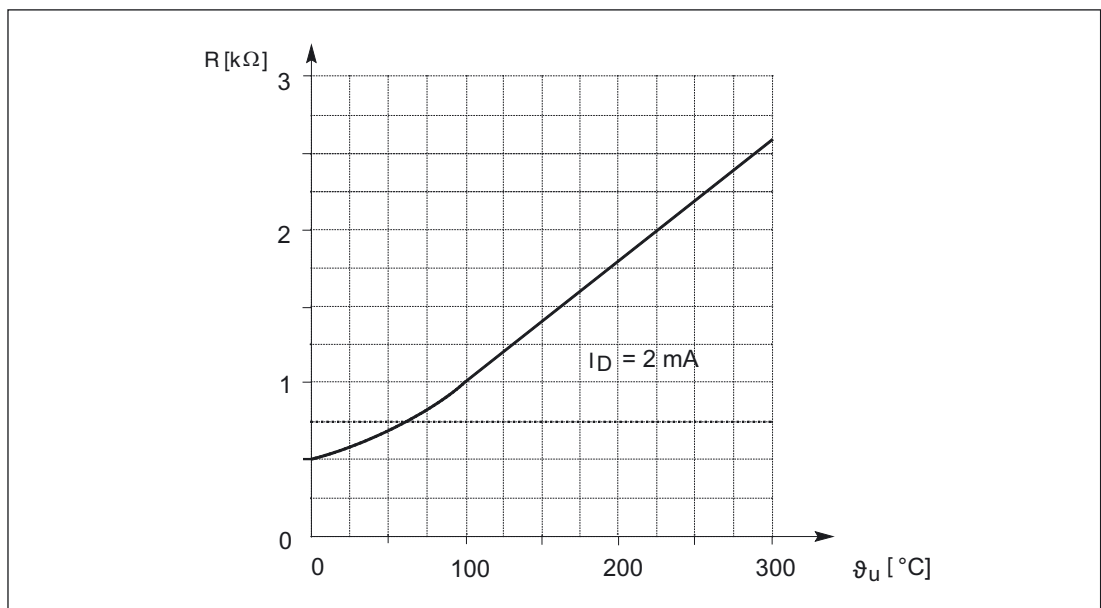

Figure 6-1 Resistance characteristic of the KTY 84 as a function of the temperature

6.2 Encoder (option)

6.2.1 Encoder overview

The encoder is selected in the motor Order No. (MLFB) using the appropriate letter at the 14th position. The letter ID at the 14th position of the Order No. (MLFB) differs for motors with an without DRIVE-CLiQ.

Table 6-2 Encoders for motors with DRIVE-CLiQ

Motor	Incremental encoders sin/cos 1 Vpp (I-2048)	Absolute encoders EnDat (A-2048)	Absolute encoder EnDat (A-512)	Simple absolute value encoders (A-32)	Resolvers 2-pole / multi-pole
1FK701□	See table "Encoders for motors with DRIVE-CLiQ"				
1FK702□	D		L		U / P
1FK703□	D		L		U / P
1FK704□	D	F		K	U / P
1FK706□	D	F		K	U / P
1FK708□	D	F		K	U / P
1FK710□	D	F		K	U / P

Table 6-3 Encoders for motors without DRIVE-CLiQ

Motor	Incremental encoders sin/cos 1 Vpp (I-2048)	Absolute encoders EnDat (A-2048)	Absolute encoder EnDat (A-512)	Simple absolute encoder (A-32)	Resolver 2-pole/ multi-pole
1FK701□	A		H		S / T
1FK702□	A		H		S / T
1FK703□	A		H		S / T
1FK704□	A	E		G	S / T
1FK706□	A	E		G	S / T
1FK708□	A	E		G	S / T
1FK710□	A	E		G	S / T

Notice

When the encoder is replaced, the position of the encoder system with respect to the motor EMF must be adjusted. Only qualified personnel may replace an encoder.

6.2.2 Encoder connection for motors with DRIVE-CLiQ

Motors with DRIVE-CLiQ have a sensor module that includes the encoder evaluation, the motor temperature sensing and an electronic rating plate.

This sensor module instead of the signal connector and has a 10-pin RJ45-plus socket.



Warning

The sensor module contains motor and encoder-specific data as well as an electronic rating plate. This is the reason that this sensor module may only be operated on the original motor - and may not be mounted onto other motors or replaced by a sensor module from other motors.

The sensor module has direct contact to components that can be destroyed by electrostatic discharge (ESDS). Neither hands nor tools that could be electrostatically charged may come into contact with the connections.

6.2.3 Encoder connection for motors without DRIVE-CLiQ

Motors without DRIVE-CLiQ are connected using the 17-pin flange socket.

6.2.4 Incremental encoders

Function:

- Angular measuring system for commutation
- Speed actual value sensing
- Indirect incremental measuring system for the position control loop
- One zero pulse (reference mark) per revolution

Table 6-4 Technical data for incremental encoder sin/cos 1 Vpp

Properties	Incremental encoders sin/cos 1 Vpp (I-2048)	Incremental encoders sin/cos 1 Vpp (low SH) (I-2048)
Mech. limiting speed	15000 RPM	12000 RPM
Operating voltage	5 V ± 5 %	5 V ± 5 %
Current consumption	max. 150 mA	max. 150 mA
Incremental resolution (periods per revolution)	2048	2048
Incremental signals	1 Vpp	1 Vpp
Angular error	± 40"	± 80"
C-D track (rotor position)	available	Available

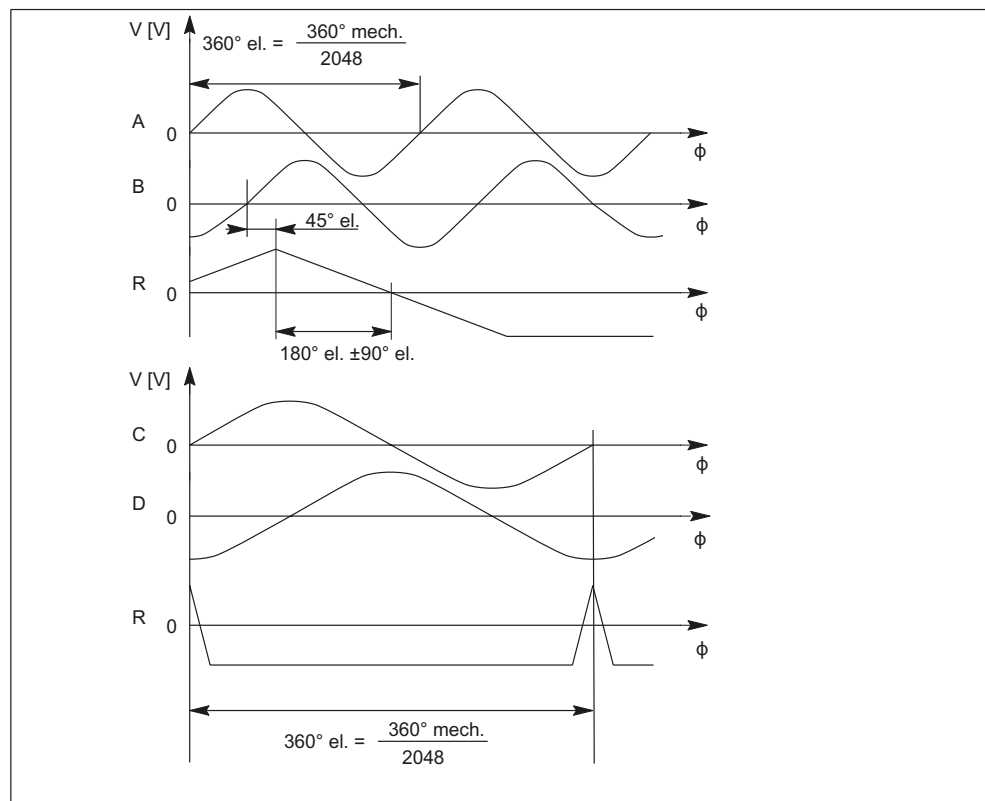
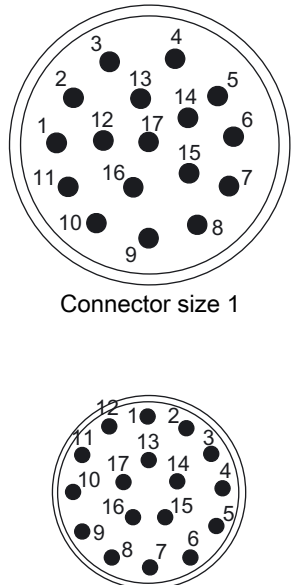

Figure 6-2 Signal sequence and assignment for a positive direction of rotation

Connection assignment for 17-pin flange-mounted socket with pin contacts

Table 6-5 Connection assignment, 17-pin flange-mounted socket

PIN No.	Description of the signals		When viewing the plug-in side (pins)
	Connector size 1 for 1FK702□ to 1FK710□	Connector size 0.5 for 1FK701□	
1	A	R	 <p>Connector size 1</p> <p>Connector size 0.5</p>
2	A*	R*	
3	R	B	
4	D*	B*	
5	C	A	
6	C*	A*	
7	M encoder	M encoder	
8	+1R1	P encoder	
9	-1R2	+1R1	
10	P encoder	-1R2	
11	B	0 V sense	
12	B*	5 V sense	
13	R*	not connected	
14	D	D*	
15	0 V sense	C	
16	5 V sense	C*	
17	not connected	D	

Cables

Table 6-6 Prefabricated cable

Connector size 0.5	6FX	5	002	-	2CA20	-	1□□	0
Connector size 1	6FX	□	002	-	2CA31	-	□□□	0
		↓					↓↓↓	
		↓					Length	
			5 MOTION-CONNECT®500				Max. cable length 100 m	
			8 MOTION-CONNECT®800				Max. cable length 100 m	

For other technical data and length code, refer to catalog, Chapter "MOTION-CONNECT connection system"

6.2.5 Absolute value encoder

Function:

- Angular measuring system for the commutation
- Speed actual value sensing
- Indirect absolute measuring system for the position control loop

Table 6-7 Technical data, absolute value encoder

Properties	Absolute encoders EnDat (A-2048)	Absolute encoders EnDat (A-512)	Simple absolute value encoder (A-32)
Mech. limiting speed	12000 RPM	12000 RPM	12000 RPM
Operating voltage	5 V \pm 5 %	5 V \pm 5 %	5 V \pm 5 %
Power consumption	max. 300 mA	max. 200 mA	max. 300 mA
Resolution, incremental (periods per revolution)	2048	512	32
Absolute resolution (coded revolutions)	4096	4096	4096
Incremental signals	1 Vpp	1 Vpp	1 Vpp
Serial absolute position interface	EnDat	EnDat	EnDat
Angular error	\pm 40"	\pm 80"	\pm 280"

Note

As a result of the reduced maximum operating temperature of absolute encoders with respect to incremental encoders, the thermally permissible rated motor torque is reduced by 10%.

Connection assignment for 17-pin flange-mounted socket with pin contacts

Table 6-8 Connection assignment, 17-pin flange-mounted socket

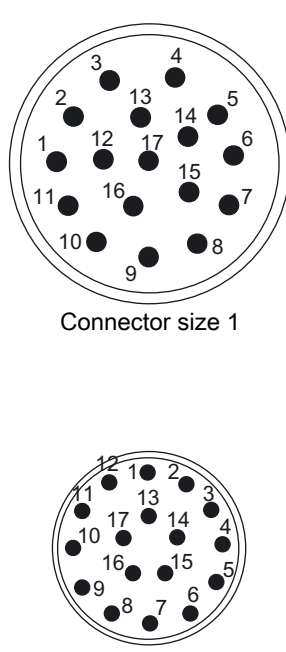
PIN No.	Description of the signals		When viewing the plug-in side (pins)
	Connector size 1 for 1FK702□ to 1FK710□	Connector size 0.5 for 1FK701□	
1	A	data	 <p>Connector size 1</p> <p>Connector size 0.5</p>
2	A*	data*	
3	data	B	
4	not connected	B*	
5	clock	A	
6	not connected	A*	
7	M encoder	M encoder	
8	+1R1	P encoder	
9	-1R2	+1R1	
10	P encoder	-1R2	
11	B	0 V sense	
12	B*	5 V sense	
13	data*	not connected	
14	clock*	clock	
15	0 V sense	not connected	
16	5 V sense	not connected	
17	not connected	clock*	

Cables

Table 6-9 Prefabricated cable

Connector size 0.5	6FX	5	002	-	2EQ20	-	1□□	0
Connector size 1	6FX	□	002	-	2EQ10	-	□□□	0
		↓					↓↓↓	
		↓					Length	
			5 MOTION-CONNECT®500				Max. cable length 100 m	
			8 MOTION-CONNECT®800				Max. cable length 100 m	

For other technical data and length code, refer to catalog, Chapter "MOTION-CONNECT connection system"

6.2.6 Resolvers

Function:

- Angular measuring system for the commutation
- Speed actual value sensing
- Indirect incremental measuring system for the position control loop

Table 6-10 Technical data, resolvers

Properties	Resolver
Mech. limiting speed	15 000 RPM
Excitation voltage	5 V (rms) to 13 V (rms)
Excitation frequency	4 kHz to 10 kHz
Power consumption	< 80 mA (rms)
Angular accuracy (bandwidth) 2-pole multi-pole (> 2)	< 14' < 4'
Number of poles, resolver Number of poles, resolver = number of poles, motor	2 4, 6, 8
Transformation ratio	0.5

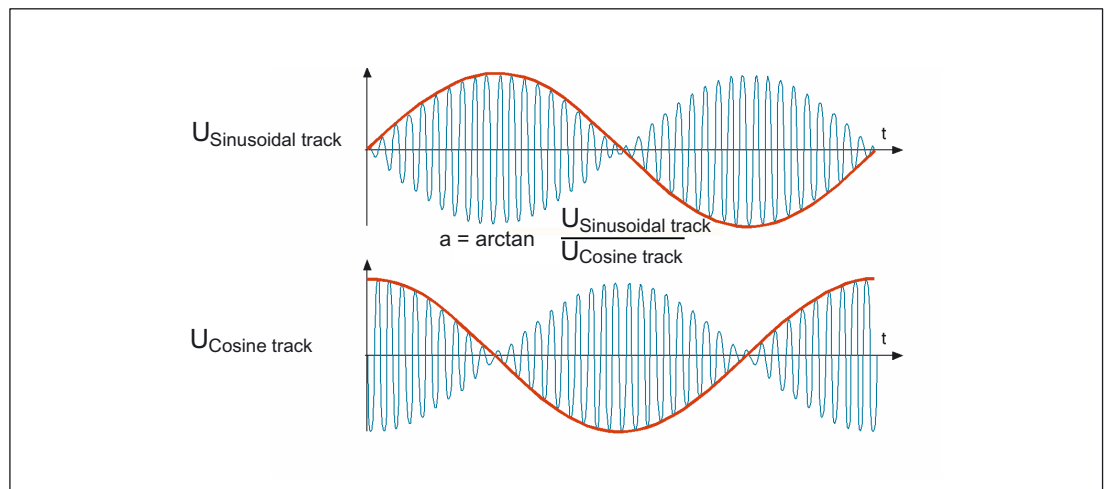
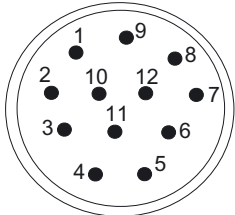
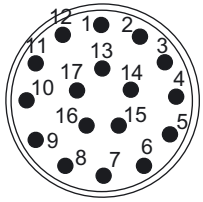

Figure 6-3 Output signals, resolver

Connection assignment for 12/17-pin flange socket with pin contacts

Table 6-11 Connection assignment for flange socket, 12-pin

PIN No.	Description of the signals		When viewing the plug-in side (pins)
	12-pin Connector size 1 for 1FK702□ to 1FK710□	17-pin Connector size 0.5 for 1FK701□	
1	S2	+1R1	 <p>Connector size 1</p>  <p>Connector size 0.5</p>
2	S4	-1R2	
3	not connected	not connected	
4	not connected	S1	
5	not connected	S3	
6	not connected	not connected	
7	R2	S2	
8	+1R1	S4	
9	-1R2	not connected	
10	R1	R1	
11	S1	R2	
12	S3	not connected	
13	---	not connected	
14	---	not connected	
15	---	not connected	
16	---	not connected	
17	---	not connected	

Cables

Table 6-12 Prefabricated cable

Connector size 0.5	6FX	5	002	-	2CF20	-	1□□	0
Connector size 1	6FX	□	002	-	2CF02	-	□□□	0
		↓					↓↓↓	
		↓					Length	
			5		MOTION-CONNECT®500		Max. cable length 130 m	
			8		MOTION-CONNECT®800		Max. cable length 50 m	

For other technical data and length code, refer to catalog, Chapter "MOTION-CONNECT connection system"

6.3 Holding brake (option)

6.3.1 Properties

- The integrated or mounted holding brake is used to clamp the motor shaft when the motor is at a standstill. The holding brake is **not** a working brake that is used to brake a motor that is still rotating.
- Restricted Emergency Stop operation is permissible. Up to 2000 braking operations can be executed with 300% rotor moment of inertia as external moment of inertia from a speed of 3000 RPM without the brake being subject to an inadmissible amount of wear. The specific highest switching work for each emergency braking operation may not be exceeded.
- The rated voltage of the holding brake is 24 VDC.



Caution

The rated voltage is 24 VDC +/- 10%. Voltages outside this tolerance bandwidth can result in faults.

Inadmissible wear means that the braking function can no longer be guaranteed! It is not permissible to exceed the above specified Emergency Stop conditions or to repeatedly briefly accelerate the motor against a holding brake that is still closed. This means that the switching times of the brakes and relays must be taken into account in the drive control and enable functions.

Notice

Motors with or without holding brake cannot be subsequently retrofitted!

Motors with holding brake are longer by the mounted space required (refer to the dimension drawings).

6.3.2 Brake types

Brakes with different principles of operation are used:

- Permanent-magnet brake
- Spring-operated brake

Both of the brake types operate according to the closed-circuit principle.

6.3.3 Permanent-magnet brake

Mode of operation of a permanent-magnet brake

The magnetic field of the permanent magnets results in a pulling force on the brake armature disk. This means that in the no-current condition, the brake is closed and the motor shaft is held.

When 24 VDC rated voltage is connected to the brake, the solenoid – through which current flows – establishes an opposing field. This neutralizes the force of the permanent magnets. Permanent magnet brakes have a proportionally stiff connection to the motor rotor. This is the reason that this brake is almost without any play.

Caution

Motors with integrated permanent-magnet holding brake cannot be subject to axial forces at the shaft end! This applies when installing the system and during operation.

6.3.4 Spring-operated brake

Mode of operation of a spring-operated brake

For a spring-operated brake, instead of the magnetic field of a permanent magnet, the force of a spring is used.

In order for a spring-operated brake to operate, the brake armature disk must be able to axially move. Therefore, torsional backlash cannot be avoided. When the brake is closed, the motor shaft can move by up to 1°.

Effect on vertical axes:

The motor brakes a vertical axis electrically. If the brake is applied and the power is then disconnected, it is possible that the load could continue to move the motor shaft. In this case, the maximum possible motion corresponds to the above mentioned play in the gear meshing. The motion is appropriately stepped-up or stepped-down using a mounted gearbox.



Danger

The use of holding brakes with vertical axes must be carefully considered as a high danger potential exists.

For motors with a spring-operated brake, the suitability of the brake based on the rotational play must be verified.

For motors with spring-operated brakes, axial forces are permissible the same as for versions without brake.

6.3.5 Protective circuitry for the brake

Caution

In order to avoid overvoltages when shutting down and the possible negative impact on the plant or system environment, a protective circuit must be integrated into the brake feeder cable (refer to Fig. "Recommended circuit for the external power supply with protective circuit").

If protective circuitry is not used, voltage peaks over 1000 V can occur in the millisecond range. Brake solenoid, switching contacts and electronic components could be destroyed.

Sensitive electronic components (e.g. logic components) can even be damaged as a result of a lower switch-off voltage. The power limits (e.g. ratings) of the components used should be carefully observed.

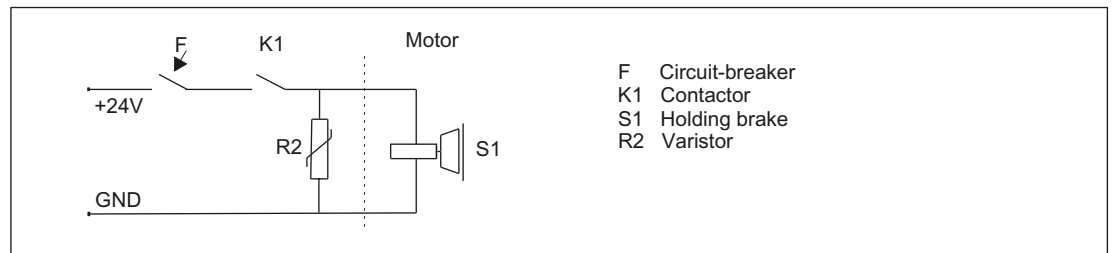

Figure 6-4 Recommended circuit for the external power supply with protective circuit

Table 6-13 Example Electronic components for the recommended circuit

Electr. component	Examples		
F	3RV10 circuit-breaker with current paths connected in series (if required with mounted auxiliary contact 3RV1901 to provide a feedback signal for the drive).	or	Miniature circuit-breaker 5SX21 (if required with mounted auxiliary contact to provide a feedback signal for the drive).
K1	Auxiliary contactor 3RH11	or	Contactor 3RT10
R2	Varistor SIOVS14K30 (EPCOS)		

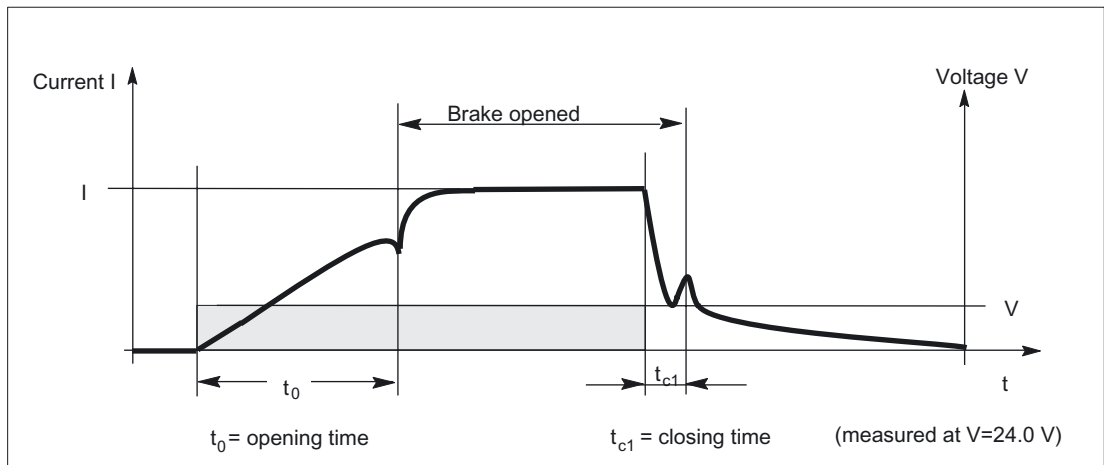

Figure 6-5 Terminology (time) for holding operation

Important information and instructions when installing the connecting cable

The brake connecting cable is included in the power cable. The insulation between the power and brake connection is dimensioned for basic insulation (VDE 600 V/1000 V UL). The relay K1, located between the coil and contact, must also have basic insulation in order to protect the internal logic voltage (PELV=Protective Extra Low Voltage). The PELV supply may not be used to supply the holding brake (refer to Fig. "Recommended circuit for the external power supply with protective circuit").

Determining the minimum voltage

The minimum voltage of 24 VDC -10% must be available at the connector on the motor side in order to guarantee that the brake reliably opens. If the maximum voltage of 24 VDC +10% is exceeded, then the brake could re-close. The voltage drop along the brake feeder cable must be taken into consideration.

The voltage drop ΔU for copper cables can be approximately calculated as follows:

$$\Delta U [V] = 0.042 \cdot (l/q) \cdot I_{\text{Brake}}$$

l = Cable length [m]
 q = Brake core cross section [mm²]
 I_{Brake} = DC current of brake [A]

6.3.6 Technical data of the holding brake

Table 6-14 Technical data of the holding brakes used for 1FK7 motors

Motor type	Brake type	Holding torque at 120 °C M_4	Direct current at 20 °C	Opening time with varistor	Closing time with varistor	Highest switched energy
		[Nm]	[A]	[ms]	[ms]	[J]
1FK7 CT permanent-magnet brakes						
1FK701□	HT03P	0,4	0,3	30	20	2
1FK7022	EBD 0.11 BN	1,0	0,3	30	20	8
1FK703□	EBD 0.13 BN	1,3	0,4	50	30	17
1FK704□	EBD 0.3 BV	3,2	0,6	70	30	74
1FK706□	EBD 0.8 BK	13	0,8	100	50	400
1FK7080	EBD 1.5 BN	10	0,7	100	50	400
1FK7083 1FK7100	EBD 2 BY	22	0,9	200	60	1400
1FK7101 1FK7103 1FK7105	EBD 3.5 BV	41	1,0	300	70	3000
1FK7 HD spring-operated brakes						
1FK7033	1EB 14-30	1,3	0,5	100	40	14
1FK704□	1EB 20-40	4	0,6	150	50	96
1FK706□	1EB 28-60	12	0,8	150	50	230
1FK708□	1EB 35-80	22	1,2	200	60	700

Holding torque M_4

The holding torque M_4 is the highest permissible torque with which the closed brake can be loaded in steady-state operation without slip (holding function when motor is stationary).

6.4 Brake resistances (armature short-circuit braking)

6.4.1 Function description

For transistor PWM converters, when the DC link voltage values are exceeded or if the electronics fails, then electrical braking is no longer possible. If the drive which is coasting down, can represent a potential hazard, then the motor can be braked by short-circuiting the armature. Armature short-circuit braking should be initiated at the latest by the limit switch in the traversing range of the feed axis.

The friction of the mechanical system and the switching times of the contactors must be taken into account when determining the distance that the feed axis takes to come to a complete stop. In order to avoid mechanical damage, mechanical stops should be located at the end of the absolute traversing range.

For servomotors with integrated holding brake, the holding brake can be simultaneously applied to create an additional braking torque – however, with some delay.

Caution

The drive converter pulses must first be canceled and this actually implemented before an armature short-circuit contactor is closed or opened. This prevents the contactor contacts from burning and eroding and destroying the drive converter.



Warning

The drive must always be operationally braked using the setpoint input. For additional information, refer to the Drive Converter Configuration Manual.

The optimum braking torque of the servomotor in regenerative operation can be obtained using armature short-circuit with a matching external resistor circuit.

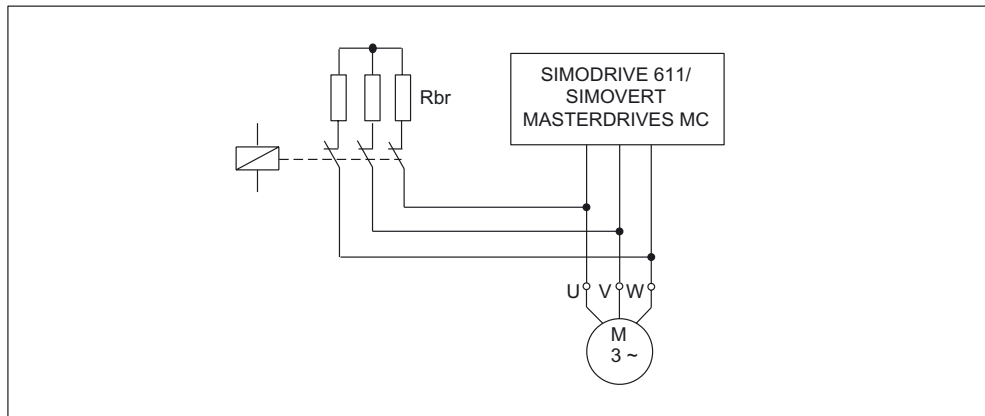

Figure 6-6 Circuit (schematic) with brake resistors

Ordering address

Frizlen GmbH & Co. KG
 Gottlieb-Daimler-Str. 61, 71711 Murr
 Germany

Phone: +49 (0) 7144 / 8100 - 0

Fax: +40 (0) 7144 / 2076 - 30

E-mail: info@frizlen.com

Internet at: www.frizlen.com

Note

We cannot accept any liability for the quality and properties/features of third-party products.

6.4.2 Rating

The ratings of the resistors must match the particular I²t load capability. The resistor can be dimensioned so that a surface temperature of 300 °C can occur briefly (max. 500 ms). In order to prevent the resistor from being destroyed, braking from the rated speed can occur max. every 2 minutes. Other braking cycles must be specified when ordering the resistors. The external moment of inertia and the intrinsic motor moment of inertia are decisive when dimensioning these resistors.

The kinetic energy must be specified when ordering in order to determine the resistor rating.

$$W = \frac{1}{2} \cdot J \cdot \omega^2$$

W	[Ws]
J	[kgm ²]
ω	[s ⁻¹]

6.4.3 Braking time and deceleration distance

The braking time is calculated using the following formula:

Braking time:

$$t_B = \frac{J_{\text{tot}} \cdot n_N}{9.55 \cdot M_B}$$

Braking time t_B [s]

Rated speed n_N [RPM]

Moment of inertia:

$$J_{\text{tot}} = J_{\text{mot}} + J_{\text{ext}}$$

Average braking torque M_B [Nm]

Moment of inertia J [kgm²]

Braking distance:

$$s = \frac{1}{2} V_{\text{max}} \cdot t_B$$

Braking distance s [m]

Velocity V_{max} [m/s]

Notice

When determining the run-on distance, then, for example, the friction (taken into account as allowance in M_B) of the mechanical transmission elements and the switching delay times of the contactors must be taken into consideration. In order to prevent mechanical damage, mechanical end stops should be provided at the end of the absolute traversing range of the machine axes.

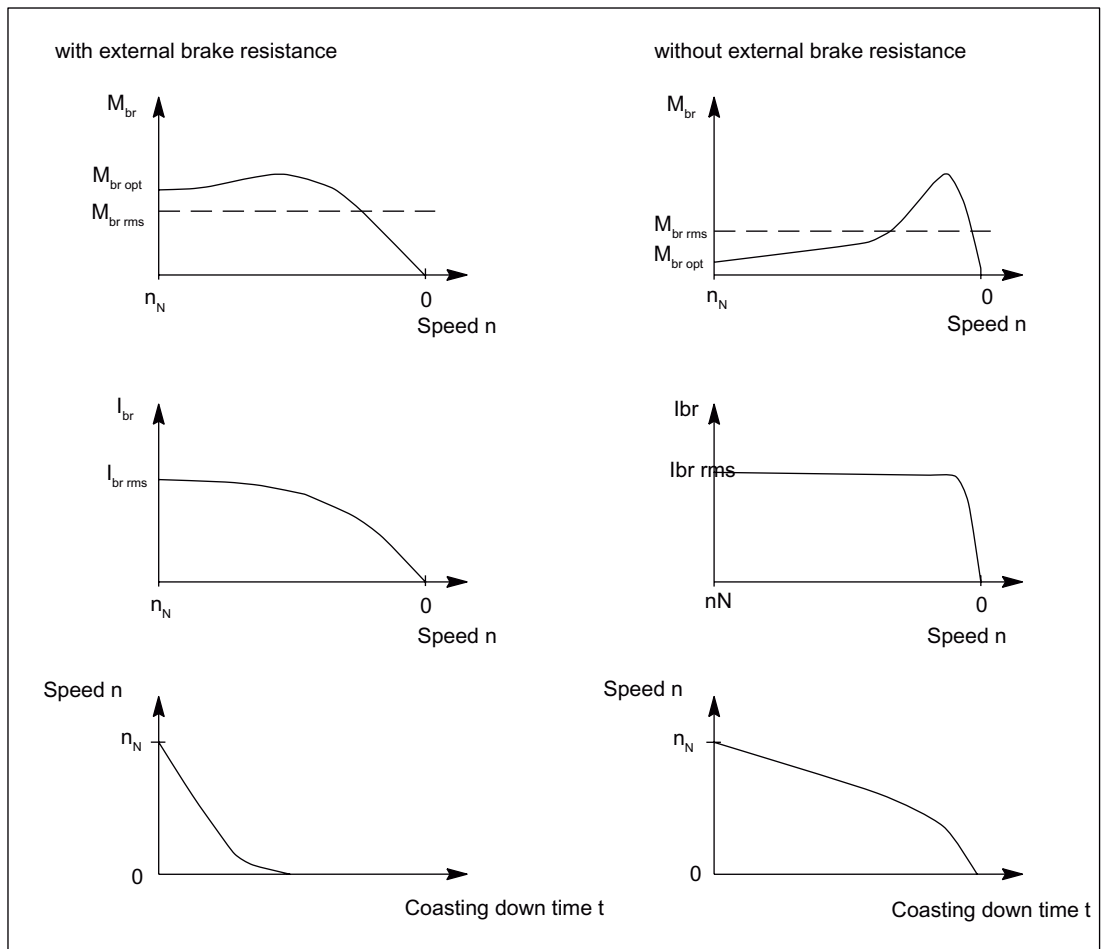

Figure 6-7 Armature short-circuit braking

6.4.4 Dimensioning of braking resistors

The correct dimensioning ensures an optimum braking time. The braking torques which are obtained are also listed in the tables. These data apply to braking operations from the rated speed and moment of inertia $J_{\text{external}} = J_{\text{mot}}$. If the drive is braked from another speed, then the braking time cannot be proportionally reduced. However, longer braking times cannot occur if the speed at the start of braking is less than the rated speed.

The data in the following table is calculated for rated values according to the data sheet. The variance during production as well as iron saturation have not been taken into account here. Higher currents and torques can occur than those calculated as a result of the saturation.

Table 6-15 Dynamic braking for 1FK7 CT

Motor type	Braking resistor, external R_{opt} [Ω]	Average braking torque $M_{\text{br rms}}$ [Nm]		Max. braking torque $M_{\text{br max}}$ [Nm]	RMS braking current $I_{\text{br rms}}$ [A]	
		Without external braking resistor	With external braking resistor		Without external braking resistor	With external braking resistor
1FK7011-5AK71	2.3	0.13	0.14	0.17	2.5	2.3
1FK7015-5AK71	6.2	0.23	0.28	0.35	2.6	2.3
1FK7022-5AK71	4.1	1.0	1.2	1.5	5.9	5.4
1FK7032-5AK71	15.7	0.7	1.1	1.4	3.7	3.4
1FK7034-5AK71	12.7	1.3	2.0	2.5	5.5	4.9
1FK7040-5AK71	20.1	0.4	0.9	1.1	3.2	2.9
1FK7042-5AF71	16.4	1.3	2.2	2.7	3.6	3.2
1FK7042-5AK71	9.0	0.9	2.2	2.7	7.5	6.7
1FK7060-5AF71	8.8	1.8	4.0	5.0	7.2	6.4
1FK7060-5AH71	6.9	1.5	4.1	5.2	10.3	9.2
1FK7063-5AF71	4.8	3.3	8.2	10.2	14.0	12.5
1FK7063-5AH71	3.4	2.5	7.9	9.8	20.5	18.3
1FK7080-5AF71	10.0	2.0	5.5	6.8	8.1	7.2
1FK7080-5AH71	6.7	1.5	5.6	6.9	12.3	11.0
1FK7083-5AF71	3.6	4.9	13.7	17.0	21.2	19.0
1FK7083-5AH71	3.0	2.8	12.5	15.5	28.0	25.0
1FK7100-5AF71	4.1	4.1	13.2	16.4	19.6	17.5
1FK7101-5AF71	2.1	5.6	20.6	25.7	34.4	30.8
1FK7103-5AF71	1.4	7.3	28.3	35.1	49.4	44.2
1FK7105-5AC71	1.8	15.2	44.5	55.3	44.2	39.6
1FK7105-5AF71	1.2	11.9	45.9	57.0	68.9	61.6

6.4 Brake resistances (armature short-circuit braking)

Table 6-16 Dynamic braking for 1FK7 HD

Motor type	Braking resistor, external R_{opt} [Ω]	Average braking torque $M_{br\ rms}$ [Nm]		Max. braking torque $M_{br\ max}$ [Nm]	RMS braking current $I_{br\ rms}$ [A]	
		Without external braking resistor	With external braking resistor		Without external braking resistor	With external braking resistor
1FK7033-7AK71	16.7	0.5	0.9	1.1	3.4	3.1
1FK7043-7AH71	10.7	0.5	1.4	1.8	4.8	4.3
1FK7043-7AK71	7.9	0.4	1.4	1.7	6.5	5.8
1FK7044-7AF71	8.5	0.9	1.9	2.3	4.9	4.4
1FK7044-7AH71	7.2	0.7	1.9	2.4	6.8	6.1
1FK7061-7AF71	8.5	0.9	2.7	3.4	6.2	5.6
1FK7061-7AH71	6.4	0.6	2.7	3.4	8.9	8.0
1FK7064-7AF71	5.1	1.3	4.9	6.1	10.9	9.7
1FK7064-7AH71	3.8	1.1	5.7	7.1	16.7	15.0
1FK7085-7AF71	2.3	2.2	9.6	11.9	22.8	20.4
1FK7086-7AF71	1.9	5.4	20.7	25.7	36.6	32.7

Table 6-17 Dynamic braking for 1FK7 CT/HD on Power Module 1 AC 230 V

Motor type	Braking resistor, external R_{opt} [Ω]	Average braking torque $M_{br\ rms}$ [Nm]		Max. braking torque $M_{br\ max}$ [Nm]	RMS braking current $I_{br\ rms}$ [A]	
		Without external braking resistor	With external braking resistor		Without external braking resistor	With external braking resistor
1FK7011-5AK21	6.9	0.13	0.14	0.17	1.4	1.3
1FK7015-5AK21	19.1	0.23	0.28	0.34	1.5	1.3
1FK7022-5AK21	4.4	1.0	1.1	1.4	5.7	5.2
1FK7032-5AF21	3.5	1.2	1.3	1.7	4.3	4.0
1FK7033-7AF21	4.8	0.9	1.1	1.4	4.0	3.7
1FK7034-5AF21	3.3	2.1	2.2	2.8	5.9	5.5
1FK7042-5AF21	3.6	1.9	2.8	3.4	8.4	7.6
1FK7043-7AF21	5.9	0.8	1.6	2.0	5.4	4.8

6.5 Drive coupling

6.5.1 Function description

Function description

After investigating various drive-out couplings for servomotors in conjunction with Siemens drive converters, it was seen, that in many cases, the drive-out couplings were the cause of vibration problems. In order to achieve optimum drive-out characteristics, ROTEX® GS couplings supplied by KTR should be used. The advantages of ROTEX® GS couplings include:

- 2 to 4x torsional stiffness of a belt-driven gearbox
- No intermeshing teeth (when compared to belt gearboxes)
- Low moment of inertia
- Good control behavior

When it comes to mounting, the clamping hub without key is considered to be adequate up to a coupling size of 38 and up to the specified torques that can be transferred. The friction torques must always be adequately dimensioned depending on how they are assigned to individual motor frame sizes. The accelerating torque also has to be transferred.

From a coupling size of 42 or as an alternative to the clamping hub, we can recommend the version with clamping ring hub. This means that the maximum coupling torque can be almost reached.

The investigations extend to include the vibration characteristics and behavior. The couplings assigned to the motors permit higher speed control loop gains and therefore result in the highest possible K_V values and uniform motion.

ROTEX® GS couplings are available with 4 different plastic pinion gears with various Shore hardnesses:

98 or 95 Shore A (average)

Alternatively: 92 Shore A

Alternatively: 80 Shore A (soft)

Alternatively: 64 Shore D (hard)

The adaptation to the existing machine masses and stiffness, which becomes possible, must be determined, taking into account the mounted mechanical system.

Ordering address

Address:	KTR Kupplungstechnik GmbH Rodder Damm 170, D - 48432 Rheine
Postal address:	Postfach 1763, D - 48407 Rheine
Phone:	+49 (0) 5971 / 798 - 465 (337)
Fax:	+49 (0) 5971 / 798 - 450
Internet at:	www.ktr.com

6.5.2 Technical data for the couplings

Table 6-18 Assignment of the drive couplings to the motors

Motor 1FK7	d_w [mm] ¹⁾	Rotex® GS Type	Transferable torques with 80 or 92 Sh A pinion		T_R [Nm] ⁴⁾
			T_{KN} [Nm] ²⁾	T_{Kmax} [Nm] ³⁾	
1FK7022-...	9	9	1.8	3.6	2.6
1FK703□-...	14	14	7.5	15	102
1FK704□-...	19	19/24	10	20	-
1FK706□-...	24	24/28	35	70	-
1FK708□-...	32	28/38	95	190	-
1FK710□-...	38	38/45	190	380	-

- 1) d_w = diameter, motor shaft end
- 2) T_{KN} = rated coupling torque
- 3) T_{Kmax} = maximum coupling torque
- 4) T_R = friction-locking torque (transferable torque with clamping hub for d_w)

It may be necessary to use other gear rings (e.g. Shore hardness 80 Sh A). They must be optimally harmonized with the mounted mechanical system.

Notice

We cannot accept any liability for the quality and properties/features of third-party products.

Technical data and characteristics

7.1 Introduction

The rating data specified in the tables refer to $V_{\text{supply rms}} = 400 \text{ V}$, Active Line Module, characteristic [b].

Note

The voltage limiting characteristics [a], [b], [c] refer to the converter output voltage as a function of the supply voltage.

Supply voltage:

230 V 1 AC
400 V 3 AC
480 V 3 AC

Note

The specified thermal S3 limiting characteristics are referred to $\Delta T = 100 \text{ K}$ for

- 1 min. cycle duration with 1FK701□ to 1FK703□
 - 10 min. cycle duration with 1FK704□ to 1FK710□
-

7.2 1FK7 motors on SINAMICS S120 with 3 AC 400/480 V power supply

7.2.1 1FK7 Compact

Table 7-1 1FK7011 CT

Technical data	Code	Units	-5AK71	
Configuration data				
Rated speed	n _N	RPM	6000	
No. of poles	2p		8	
Rated torque (100 K)	M _N (100 K)	Nm	0.08	
Rated current (100 K)	I _N	A	0.85	
Static torque (60 K)	M _{l0} (60 K)	Nm	0.15	
Static torque (100 K)	M _{l0} (100 K)	Nm	0.18	
Stall current (60 K)	I _{l0} (60 K)	A	1.2	
Stall current (100 K)	I _{l0} (100 K)	A	1.5	
Moment of inertia (with brake)	J _{MotBr}	10 ⁻⁴ kgm ²	0.083	
Moment of inertia (without brake)	J _{Mot}	10 ⁻⁴ kgm ²	0.064	
Optimum operating point				
Optimum speed	n _{opt}	RPM	5000	
Optimum power	P _{opt}	kW	0.06	
Limiting data				
Max. permissible speed (mech.)	n _{max mech}	RPM	8000	
Max. permissible speed (converter)	n _{max Inv}	RPM	8000	
Max. torque	M _{max}	Nm	0.5	
Max. current	I _{max}	A	4.2	
Physical constants				
Torque constant	k _T	Nm/A	0.12	
Voltage constant	k _E	V/1000 RPM	8	
Winding resistance at 20°C	R _{Str}	Ohm	3	
Cyclic inductance	L _D	mH	4.2	
Electrical time constant	T _{el}	ms	1.4	
Mechanical time constant	T _{mech}	ms	4	
Thermal time constant	T _{th}	min	14	
Shaft torsional stiffness	C _t	Nm/rad	1400	
Weight with brake	m _{MotBr}	kg	1.0	
Weight without brake	m _{Mot}	kg	0.9	
Recommended motor module 6SL312_-TE13-0AA_				
Rated current converter	I _{N Inv}	A	3	
Max. current converter	I _{max Inv}	A	6	
Max. torque at I _{max Inv}	M _{max Inv}	Nm	0.5	

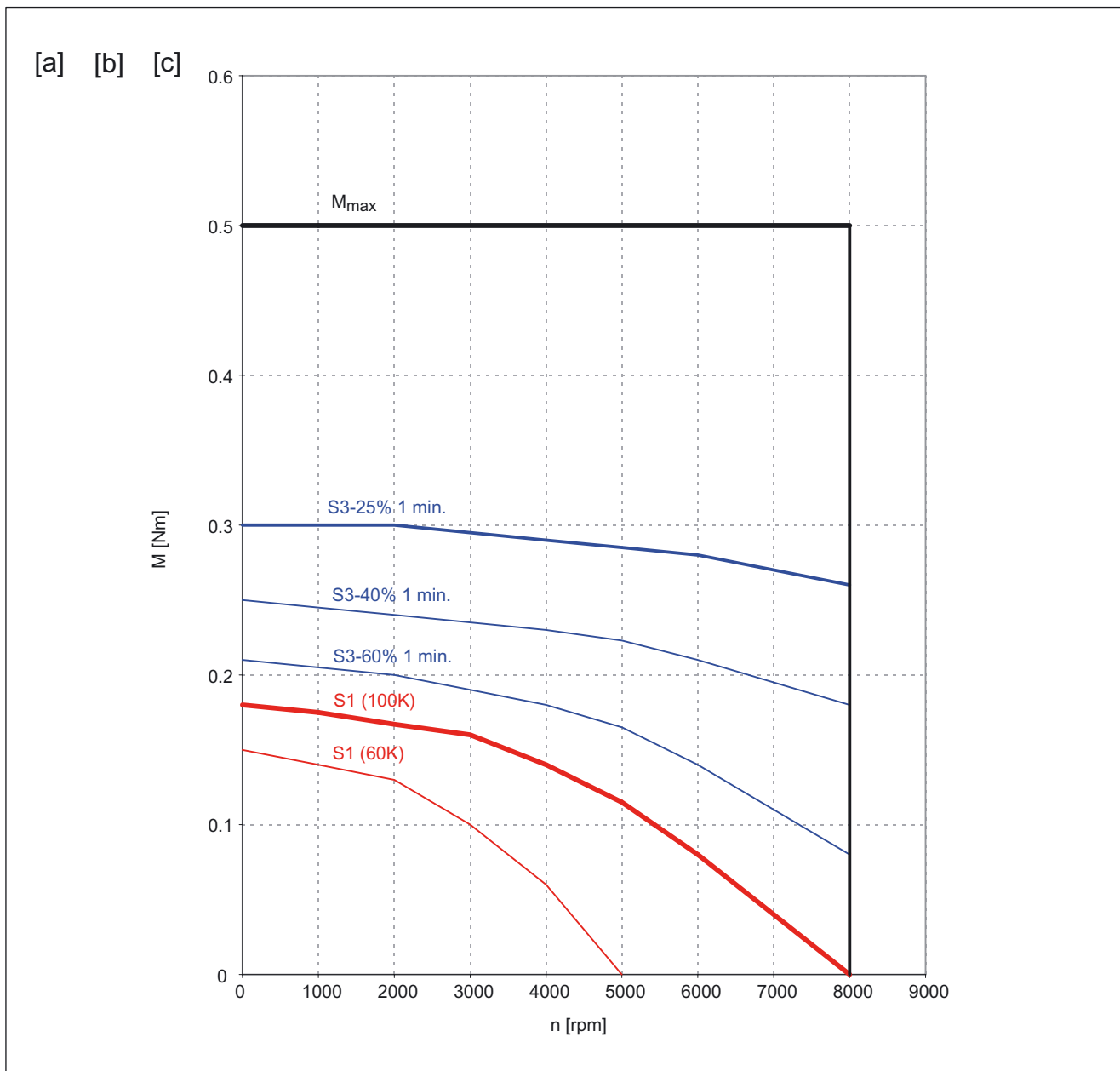

Figure 7-1 1FK7011-5AK71

- [a] SINAMICS SLM 400 V
- [b] SINAMICS ALM 400 V
- [c] SINAMICS SLM 480 V

Table 7-2 1FK7015 CT

Technical data	Code	Unit	-5AK71	
Configuration data				
Rated speed	n_N	RPM	6000	
No. of poles	2p		8	
Rated torque (100 K)	M_N (100 K)	Nm	0.16	
Rated current (100 K)	I_N	A	0.85	
Static torque (60 K)	M_0 (60 K)	Nm	0.29	
Static torque (100 K)	M_0 (100 K)	Nm	0.35	
Stall current (60 K)	I_0 (60 K)	A	1.2	
Stall current (100 K)	I_0 (100 K)	A	1.5	
Moment of inertia (with brake)	J_{MotBr}	10^{-4} kgm ²	0.102	
Moment of inertia (without brake)	J_{Mot}	10^{-4} kgm ²	0.083	
Optimum operating point				
Optimum speed	n_{opt}	RPM	5000	
Optimum power	P_{opt}	kW	0.12	
Limiting data				
Max. permissible speed (mech.)	$n_{max\ mech}$	RPM	8000	
Max. permissible speed (converter)	$n_{max\ Inv}$	RPM	8000	
Max. torque	M_{max}	Nm	1	
Max. current	I_{max}	A	4.2	
Physical constants				
Torque constant	k_T	Nm/A	0.24	
Voltage constant	k_E	V/1000 RPM	16	
Winding resistance at 20°C	R_{Str}	Ohm	4.3	
Cyclic inductance	L_D	mH	8.4	
Electrical time constant	T_{el}	ms	2	
Mechanical time constant	T_{mech}	ms	1.9	
Thermal time constant	T_{th}	min	16	
Shaft torsional stiffness	C_t	Nm/rad	1300	
Weight with brake	m_{MotBr}	kg	1.2	
Weight without brake	m_{Mot}	kg	1.1	
Recommended motor module 6SL312_-TE13-0AA_				
Rated current converter	$I_N\ Inv$	A	3	
Max. current converter	$I_{max\ Inv}$	A	6	
Max. torque at $I_{max\ Inv}$	$M_{max\ Inv}$	Nm	1	

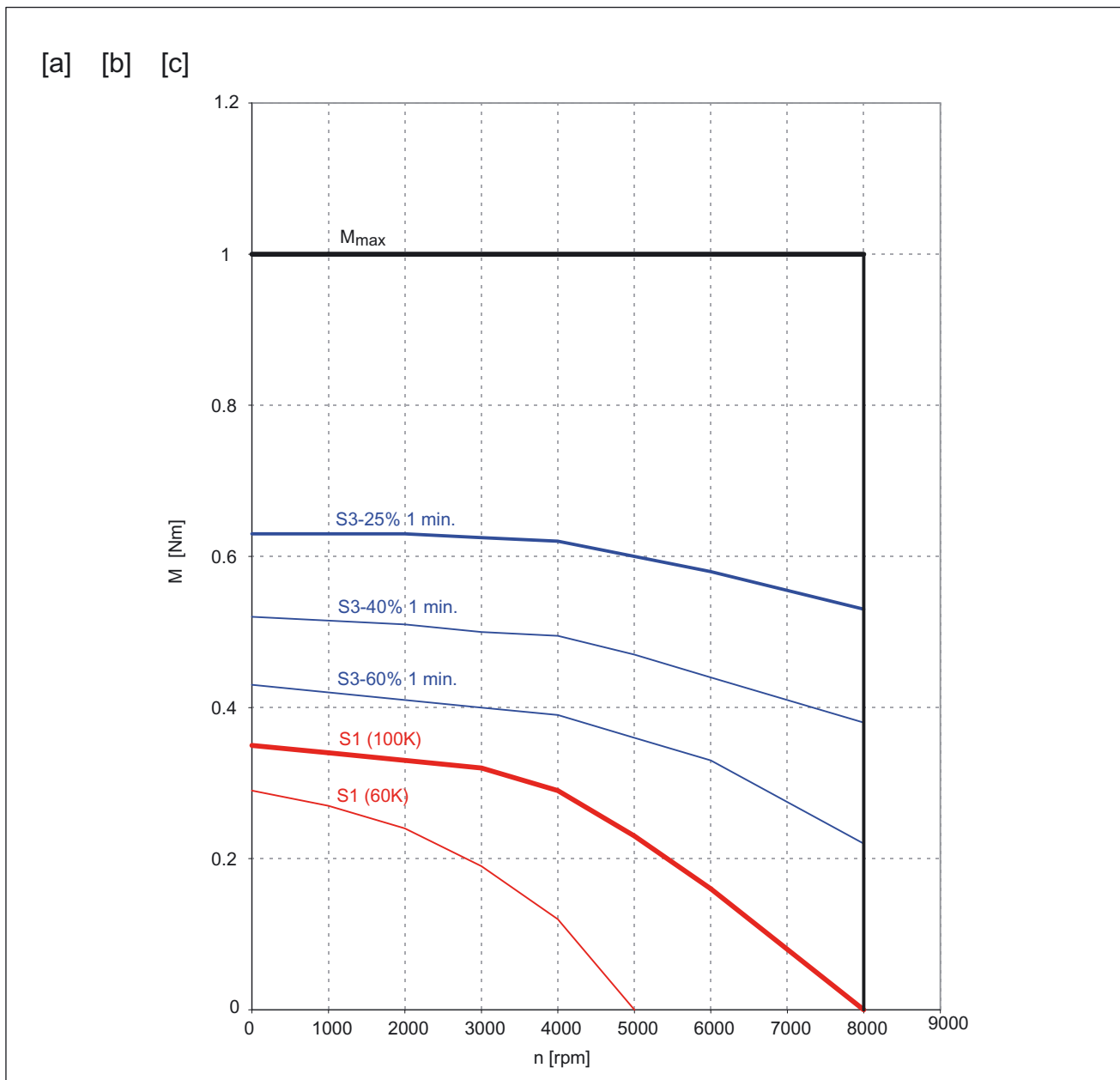

Figure 7-2 1FK7015-5AK71

- [a] SINAMICS SLM 400 V
- [b] SINAMICS ALM 400 V
- [c] SINAMICS SLM 480 V

Table 7-3 1FK7022 CT

Technical data	Code	Unit	-5AK71	
Configuration data				
Rated speed	n_N	RPM	6000	
No. of poles	2p		6	
Rated torque (100 K)	M_N (100 K)	Nm	0.6	
Rated current (100 K)	I_N	A	1.4	
Static torque (60 K)	M_0 (60 K)	Nm	0.7	
Static torque (100 K)	M_0 (100 K)	Nm	0.85	
Stall current (60 K)	I_0 (60 K)	A	1.5	
Stall current (100 K)	I_0 (100 K)	A	1.8	
Moment of inertia (with brake)	J_{MotBr}	10^{-4} kgm ²	0.35	
Moment of inertia (without brake)	J_{Mot}	10^{-4} kgm ²	0.28	
Optimum operating point				
Optimum speed	n_{opt}	RPM	6000	
Optimum power	P_{opt}	kW	0.38	
Limiting data				
Max. permissible speed (mech.)	$n_{max\ mech}$	RPM	10000	
Max. permissible speed (converter)	$n_{max\ Inv}$	RPM	10000	
Max. torque	M_{max}	Nm	3.4	
Max. current	I_{max}	A	8	
Physical constants				
Torque constant	k_T	Nm/A	0.46	
Voltage constant	k_E	V/1000 RPM	29	
Winding resistance at 20°C	R_{Str}	Ohm	4.2	
Cyclic inductance	L_D	mH	9.1	
Electrical time constant	T_{el}	ms	2.2	
Mechanical time constant	T_{mech}	ms	1.7	
Thermal time constant	T_{th}	min	18	
Shaft torsional stiffness	C_t	Nm/rad	3000	
Weight with brake	m_{MotBr}	kg	2.0	
Weight without brake	m_{Mot}	kg	1.8	
Recommended motor module 6SL312_-TE13-0AA_				
Rated current converter	$I_N\ Inv$	A	3	
Max. current converter	$I_{max\ Inv}$	A	6	
Max. torque at $I_{max\ Inv}$	$M_{max\ Inv}$	Nm	2.75	

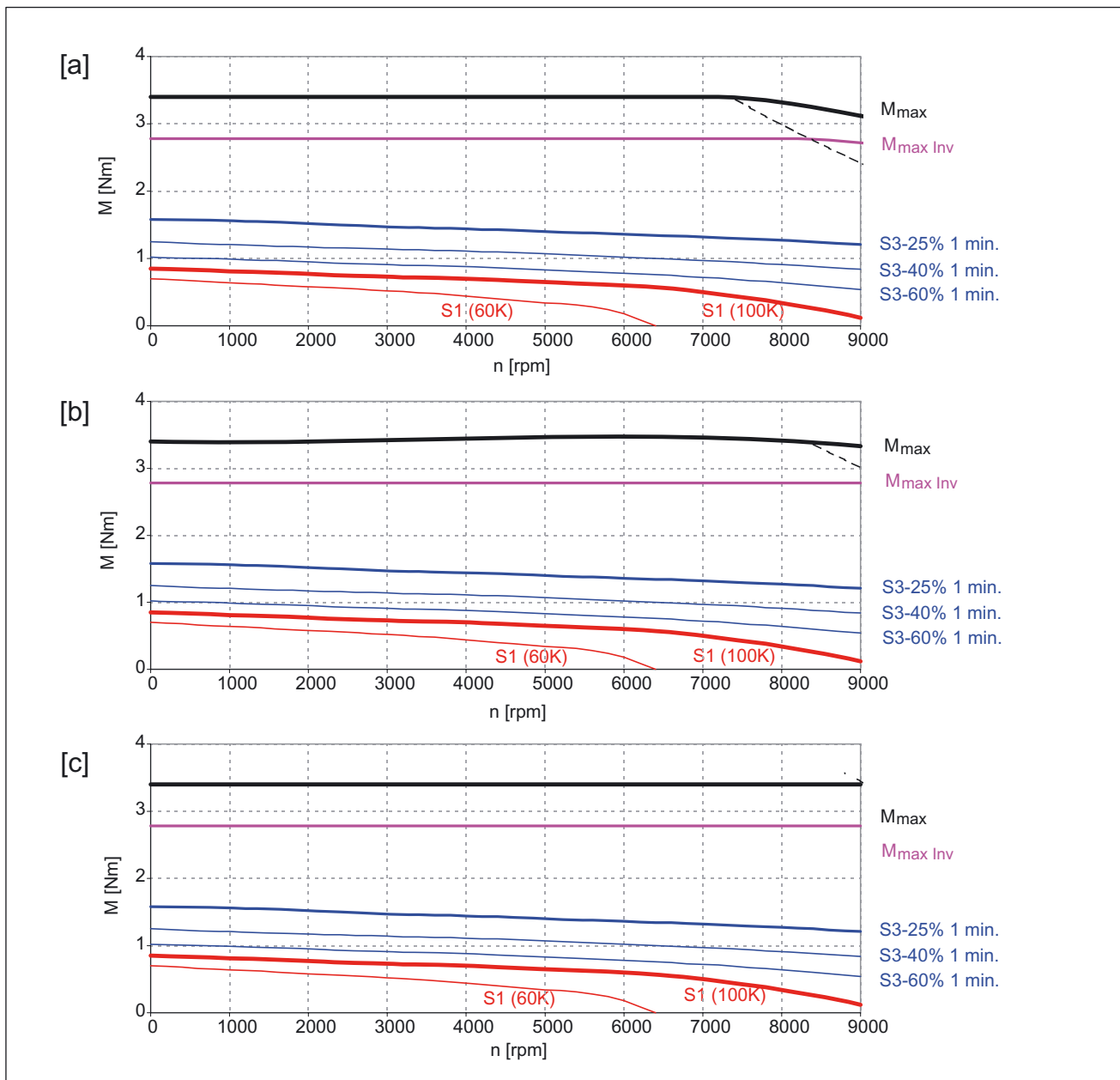

Figure 7-3 1FK7022 - 5AK71

- [a] SINAMICS SLM 400 V
- [b] SINAMICS ALM 400 V
- [c] SINAMICS SLM 480 V

Table 7-4 1FK7032 CT

Technical data	Code	Unit	-5AK71	
Configuration data				
Rated speed	n_N	RPM	6000	
No. of poles	2p		6	
Rated torque (100 K)	M_N (100 K)	Nm	0.8	
Rated current (100 K)	I_N	A	1.3	
Static torque (60 K)	M_0 (60 K)	Nm	0.85	
Static torque (100 K)	M_0 (100 K)	Nm	1.15	
Stall current (60 K)	I_0 (60 K)	A	1.4	
Stall current (100 K)	I_0 (100 K)	A	1.7	
Moment of inertia (with brake)	J_{MotBr}	10^{-4} kgm ²	0.69	
Moment of inertia (without brake)	J_{Mot}	10^{-4} kgm ²	0.61	
Optimum operating point				
Optimum speed	n_{opt}	RPM	6000	
Optimum power	P_{opt}	kW	0.5	
Limiting data				
Max. permissible speed (mech.)	$n_{max\ mech}$	RPM	10000	
Max. permissible speed (converter)	$n_{max\ Inv}$	RPM	10000	
Max. torque	M_{max}	Nm	4.5	
Max. current	I_{max}	A	7.5	
Physical constants				
Torque constant	k_T	Nm/A	0.67	
Voltage constant	k_E	V/1000 RPM	45	
Winding resistance at 20°C	R_{Str}	Ohm	5.2	
Cyclic inductance	L_D	mH	18.5	
Electrical time constant	T_{el}	ms	3.6	
Mechanical time constant	T_{mech}	ms	2.2	
Thermal time constant	T_{th}	min	25	
Shaft torsional stiffness	C_t	Nm/rad	6500	
Weight with brake	m_{MotBr}	kg	3.0	
Weight without brake	m_{Mot}	kg	2.7	
Recommended motor module 6SL312_-TE13-0AA_				
Rated current converter	$I_N\ Inv$	A	3	
Max. current converter	$I_{max\ Inv}$	A	6	
Max. torque at $I_{max\ Inv}$	$M_{max\ Inv}$	Nm	3.9	

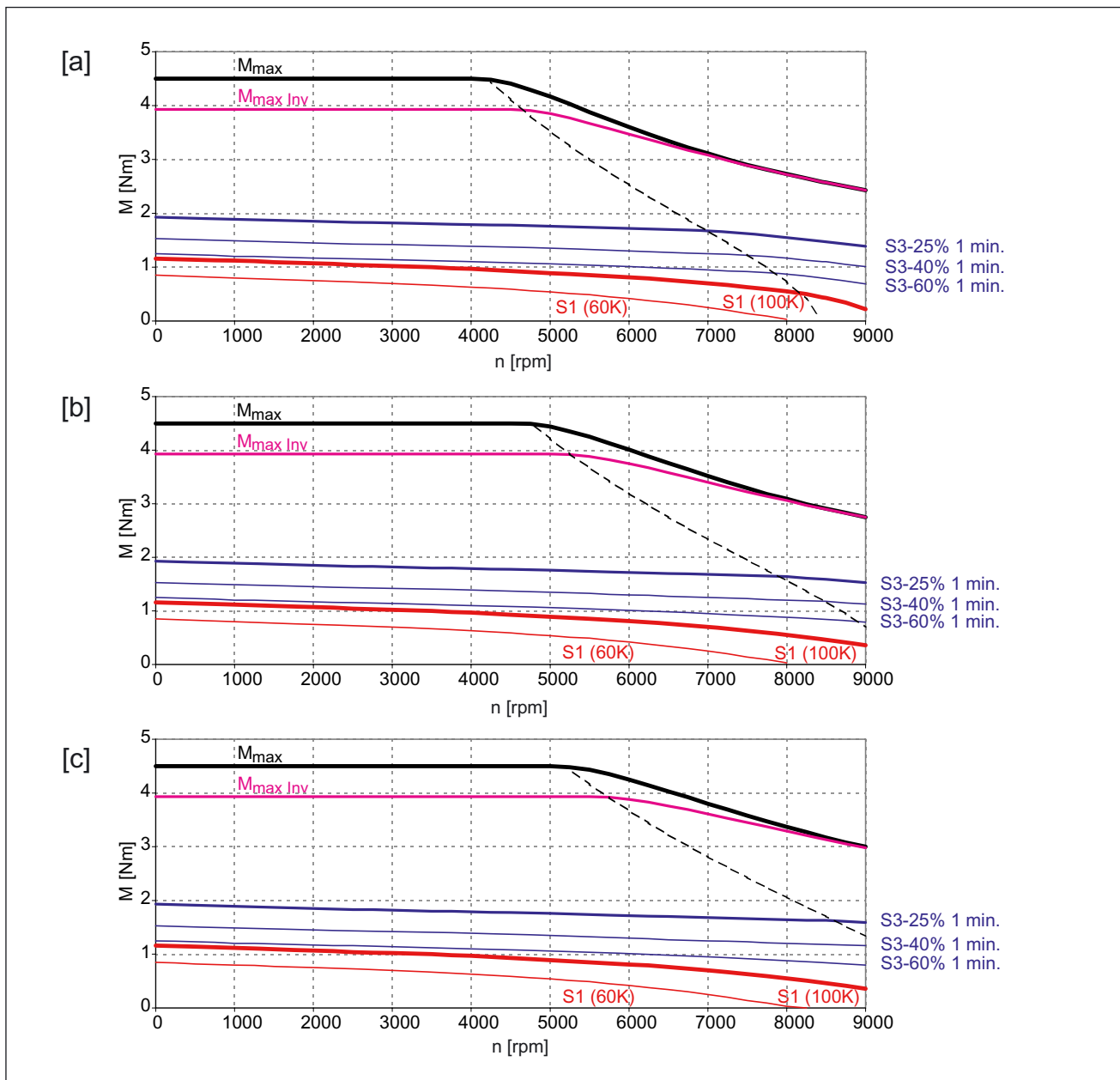

Figure 7-4 1FK7032-5AK71

- [a] SINAMICS SLM 400 V
- [b] SINAMICS ALM 400 V
- [c] SINAMICS SLM 480 V

Table 7-5 1FK7034 CT

Technical data	Code	Unit	-5AK71	
Configuration data				
Rated speed	n_N	RPM	6000	
No. of poles	2p		6	
Rated torque (100 K)	M_N (100 K)	Nm	1.0	
Rated current (100 K)	I_N	A	1.3	
Static torque (60 K)	M_0 (60 K)	Nm	1.35	
Static torque (100 K)	M_0 (100 K)	Nm	1.6	
Stall current (60 K)	I_0 (60 K)	A	1.6	
Stall current (100 K)	I_0 (100 K)	A	1.9	
Moment of inertia (with brake)	J_{MotBr}	10^{-4} kgm ²	0.98	
Moment of inertia (without brake)	J_{Mot}	10^{-4} kgm ²	0.9	
Optimum operating point				
Optimum speed	n_{opt}	RPM	6000	
Optimum power	P_{opt}	kW	0.63	
Limiting data				
Max. permissible speed (mech.)	$n_{max\ mech}$	RPM	10000	
Max. permissible speed (converter)	$n_{max\ Inv}$	RPM	10000	
Max. torque	M_{max}	Nm	6.5	
Max. current	I_{max}	A	8	
Physical constants				
Torque constant	k_T	Nm/A	0.86	
Voltage constant	k_E	V/1000 RPM	55	
Winding resistance at 20°C	R_{Str}	Ohm	4.5	
Cyclic inductance	L_D	mH	16.5	
Electrical time constant	T_{el}	ms	3.7	
Mechanical time constant	T_{mech}	ms	1.6	
Thermal time constant	T_{th}	min	30	
Shaft torsional stiffness	C_t	Nm/rad	5500	
Weight with brake	m_{MotBr}	kg	4.0	
Weight without brake	m_{Mot}	kg	3.7	
Recommended motor module 6SL312_-TE13-0AA_				
Rated current converter	$I_N\ Inv$	A	3	
Max. current converter	$I_{max\ Inv}$	A	6	
Max. torque at $I_{max\ Inv}$	$M_{max\ Inv}$	Nm	4.9	

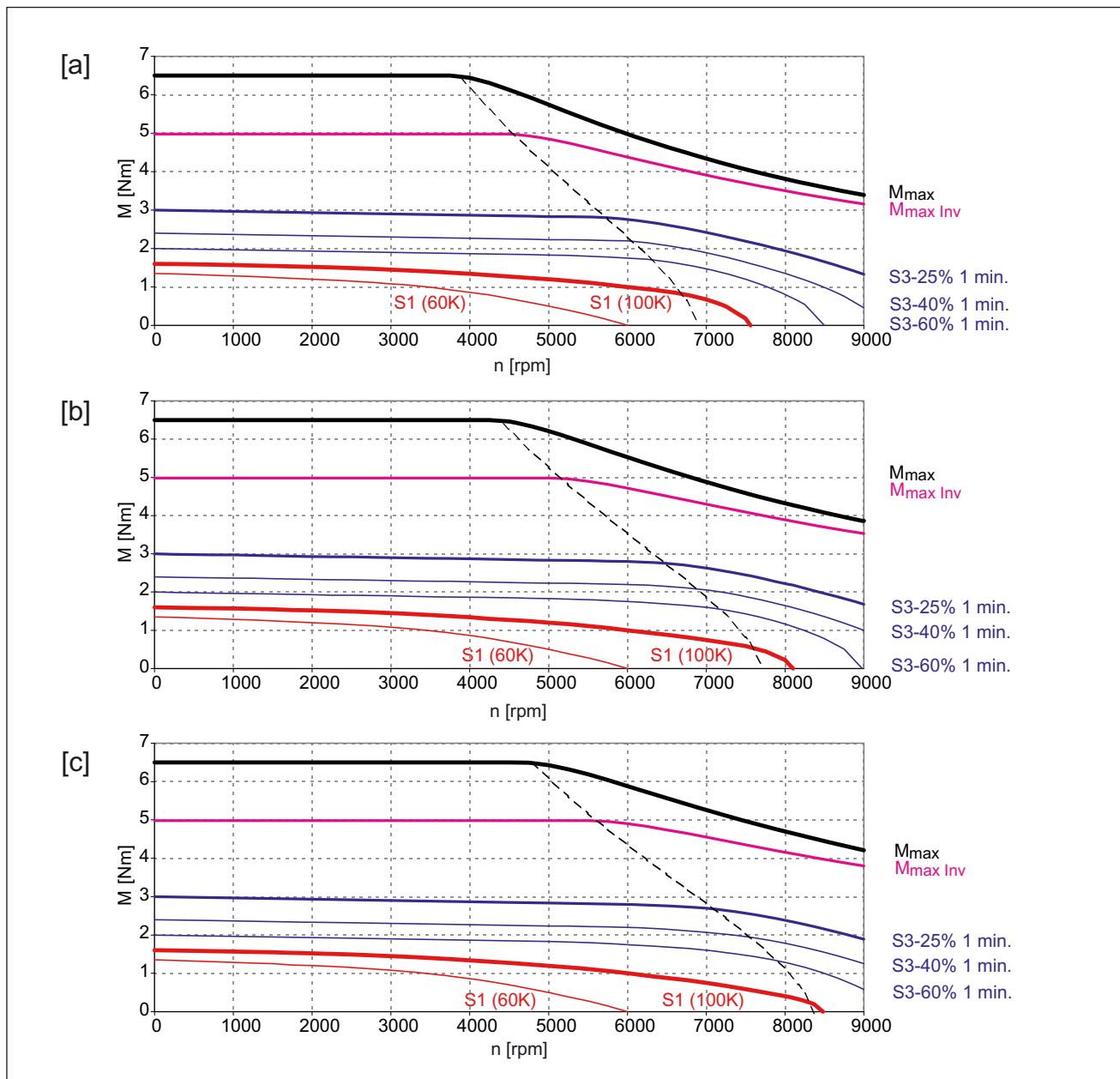

Figure 7-5 1FK7034-5AK71

- [a] SINAMICS SLM 400 V
- [b] SINAMICS ALM 400 V
- [c] SINAMICS SLM 480 V

Table 7-6 1FK7040 CT

Technical data	Code	Unit	-5AK71	
Configuration data				
Rated speed	n_N	RPM	6000	
No. of poles	2p		8	
Rated torque (100 K)	M_N (100 K)	Nm	1.1	
Rated current (100 K)	I_N	A	1.7	
Static torque (60 K)	M_0 (60 K)	Nm	1.3	
Static torque (100 K)	M_0 (100 K)	Nm	1.6	
Stall current (60 K)	I_0 (60 K)	A	1.8	
Stall current (100 K)	I_0 (100 K)	A	2.3	
Moment of inertia (with brake)	J_{MotBr}	10^{-4} kgm ²	2.41	
Moment of inertia (without brake)	J_{Mot}	10^{-4} kgm ²	1.7	
Optimum operating point				
Optimum speed	n_{opt}	RPM	6000	
Optimum power	P_{opt}	kW	0.69	
Limiting data				
Max. permissible speed (mech.)	$n_{max\ mech}$	RPM	9000	
Max. permissible speed (converter)	$n_{max\ Inv}$	RPM	8000	
Max. torque	M_{max}	Nm	5.1	
Max. current	I_{max}	A	7.7	
Physical constants				
Torque constant	k_T	Nm/A	0.68	
Voltage constant	k_E	V/1000 RPM	43	
Winding resistance at 20°C	R_{Str}	Ohm	3.3	
Cyclic inductance	L_D	mH	17.0	
Electrical time constant	T_{el}	ms	5.15	
Mechanical time constant	T_{mech}	ms	3.62	
Thermal time constant	T_{th}	min	25	
Shaft torsional stiffness	C_t	Nm/rad	19000	
Weight with brake	m_{MotBr}	kg	4.0	
Weight without brake	m_{Mot}	kg	3.5	
Recommended motor module 6SL312_-TE13-0AA_				
Rated current converter	$I_N\ Inv$	A	3	
Max. current converter	$I_{max\ Inv}$	A	6	
Max. torque at $I_{max\ Inv}$	$M_{max\ Inv}$	Nm	4.1	

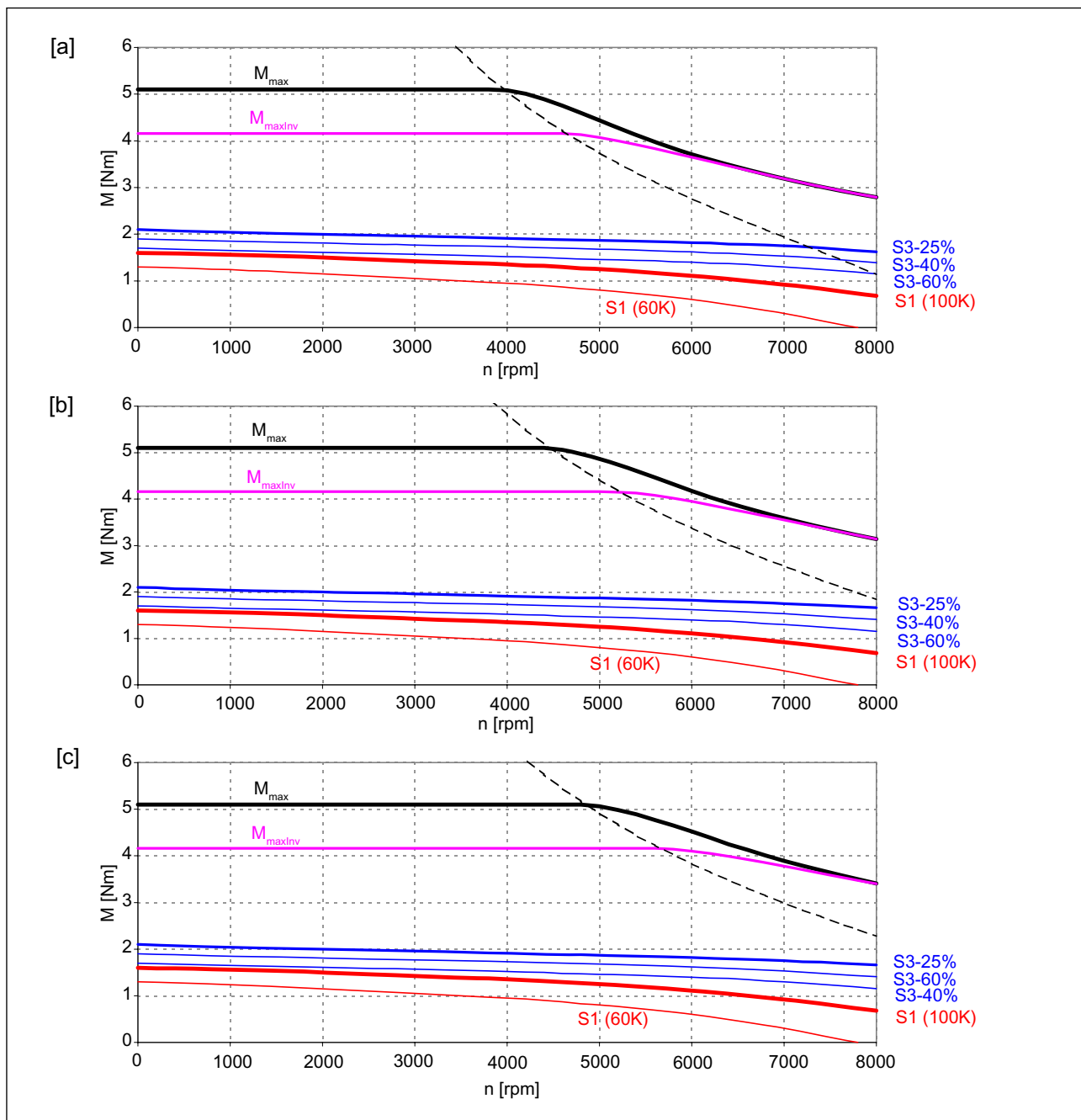

Figure 7-6 1FK7040-5AK71

- [a] SINAMICS SLM 400 V
- [b] SINAMICS ALM 400 V
- [c] SINAMICS SLM 480 V

Technical data and characteristics

7.2 1FK7 motors on SINAMICS S120 with 3 AC 400/480 V power supply

Table 7-7 1FK7042 CT

Technical data	Code	Unit	-5AF71	
Configuration data				
Rated speed	n_N	RPM	3000	
No. of poles	2p		8	
Rated torque (100 K)	M_N (100 K)	Nm	2.6	
Rated current (100 K)	I_N	A	1.95	
Static torque (60 K)	M_0 (60 K)	Nm	2.5	
Static torque (100 K)	M_0 (100 K)	Nm	3.0	
Stall current (60 K)	I_0 (60 K)	A	1.8	
Stall current (100 K)	I_0 (100 K)	A	2.2	
Moment of inertia (with brake)	J_{MotBr}	10^{-4} kgm ²	3.73	
Moment of inertia (without brake)	J_{Mot}	10^{-4} kgm ²	3.0	
Optimum operating point				
Optimum speed	n_{opt}	RPM	3000	
Optimum power	P_{opt}	kW	0.82	
Limiting data				
Max. permissible speed (mech.)	$n_{max\ mech}$	RPM	9000	
Max. permissible speed (converter)	$n_{max\ Inv}$	RPM	6500	
Max. torque	M_{max}	Nm	10.5	
Max. current	I_{max}	A	7.35	
Physical constants				
Torque constant	k_T	Nm/A	1.4	
Voltage constant	k_E	V/1000 RPM	89	
Winding resistance at 20°C	R_{Str}	Ohm	5.15	
Cyclic inductance	L_D	mH	29	
Electrical time constant	T_{el}	ms	5.6	
Mechanical time constant	T_{mech}	ms	2.37	
Thermal time constant	T_{th}	min	30	
Shaft torsional stiffness	C_t	Nm/rad	16000	
Weight with brake	m_{MotBr}	kg	5.4	
Weight without brake	m_{Mot}	kg	4.9	
Recommended motor module 6SL312_-TE13-0AA_				
Rated current converter	$I_N\ Inv$	A	3	
Max. current converter	$I_{max\ Inv}$	A	6	
Max. torque at $I_{max\ Inv}$	$M_{max\ Inv}$	Nm	8.4	

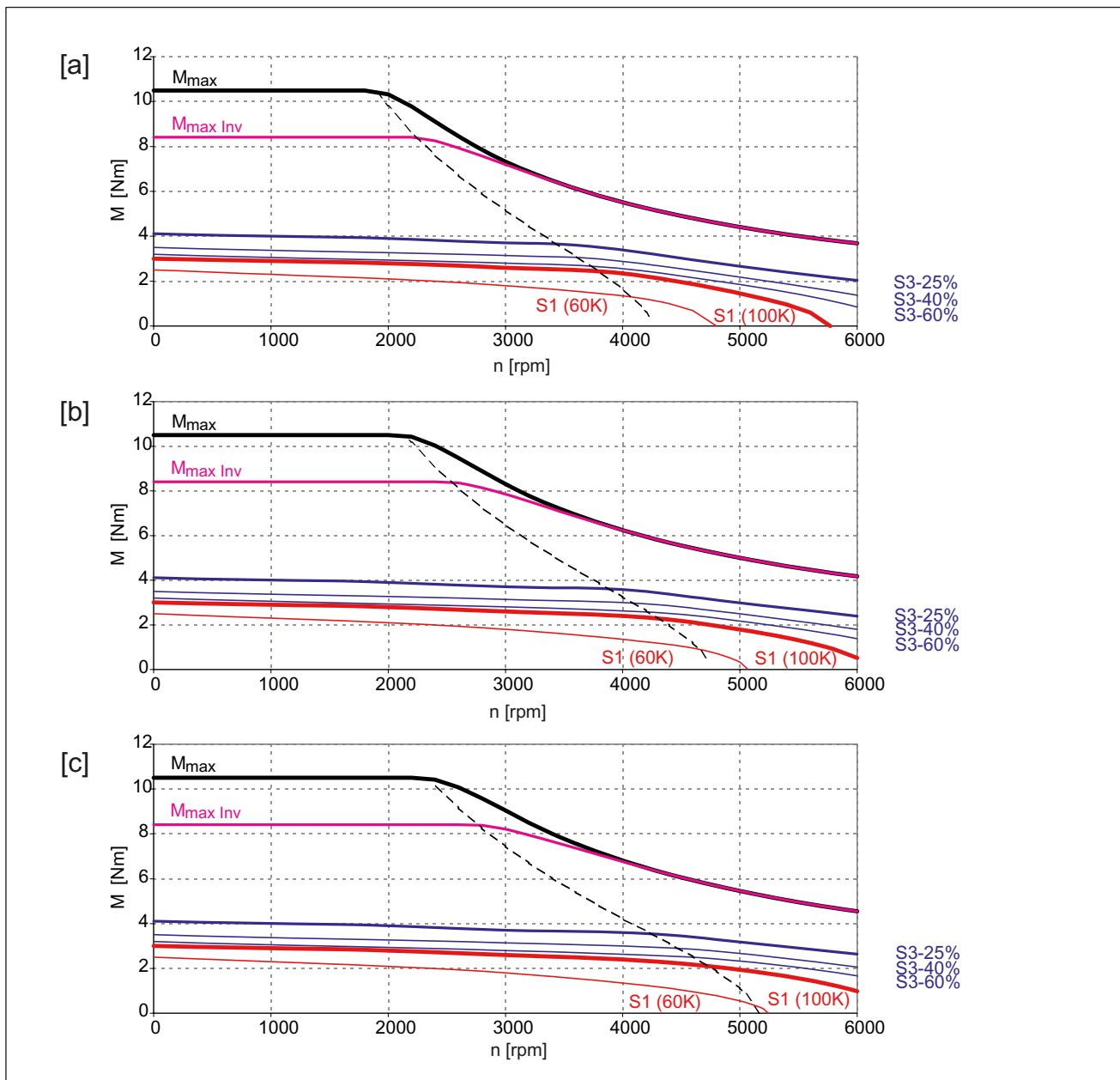

Figure 7-7 1FK7042-5AF71

- [a] SINAMICS SLM 400 V
- [b] SINAMICS ALM 400 V
- [c] SINAMICS SLM 480 V

Table 7-8 1FK7042 CT

Technical data	Code	Unit	-5AK71	
Configuration data				
Rated speed	n_N	RPM	6000	
No. of poles	2p		8	
Rated torque (100 K)	M_N (100 K)	Nm	1.5	
Rated current (100 K)	I_N	A	2.45	
Static torque (60 K)	M_0 (60 K)	Nm	2.5	
Static torque (100 K)	M_0 (100 K)	Nm	3.0	
Stall current (60 K)	I_0 (60 K)	A	3.6	
Stall current (100 K)	I_0 (100 K)	A	4.4	
Moment of inertia (with brake)	J_{MotBr}	10^{-4} kgm ²	3.73	
Moment of inertia (without brake)	J_{Mot}	10^{-4} kgm ²	3.0	
Optimum operating point				
Optimum speed	n_{opt}	RPM	5000	
Optimum power	P_{opt}	kW	1.02	
Limiting data				
Max. permissible speed (mech.)	$n_{max\ mech}$	RPM	9000	
Max. permissible speed (converter)	$n_{max\ Inv}$	RPM	8000	
Max. torque	M_{max}	Nm	10.5	
Max. current	I_{max}	A	15.3	
Physical constants				
Torque constant	k_T	Nm/A	0.69	
Voltage constant	k_E	V/1000 RPM	44	
Winding resistance at 20°C	R_{Str}	Ohm	1.2	
Cyclic inductance	L_D	mH	6.7	
Electrical time constant	T_{el}	ms	5.6	
Mechanical time constant	T_{mech}	ms	2.27	
Thermal time constant	T_{th}	min	30	
Shaft torsional stiffness	C_t	Nm/rad	16000	
Weight with brake	m_{MotBr}	kg	5.4	
Weight without brake	m_{Mot}	kg	4.9	
Recommended motor module 6SL312_-TE15-0AA_				
Rated current converter	$I_N\ Inv$	A	5	
Max. current converter	$I_{max\ Inv}$	A	10	
Max. torque at $I_{max\ Inv}$	$M_{max\ Inv}$	Nm	6.8	

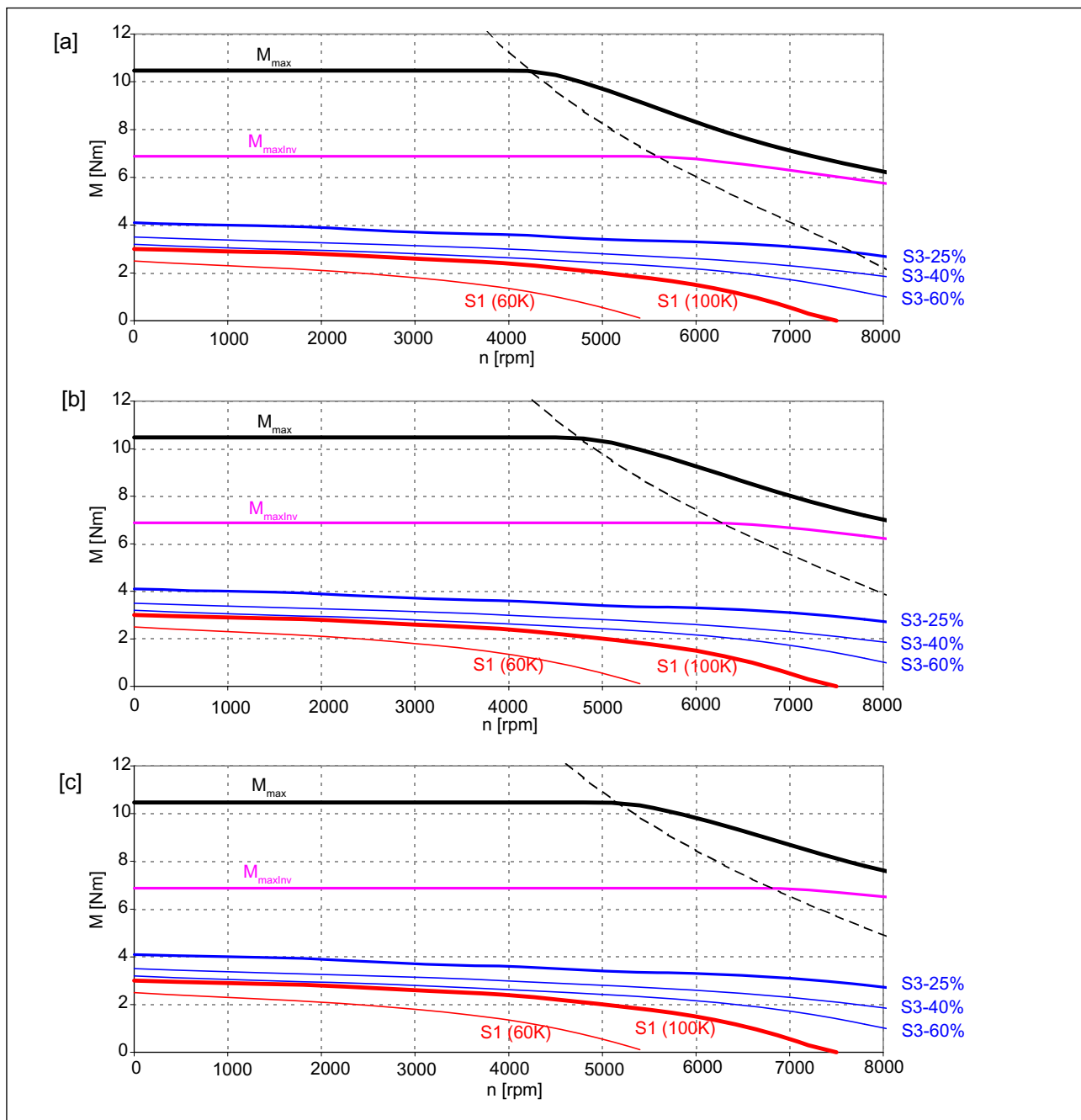

Figure 7-8 1FK7042-5AK71

- [a] SINAMICS SLM 400 V
- [b] SINAMICS ALM 400 V
- [c] SINAMICS SLM 480 V

Technical data and characteristics

7.2 1FK7 motors on SINAMICS S120 with 3 AC 400/480 V power supply

Table 7-9 1FK7060 CT

Technical data	Code	Unit	-5AF71	
Configuration data				
Rated speed	n_N	RPM	3000	
No. of poles	2p		8	
Rated torque (100 K)	M_N (100 K)	Nm	4.7	
Rated current (100 K)	I_N	A	3.7	
Static torque (60 K)	M_0 (60 K)	Nm	5	
Static torque (100 K)	M_0 (100 K)	Nm	6	
Stall current (60 K)	I_0 (60 K)	A	3.7	
Stall current (100 K)	I_0 (100 K)	A	4.5	
Moment of inertia (with brake)	J_{MotBr}	10^{-4} kgm ²	10.2	
Moment of inertia (without brake)	J_{Mot}	10^{-4} kgm ²	7.95	
Optimum operating point				
Optimum speed	n_{opt}	RPM	3000	
Optimum power	P_{opt}	kW	1.48	
Limiting data				
Max. permissible speed (mech.)	$n_{max\ mech}$	RPM	7200	
Max. permissible speed (converter)	$n_{max\ Inv}$	RPM	6800	
Max. torque	M_{max}	Nm	18	
Max. current	I_{max}	A	15	
Physical constants				
Torque constant	k_T	Nm/A	1.33	
Voltage constant	k_E	V/1000 RPM	84.5	
Winding resistance at 20°C	R_{Str}	Ohm	1.44	
Cyclic inductance	L_D	mH	14.7	
Electrical time constant	T_{el}	ms	10.2	
Mechanical time constant	T_{mech}	ms	1.94	
Thermal time constant	T_{th}	min	30	
Shaft torsional stiffness	C_t	Nm/rad	42000	
Weight with brake	m_{MotBr}	kg	8	
Weight without brake	m_{Mot}	kg	7	
Recommended motor module 6SL312_-TE15-0AA_				
Rated current converter	$I_N\ Inv$	A	5	
Max. current converter	$I_{max\ Inv}$	A	10	
Max. torque at $I_{max\ Inv}$	$M_{max\ Inv}$	Nm	13.2	

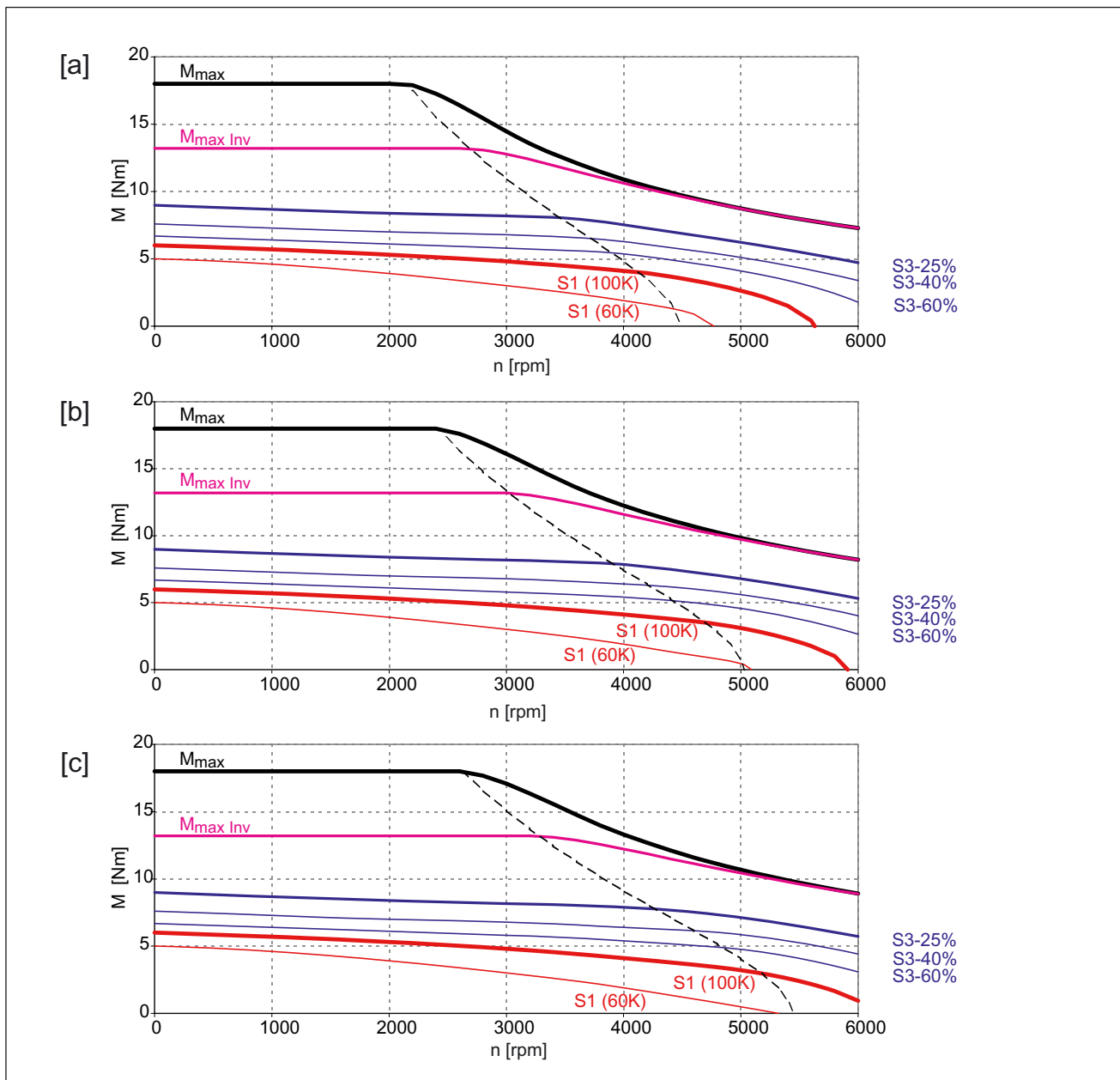

Figure 7-9 1FK7060-5AF71

- [a] SINAMICS SLM 400 V
- [b] SINAMICS ALM 400 V
- [c] SINAMICS SLM 480 V

Table 7-10 1FK7060 CT

Technical data	Code	Unit	-5AH71	
Configuration data				
Rated speed	n_N	RPM	4500	
No. of poles	2p		8	
Rated torque (100 K)	M_N (100 K)	Nm	3.7	
Rated current (100 K)	I_N	A	4.1	
Static torque (60 K)	M_0 (60 K)	Nm	5	
Static torque (100 K)	M_0 (100 K)	Nm	6	
Stall current (60 K)	I_0 (60 K)	A	5.1	
Stall current (100 K)	I_0 (100 K)	A	6.2	
Moment of inertia (with brake)	J_{MotBr}	10^{-4} kgm ²	10.2	
Moment of inertia (without brake)	J_{Mot}	10^{-4} kgm ²	7.95	
Optimum operating point				
Optimum speed	n_{opt}	RPM	4500	
Optimum power	P_{opt}	kW	1.74	
Limiting data				
Max. permissible speed (mech.)	$n_{max\ mech}$	RPM	7200	
Max. permissible speed (converter)	$n_{max\ Inv}$	RPM	7200	
Max. torque	M_{max}	Nm	18	
Max. current	I_{max}	A	19.5	
Physical constants				
Torque constant	k_T	Nm/A	0.95	
Voltage constant	k_E	V/1000 RPM	60.5	
Winding resistance at 20°C	R_{Str}	Ohm	0.73	
Cyclic inductance	L_D	mH	7.0	
Electrical time constant	T_{el}	ms	9.6	
Mechanical time constant	T_{mech}	ms	1.93	
Thermal time constant	T_{th}	min	30	
Shaft torsional stiffness	C_t	Nm/rad	42000	
Weight with brake	m_{MotBr}	kg	8	
Weight without brake	m_{Mot}	kg	7	
Recommended motor module 6SL312_-TE21-0AA_				
Rated current converter	$I_N\ Inv$	A	9	
Max. current converter	$I_{max\ Inv}$	A	18	
Max. torque at $I_{max\ Inv}$	$M_{max\ Inv}$	Nm	16.8	

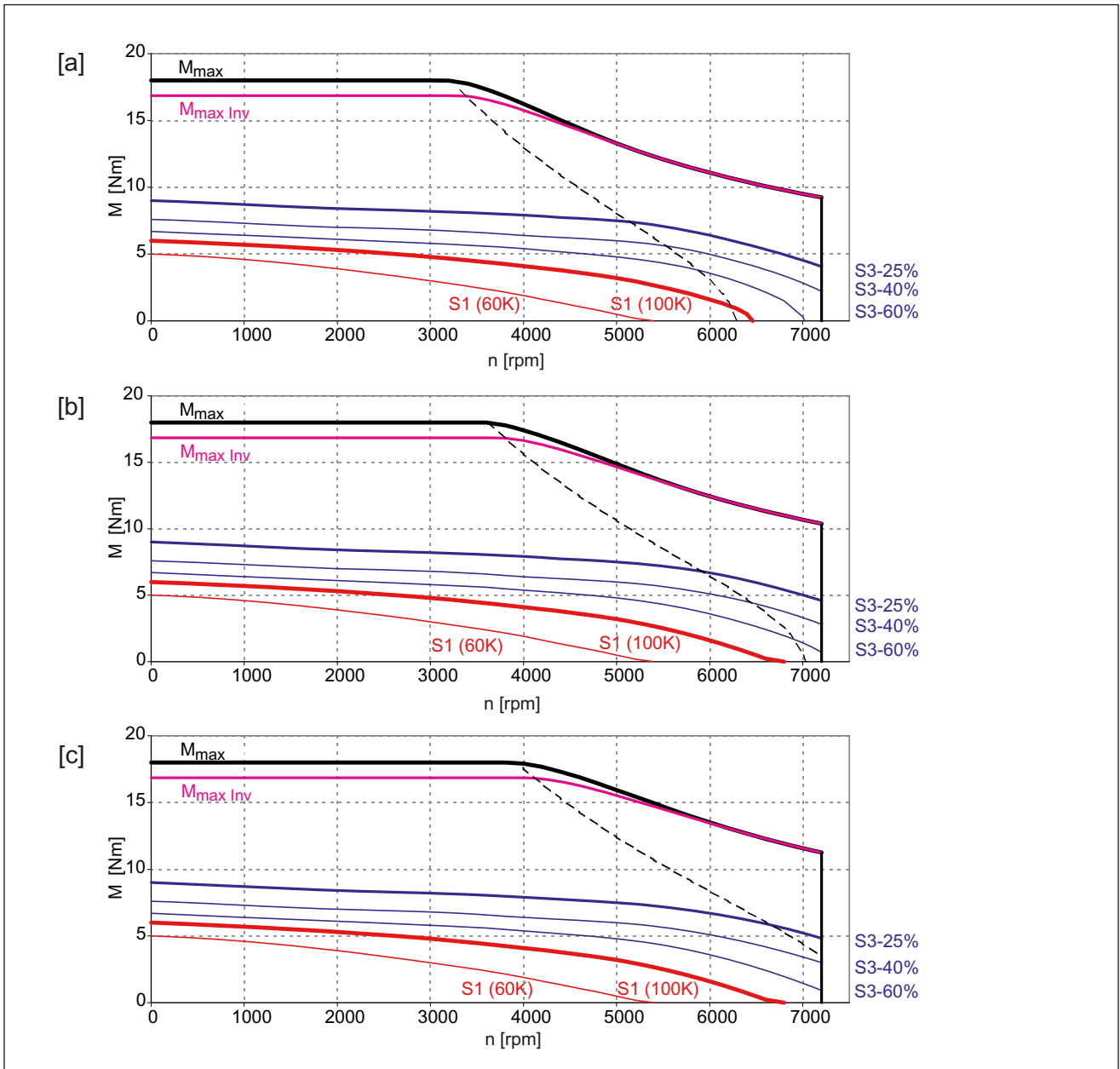

Figure 7-10 1FK7060-5AH71

- [a] SINAMICS SLM 400 V
- [b] SINAMICS ALM 400 V
- [c] SINAMICS SLM 480 V

Table 7-11 1FK7063 CT

Technical data	Code	Unit	-5AF71	
Configuration data				
Rated speed	n_N	RPM	3000	
No. of poles	2p		8	
Rated torque (100 K)	M_N (100 K)	Nm	7.3	
Rated current (100 K)	I_N	A	5.6	
Static torque (60 K)	M_0 (60 K)	Nm	9.1	
Static torque (100 K)	M_0 (100 K)	Nm	11	
Stall current (60 K)	I_0 (60 K)	A	6.6	
Stall current (100 K)	I_0 (100 K)	A	8.0	
Moment of inertia (with brake)	J_{MotBr}	10^{-4} kgm ²	17.3	
Moment of inertia (without brake)	J_{Mot}	10^{-4} kgm ²	15.1	
Optimum operating point				
Optimum speed	n_{opt}	RPM	3000	
Optimum power	P_{opt}	kW	2.29	
Limiting data				
Max. permissible speed (mech.)	$n_{max\ mech}$	RPM	7200	
Max. permissible speed (converter)	$n_{max\ Inv}$	RPM	6600	
Max. torque	M_{max}	Nm	35	
Max. current	I_{max}	A	28	
Physical constants				
Torque constant	k_T	Nm/A	1.37	
Voltage constant	k_E	V/1000 RPM	87.5	
Winding resistance at 20°C	R_{Str}	Ohm	0.65	
Cyclic inductance	L_D	mH	7.7	
Electrical time constant	T_{el}	ms	11.8	
Mechanical time constant	T_{mech}	ms	1.56	
Thermal time constant	T_{th}	min	40	
Shaft torsional stiffness	C_t	Nm/rad	35000	
Weight with brake	m_{MotBr}	kg	12	
Weight without brake	m_{Mot}	kg	11.5	
Recommended motor module 6SL312_-TE21-0AA_				
Rated current converter	$I_N\ Inv$	A	9	
Max. current converter	$I_{max\ Inv}$	A	18	
Max. torque at $I_{max\ Inv}$	$M_{max\ Inv}$	Nm	24.5	

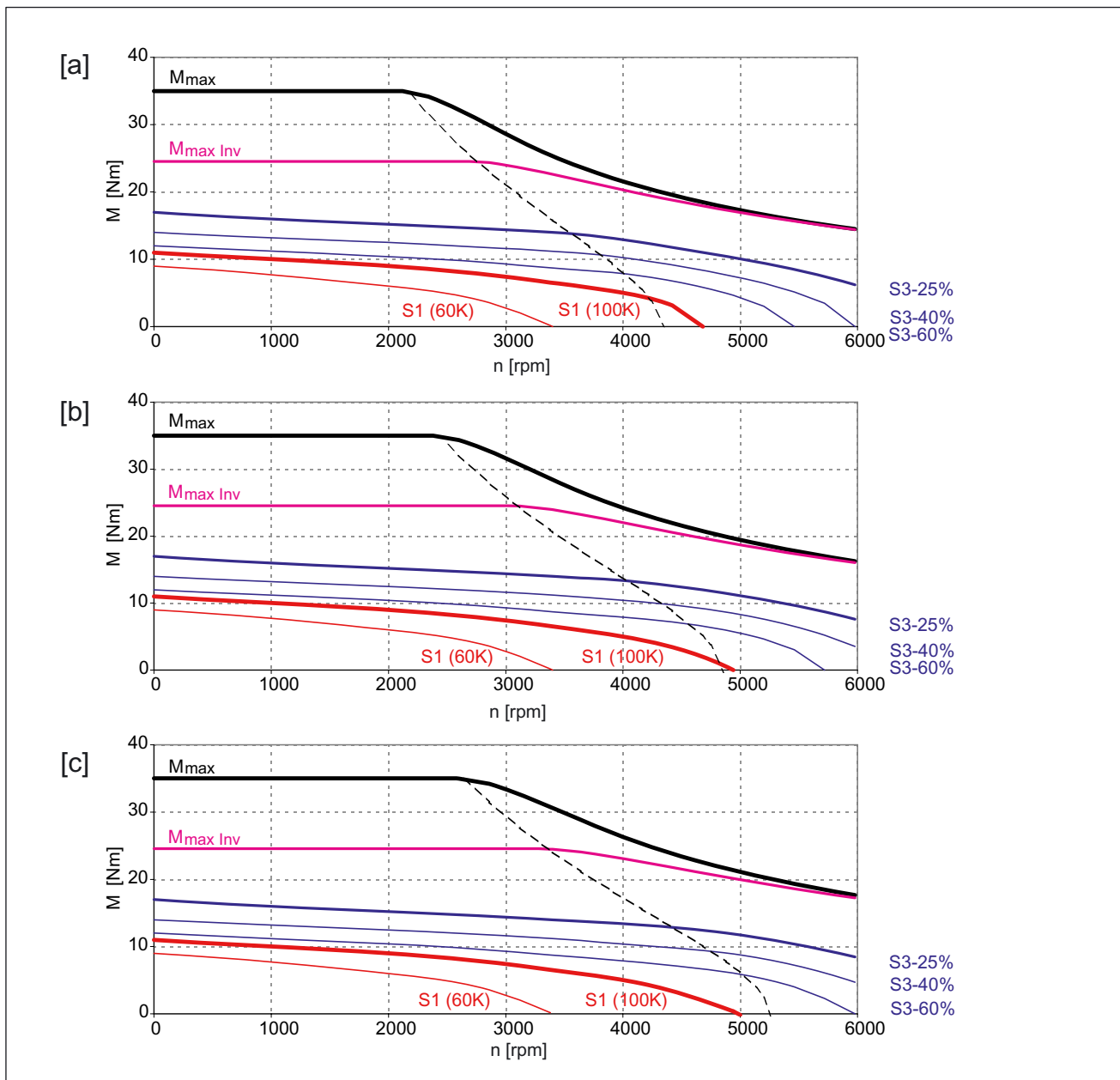

Figure 7-11 1FK7063-5AF71

- [a] SINAMICS SLM 400 V
- [b] SINAMICS ALM 400 V
- [c] SINAMICS SLM 480 V

Table 7-12 1FK7063 CT

Technical data	Code	Unit	-5AH71	
Configuration data				
Rated speed	n_N	RPM	4500	
No. of poles	2p		8	
Rated torque (100 K)	M_N (100 K)	Nm	3	
Rated current (100 K)	I_N	A	3.8	
Static torque (60 K)	M_0 (60 K)	Nm	9.1	
Static torque (100 K)	M_0 (100 K)	Nm	11	
Stall current (60 K)	I_0 (60 K)	A	9.9	
Stall current (100 K)	I_0 (100 K)	A	12.0	
Moment of inertia (with brake)	J_{MotBr}	10^{-4} kgm ²	17.3	
Moment of inertia (without brake)	J_{Mot}	10^{-4} kgm ²	15.1	
Optimum operating point				
Optimum speed	n_{opt}	RPM	3300	
Optimum power	P_{opt}	kW	2.32	
Limiting data				
Max. permissible speed (mech.)	$n_{max\ mech}$	RPM	7200	
Max. permissible speed (converter)	$n_{max\ Inv}$	RPM	7200	
Max. torque	M_{max}	Nm	35	
Max. current	I_{max}	A	42	
Physical constants				
Torque constant	k_T	Nm/A	0.91	
Voltage constant	k_E	V/1000 RPM	58	
Winding resistance at 20°C	R_{Str}	Ohm	0.29	
Cyclic inductance	L_D	mH	3.2	
Electrical time constant	T_{el}	ms	11	
Mechanical time constant	T_{mech}	ms	1.58	
Thermal time constant	T_{th}	min	40	
Shaft torsional stiffness	C_t	Nm/rad	35000	
Weight with brake	m_{MotBr}	kg	12	
Weight without brake	m_{Mot}	kg	11.5	
Recommended motor module 6SL312_-TE21-8AA_				
Rated current converter	$I_N\ Inv$	A	18	
Max. current converter	$I_{max\ Inv}$	A	36	
Max. torque at $I_{max\ Inv}$	$M_{max\ Inv}$	Nm	31.2	

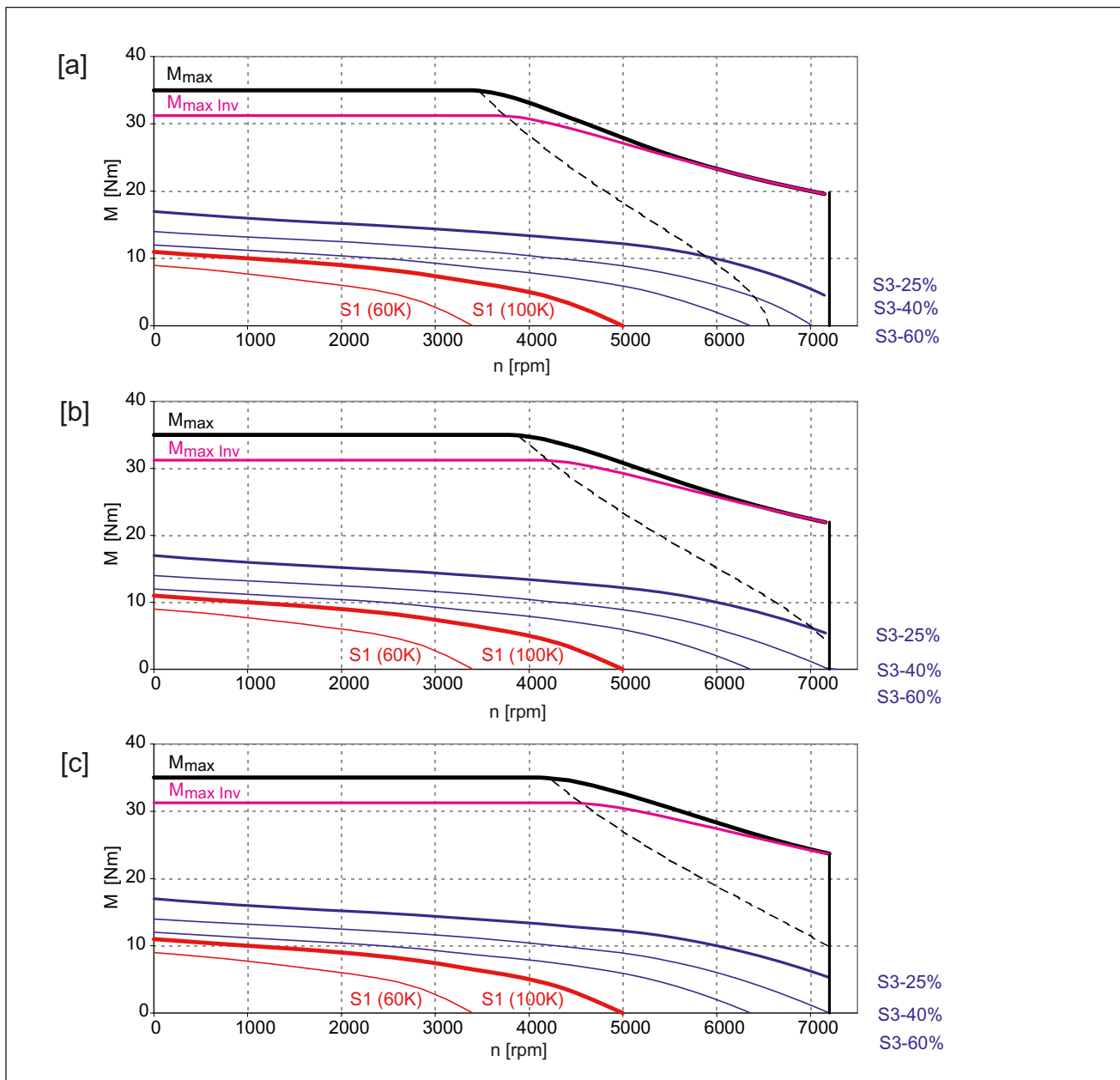

Figure 7-12 1FK7063-5AH71

- [a] SINAMICS SLM 400 V
- [b] SINAMICS ALM 400 V
- [c] SINAMICS SLM 480 V

Table 7-13 1FK7080 CT

Technical data	Code	Units	-5AF71	
Engineering data				
Rated speed	n_N	RPM	3000	
No. of poles	2p		8	
Rated torque (100 K)	M_N (100 K)	Nm	6.8	
Rated current (100 K)	I_N	A	4.4	
Static torque (60 K)	M_0 (60 K)	Nm	6.6	
Static torque (100 K)	M_0 (100 K)	Nm	8.0	
Stall current (60 K)	I_0 (60 K)	A	4.0	
Stall current (100 K)	I_0 (100 K)	A	4.8	
Moment of inertia (with brake)	J_{MotBr}	10^{-4} kgm ²	18.1	
Moment of inertia (without brake)	J_{Mot}	10^{-4} kgm ²	15.0	
Optimum operating point				
Optimum speed	n_{opt}	RPM	3000	
Optimum power	P_{opt}	kW	2.14	
Limiting data				
Max. permissible speed (mech.)	$n_{max\ mech}$	RPM	6000	
Max. permissible speed (converter)	$n_{max\ Inv}$	RPM	5600	
Max. torque	M_{max}	Nm	25	
Max. current	I_{max}	A	18	
Physical constants				
Torque constant	k_T	Nm/A	1.61	
Voltage constant	k_E	V/1000 RPM	102.5	
Winding resistance at 20°C	R_{Str}	Ohm	1.04	
Cyclic inductance	L_D	mH	14.0	
Electrical time constant	T_{el}	ms	13.5	
Mechanical time constant	T_{mech}	ms	1.78	
Thermal time constant	T_{th}	min	40	
Shaft torsional stiffness	C_t	Nm/rad	126000	
Weight with brake	m_{MotBr}	kg	12.5	
Weight without brake	m_{Mot}	kg	10	
Recommended motor module 6SL312_-TE15-0AA_				
Rated current converter	$I_N\ Inv$	A	5	
Max. current converter	$I_{max\ Inv}$	A	10	
Max. torque at $I_{max\ Inv}$	$M_{max\ Inv}$	Nm	16.6	

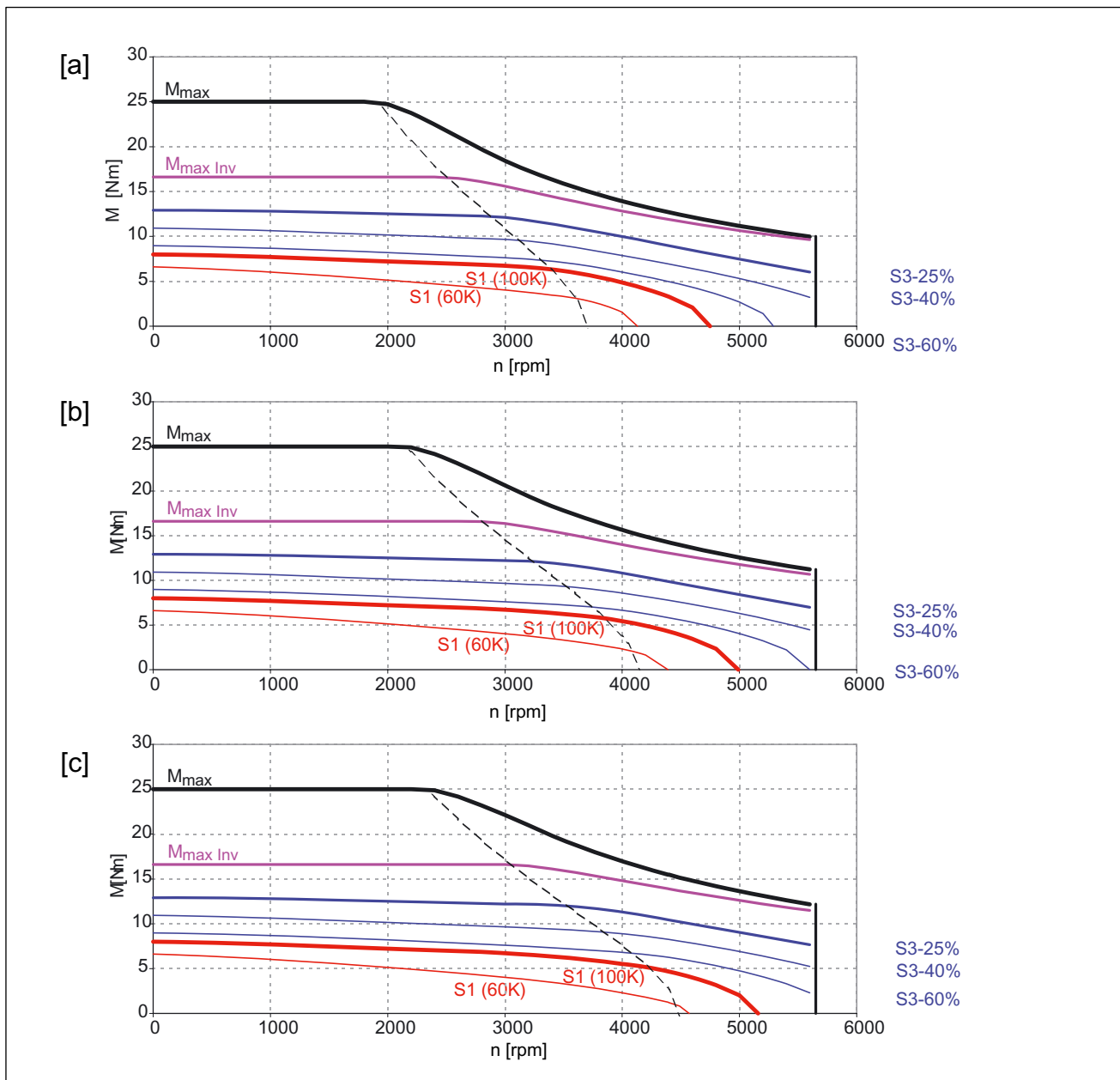

Figure 7-13 1FK7080-5AF71

- [a] SINAMICS SLM 400 V
- [b] SINAMICS ALM 400 V
- [c] SINAMICS SLM 480 V

Technical data and characteristics

7.2 1FK7 motors on SINAMICS S120 with 3 AC 400/480 V power supply

Table 7-14 1FK7080 CT

Technical data	Code	Unit	-5AH71	
Engineering data				
Rated speed	n_N	RPM	4500	
No. of poles	2p		8	
Rated torque (100 K)	M_N (100 K)	Nm	4.5	
Rated current (100 K)	I_N	A	4.7	
Static torque (60 K)	M_0 (60 K)	Nm	6.6	
Static torque (100 K)	M_0 (100 K)	Nm	8.0	
Stall current (60 K)	I_0 (60 K)	A	6.1	
Stall current (100 K)	I_0 (100 K)	A	7.4	
Moment of inertia (with brake)	J_{MotBr}	10^{-4} kgm ²	18.1	
Moment of inertia (without brake)	J_{Mot}	10^{-4} kgm ²	15.0	
Optimum operating point				
Optimum speed	n_{opt}	RPM	4000	
Optimum power	P_{opt}	kW	2.39	
Limiting data				
Max. permissible speed (mech.)	$n_{max\ mech}$	RPM	6000	
Max. permissible speed (converter)	$n_{max\ Inv}$	RPM	6000	
Max. torque	M_{max}	Nm	25	
Max. current	I_{max}	A	25	
Physical constants				
Torque constant	k_T	Nm/A	1.06	
Voltage constant	k_E	V/1000 RPM	68	
Winding resistance at 20°C	R_{Str}	Ohm	0.44	
Cyclic inductance	L_D	mH	6.3	
Electrical time constant	T_{el}	ms	14.3	
Mechanical time constant	T_{mech}	ms	1.76	
Thermal time constant	T_{th}	min	40	
Shaft torsional stiffness	C_t	Nm/rad	126000	
Weight with brake	m_{MotBr}	kg	12.5	
Weight without brake	m_{Mot}	kg	10	
Recommended motor module 6SL312_-TE15-0AA_				
Rated current converter	$I_N\ Inv$	A	9	
Max. current converter	$I_{max\ Inv}$	A	18	
Max. torque at $I_{max\ Inv}$	$M_{max\ Inv}$	Nm	19.1	

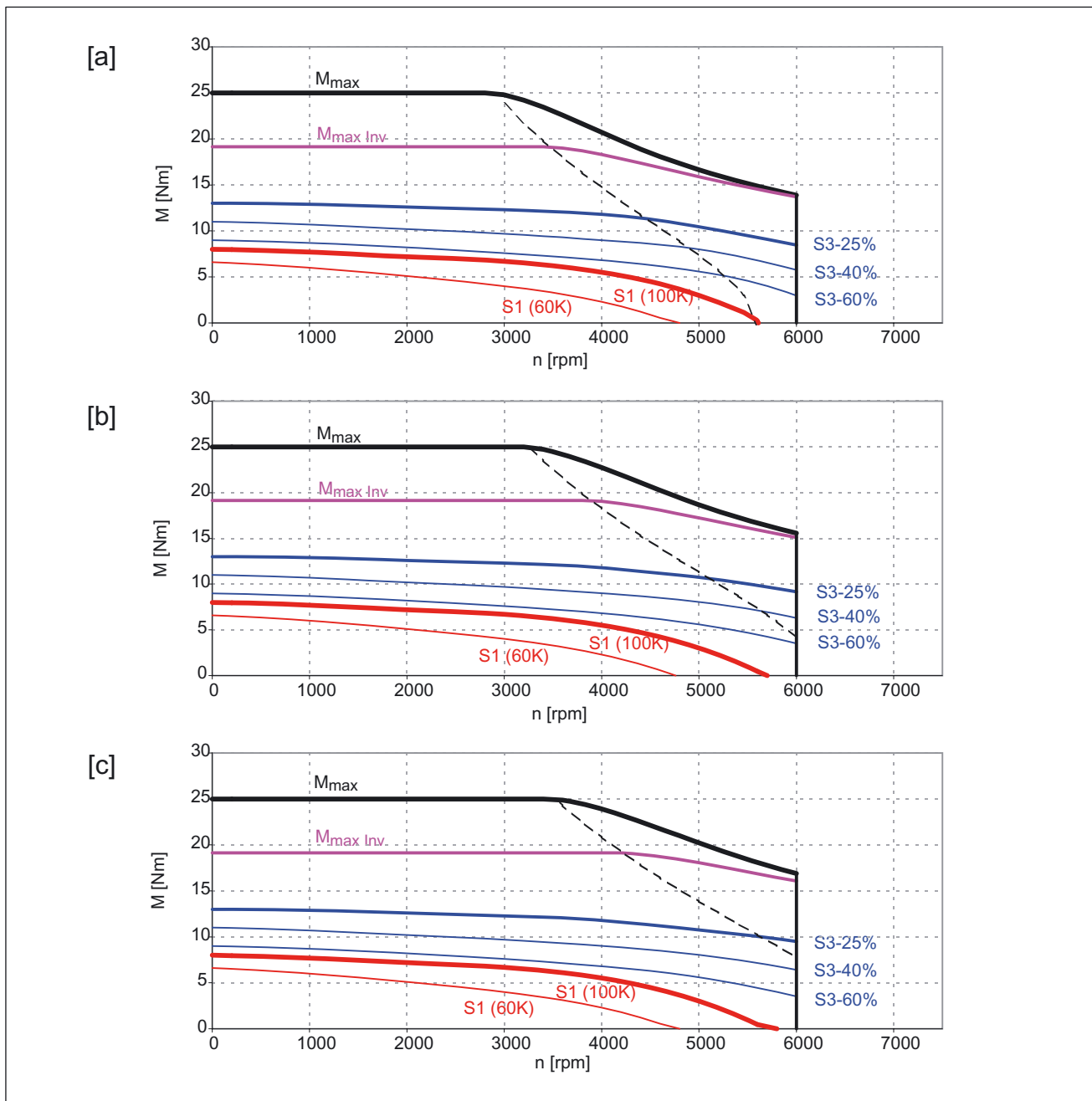

Figure 7-14 1FK7080-5AH71

- [a] SINAMICS SLM 400 V
- [b] SINAMICS ALM 400 V
- [c] SINAMICS SLM 480 V

Table 7-15 1FK7083 CT

Technical data	Code	Unit	-5AF71	
Engineering data				
Rated speed	n_N	RPM	3000	
No. of poles	2p		8	
Rated torque (100 K)	M_N (100 K)	Nm	10.5	
Rated current (100 K)	I_N	A	7.4	
Static torque (60 K)	M_0 (60 K)	Nm	13.3	
Static torque (100 K)	M_0 (100 K)	Nm	16	
Stall current (60 K)	I_0 (60 K)	A	8.6	
Stall current (100 K)	I_0 (100 K)	A	10.4	
Moment of inertia (with brake)	J_{MotBr}	10^{-4} kgm ²	35.9	
Moment of inertia (without brake)	J_{Mot}	10^{-4} kgm ²	27.3	
Optimum operating point				
Optimum speed	n_{opt}	RPM	3000	
Optimum power	P_{opt}	kW	3.3	
Limiting data				
Max. permissible speed (mech.)	$n_{max\ mech}$	RPM	6000	
Max. permissible speed (converter)	$n_{max\ Inv}$	RPM	5900	
Max. torque	M_{max}	Nm	50	
Max. current	I_{max}	A	37	
Physical constants				
Torque constant	k_T	Nm/A	1.52	
Voltage constant	k_E	V/1000 RPM	97	
Winding resistance at 20°C	R_{Str}	Ohm	0.4	
Cyclic inductance	L_D	mH	6.0	
Electrical time constant	T_{el}	ms	15	
Mechanical time constant	T_{mech}	ms	1.41	
Thermal time constant	T_{th}	min	50	
Shaft torsional stiffness	C_t	Nm/rad	105000	
Weight with brake	m_{MotBr}	kg	16.5	
Weight without brake	m_{Mot}	kg	14	
Recommended motor module 6SL312_-TE21-0AA_				
Rated current converter	$I_N\ Inv$	A	9	
Max. current converter	$I_{max\ Inv}$	A	18	
Max. torque at $I_{max\ Inv}$	$M_{max\ Inv}$	Nm	27.8	

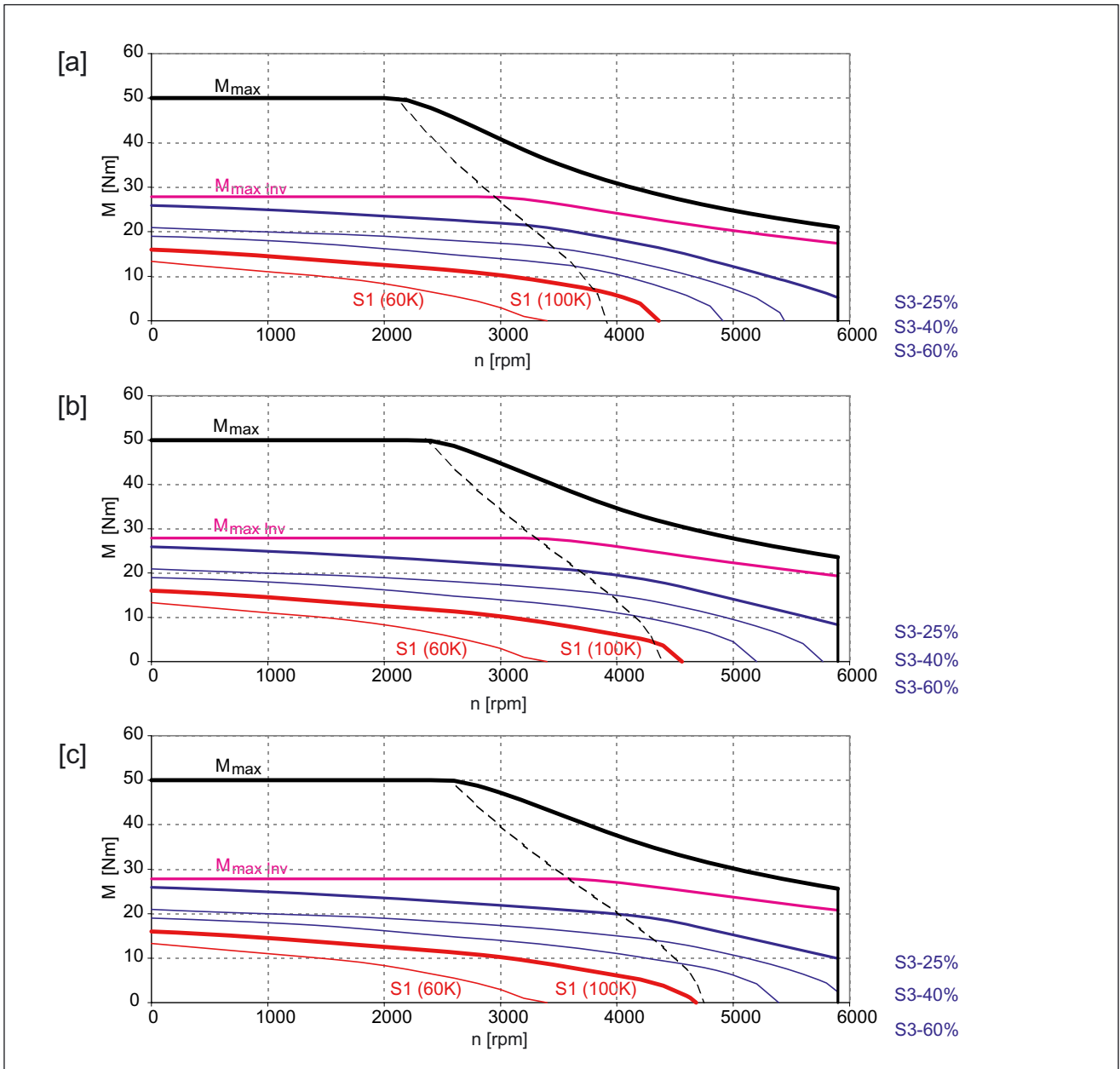

Figure 7-15 1FK7083-5AF71

- [a] SINAMICS SLM 400 V
- [b] SINAMICS ALM 400 V
- [c] SINAMICS SLM 480 V

Technical data and characteristics

7.2 1FK7 motors on SINAMICS S120 with 3 AC 400/480 V power supply

Table 7-16 1FK7083 CT

Technical data	Code	Unit	-5AH71	
Engineering data				
Rated speed	n_N	RPM	4500	
No. of poles	2p		8	
Rated torque (100 K)	M_N (100 K)	Nm	3	
Rated current (100 K)	I_N	A	3.6	
Static torque (60 K)	M_0 (60 K)	Nm	13.3	
Static torque (100 K)	M_0 (100 K)	Nm	16	
Stall current (60 K)	I_0 (60 K)	A	12.4	
Stall current (100 K)	I_0 (100 K)	A	15.0	
Moment of inertia (with brake)	J_{MotBr}	10^{-4} kgm ²	35.9	
Moment of inertia (without brake)	J_{Mot}	10^{-4} kgm ²	27.3	
Optimum operating point				
Optimum speed	n_{opt}	RPM	3000	
Optimum power	P_{opt}	kW	3.30	
Limiting data				
Max. permissible speed (mech.)	$n_{max\ mech}$	RPM	6000	
Max. permissible speed (converter)	$n_{max\ Inv}$	RPM	6000	
Max. torque	M_{max}	Nm	50	
Max. current	I_{max}	A	52	
Physical constants				
Torque constant	k_T	Nm/A	1.05	
Voltage constant	k_E	V/1000 RPM	67	
Winding resistance at 20°C	R_{Str}	Ohm	0.17	
Cyclic inductance	L_D	mH	2.9	
Electrical time constant	T_{el}	ms	17	
Mechanical time constant	T_{mech}	ms	1.26	
Thermal time constant	T_{th}	min	50	
Shaft torsional stiffness	C_t	Nm/rad	105000	
Weight with brake	m_{MotBr}	kg	16.5	
Weight without brake	m_{Mot}	kg	14	
Recommended motor module 6SL312_-TE21-8AA_				
Rated current converter	$I_N\ Inv$	A	18	
Max. current converter	$I_{max\ Inv}$	A	36	
Max. torque at $I_{max\ Inv}$	$M_{max\ Inv}$	Nm	37.7	

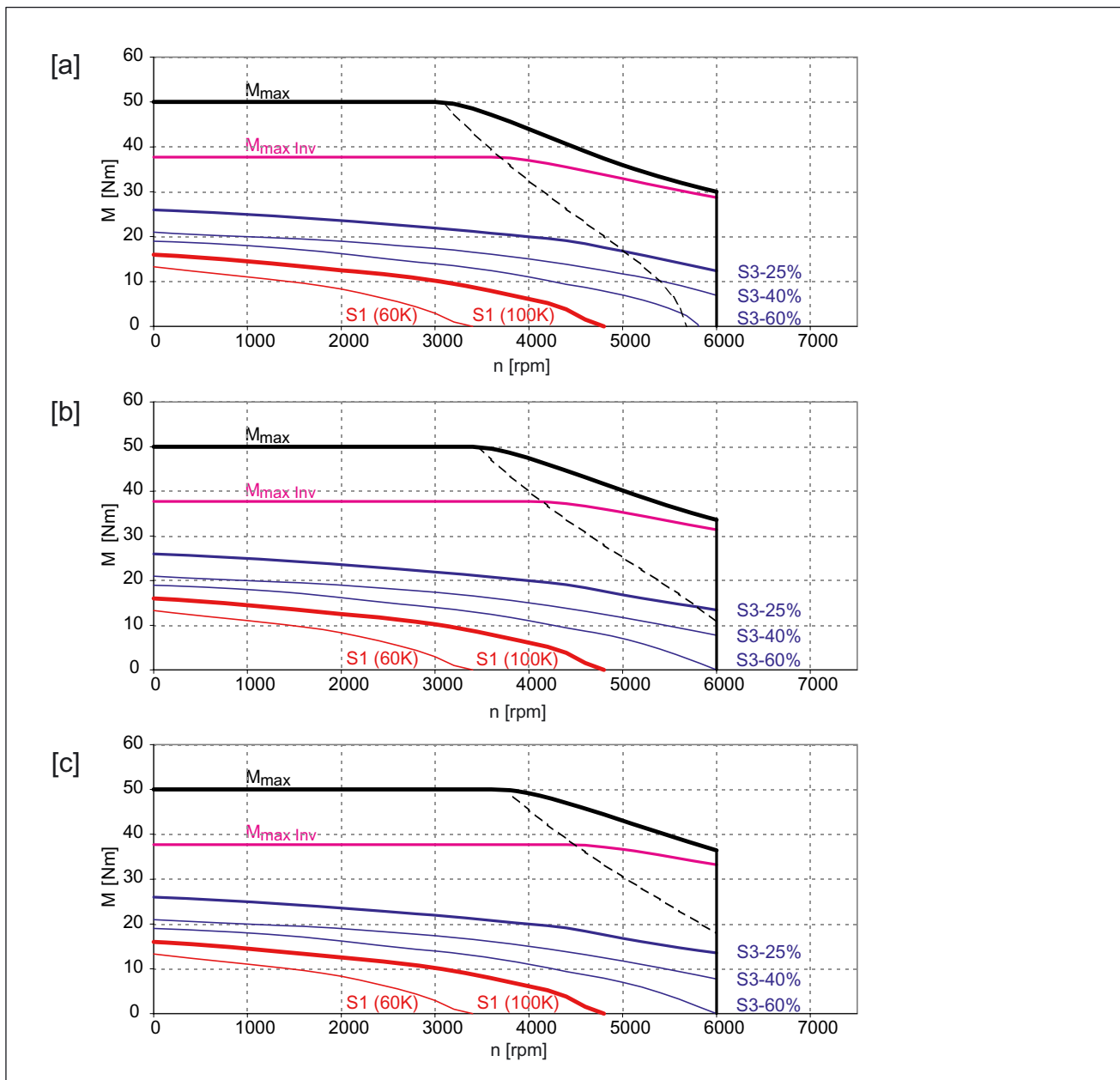

Figure 7-16 1FK7083-5AH71

- [a] SINAMICS SLM 400 V
- [b] SINAMICS ALM 400 V
- [c] SINAMICS SLM 480 V

Table 7-17 1FK7100 CT

Technical data	Code	Unit	-5AF71	
Configuration data				
Rated speed	n_N	RPM	3000	
No. of poles	2p		8	
Rated torque (100 K)	M_N (100 K)	Nm	12	
Rated current (100 K)	I_N	A	8	
Static torque (60 K)	M_0 (60 K)	Nm	15	
Static torque (100 K)	M_0 (100 K)	Nm	18	
Stall current (60 K)	I_0 (60 K)	A	9.2	
Stall current (100 K)	I_0 (100 K)	A	11.2	
Moment of inertia (with brake)	J_{MotBr}	10^{-4} kgm ²	63.9	
Moment of inertia (without brake)	J_{Mot}	10^{-4} kgm ²	55.3	
Optimum operating point				
Optimum speed	n_{opt}	RPM	3000	
Optimum power	P_{opt}	kW	3.77	
Limiting data				
Max. permissible speed (mech.)	$n_{max\ mech}$	RPM	5000	
Max. permissible speed (converter)	$n_{max\ Inv}$	RPM	5000	
Max. torque	M_{max}	Nm	55	
Max. current	I_{max}	A	37	
Physical constants				
Torque constant	k_T	Nm/A	1.59	
Voltage constant	k_E	V/1000 RPM	101	
Winding resistance at 20°C	R_{Str}	Ohm	0.34	
Cyclic inductance	L_D	mH	7.0	
Electrical time constant	T_{el}	ms	20.5	
Mechanical time constant	T_{mech}	ms	2.23	
Thermal time constant	T_{th}	min	55	
Shaft torsional stiffness	C_t	Nm/rad	184000	
Weight with brake	m_{MotBr}	kg	21.5	
Weight without brake	m_{Mot}	kg	19	
Recommended motor module 6SL312_-TE21-8AA_				
Rated current converter	$I_N\ Inv$	A	18	
Max. current converter	$I_{max\ Inv}$	A	36	
Max. torque at $I_{max\ Inv}$	$M_{max\ Inv}$	Nm	53.8	

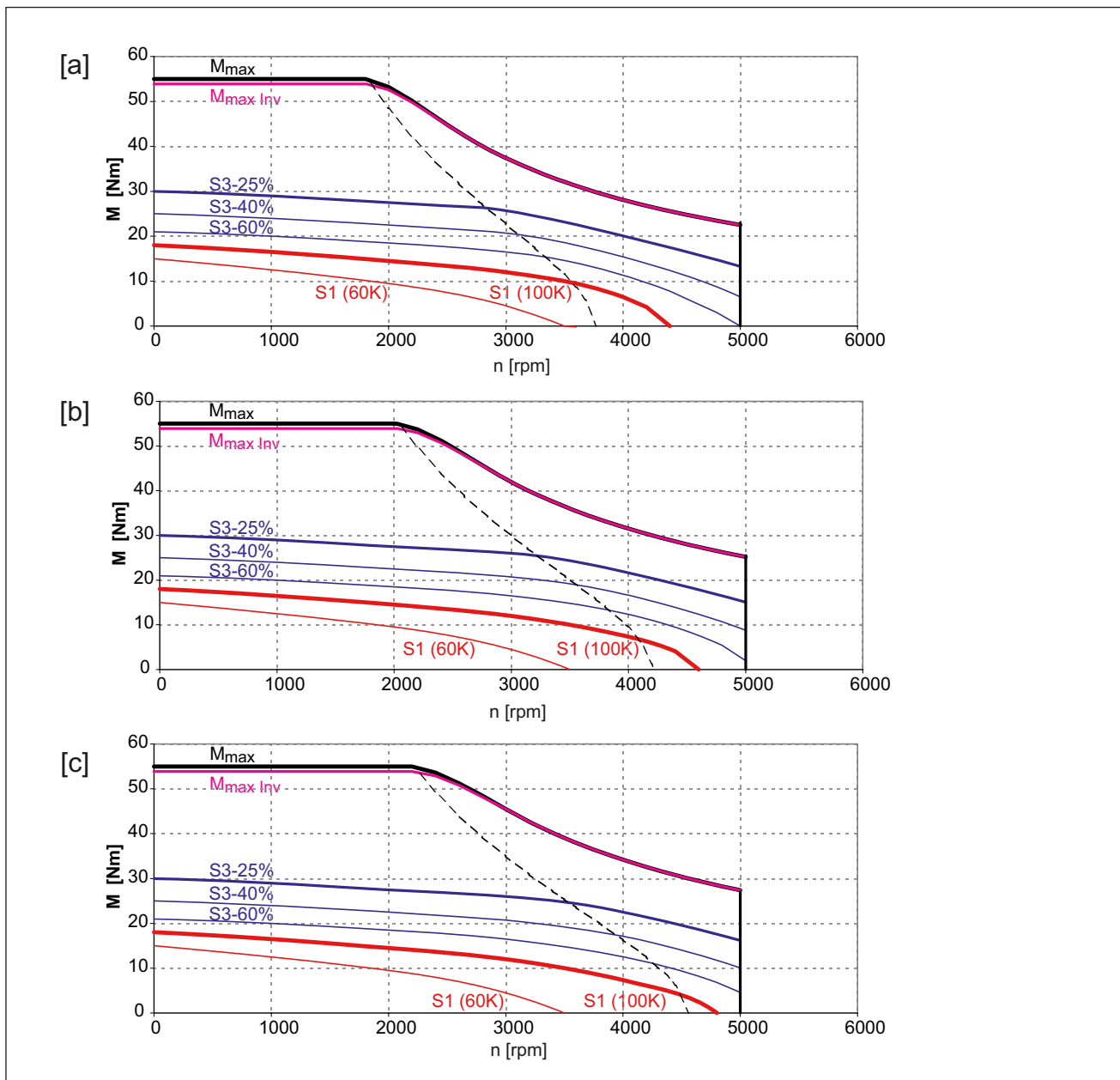

Figure 7-17 1FK7100-5AF71

- [a] SINAMICS SLM 400 V
- [b] SINAMICS ALM 400 V
- [c] SINAMICS SLM 480 V

Technical data and characteristics

7.2 1FK7 motors on SINAMICS S120 with 3 AC 400/480 V power supply

Table 7-18 1FK7101 CT

Technical data	Code	Unit	-5AF71	
Configuration data				
Rated speed	n_N	RPM	3000	
No. of poles	2p		8	
Rated torque (100 K)	M_N (100 K)	Nm	15.5	
Rated current (100 K)	I_N	A	11.8	
Static torque (60 K)	M_0 (60 K)	Nm	22.4	
Static torque (100 K)	M_0 (100 K)	Nm	27	
Stall current (60 K)	I_0 (60 K)	A	15.7	
Stall current (100 K)	I_0 (100 K)	A	19	
Moment of inertia (with brake)	J_{MotBr}	10^{-4} kgm ²	92.3	
Moment of inertia (without brake)	J_{Mot}	10^{-4} kgm ²	79.9	
Optimum operating point				
Optimum speed	n_{opt}	RPM	3000	
Optimum power	P_{opt}	kW	4.87	
Limiting data				
Max. permissible speed (mech.)	$n_{max\ mech}$	RPM	5000	
Max. permissible speed (converter)	$n_{max\ Inv}$	RPM	5000	
Max. torque	M_{max}	Nm	80	
Max. current	I_{max}	A	63	
Physical constants				
Torque constant	k_T	Nm/A	1.41	
Voltage constant	k_E	V/1000 RPM	90	
Winding resistance at 20°C	R_{Str}	Ohm	0.15	
Cyclic inductance	L_D	mH	3.0	
Electrical time constant	T_{el}	ms	20	
Mechanical time constant	T_{mech}	ms	1.80	
Thermal time constant	T_{th}	min	60	
Shaft torsional stiffness	C_t	Nm/rad	165000	
Weight with brake	m_{MotBr}	kg	24	
Weight without brake	m_{Mot}	kg	21	
Recommended motor module 6SL312_-TE21-8AA_				
Rated current converter	$I_N\ Inv$	A	18	
Max. current converter	$I_{max\ Inv}$	A	36	
Max. torque at $I_{max\ Inv}$	$M_{max\ Inv}$	Nm	51	

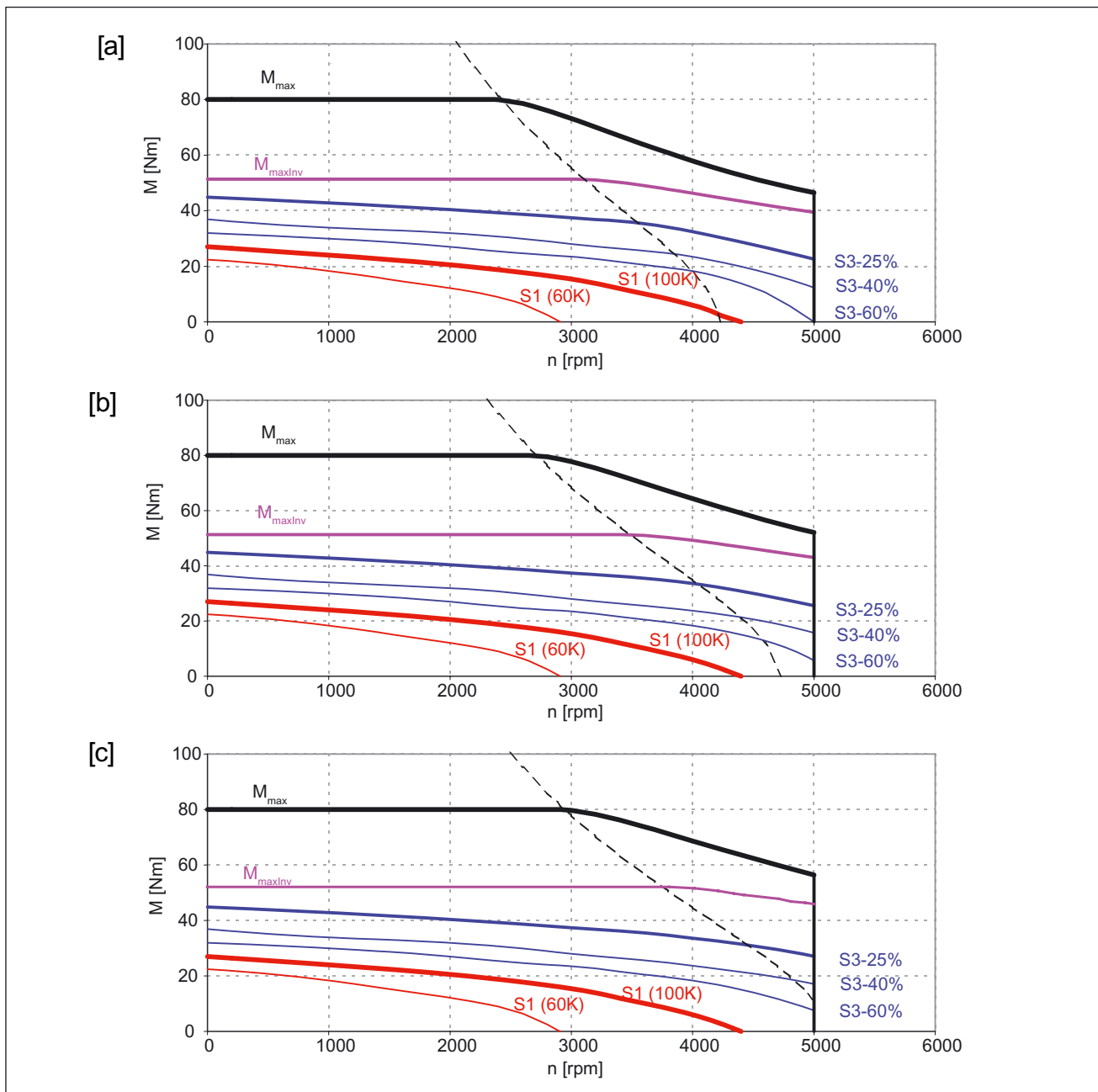

Figure 7-18 1FK7101-5AF71

- [a] SINAMICS SLM 400 V
- [b] SINAMICS ALM 400 V
- [c] SINAMICS SLM 480 V

Table 7-19 1FK7103 CT

Technical data	Code	Unit	-5AF71	
Configuration data				
Rated speed	n_N	RPM	3000	
No. of poles	2p		8	
Rated torque (100 K)	M_N (100 K)	Nm	14	
Rated current (100 K)	I_N	A	12	
Static torque (60 K)	M_0 (60 K)	Nm	30	
Static torque (100 K)	M_0 (100 K)	Nm	36	
Stall current (60 K)	I_0 (60 K)	A	22.8	
Stall current (100 K)	I_0 (100 K)	A	27.5	
Moment of inertia (with brake)	J_{MotBr}	10^{-4} kgm ²	118	
Moment of inertia (without brake)	J_{Mot}	10^{-4} kgm ²	105	
Optimum operating point				
Optimum speed	n_{opt}	RPM	2500	
Optimum power	P_{opt}	kW	5.37	
Limiting data				
Max. permissible speed (mech.)	$n_{max\ mech}$	RPM	5000	
Max. permissible speed (converter)	$n_{max\ Inv}$	RPM	5000	
Max. torque	M_{max}	Nm	108	
Max. current	I_{max}	A	84	
Physical constants				
Torque constant	k_T	Nm/A	1.35	
Voltage constant	k_E	V/1000 RPM	86	
Winding resistance at 20°C	R_{Str}	Ohm	0.09	
Cyclic inductance	L_D	mH	2.0	
Electrical time constant	T_{el}	ms	22.2	
Mechanical time constant	T_{mech}	ms	1.55	
Thermal time constant	T_{th}	min	65	
Shaft torsional stiffness	C_t	Nm/rad	149000	
Weight with brake	m_{MotBr}	kg	32	
Weight without brake	m_{Mot}	kg	29	
Recommended motor module 6SL312_-TE23-0AA_				
Rated current converter	$I_N\ Inv$	A	30	
Max. current converter	$I_{max\ Inv}$	A	56	
Max. torque at $I_{max\ Inv}$	$M_{max\ Inv}$	Nm	73	

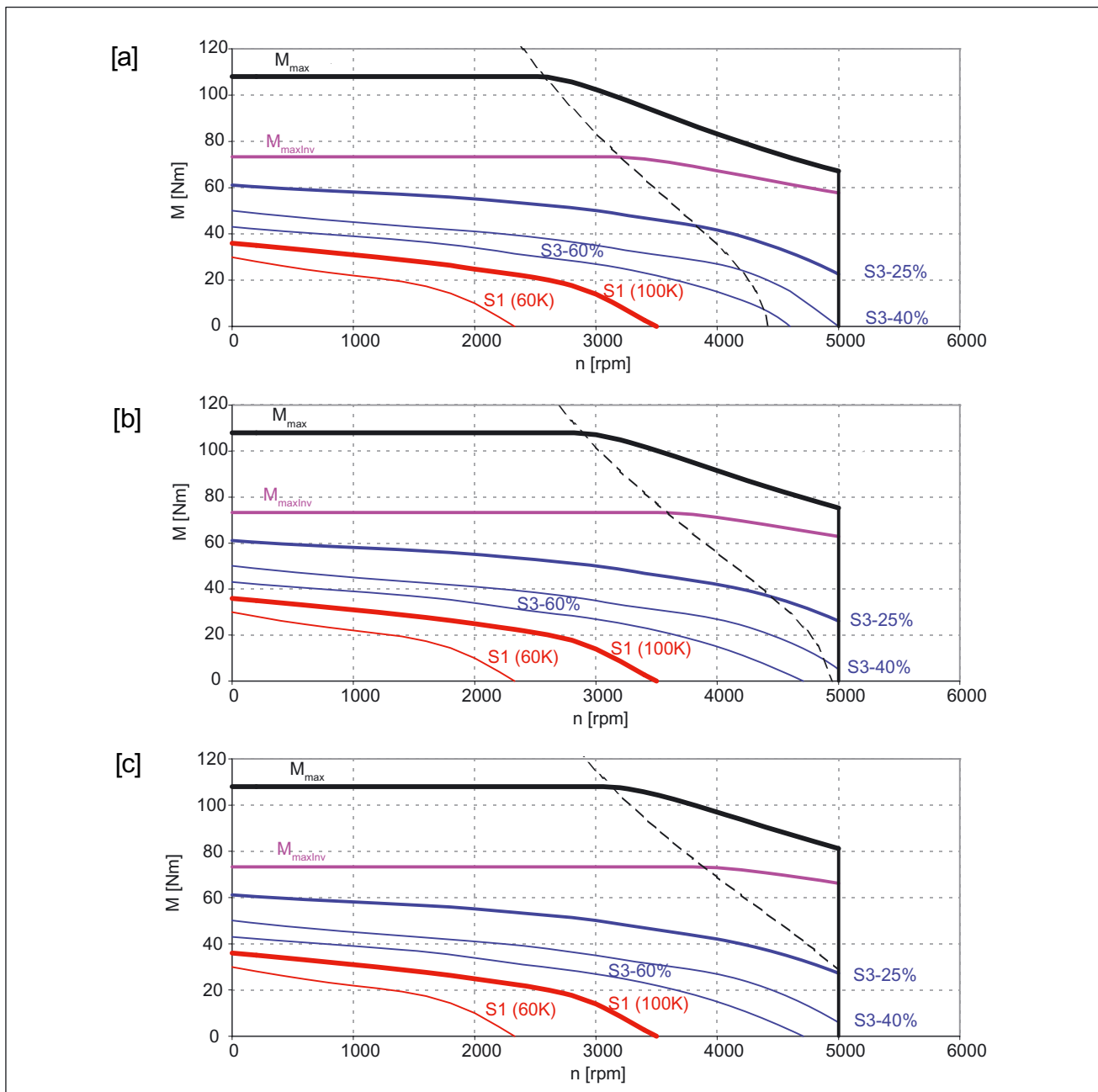

Figure 7-19 1FK7103-5AF71

- [a] SINAMICS SLM 400 V
- [b] SINAMICS ALM 400 V
- [c] SINAMICS SLM 480 V

Table 7-20 1FK7105 CT

Technical data	Code	Unit	-5AC71	
Configuration data				
Rated speed	n_N	RPM	2000	
No. of poles	2p		8	
Rated torque (100 K)	M_N (100 K)	Nm	37	
Rated current (100 K)	I_N	A	16	
Static torque (60 K)	M_0 (60 K)	Nm	40	
Static torque (100 K)	M_0 (100 K)	Nm	48	
Stall current (60 K)	I_0 (60 K)	A	17	
Stall current (100 K)	I_0 (100 K)	A	20	
Moment of inertia (with brake)	J_{MotBr}	10^{-4} kgm ²	169	
Moment of inertia (without brake)	J_{Mot}	10^{-4} kgm ²	156	
Optimum operating point				
Optimum speed	n_{opt}	RPM	2000	
Optimum power	P_{opt}	kW	7.75	
Limiting data				
Max. permissible speed (mech.)	$n_{max\ mech}$	RPM	5000	
Max. permissible speed (converter)	$n_{max\ Inv}$	RPM	3800	
Max. torque	M_{max}	Nm	150	
Max. current	I_{max}	A	72	
Physical constants				
Torque constant	k_T	Nm/A	2.37	
Voltage constant	k_E	V/1000 RPM	151	
Winding resistance at 20°C	R_{Str}	Ohm	0.17	
Cyclic inductance	L_D	mH	4.4	
Electrical time constant	T_{el}	ms	26	
Mechanical time constant	T_{mech}	ms	1.4	
Thermal time constant	T_{th}	min	70	
Shaft torsional stiffness	C_t	Nm/rad	125000	
Weight with brake	m_{MotBr}	kg	41.5	
Weight without brake	m_{Mot}	kg	39.1	
Recommended motor module 6SL312_-TE23-0AA_				
Rated current converter	$I_N\ Inv$	A	30	
Max. current converter	$I_{max\ Inv}$	A	56	
Max. torque at $I_{max\ Inv}$	$M_{max\ Inv}$	Nm	127	

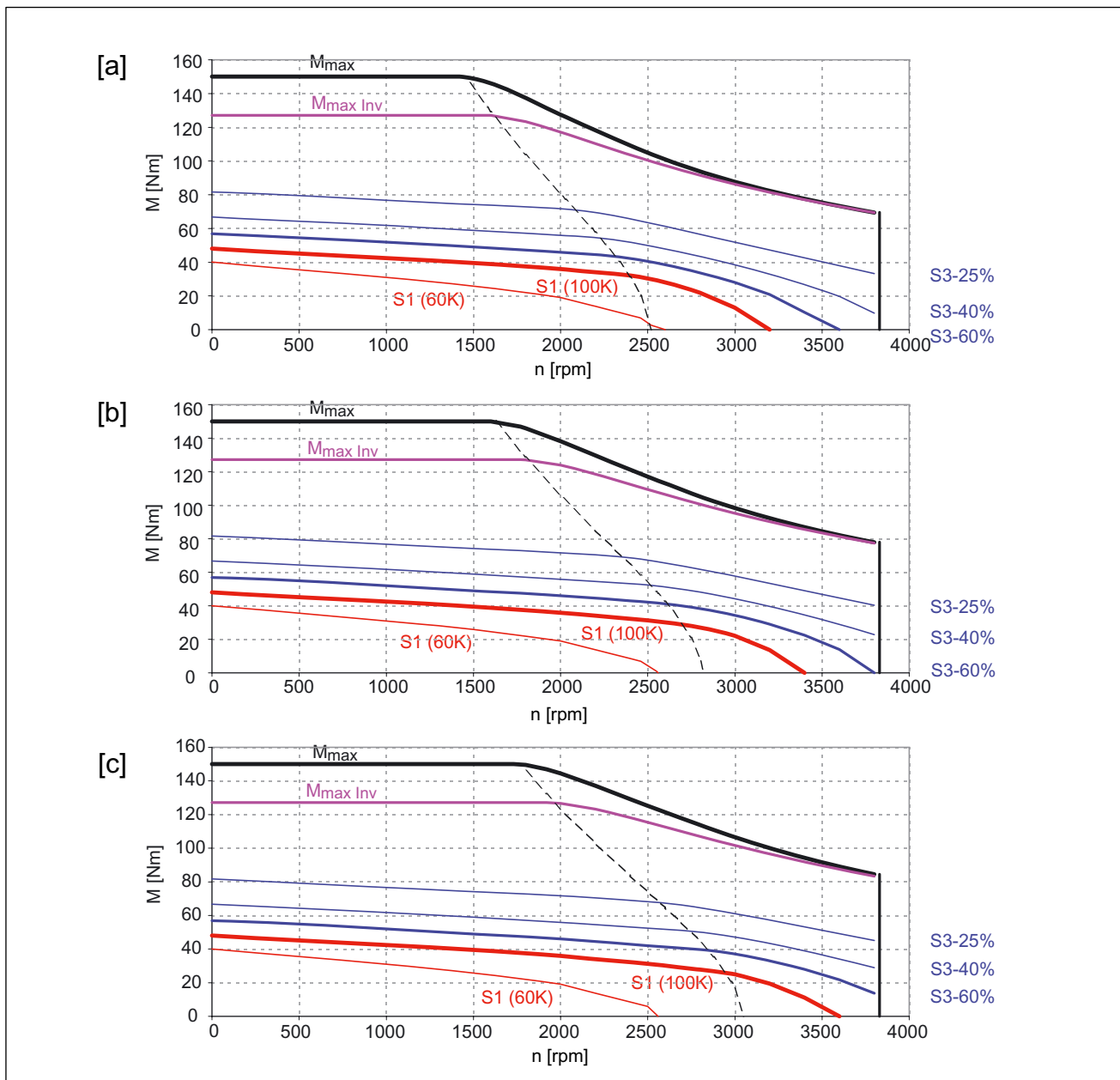

Figure 7-20 1FK7105-5AC71

- [a] SINAMICS SLM 400 V
- [b] SINAMICS ALM 400 V
- [c] SINAMICS SLM 480 V

Technical data and characteristics

7.2 1FK7 motors on SINAMICS S120 with 3 AC 400/480 V power supply

Table 7-21 1FK7105 CT

Technical data	Code	Unit	-5AF71	
Configuration data				
Rated speed	n_N	RPM	3000	
No. of poles	2p		8	
Rated torque (100 K)	M_N (100 K)	Nm	26	
Rated current (100 K)	I_N	A	18	
Static torque (60 K)	M_0 (60 K)	Nm	40	
Static torque (100 K)	M_0 (100 K)	Nm	48	
Stall current (60 K)	I_0 (60 K)	A	25	
Stall current (100 K)	I_0 (100 K)	A	31	
Moment of inertia (with brake)	J_{MotBr}	10^{-4} kgm ²	169	
Moment of inertia (without brake)	J_{Mot}	10^{-4} kgm ²	156	
Optimum operating point				
Optimum speed	n_{opt}	RPM	3000	
Optimum power	P_{opt}	kW	8.17	
Limiting data				
Max. permissible speed (mech.)	$n_{max\ mech}$	RPM	5000	
Max. permissible speed (converter)	$n_{max\ Inv}$	RPM	5000	
Max. torque	M_{max}	Nm	150	
Max. current	I_{max}	A	109	
Physical constants				
Torque constant	k_T	Nm/A	1.57	
Voltage constant	k_E	V/1000 RPM	100	
Winding resistance at 20°C	R_{Str}	Ohm	0.074	
Cyclic inductance	L_D	mH	1.9	
Electrical time constant	T_{el}	ms	26	
Mechanical time constant	T_{mech}	ms	1.4	
Thermal time constant	T_{th}	min	70	
Shaft torsional stiffness	C_t	Nm/rad	125000	
Weight with brake	m_{MotBr}	kg	41.5	
Weight without brake	m_{Mot}	kg	39.1	
Recommended motor module 6SL312_-TE23-0AA_				
Rated current converter	$I_N\ Inv$	A	30	
Max. current converter	$I_{max\ Inv}$	A	56	
Max. torque at $I_{max\ Inv}$	$M_{max\ Inv}$	Nm	87	

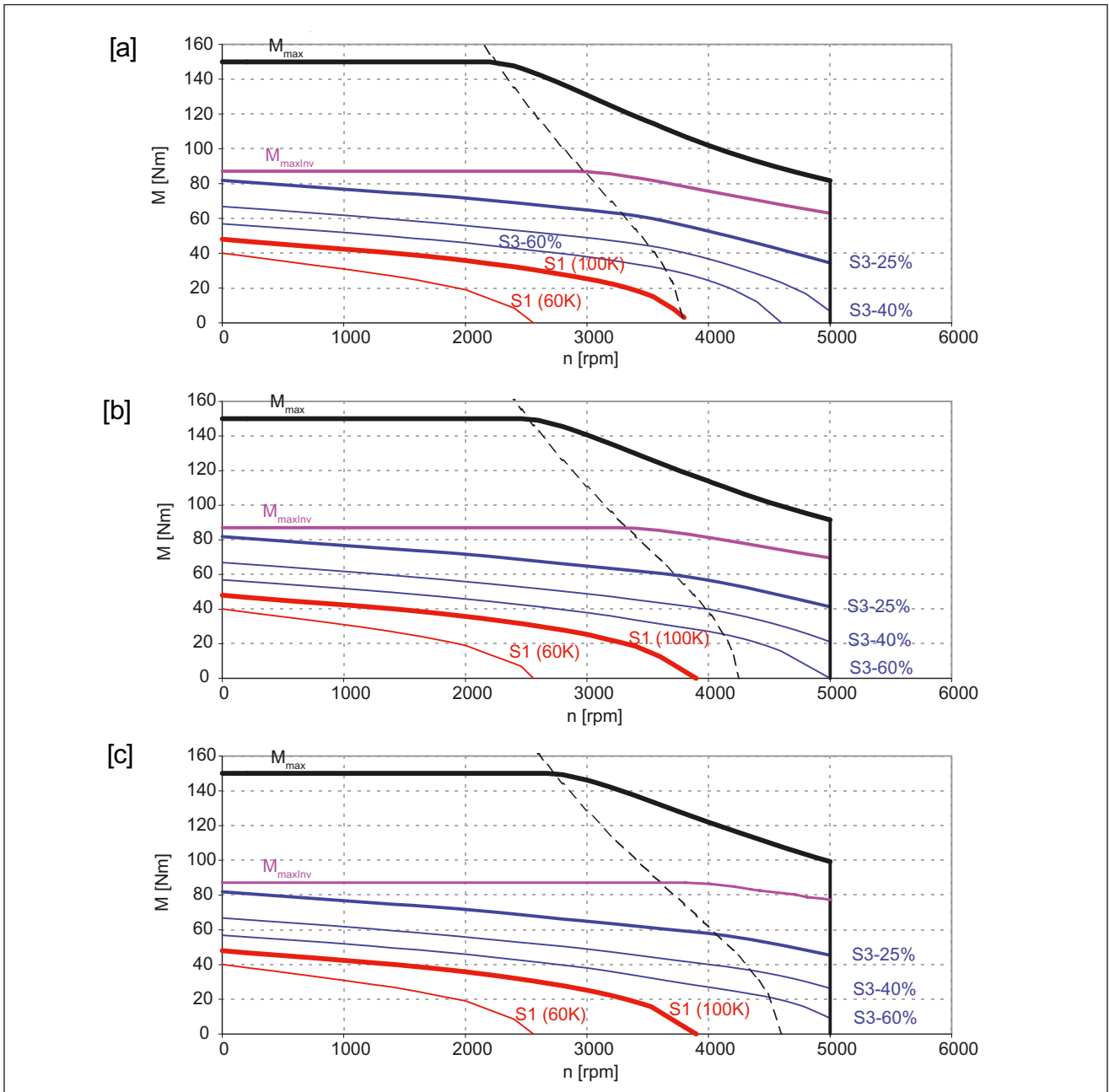

Figure 7-21 1FK7105-5AF71

- [a] SINAMICS SLM 400 V
- [b] SINAMICS ALM 400 V
- [c] SINAMICS SLM 480 V

7.2.2 1FK7 High Dynamic

Table 7-22 1FK7033 HD

Technical data	Code	Unit	-7AK71	
Configuration data				
Rated speed	n_N	RPM	6000	
No. of poles	2p		6	
Rated torque (100 K)	M_N (100 K)	Nm	0,9	
Rated current (100 K)	I_N	A	1,5	
Static torque (60 K)	M_0 (60 K)	Nm	1,0	
Static torque (100 K)	M_0 (100 K)	Nm	1,3	
Stall current (60 K)	I_0 (60 K)	A	1,7	
Stall current (100 K)	I_0 (100 K)	A	2,2	
Moment of inertia (with brake)	J_{MotBr}	10^{-4} kgm ²	0,3	
Moment of inertia (without brake)	J_{Mot}	10^{-4} kgm ²	0,27	
Optimum operating point				
Optimum speed	n_{opt}	RPM	6000	
Optimum power	P_{opt}	kW	0,56	
Limiting data				
Max. permissible speed (mech.)	$n_{max\ mech}$	RPM	10000	
Max. permissible speed (converter)	$n_{max\ Inv}$	RPM	10000	
Max. torque	M_{max}	Nm	4,3	
Max. current	I_{max}	A	7,2	
Physical constants				
Torque constant	k_T	Nm/A	0,6	
Voltage constant	k_E	V/1000 RPM	40	
Winding resistance at 20°C	R_{Str}	Ohm	3,7	
Cyclic inductance	L_D	mH	18	
Electrical time constant	T_{el}	ms	4,9	
Mechanical time constant	T_{mech}	ms	0,83	
Thermal time constant	T_{th}	min	25	
Shaft torsional stiffness	C_t	Nm/rad	8000	
Weight with brake	m_{MotBr}	kg	3,4	
Weight without brake	m_{Mot}	kg	3,1	
Recommended motor module 6SL312_- _TE13-0AA_				
Rated current converter	$I_N\ Inv$	A	3	
Max. current converter	$I_{max\ Inv}$	A	6	
Max. torque at $I_{max\ Inv}$	$M_{max\ Inv}$	Nm	3,5	

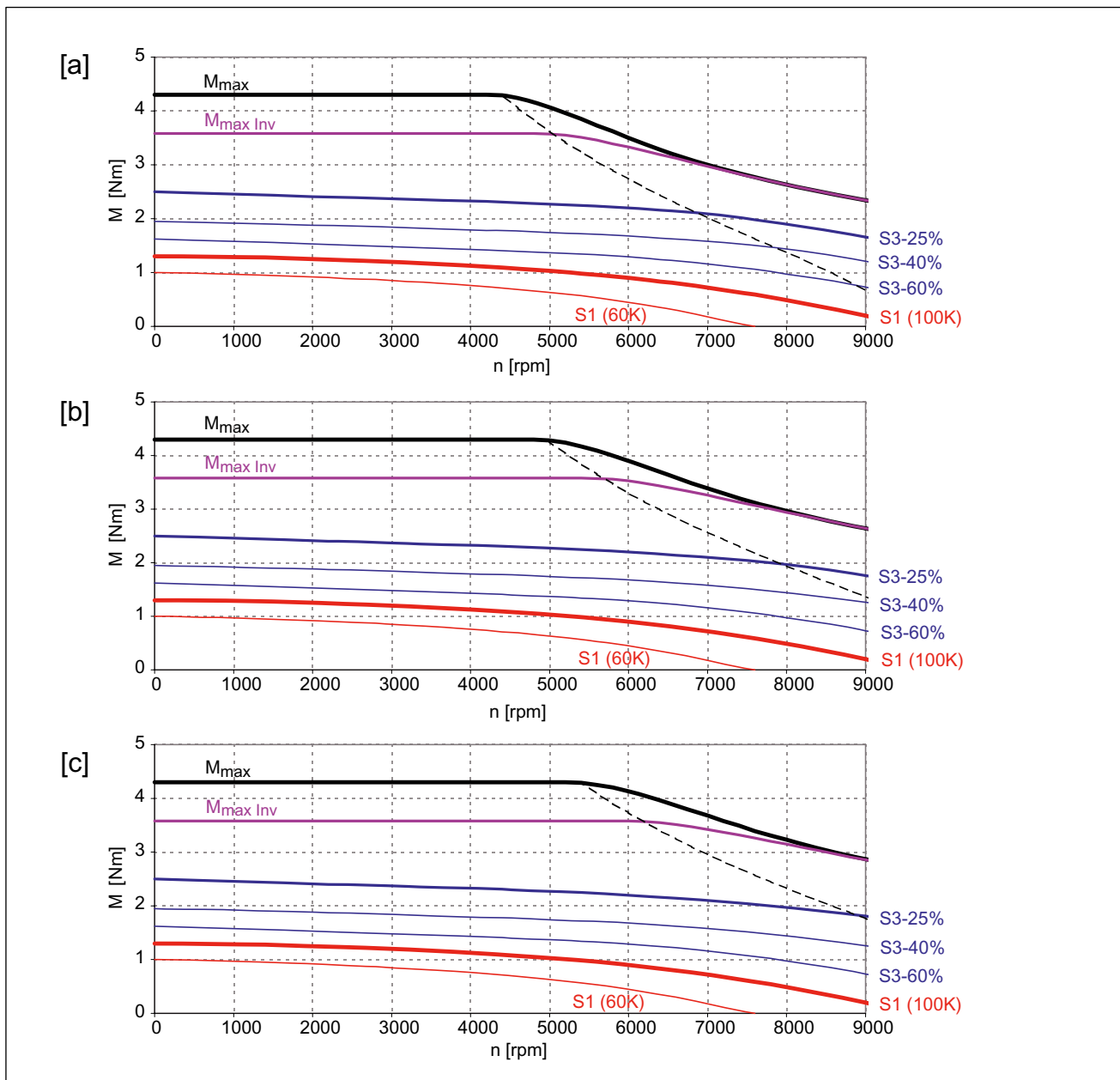

Figure 7-22 1FK7033-7AK71

- [a] SINAMICS SLM 400 V
- [b] SINAMICS ALM 400 V
- [c] SINAMICS SLM 480 V

Table 7-23 1FK7043 HD

Technical data	Code	Unit	-7AH71	
Configuration data				
Rated speed	n_N	RPM	4500	
No. of poles	2p		6	
Rated torque (100 K)	M_N (100 K)	Nm	2,6	
Rated current (100 K)	I_N	A	4,0	
Static torque (60 K)	M_0 (60 K)	Nm	2,5	
Static torque (100 K)	M_0 (100 K)	Nm	3,1	
Stall current (60 K)	I_0 (60 K)	A	3,6	
Stall current (100 K)	I_0 (100 K)	A	4,5	
Moment of inertia (with brake)	J_{MotBr}	10^{-4} kgm ²	1,14	
Moment of inertia (without brake)	J_{Mot}	10^{-4} kgm ²	1,01	
Optimum operating point				
Optimum speed	n_{opt}	RPM	4500	
Optimum power	P_{opt}	kW	1,23	
Limiting data				
Max. permissible speed (mech.)	$n_{max\ mech}$	RPM	8000	
Max. permissible speed (converter)	$n_{max\ Inv}$	RPM	8000	
Max. torque	M_{max}	Nm	9,4	
Max. current	I_{max}	A	14,8	
Physical constants				
Torque constant	k_T	Nm/A	0,67	
Voltage constant	k_E	V/1000 RPM	44	
Winding resistance at 20°C	R_{Str}	Ohm	1,2	
Cyclic inductance	L_D	mH	15	
Electrical time constant	T_{el}	ms	12,5	
Mechanical time constant	T_{mech}	ms	0,81	
Thermal time constant	T_{th}	min	40	
Shaft torsional stiffness	C_t	Nm/rad	11000	
Weight with brake	m_{MotBr}	kg	7,0	
Weight without brake	m_{Mot}	kg	6,3	
Recommended motor module 6SL312_-TE15-0AA_				
Rated current converter	$I_N\ Inv$	A	5	
Max. current converter	$I_{max\ Inv}$	A	10	
Max. torque at $I_{max\ Inv}$	$M_{max\ Inv}$	Nm	6,8	

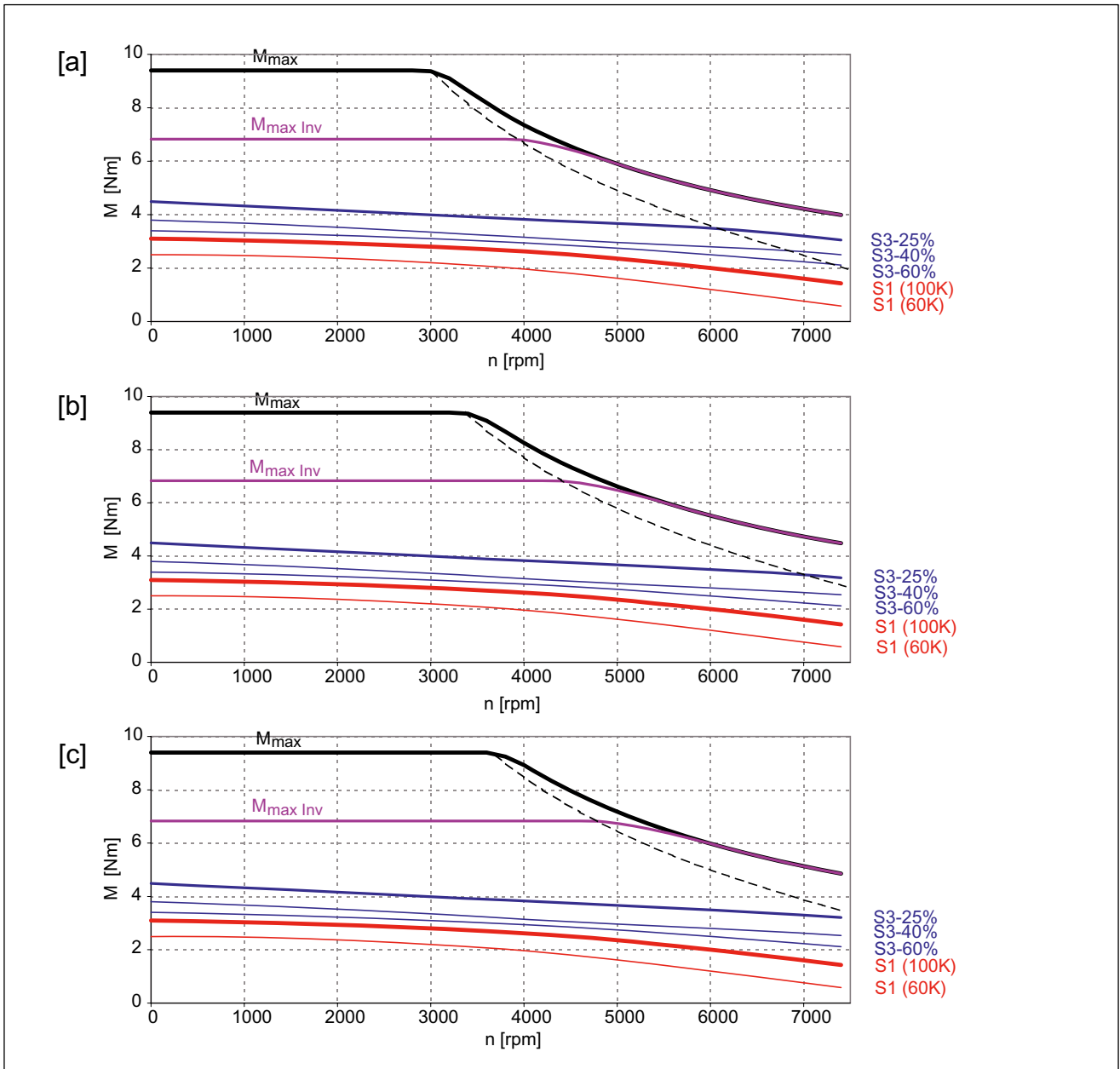

Figure 7-23 1FK7043-7AH71

- [a] SINAMICS SLM 400 V
- [b] SINAMICS ALM 400 V
- [c] SINAMICS SLM 480 V

Table 7-24 1FK7043 HD

Technical data	Code	Unit	-7AK71	
Configuration data				
Rated speed	n_N	RPM	6000	
No. of poles	2p		6	
Rated torque (100 K)	M_N (100 K)	Nm	2	
Rated current (100 K)	I_N	A	4,4	
Static torque (60 K)	M_0 (60 K)	Nm	2,5	
Static torque (100 K)	M_0 (100 K)	Nm	3,1	
Stall current (60 K)	I_0 (60 K)	A	4,8	
Stall current (100 K)	I_0 (100 K)	A	6,4	
Moment of inertia (with brake)	J_{MotBr}	10^{-4} kgm ²	1,14	
Moment of inertia (without brake)	J_{Mot}	10^{-4} kgm ²	1,01	
Optimum operating point				
Optimum speed	n_{opt}	RPM	6000	
Optimum power	P_{opt}	kW	1,26	
Limiting data				
Max. permissible speed (mech.)	$n_{max\ mech}$	RPM	8000	
Max. permissible speed (converter)	$n_{max\ Inv}$	RPM	8000	
Max. torque	M_{max}	Nm	9,4	
Max. current	I_{max}	A	20	
Physical constants				
Torque constant	k_T	Nm/A	0,48	
Voltage constant	k_E	V/1000 RPM	32	
Winding resistance at 20°C	R_{Str}	Ohm	0,65	
Cyclic inductance	L_D	mH	9	
Electrical time constant	T_{el}	ms	13,8	
Mechanical time constant	T_{mech}	ms	0,85	
Thermal time constant	T_{th}	min	40	
Shaft torsional stiffness	C_t	Nm/rad	11000	
Weight with brake	m_{MotBr}	kg	7,0	
Weight without brake	m_{Mot}	kg	6,3	
Recommended motor module 6SL312_-TE15-0AA_				
Rated current converter	$I_N\ Inv$	A	9	
Max. current converter	$I_{max\ Inv}$	A	18	
Max. torque at $I_{max\ Inv}$	$M_{max\ Inv}$	Nm	8,5	

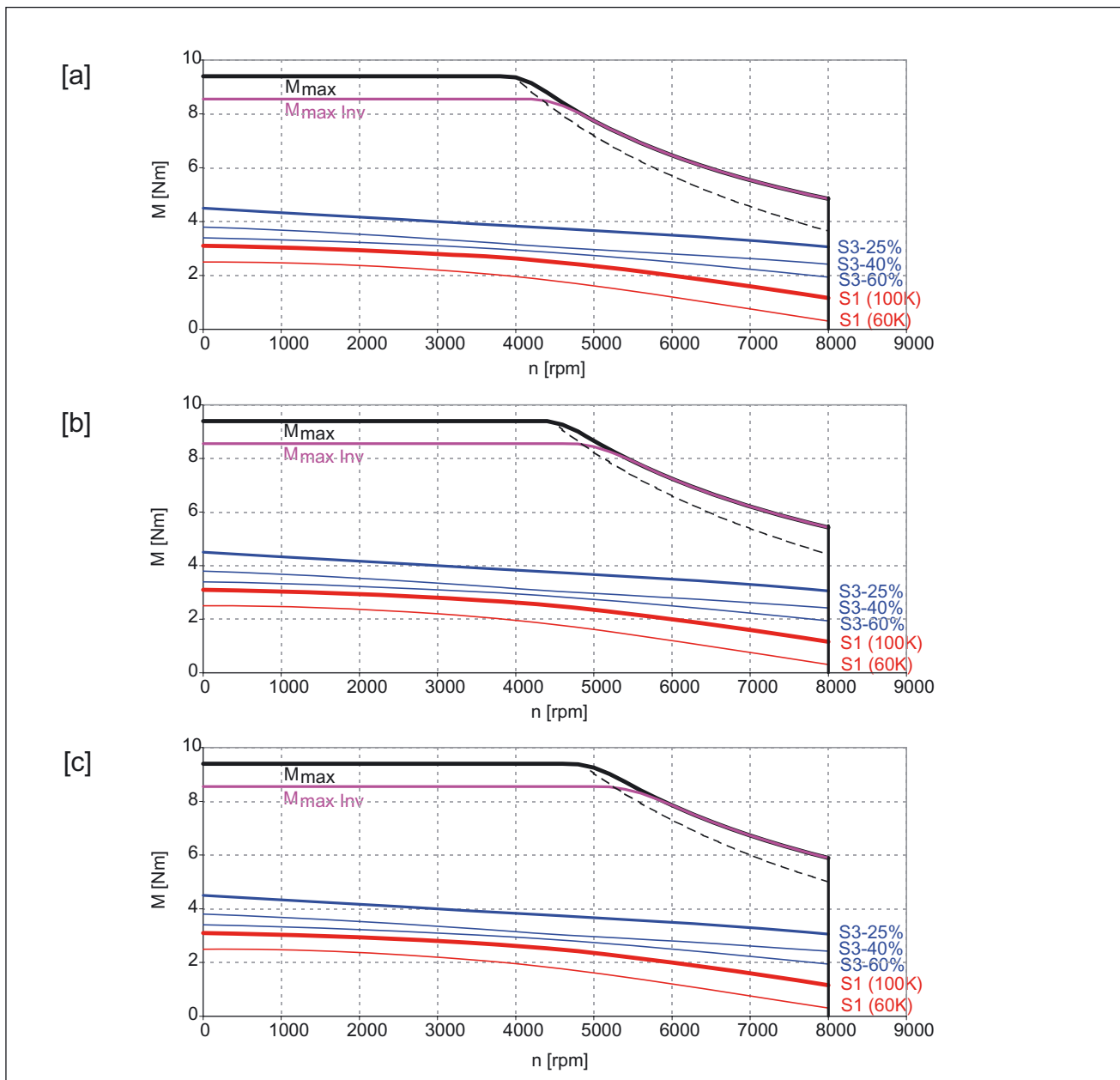

Figure 7-24 1FK7043-7AK71

- [a] SINAMICS SLM 400 V
- [b] SINAMICS ALM 400 V
- [c] SINAMICS SLM 480 V

Table 7-25 1FK7044 HD

Technical data	Code	Unit	-7AF71	
Configuration data				
Rated speed	n_N	RPM	3000	
No. of poles	2p		6	
Rated torque (100 K)	M_N (100 K)	Nm	3,5	
Rated current (100 K)	I_N	A	4,0	
Static torque (60 K)	M_0 (60 K)	Nm	3,0	
Static torque (100 K)	M_0 (100 K)	Nm	4,0	
Stall current (60 K)	I_0 (60 K)	A	3,4	
Stall current (100 K)	I_0 (100 K)	A	4,5	
Moment of inertia (with brake)	J_{MotBr}	10^{-4} kgm ²	1,41	
Moment of inertia (without brake)	J_{Mot}	10^{-4} kgm ²	1,28	
Optimum operating point				
Optimum speed	n_{opt}	RPM	3000	
Optimum power	P_{opt}	kW	1,1	
Limiting data				
Max. permissible speed (mech.)	$n_{max\ mech}$	RPM	8000	
Max. permissible speed (converter)	$n_{max\ Inv}$	RPM	8000	
Max. torque	M_{max}	Nm	12	
Max. current	I_{max}	A	14,8	
Physical constants				
Torque constant	k_T	Nm/A	0,86	
Voltage constant	k_E	V/1000 RPM	57	
Winding resistance at 20°C	R_{Str}	Ohm	1,5	
Cyclic inductance	L_D	mH	20	
Electrical time constant	T_{el}	ms	13,3	
Mechanical time constant	T_{mech}	ms	0,78	
Thermal time constant	T_{th}	min	45	
Shaft torsional stiffness	C_t	Nm/rad	9500	
Weight with brake	m_{MotBr}	kg	8,3	
Weight without brake	m_{Mot}	kg	7,7	
Recommended motor module 6SL312_- _TE15-0AA_				
Rated current converter	$I_N\ Inv$	A	5	
Max. current converter	$I_{max\ Inv}$	A	10	
Max. torque at $I_{max\ Inv}$	$M_{max\ Inv}$	Nm	8,8	

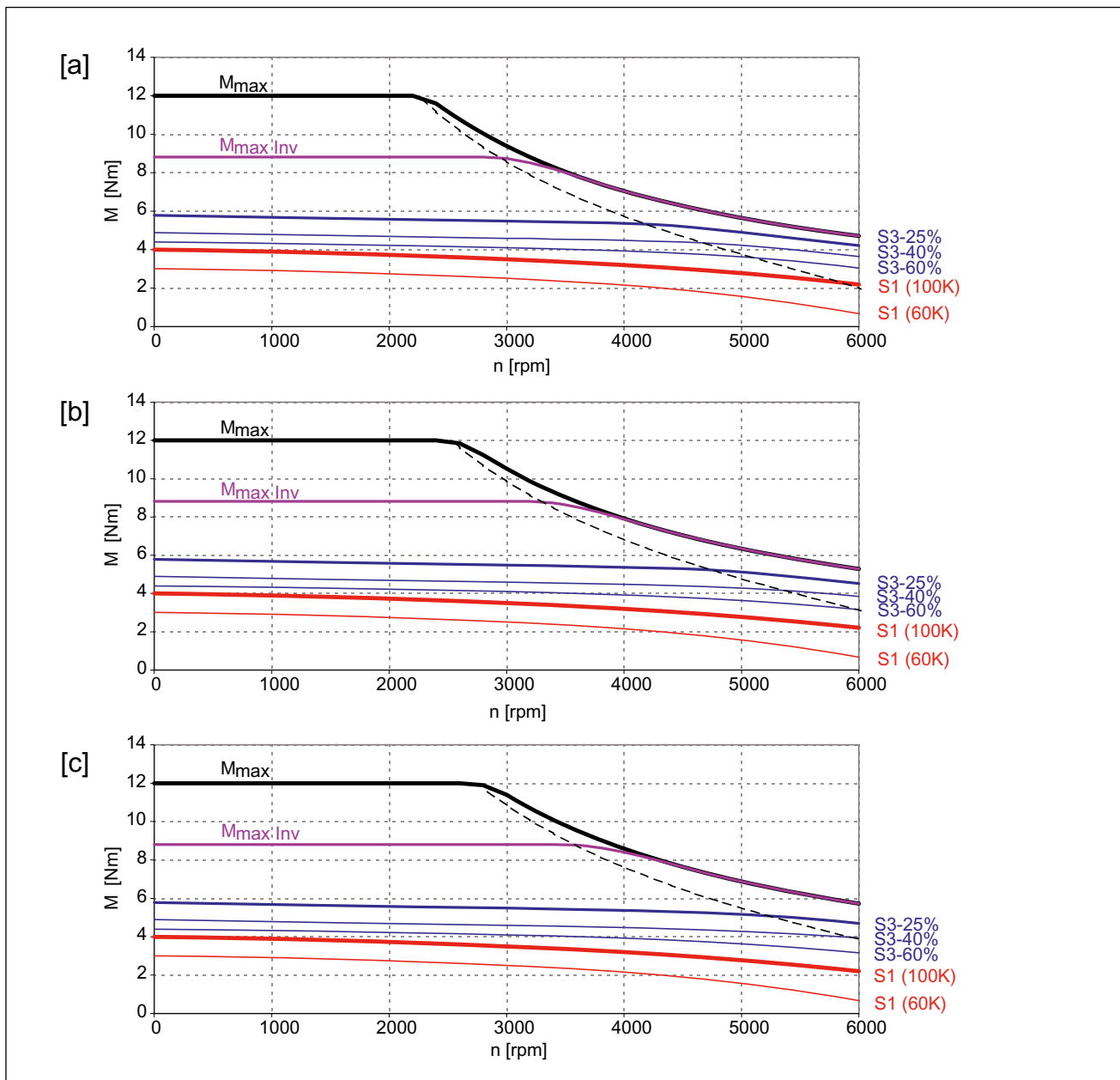

Figure 7-25 1FK7044-7AF71

- [a] SINAMICS SLM 400 V
- [b] SINAMICS ALM 400 V
- [c] SINAMICS SLM 480 V

Table 7-26 1FK7044 HD

Technical data	Code	Unit	-7AH71	
Configuration data				
Rated speed	n_N	RPM	4500	
No. of poles	2p		6	
Rated torque (100 K)	M_N (100 K)	Nm	3,0	
Rated current (100 K)	I_N	A	4,9	
Static torque (60 K)	M_0 (60 K)	Nm	3,0	
Static torque (100 K)	M_0 (100 K)	Nm	4,0	
Stall current (60 K)	I_0 (60 K)	A	4,6	
Stall current (100 K)	I_0 (100 K)	A	6,3	
Moment of inertia (with brake)	J_{MotBr}	10^{-4} kgm ²	1,41	
Moment of inertia (without brake)	J_{Mot}	10^{-4} kgm ²	1,28	
Optimum operating point				
Optimum speed	n_{opt}	RPM	4500	
Optimum power	P_{opt}	kW	1,41	
Limiting data				
Max. permissible speed (mech.)	$n_{max\ mech}$	RPM	8000	
Max. permissible speed (converter)	$n_{max\ Inv}$	RPM	8000	
Max. torque	M_{max}	Nm	12	
Max. current	I_{max}	A	20	
Physical constants				
Torque constant	k_T	Nm/A	0,63	
Voltage constant	k_E	V/1000 RPM	42	
Winding resistance at 20°C	R_{Str}	Ohm	0,81	
Cyclic inductance	L_D	mH	11	
Electrical time constant	T_{el}	ms	13,5	
Mechanical time constant	T_{mech}	ms	0,78	
Thermal time constant	T_{th}	min	45	
Shaft torsional stiffness	C_t	Nm/rad	9500	
Weight with brake	m_{MotBr}	kg	8,3	
Weight without brake	m_{Mot}	kg	7,7	
Recommended motor module 6SL312_-TE21-0AA_				
Rated current converter	$I_N\ Inv$	A	9	
Max. current converter	$I_{max\ Inv}$	A	18	
Max. torque at $I_{max\ Inv}$	$M_{max\ Inv}$	Nm	11	

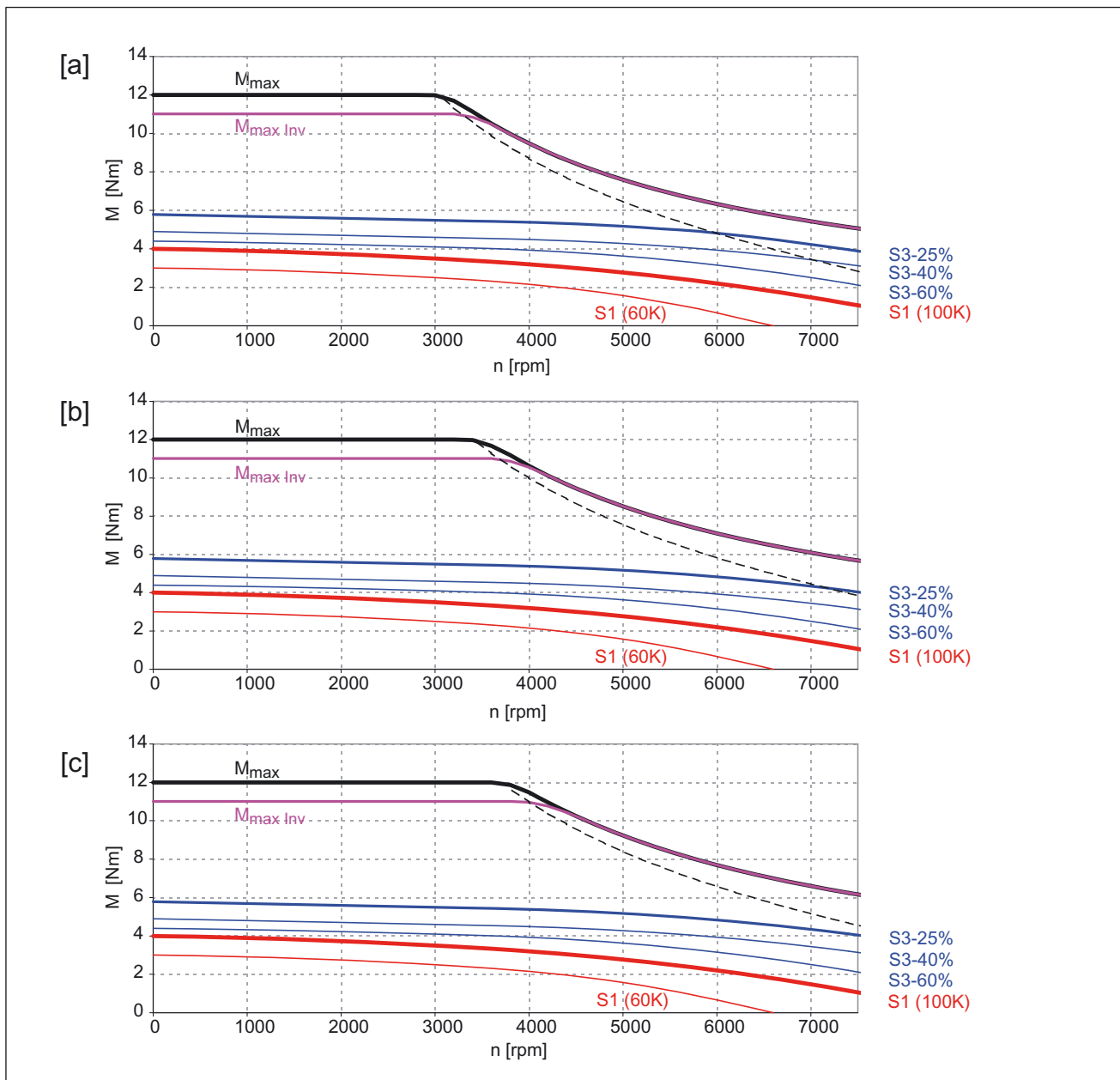

Figure 7-26 1FK7044-7AH71

- [a] SINAMICS SLM 400 V
- [b] SINAMICS ALM 400 V
- [c] SINAMICS SLM 480 V

Table 7-27 1FK7061 HD

Technical data	Code	Unit	-7AF71	
Configuration data				
Rated speed	n_N	RPM	3000	
No. of poles	2p		6	
Rated torque (100 K)	$M_N (100 K)$	Nm	5.4	
Rated current (100 K)	I_N	A	5.3	
Static torque (60 K)	$M_0 (60 K)$	Nm	4.9	
Static torque (100 K)	$M_0 (100 K)$	Nm	6.4	
Stall current (60 K)	$I_0 (60 K)$	A	4.8	
Stall current (100 K)	$I_0 (100 K)$	A	6.1	
Moment of inertia (with brake)	J_{MotBr}	10^{-4} kgm ²	3.74	
Moment of inertia (without brake)	J_{Mot}	10^{-4} kgm ²	3.4	
Optimum operating point				
Optimum speed	n_{opt}	RPM	3000	
Optimum power	P_{opt}	kW	1.7	
Limiting data				
Max. permissible speed (mech.)	$n_{max mech}$	RPM	6000	
Max. permissible speed (converter)	$n_{max Inv}$	RPM	6000	
Max. torque	M_{max}	Nm	17.3	
Max. current	I_{max}	A	17.5	
Physical constants				
Torque constant	k_T	Nm/A	1.0	
Voltage constant	k_E	V/1000 RPM	66	
Winding resistance at 20°C	R_{Str}	Ohm	0.74	
Cyclic inductance	L_D	mH	20	
Electrical time constant	T_{el}	ms	27	
Mechanical time constant	T_{mech}	ms	0.75	
Thermal time constant	T_{th}	min	45	
Shaft torsional stiffness	C_t	Nm/rad	37000	
Weight with brake	m_{MotBr}	kg	11.2	
Weight without brake	m_{Mot}	kg	10	
Recommended motor module 6SL312_- TE21-0AA_				
Rated current converter	$I_N Inv$	A	9	
Max. current converter	$I_{max Inv}$	A	18	
Max. torque at $I_{max Inv}$	$M_{max Inv}$	Nm	17.3 (= M_{max})	

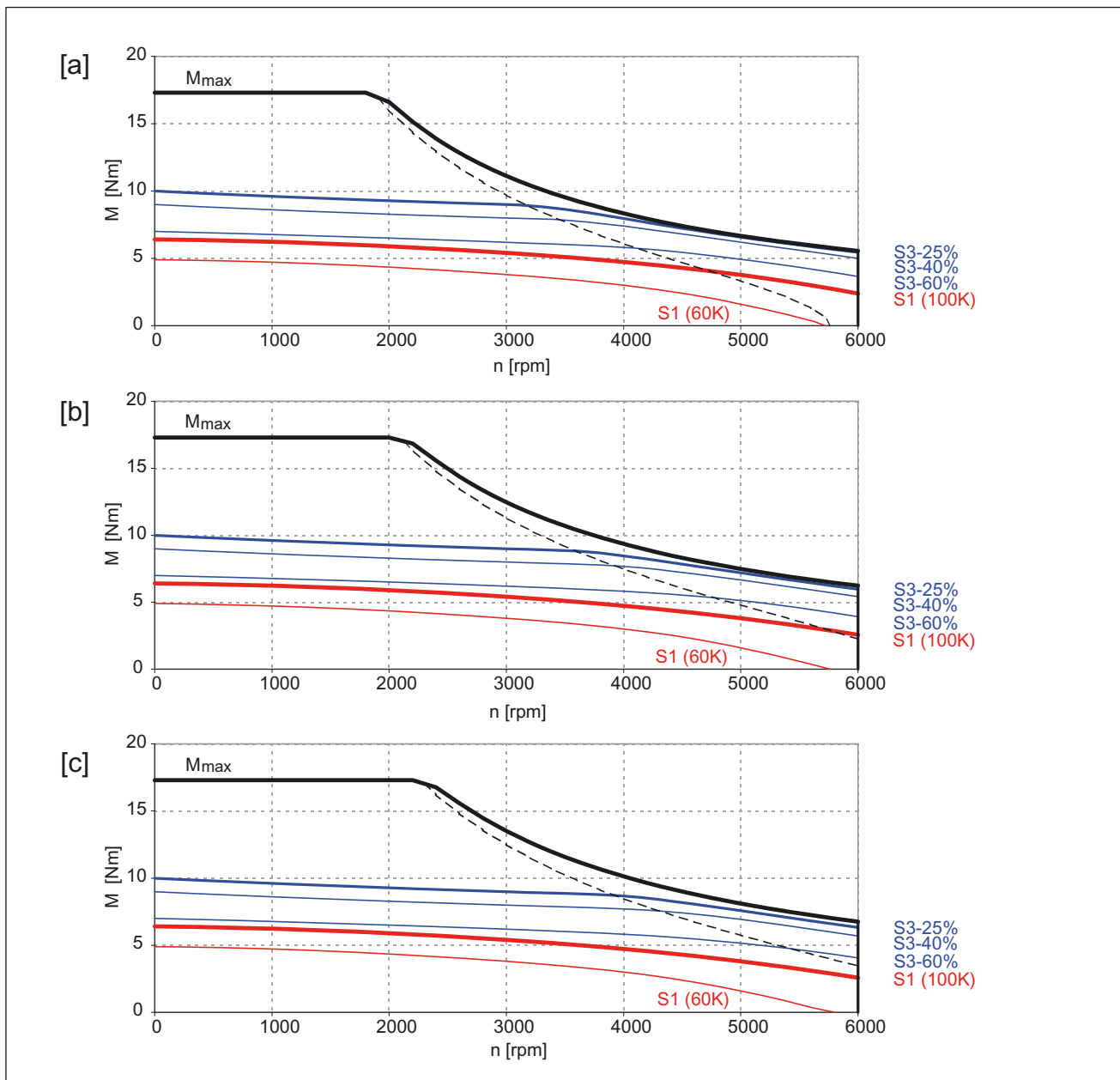

Figure 7-27 1FK7061-7AF71

- [a] SINAMICS SLM 400 V
- [b] SINAMICS ALM 400 V
- [c] SINAMICS SLM 480 V

Table 7-28 1FK7061 HD

Technical data	Code	Unit	-7AH71	
Configuration data				
Rated speed	n_N	RPM	4500	
No. of poles	2p		6	
Rated torque (100 K)	$M_N (100 K)$	Nm	4.3	
Rated current (100 K)	I_N	A	5.9	
Static torque (60 K)	$M_0 (60 K)$	Nm	4.9	
Static torque (100 K)	$M_0 (100 K)$	Nm	6.4	
Stall current (60 K)	$I_0 (60 K)$	A	7.0	
Stall current (100 K)	$I_0 (100 K)$	A	8.0	
Moment of inertia (with brake)	J_{MotBr}	10^{-4} kgm ²	3.74	
Moment of inertia (without brake)	J_{Mot}	10^{-4} kgm ²	3.4	
Optimum operating point				
Optimum speed	n_{opt}	RPM	4500	
Optimum power	P_{opt}	kW	2.03	
Limiting data				
Max. permissible speed (mech.)	$n_{max mech}$	RPM	6000	
Max. permissible speed (converter)	$n_{max Inv}$	RPM	6000	
Max. torque	M_{max}	Nm	17.3	
Max. current	I_{max}	A	25.3	
Physical constants				
Torque constant	k_T	Nm/A	0.7	
Voltage constant	k_E	V/1000 RPM	46	
Winding resistance at 20°C	R_{Str}	Ohm	0.36	
Cyclic inductance	L_D	mH	9.6	
Electrical time constant	T_{el}	ms	27	
Mechanical time constant	T_{mech}	ms	0.75	
Thermal time constant	T_{th}	min	45	
Shaft torsional stiffness	C_t	Nm/rad	37000	
Weight with brake	m_{MotBr}	kg	11.2	
Weight without brake	m_{Mot}	kg	10	
Recommended motor module 6SL312_- TE21-0AA_				
Rated current converter	$I_N Inv$	A	9	
Max. current converter	$I_{max Inv}$	A	18	
Max. torque at $I_{max Inv}$	$M_{max Inv}$	Nm	14.1	

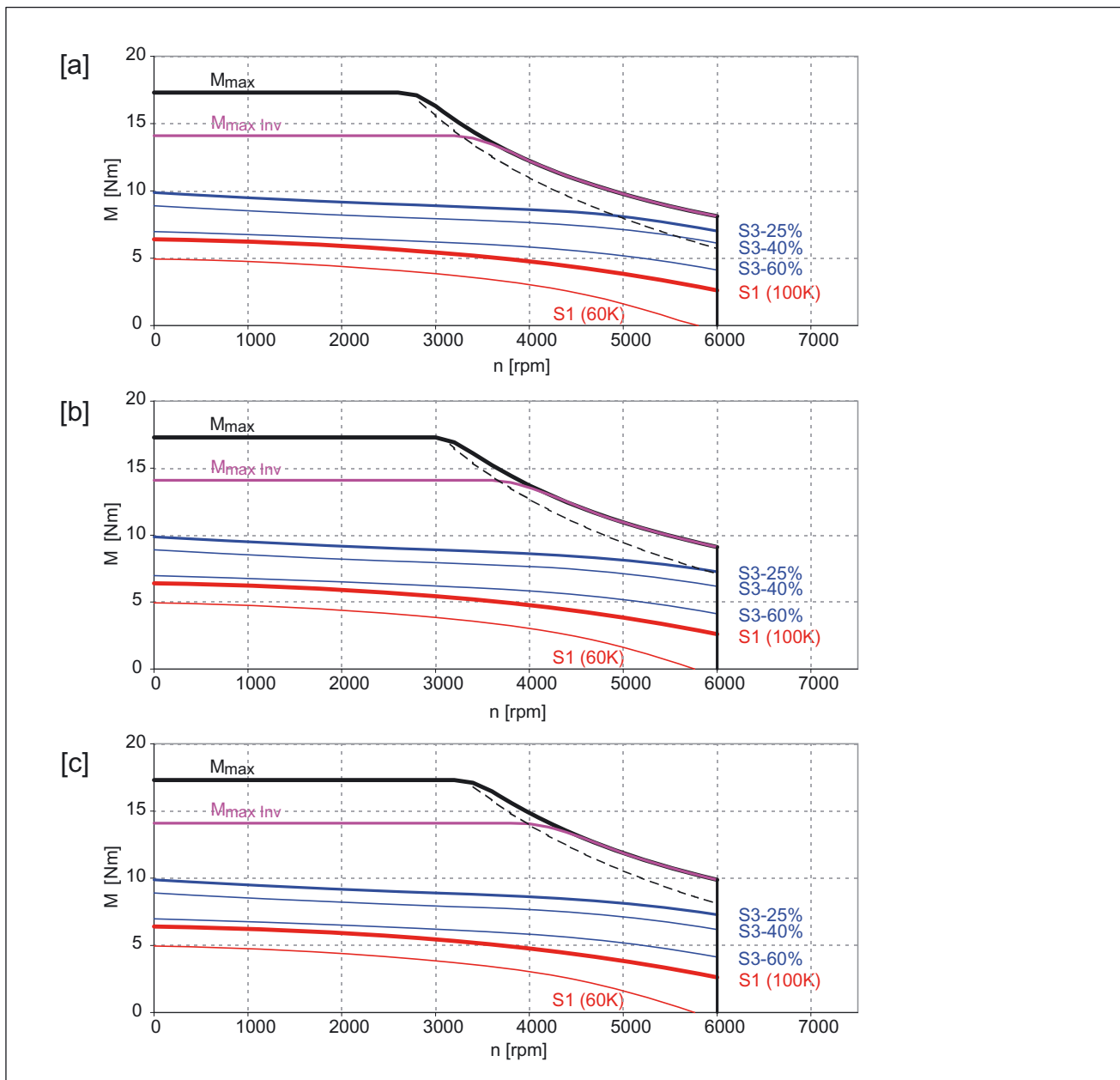

Figure 7-28 1FK7061-7AH71

- [a] SINAMICS SLM 400 V
- [b] SINAMICS ALM 400 V
- [c] SINAMICS SLM 480 V

Table 7-29 1FK7064 HD

Technical data	Code	Unit	-7AF71	
Configuration data				
Rated speed	n_N	RPM	3000	
No. of poles	2p		6	
Rated torque (100 K)	M_N (100 K)	Nm	8.0	
Rated current (100 K)	I_N	A	7.5	
Static torque (60 K)	M_0 (60 K)	Nm	9.0	
Static torque (100 K)	M_0 (100 K)	Nm	12	
Stall current (60 K)	I_0 (60 K)	A	8.5	
Stall current (100 K)	I_0 (100 K)	A	11	
Moment of inertia (with brake)	J_{MotBr}	10^{-4} kgm ²	6.84	
Moment of inertia (without brake)	J_{Mot}	10^{-4} kgm ²	6.5	
Optimum operating point				
Optimum speed	n_{opt}	RPM	3000	
Optimum power	P_{opt}	kW	2.51	
Limiting data				
Max. permissible speed (mech.)	$n_{max\ mech}$	RPM	6000	
Max. permissible speed (converter)	$n_{max\ Inv}$	RPM	6000	
Max. torque	M_{max}	Nm	32	
Max. current	I_{max}	A	31	
Physical constants				
Torque constant	k_T	Nm/A	1.03	
Voltage constant	k_E	V/1000 RPM	68	
Winding resistance at 20°C	R_{Str}	Ohm	0.35	
Cyclic inductance	L_D	mH	10.7	
Electrical time constant	T_{el}	ms	30.5	
Mechanical time constant	T_{mech}	ms	0.64	
Thermal time constant	T_{th}	min	55	
Shaft torsional stiffness	C_t	Nm/rad	30000	
Weight with brake	m_{MotBr}	kg	16.8	
Weight without brake	m_{Mot}	kg	15.5	
Recommended motor module 6SL312_-TE21-8AA_				
Rated current converter	$I_N\ Inv$	A	18	
Max. current converter	$I_{max\ Inv}$	A	36	
Max. torque at $I_{max\ Inv}$	$M_{max\ Inv}$	Nm	32 (with I_{max})	

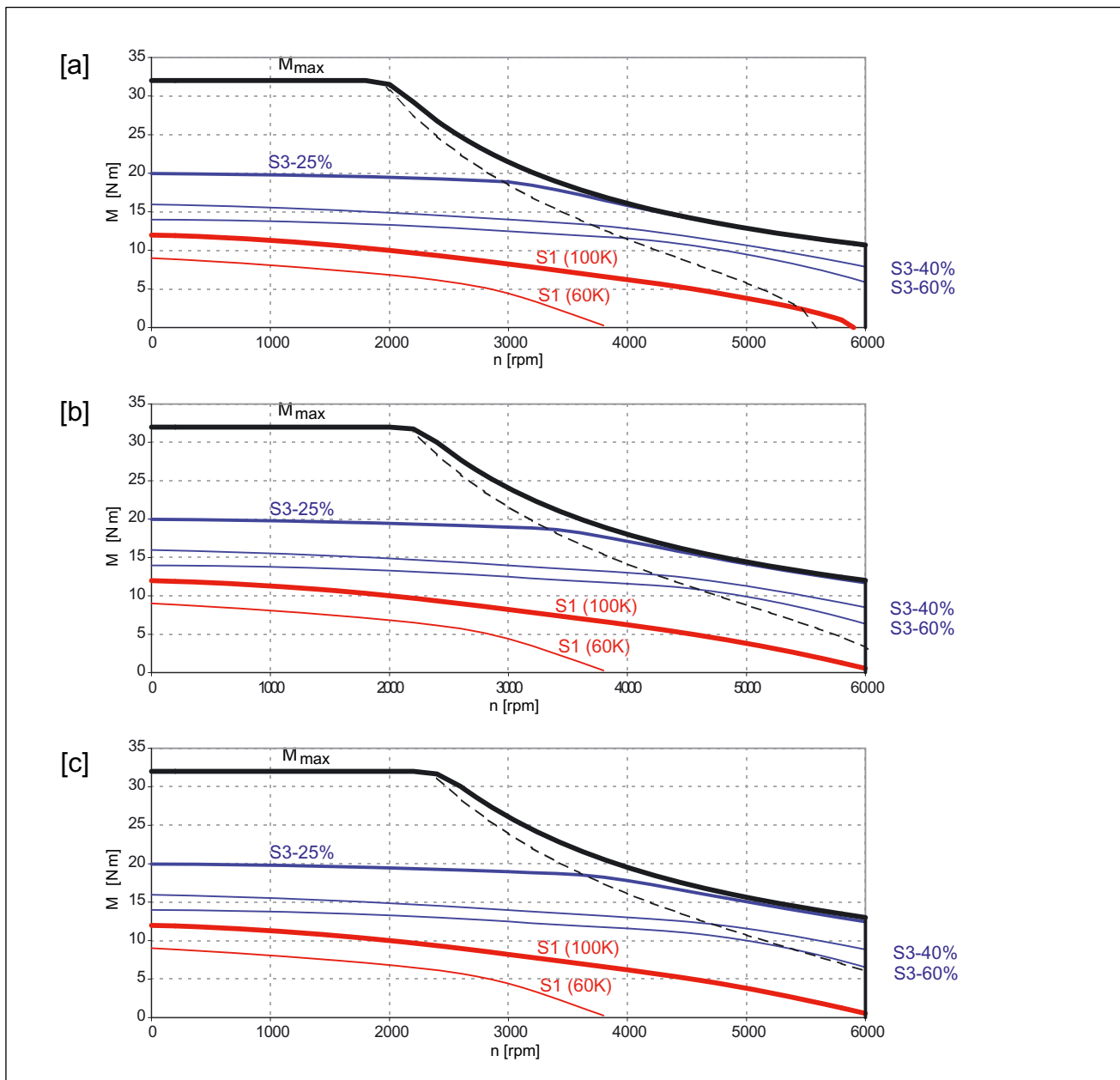

Figure 7-29 1FK7064-7AF71

- [a] SINAMICS SLM 400 V
- [b] SINAMICS ALM 400 V
- [c] SINAMICS SLM 480 V

Table 7-30 1FK7064 HD

Technical data	Code	Unit	-7AH71	
Configuration data				
Rated speed	n_N	RPM	4500	
No. of poles	2p		6	
Rated torque (100 K)	M_N (100 K)	Nm	5.0	
Rated current (100 K)	I_N	A	7.0	
Static torque (60 K)	M_0 (60 K)	Nm	9.0	
Static torque (100 K)	M_0 (100 K)	Nm	12	
Stall current (60 K)	I_0 (60 K)	A	12	
Stall current (100 K)	I_0 (100 K)	A	15	
Moment of inertia (with brake)	J_{MotBr}	10^{-4} kgm ²	6.84	
Moment of inertia (without brake)	J_{Mot}	10^{-4} kgm ²	6.5	
Optimum operating point				
Optimum speed	n_{opt}	RPM	3500	
Optimum power	P_{opt}	kW	2.75	
Limiting data				
Max. permissible speed (mech.)	$n_{max\ mech}$	RPM	6000	
Max. permissible speed (converter)	$n_{max\ Inv}$	RPM	6000	
Max. torque	M_{max}	Nm	32	
Max. current	I_{max}	A	42	
Physical constants				
Torque constant	k_T	Nm/A	0.77	
Voltage constant	k_E	V/1000 RPM	51	
Winding resistance at 20°C	R_{Str}	Ohm	0.18	
Cyclic inductance	L_D	mH	5.6	
Electrical time constant	T_{el}	ms	31.1	
Mechanical time constant	T_{mech}	ms	0.59	
Thermal time constant	T_{th}	min	55	
Shaft torsional stiffness	C_t	Nm/rad	30000	
Weight with brake	m_{MotBr}	kg	16.8	
Weight without brake	m_{Mot}	kg	15.5	
Recommended motor module 6SL312_-TE21-8AA_				
Rated current converter	$I_N\ Inv$	A	18	
Max. current converter	$I_{max\ Inv}$	A	36	
Max. torque at $I_{max\ Inv}$	$M_{max\ Inv}$	Nm	28.2	

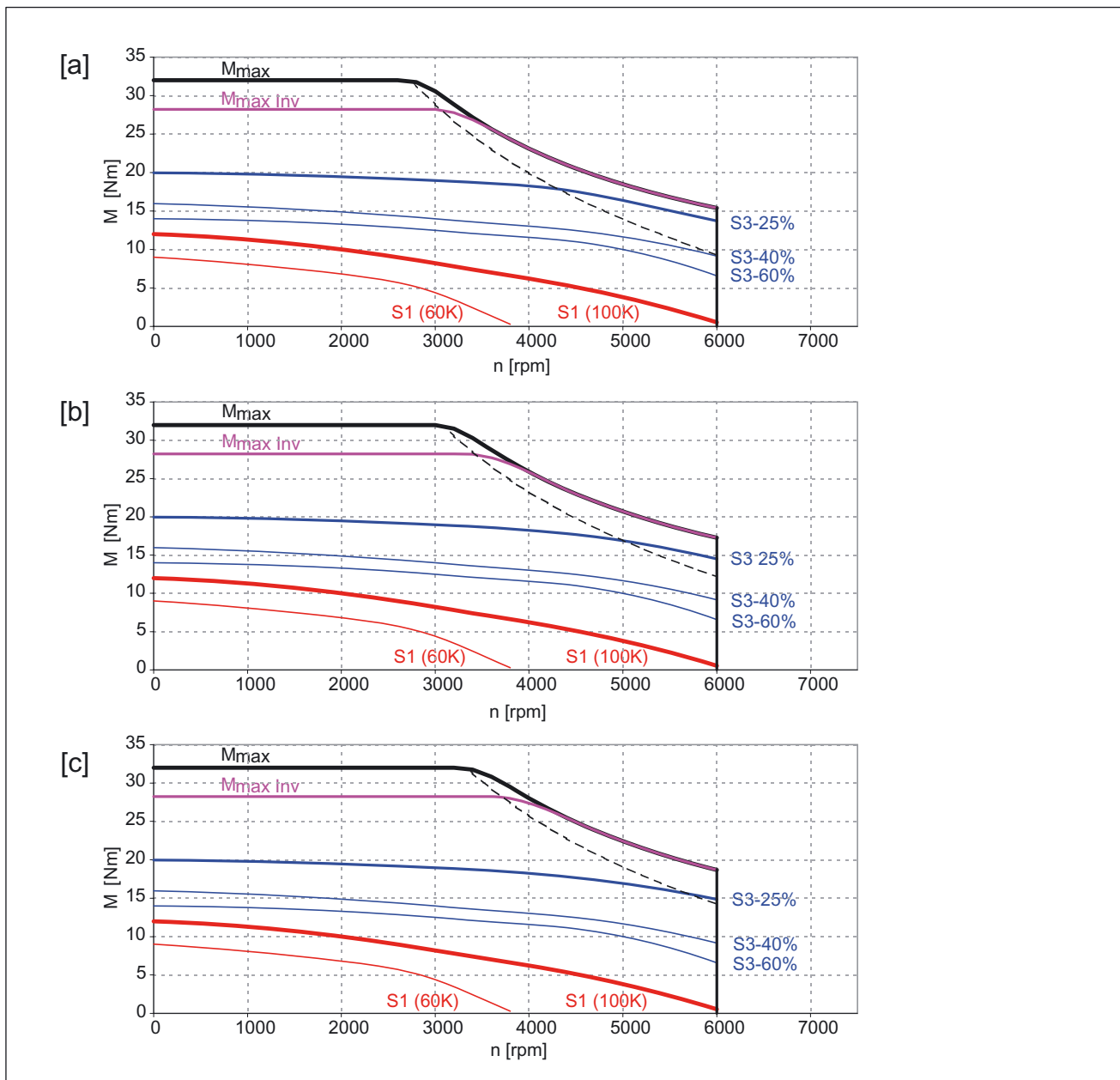

Figure 7-30 1FK7064-7AH71

- [a] SINAMICS SLM 400 V
- [b] SINAMICS ALM 400 V
- [c] SINAMICS SLM 480 V

Table 7-31 1FK7085 HD

Technical data	Code	Unit	-7AF71	
Configuration data				
Rated speed	n_N	RPM	3000	
No. of poles	2p		8	
Rated torque (100 K)	M_N (100 K)	Nm	6.5	
Rated current (100 K)	I_N	A	7.0	
Static torque (60 K)	M_0 (60 K)	Nm	17	
Static torque (100 K)	M_0 (100 K)	Nm	22	
Stall current (60 K)	I_0 (60 K)	A	16.5	
Stall current (100 K)	I_0 (100 K)	A	22.5	
Moment of inertia (with brake)	J_{MotBr}	10^{-4} kgm ²	25	
Moment of inertia (without brake)	J_{Mot}	10^{-4} kgm ²	23	
Optimum operating point				
Optimum speed	n_{opt}	RPM	2500	
Optimum power	P_{opt}	kW	3.14	
Limiting data				
Max. permissible speed (mech.)	$n_{max\ mech}$	RPM	6000	
Max. permissible speed (converter)	$n_{max\ Inv}$	RPM	6000	
Max. torque	M_{max}	Nm	65	
Max. current	I_{max}	A	80	
Physical constants				
Torque constant	k_T	Nm/A	0.96	
Voltage constant	k_E	V/1000 RPM	63	
Winding resistance at 20°C	R_{Str}	Ohm	0.12	
Cyclic inductance	L_D	mH	3.3	
Electrical time constant	T_{el}	ms	27.5	
Mechanical time constant	T_{mech}	ms	0.9	
Thermal time constant	T_{th}	min	65	
Shaft torsional stiffness	C_t	Nm/rad	83000	
Weight with brake	m_{MotBr}	kg	25.7	
Weight without brake	m_{Mot}	kg	23.5	
Recommended motor module 6SL312_- _TE23-0AA_				
Rated current converter	$I_N\ Inv$	A	30	
Max. current converter	$I_{max\ Inv}$	A	56	
Max. torque at $I_{max\ Inv}$	$M_{max\ Inv}$	Nm	52.6	

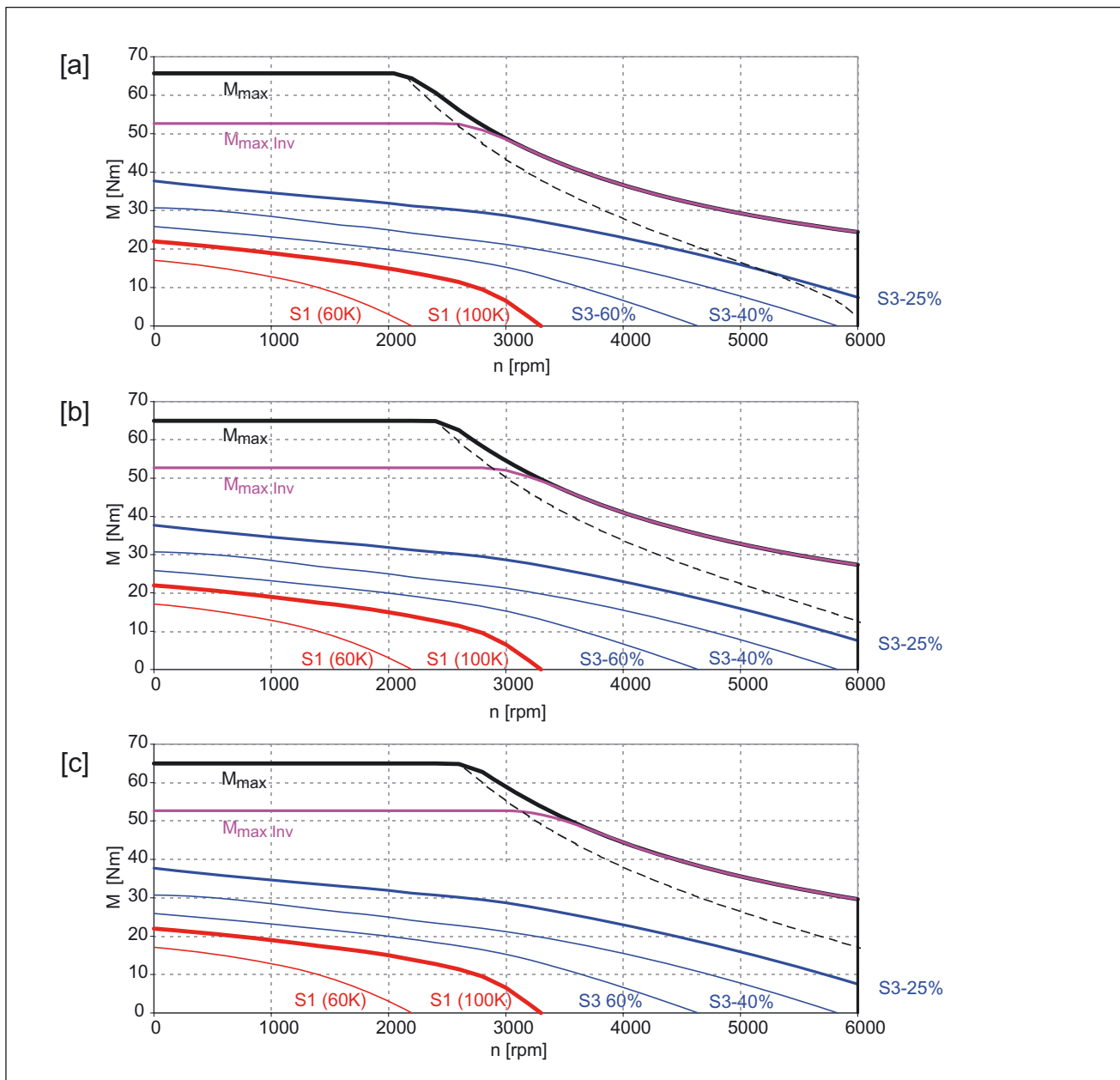

Figure 7-31 1FK7085-7AF71

- [a] SINAMICS SLM 400 V
- [b] SINAMICS ALM 400 V
- [c] SINAMICS SLM 480 V

Table 7-32 1FK7086 HD

Technical data	Code	Unit	-7AF71	
Configuration data				
Rated speed	n_N	RPM	3000	
No. of poles	2p		8	
Rated torque (100 K)	M_N (100 K)	Nm	6.5	
Rated current (100 K)	I_N	A	5.5	
Static torque (60 K)	M_0 (60 K)	Nm	23.5	
Static torque (100 K)	M_0 (100 K)	Nm	28	
Stall current (60 K)	I_0 (60 K)	A	17	
Stall current (100 K)	I_0 (100 K)	A	21	
Moment of inertia (with brake)	J_{MotBr}	10^{-4} kgm ²	25	
Moment of inertia (without brake)	J_{Mot}	10^{-4} kgm ²	23	
Optimum operating point				
Optimum speed	n_{opt}	RPM	2000	
Optimum power	P_{opt}	kW	3.77	
Limiting data				
Max. permissible speed (mech.)	$n_{max\ mech}$	RPM	6000	
Max. permissible speed (converter)	$n_{max\ Inv}$	RPM	6000	
Max. torque	M_{max}	Nm	105	
Max. current	I_{max}	A	112	
Physical constants				
Torque constant	k_T	Nm/A	1.33	
Voltage constant	k_E	V/1000 RPM	85	
Winding resistance at 20°C	R_{Str}	Ohm	0.12	
Cyclic inductance	L_D	mH	3	
Electrical time constant	T_{el}	ms	25	
Mechanical time constant	T_{mech}	ms	0.47	
Thermal time constant	T_{th}	min	65	
Shaft torsional stiffness	C_t	Nm/rad	83000	
Weight with brake	m_{MotBr}	kg	25.7	
Weight without brake	m_{Mot}	kg	23.5	
Recommended motor module 6SL312_- _TE23-0AA_				
Rated current converter	$I_N\ Inv$	A	30	
Max. current converter	$I_{max\ Inv}$	A	56	
Max. torque at $I_{max\ Inv}$	$M_{max\ Inv}$	Nm	72	

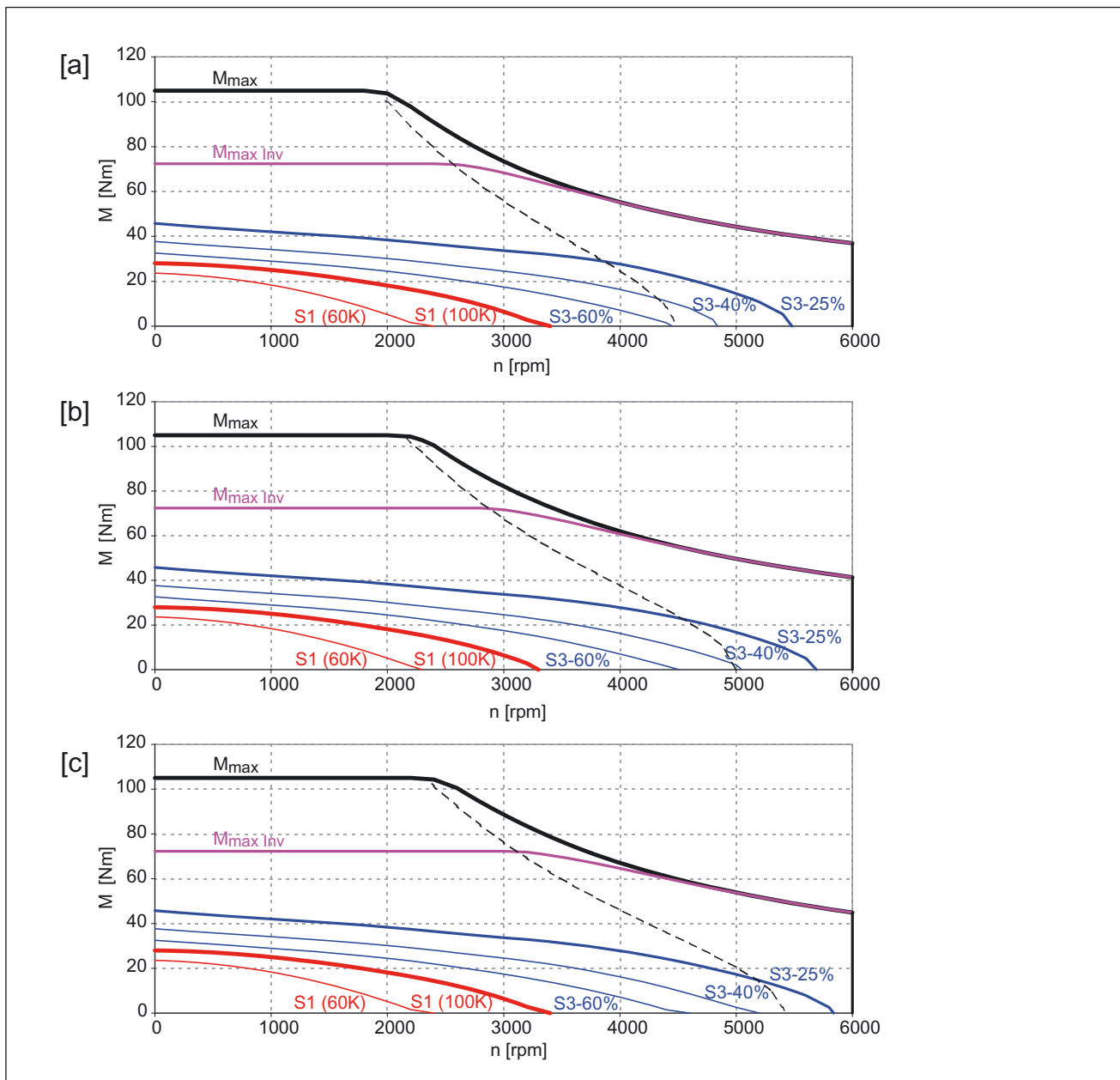

Figure 7-32 1FK7086-7AF71

- [a] SINAMICS SLM 400 V
- [b] SINAMICS ALM 400 V
- [c] SINAMICS SLM 480 V

7.3 1FK7 motors on SINAMICS S120 Power Module with 1 AC 230 V power supply

Table 7-33 1FK7011

Technical data	Code	Unit	-5AK21	
Configuration data				
Rated speed	n_N	RPM	6000	
No. of poles	2p		8	
Rated torque (100 K)	M_N (100 K)	Nm	0.08	
Rated current (100 K)	I_N	A	0.5	
Static torque (60 K)	M_0 (60 K)	Nm	0.15	
Static torque (100 K)	M_0 (100 K)	Nm	0.18	
Stall current (60 K)	I_0 (60 K)	A	0.7	
Stall current (100 K)	I_0 (100 K)	A	0.85	
Moment of inertia (with brake)	J_{MotBr}	10^{-4} kgm ²	0.083	
Moment of inertia (without brake)	J_{Mot}	10^{-4} kgm ²	0.064	
Optimum operating point				
Optimum speed	n_{opt}	RPM	5000	
Optimum power	P_{opt}	kW	0.06	
Limiting data				
Max. permissible speed (mech.)	$n_{max\ mech}$	RPM	8000	
Max. permissible speed (converter)	$n_{max\ Inv}$	RPM	8000	
Max. torque	M_{max}	Nm	0.5	
Max. current	I_{max}	A	2.4	
Physical constants				
Torque constant	k_T	Nm/A	0.21	
Voltage constant	k_E	V/1000 RPM	14	
Winding resistance at 20°C	R_{Str}	Ohm	9.4	
Cyclic inductance	L_D	mH	13	
Electrical time constant	T_{el}	ms	1.4	
Mechanical time constant	T_{mech}	ms	4.1	
Thermal time constant	T_{th}	min	14	
Shaft torsional stiffness	C_t	Nm/rad	1400	
Weight with brake	m_{MotBr}	kg	1.0	
Weight without brake	m_{Mot}	kg	0.9	
Recommended power module 6SL3210-1SB11-0UA0				
Rated current converter	$I_{N\ Inv}$	A	0.9	
Max. current converter	$I_{max\ Inv}$	A	1.8	
Max. torque at $I_{max\ Inv}$	$M_{max\ Inv}$	Nm	0.37	

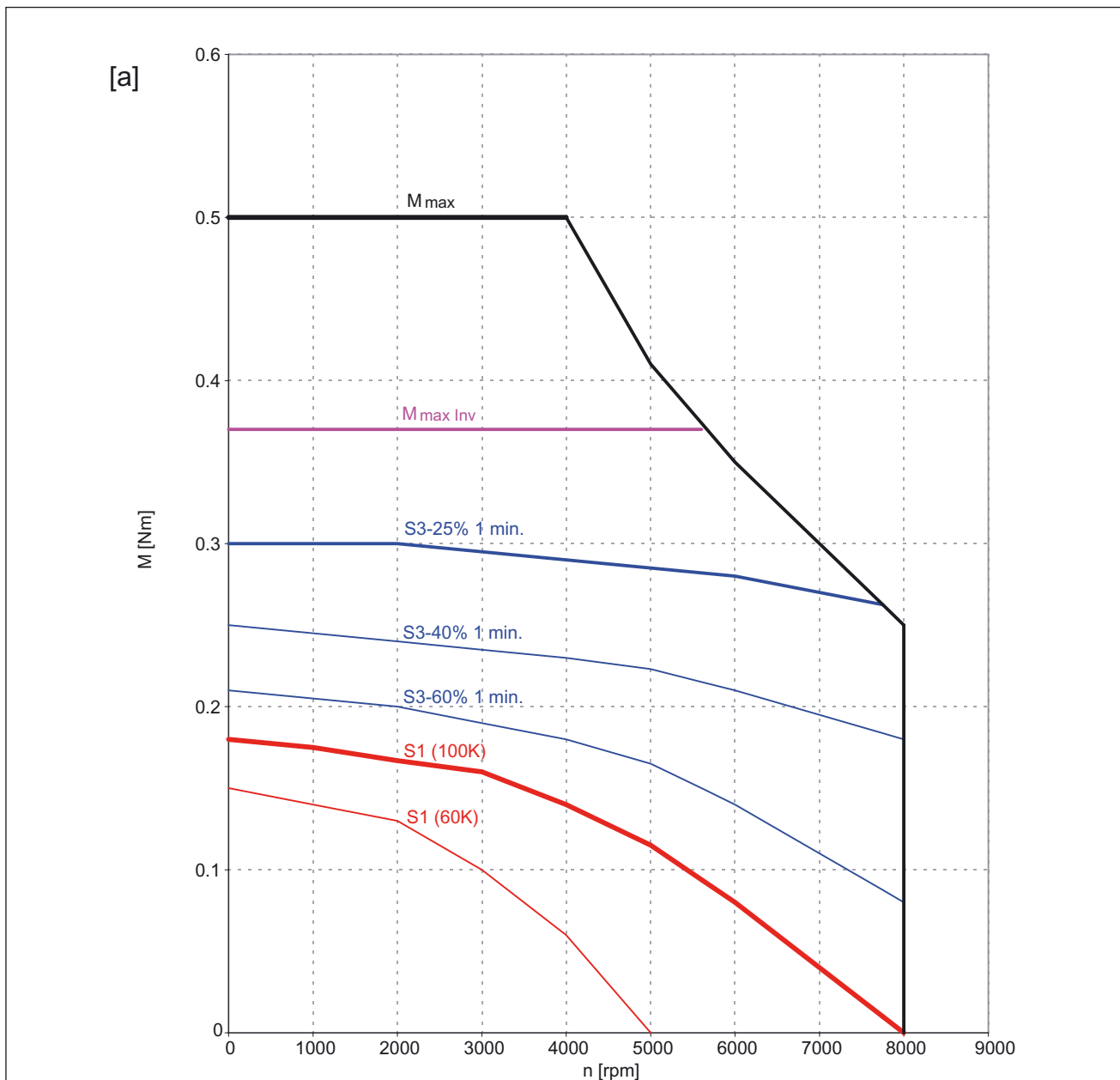

Figure 7-33 1FK7011-5AK21

[a] SINAMICS 1AC 230 V

Table 7-34 1FK7015

Technical data	Code	Unit	-5AK21	
Configuration data				
Rated speed	n_N	RPM	6000	
No. of poles	2p		8	
Rated torque (100 K)	M_N (100 K)	Nm	0.16	
Rated current (100 K)	I_N	A	0.5	
Static torque (60 K)	M_0 (60 K)	Nm	0.29	
Static torque (100 K)	M_0 (100 K)	Nm	0.35	
Stall current (60 K)	I_0 (60 K)	A	0.7	
Stall current (100 K)	I_0 (100 K)	A	0.85	
Moment of inertia (with brake)	J_{MotBr}	10^{-4} kgm ²	0.102	
Moment of inertia (without brake)	J_{Mot}	10^{-4} kgm ²	0.083	
Optimum operating point				
Optimum speed	n_{opt}	RPM	5000	
Optimum power	P_{opt}	kW	0.12	
Limiting data				
Max. permissible speed (mech.)	$n_{max\ mech}$	RPM	8000	
Max. permissible speed (converter)	$n_{max\ Inv}$	RPM	8000	
Max. torque	M_{max}	Nm	1	
Max. current	I_{max}	A	2.4	
Physical constants				
Torque constant	k_T	Nm/A	0.42	
Voltage constant	k_E	V/1000 RPM	28	
Winding resistance at 20°C	R_{Str}	Ohm	13.6	
Cyclic inductance	L_D	mH	26	
Electrical time constant	T_{el}	ms	1.9	
Mechanical time constant	T_{mech}	ms	1.9	
Thermal time constant	T_{th}	min	16	
Shaft torsional stiffness	C_t	Nm/rad	1300	
Weight with brake	m_{MotBr}	kg	1.2	
Weight without brake	m_{Mot}	kg	1.2	
Recommended power module 6SL3210-1SB11-0UA0				
Rated current converter	$I_N\ Inv$	A	0.9	
Max. current converter	$I_{max\ Inv}$	A	1.8	
Max. torque at $I_{max\ Inv}$	$M_{max\ Inv}$	Nm	0.75	

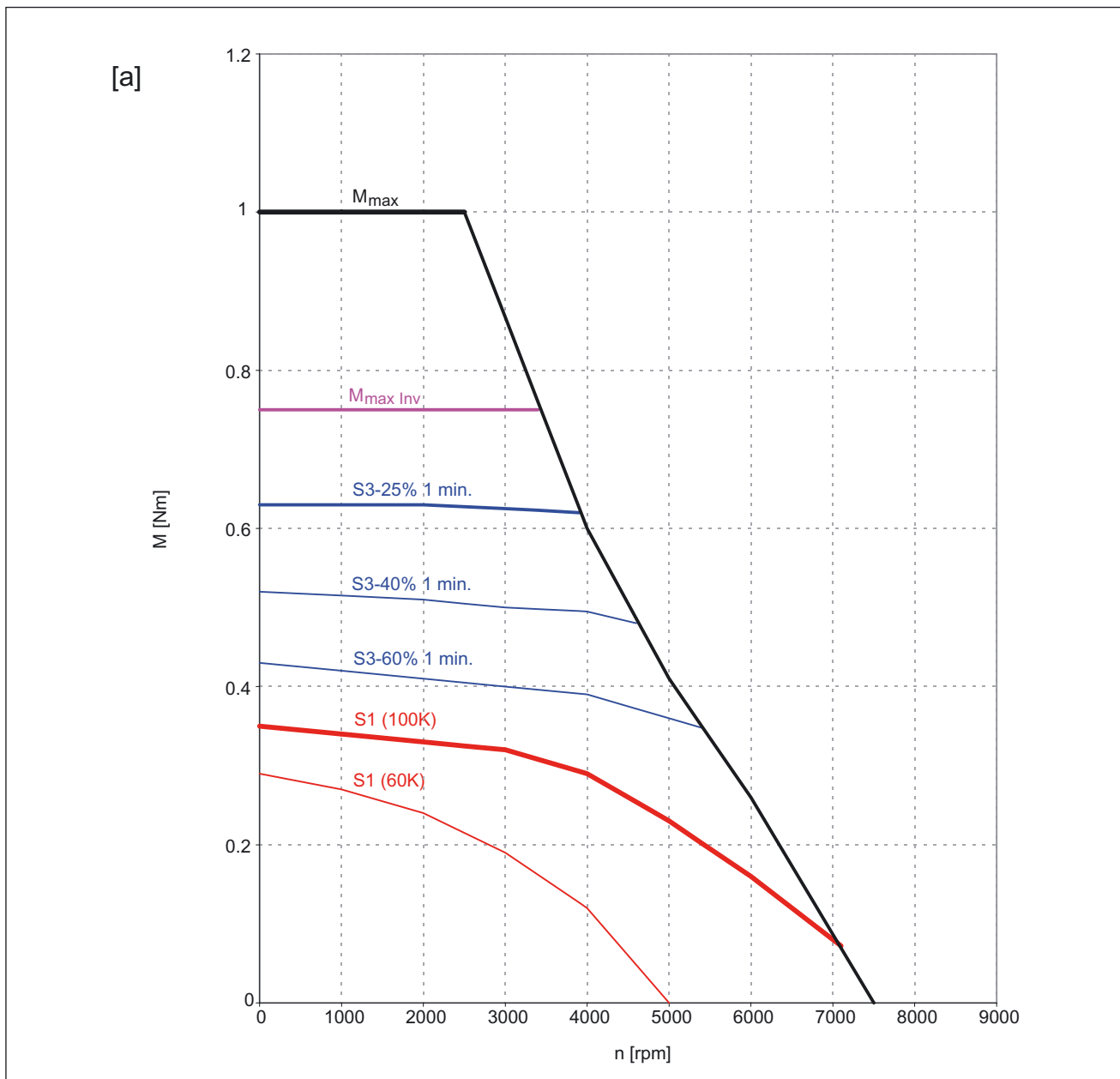

Figure 7-34 1FK7015-5AK21

[a] SINAMICS 1AC 230 V

Table 7-35 1FK7022

Technical data	Code	Unit	-5AK21	
Configuration data				
Rated speed	n_N	RPM	6000	
No. of poles	2p		6	
Rated torque (100 K)	M_N (100 K)	Nm	0.6	
Rated current (100 K)	I_N	A	1.4	
Static torque (60 K)	M_0 (60 K)	Nm	0.7	
Static torque (100 K)	M_0 (100 K)	Nm	0.85	
Stall current (60 K)	I_0 (60 K)	A	1.5	
Stall current (100 K)	I_0 (100 K)	A	1.8	
Moment of inertia (with brake)	J_{MotBr}	10^{-4} kgm ²	0.35	
Moment of inertia (without brake)	J_{Mot}	10^{-4} kgm ²	0.28	
Optimum operating point				
Optimum speed	n_{opt}	RPM	6000	
Optimum power	P_{opt}	kW	0.38	
Limiting data				
Max. permissible speed (mech.)	$n_{max\ mech}$	RPM	10000	
Max. permissible speed (converter)	$n_{max\ Inv}$	RPM	9990	
Max. torque	M_{max}	Nm	3.4	
Max. current	I_{max}	A	8.0	
Physical constants				
Torque constant	k_T	Nm/A	0.46	
Voltage constant	k_E	V/1000 RPM	29	
Winding resistance at 20°C	R_{Str}	Ohm	4.2	
Cyclic inductance	L_D	mH	9.1	
Electrical time constant	T_{el}	ms	2.2	
Mechanical time constant	T_{mech}	ms	1.7	
Thermal time constant	T_{th}	min	18	
Shaft torsional stiffness	C_t	Nm/rad	3000	
Weight with brake	m_{MotBr}	kg	2.0	
Weight without brake	m_{Mot}	kg	1.8	
Recommended power module 6SL3210-1SB12-3UA0				
Rated current converter	$I_N\ Inv$	A	2.3	
Max. current converter	$I_{max\ Inv}$	A	4.6	
Max. torque at $I_{max\ Inv}$	$M_{max\ Inv}$	Nm	2.0	

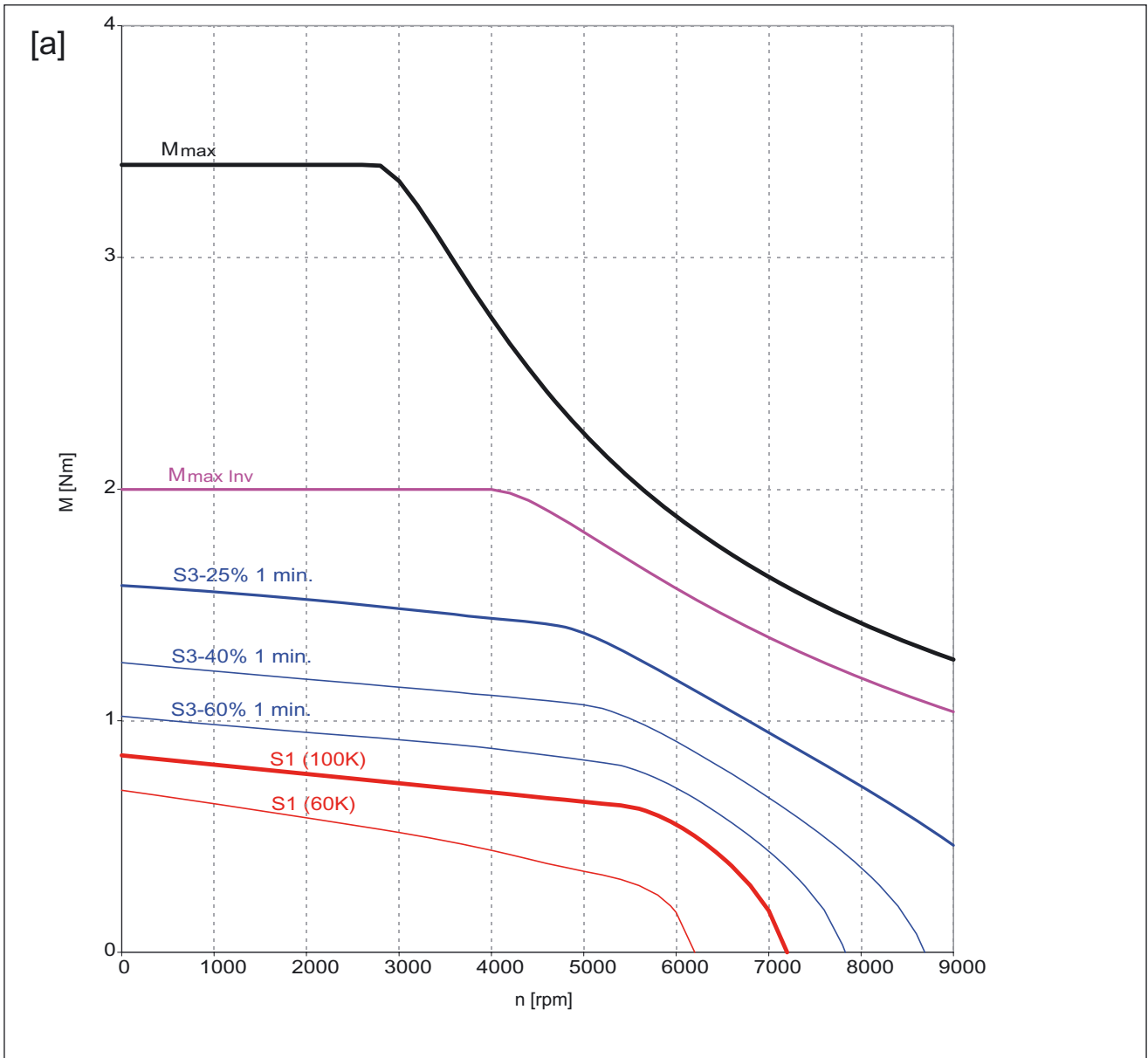

Figure 7-35 1FK7022-5AK21

[a] SINAMICS 1AC 230 V

Table 7-36 1FK7032

Technical data	Code	Unit	-5AF21	
Configuration data				
Rated speed	n_N	RPM	3000	
No. of poles	2p		6	
Rated torque (100 K)	M_N (100 K)	Nm	1	
Rated current (100 K)	I_N	A	1.6	
Static torque (60 K)	M_0 (60 K)	Nm	0.85	
Static torque (100 K)	M_0 (100 K)	Nm	1.15	
Stall current (60 K)	I_0 (60 K)	A	1.4	
Stall current (100 K)	I_0 (100 K)	A	1.7	
Moment of inertia (with brake)	J_{MotBr}	10^{-4} kgm ²	0.69	
Moment of inertia (without brake)	J_{Mot}	10^{-4} kgm ²	0.61	
Optimum operating point				
Optimum speed	n_{opt}	RPM	3000	
Optimum power	P_{opt}	kW	0.31	
Limiting data				
Max. permissible speed (mech.)	$n_{max\ mech}$	RPM	10000	
Max. permissible speed (converter)	$n_{max\ Inv}$	RPM	6440	
Max. torque	M_{max}	Nm	4.5	
Max. current	I_{max}	A	7	
Physical constants				
Torque constant	k_T	Nm/A	0.67	
Voltage constant	k_E	V/1000 RPM	45	
Winding resistance at 20°C	R_{Str}	Ohm	5.2	
Cyclic inductance	L_D	mH	18.5	
Electrical time constant	T_{el}	ms	3.6	
Mechanical time constant	T_{mech}	ms	2.2	
Thermal time constant	T_{th}	min	25	
Shaft torsional stiffness	C_t	Nm/rad	6500	
Weight with brake	m_{MotBr}	kg	3	
Weight without brake	m_{Mot}	kg	2.7	
Recommended power module 6SL3210-1SB12-3UA0				
Rated current converter	$I_N\ Inv$	A	2.3	
Max. current converter	$I_{max\ Inv}$	A	4.6	
Max. torque at $I_{max\ Inv}$	$M_{max\ Inv}$	Nm	3	

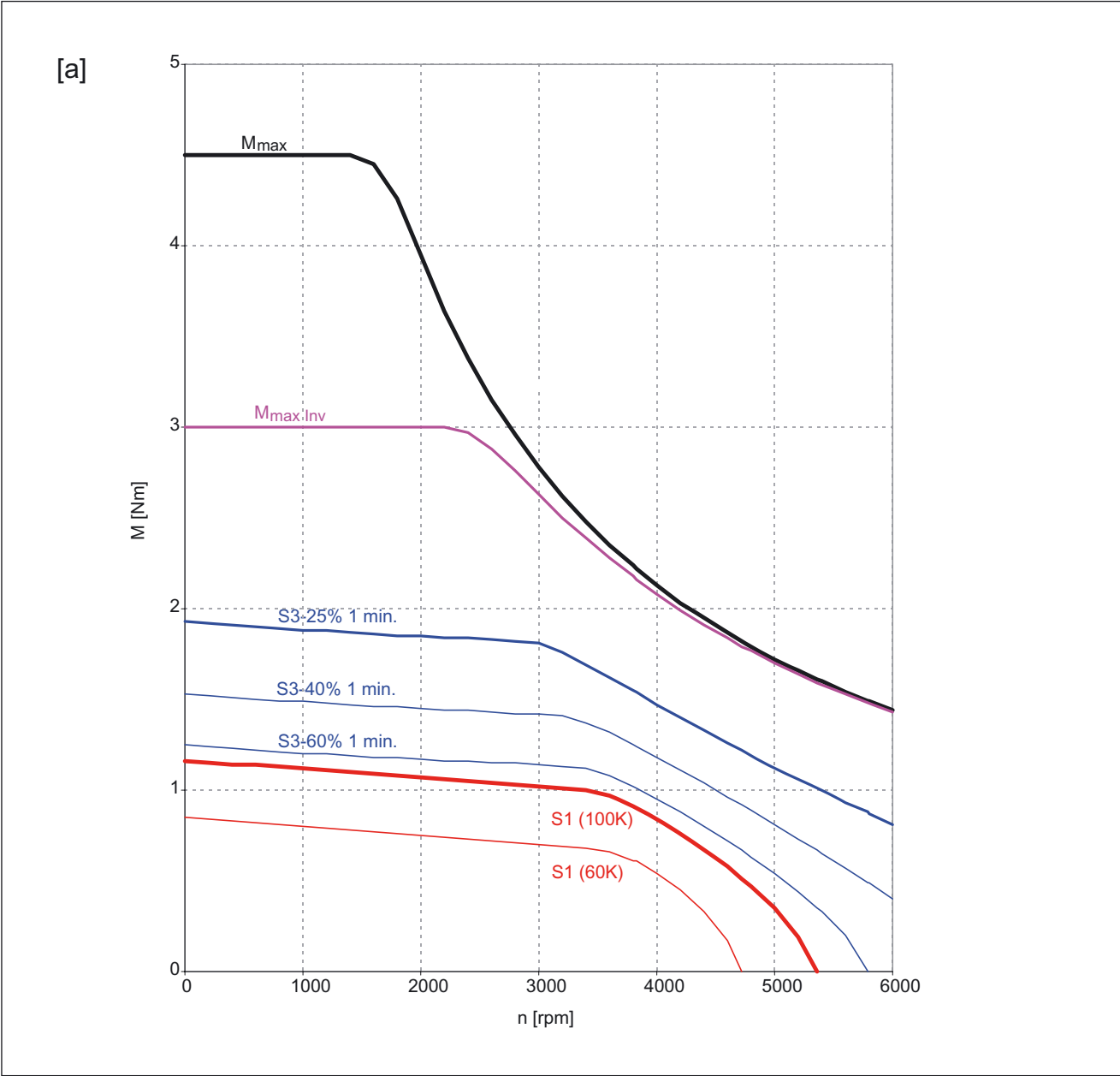

Figure 7-36 1FK7032-5AF21

[a] SINAMICS 1AC 230 V

Table 7-37 1FK7033

Technical data	Code	Unit	-7AF21	
Configuration data				
Rated speed	n_N	RPM	3000	
No. of poles	2p		6	
Rated torque (100 K)	M_N (100 K)	Nm	1.2	
Rated current (100 K)	I_N	A	2	
Static torque (60 K)	M_0 (60 K)	Nm	1	
Static torque (100 K)	M_0 (100 K)	Nm	1.3	
Stall current (60 K)	I_0 (60 K)	A	1.7	
Stall current (100 K)	I_0 (100 K)	A	2.2	
Moment of inertia (with brake)	J_{MotBr}	10^{-4} kgm ²	0.3	
Moment of inertia (without brake)	J_{Mot}	10^{-4} kgm ²	0.27	
Optimum operating point				
Optimum speed	n_{opt}	RPM	3000	
Optimum power	P_{opt}	kW	0.38	
Limiting data				
Max. permissible speed (mech.)	$n_{max\ mech}$	RPM	10000	
Max. permissible speed (converter)	$n_{max\ Inv}$	RPM	7240	
Max. torque	M_{max}	Nm	4.3	
Max. current	I_{max}	A	7.2	
Physical constants				
Torque constant	k_T	Nm/A	0.6	
Voltage constant	k_E	V/1000 RPM	40	
Winding resistance at 20°C	R_{Str}	Ohm	3.7	
Cyclic inductance	L_D	mH	18	
Electrical time constant	T_{el}	ms	4.9	
Mechanical time constant	T_{mech}	ms	0.83	
Thermal time constant	T_{th}	min	25	
Shaft torsional stiffness	C_t	Nm/rad	8000	
Weight with brake	m_{MotBr}	kg	3.4	
Weight without brake	m_{Mot}	kg	3.1	
Recommended power module 6SL3210-1SB12-3UA0				
Rated current converter	$I_N\ Inv$	A	2.3	
Max. current converter	$I_{max\ Inv}$	A	4.6	
Max. torque at $I_{max\ Inv}$	$M_{max\ Inv}$	Nm	2.7	

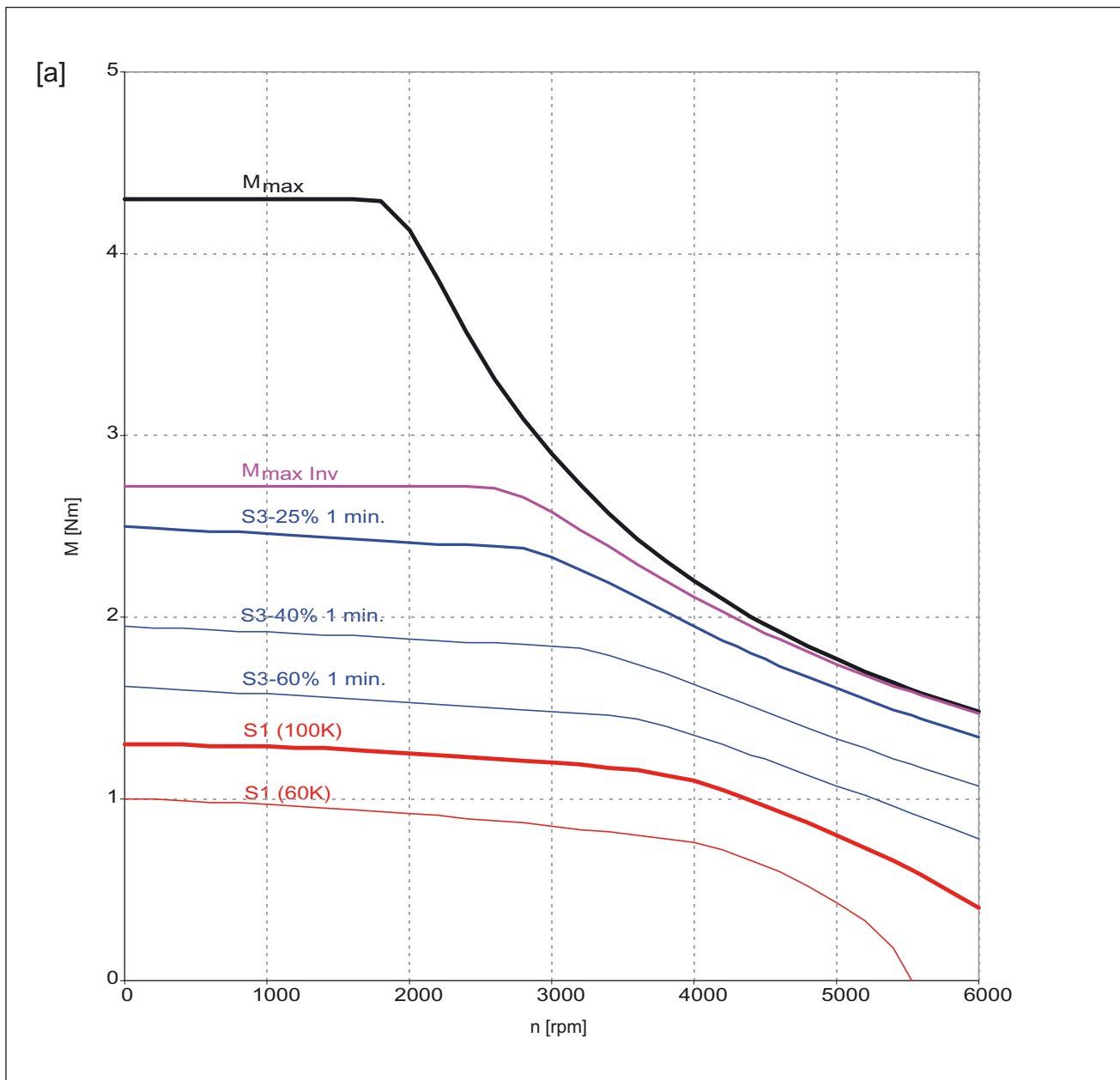

Figure 7-37 1FK7033-7AF21

[a] SINAMICS 1AC 230 V

Table 7-38 1FK7034

Technical data	Code	Unit	-5AF21	
Configuration data				
Rated speed	n_N	RPM	3000	
No. of poles	2p		6	
Rated torque (100 K)	M_N (100 K)	Nm	1.45	
Rated current (100 K)	I_N	A	1.8	
Static torque (60 K)	M_0 (60 K)	Nm	1.35	
Static torque (100 K)	M_0 (100 K)	Nm	1.6	
Stall current (60 K)	I_0 (60 K)	A	1.6	
Stall current (100 K)	I_0 (100 K)	A	1.9	
Moment of inertia (with brake)	J_{MotBr}	10^{-4} kgm ²	0.98	
Moment of inertia (without brake)	J_{Mot}	10^{-4} kgm ²	0.9	
Optimum operating point				
Optimum speed	n_{opt}	RPM	3000	
Optimum power	P_{opt}	kW	0.46	
Limiting data				
Max. permissible speed (mech.)	$n_{max\ mech}$	RPM	10000	
Max. permissible speed (converter)	$n_{max\ Inv}$	RPM	5270	
Max. torque	M_{max}	Nm	6.5	
Max. current	I_{max}	A	8	
Physical constants				
Torque constant	k_T	Nm/A	0.86	
Voltage constant	k_E	V/1000 RPM	55	
Winding resistance at 20°C	R_{Str}	Ohm	4.5	
Cyclic inductance	L_D	mH	16.5	
Electrical time constant	T_{el}	ms	3.7	
Mechanical time constant	T_{mech}	ms	1.6	
Thermal time constant	T_{th}	min	30	
Shaft torsional stiffness	C_t	Nm/rad	5500	
Weight with brake	m_{MotBr}	kg	4.0	
Weight without brake	m_{Mot}	kg	3.7	
Recommended power module 6SL3210-1SB12-3UA0				
Rated current converter	$I_N\ Inv$	A	2.3	
Max. current converter	$I_{max\ Inv}$	A	4.6	
Max. torque at $I_{max\ Inv}$	$M_{max\ Inv}$	Nm	3.9	

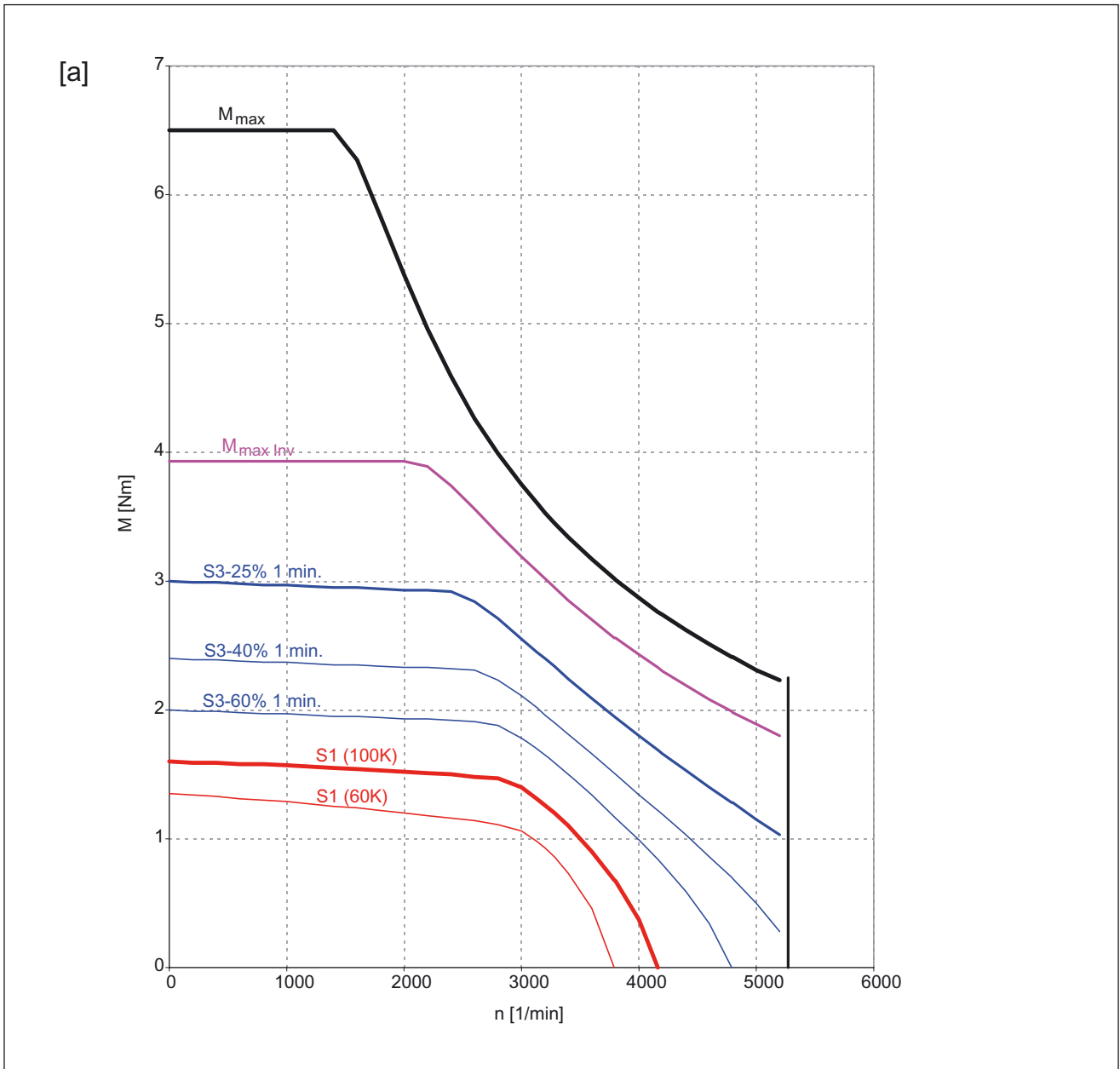

Figure 7-38 1FK7034-5AF21

[a] SINAMICS 1AC 230 V

Table 7-39 1FK7042

Technical data	Code	Unit	-5AF21	
Configuration data				
Rated speed	n_N	RPM	3000	
No. of poles	2p		8	
Rated torque (100 K)	M_N (100 K)	Nm	2.6	
Rated current (100 K)	I_N	A	3.5	
Static torque (60 K)	M_0 (60 K)	Nm	2.5	
Static torque (100 K)	M_0 (100 K)	Nm	3.0	
Stall current (60 K)	I_0 (60 K)	A	3.2	
Stall current (100 K)	I_0 (100 K)	A	3.9	
Moment of inertia (with brake)	J_{MotBr}	10^{-4} kgm ²	3.73	
Moment of inertia (without brake)	J_{Mot}	10^{-4} kgm ²	3.01	
Optimum operating point				
Optimum speed	n_{opt}	RPM	3000	
Optimum power	P_{opt}	kW	0.82	
Limiting data				
Max. permissible speed (mech.)	$n_{max\ mech}$	RPM	9000	
Max. permissible speed (converter)	$n_{max\ Inv}$	RPM	5910	
Max. torque	M_{max}	Nm	10.5	
Max. current	I_{max}	A	13.3	
Physical constants				
Torque constant	k_T	Nm/A	0.77	
Voltage constant	k_E	V/1000 RPM	49	
Winding resistance at 20°C	R_{Str}	Ohm	1.42	
Cyclic inductance	L_D	mH	8.0	
Electrical time constant	T_{el}	ms	5.6	
Mechanical time constant	T_{mech}	ms	2.16	
Thermal time constant	T_{th}	min	30	
Shaft torsional stiffness	C_t	Nm/rad	16000	
Weight with brake	m_{MotBr}	kg	5.4	
Weight without brake	m_{Mot}	kg	4.9	
Recommended power module 6SL3210-1SB14-0UA0				
Rated current converter	$I_N\ Inv$	A	3.9	
Max. current converter	$I_{max\ Inv}$	A	7.8	
Max. torque at $I_{max\ Inv}$	$M_{max\ Inv}$	Nm	6	

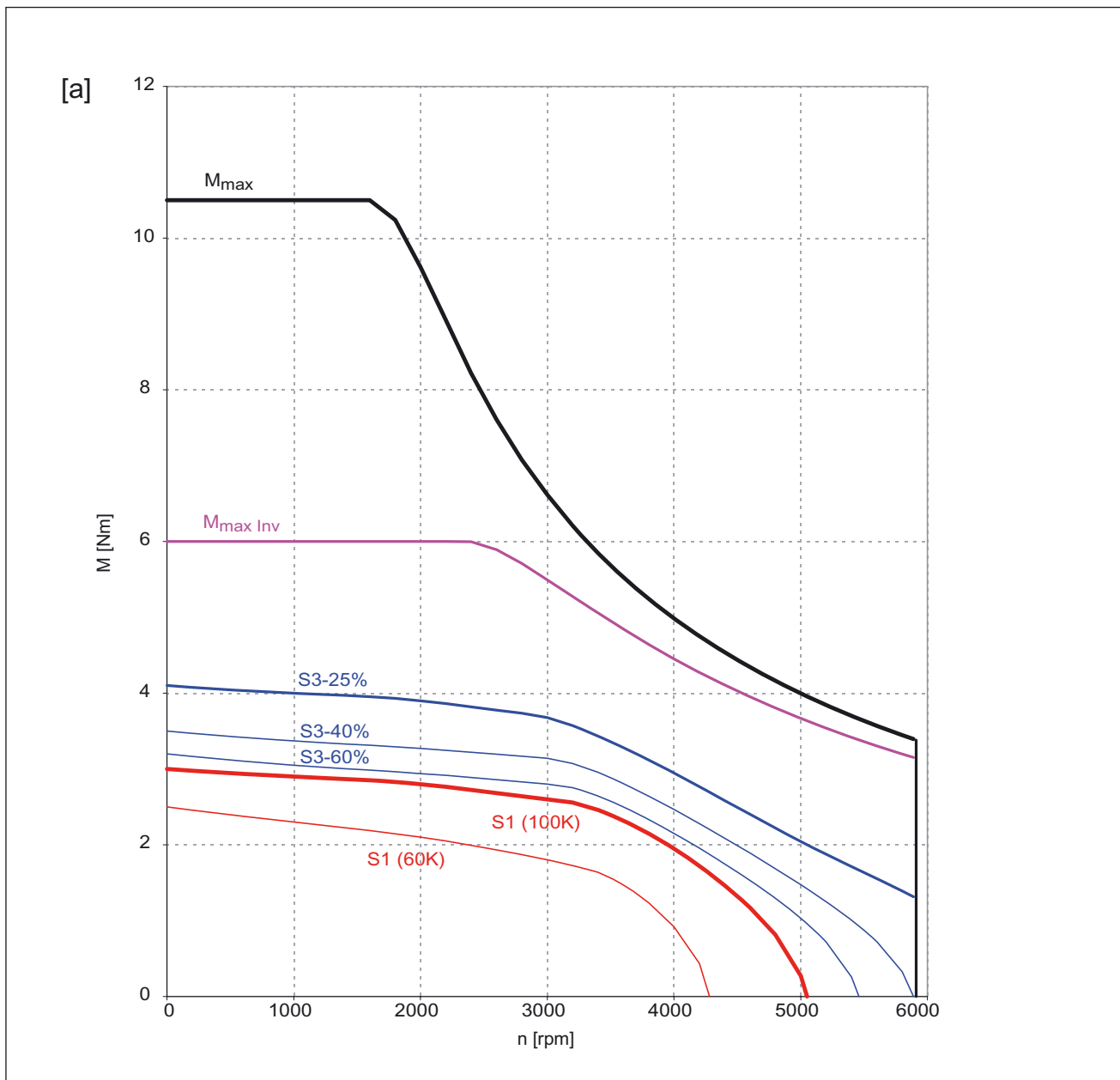

Figure 7-39 1FK7042-5AF21

[a] SINAMICS 1AC 230 V

Table 7-40 1FK7043

Technical data	Code	Unit	-7AF21	
Configuration data				
Rated speed	n_N	RPM	3000	
No. of poles	2p		6	
Rated torque (100 K)	M_N (100 K)	Nm	2.5	
Rated current (100 K)	I_N	A	3.8	
Static torque (60 K)	M_0 (60 K)	Nm	2.2	
Static torque (100 K)	M_0 (100 K)	Nm	2.7	
Stall current (60 K)	I_0 (60 K)	A	3.1	
Stall current (100 K)	I_0 (100 K)	A	3.9	
Moment of inertia (with brake)	J_{MotBr}	10^{-4} kgm ²	1.14	
Moment of inertia (without brake)	J_{Mot}	10^{-4} kgm ²	1.01	
Optimum operating point				
Optimum speed	n_{opt}	RPM	3000	
Optimum power	P_{opt}	kW	0.79	
Limiting data				
Max. permissible speed (mech.)	$n_{max\ mech}$	RPM	8000	
Max. permissible speed (converter)	$n_{max\ Inv}$	RPM	6580	
Max. torque	M_{max}	Nm	9.4	
Max. current	I_{max}	A	14.8	
Physical constants				
Torque constant	k_T	Nm/A	0.67	
Voltage constant	k_E	V/1000 RPM	44	
Winding resistance at 20°C	R_{Str}	Ohm	1.2	
Cyclic inductance	L_D	mH	15	
Electrical time constant	T_{el}	ms	12.5	
Mechanical time constant	T_{mech}	ms	0.81	
Thermal time constant	T_{th}	min	40	
Shaft torsional stiffness	C_t	Nm/rad	11000	
Weight with brake	m_{MotBr}	kg	7	
Weight without brake	m_{Mot}	kg	6.3	
Recommended power module 6SL3210-1SB14-0UA0				
Rated current converter	$I_N\ Inv$	A	3.9	
Max. current converter	$I_{max\ Inv}$	A	7.8	
Max. torque at $I_{max\ Inv}$	$M_{max\ Inv}$	Nm	5.2	

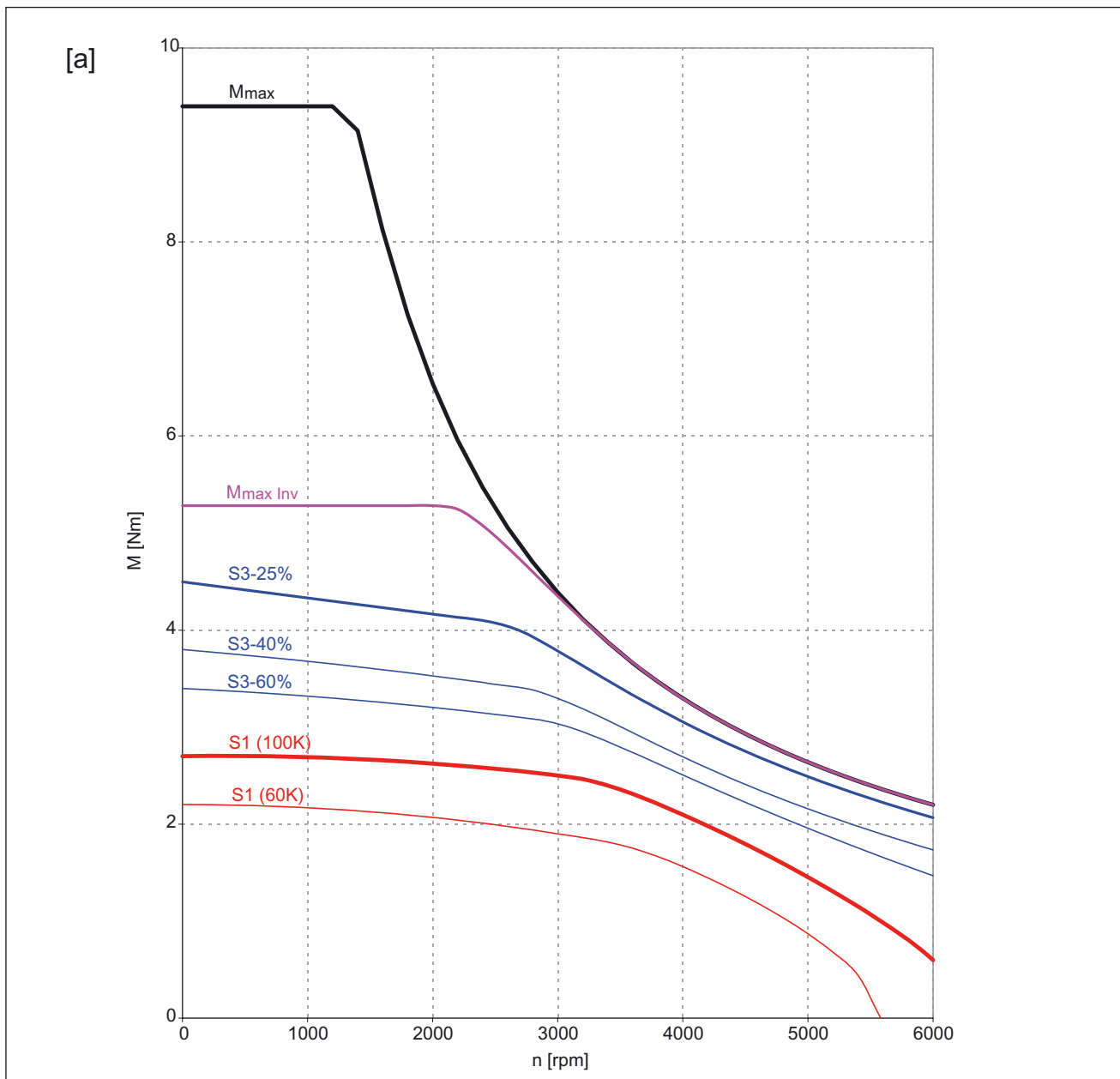

Figure 7-40 1FK7043-7AF21

[a] SINAMICS 1AC 230 V

7.4 Cantilever force diagrams

Cantilever force 1FK7011

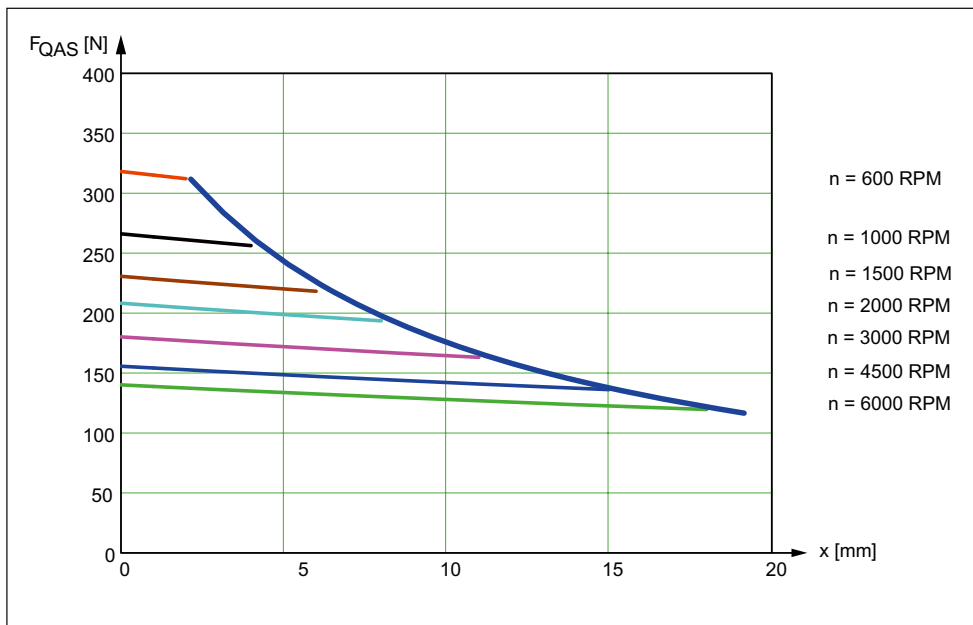

Figure 7-41 Cantilever force F_Q at a distance x from the shaft shoulder for a nominal bearing lifetime of 20,000 h.

Cantilever force 1FK7015

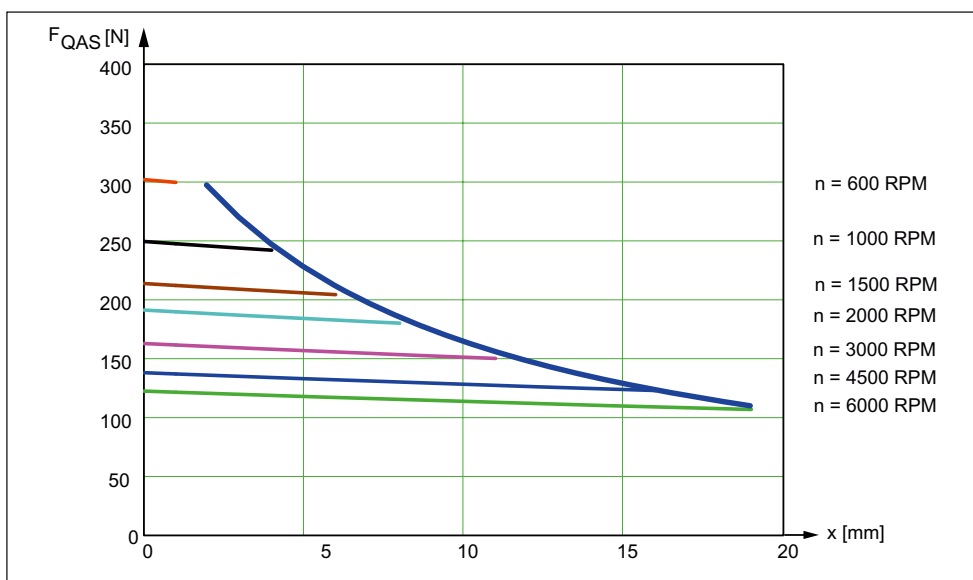

Figure 7-42 Cantilever force F_Q at a distance x from the shaft shoulder for a nominal bearing lifetime of 20,000 h.

Cantilever force 1FK702

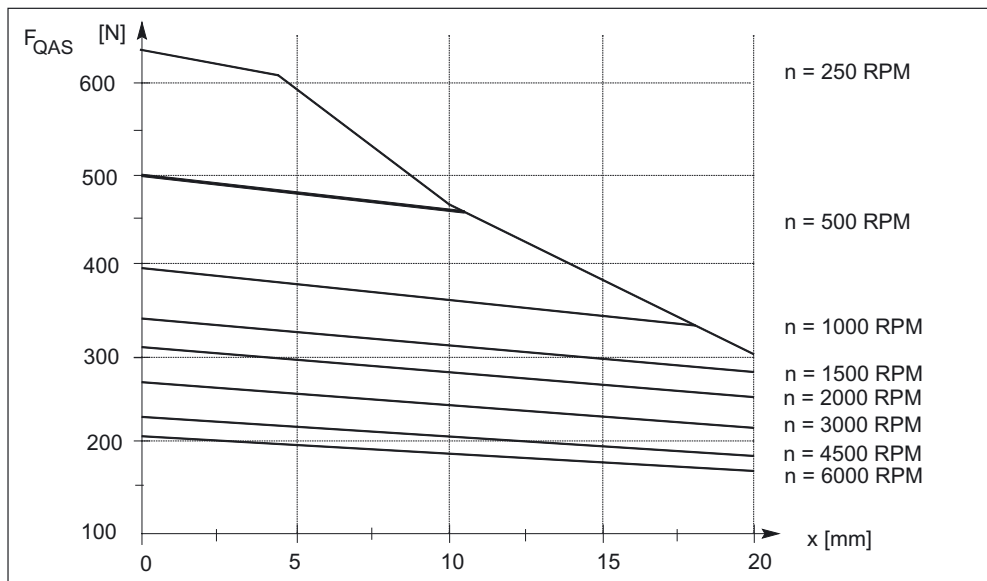

Figure 7-43 Cantilever force F_Q at a distance x from the shaft shoulder for a nominal bearing lifetime of 20,000 h.

Cantilever force 1FK703

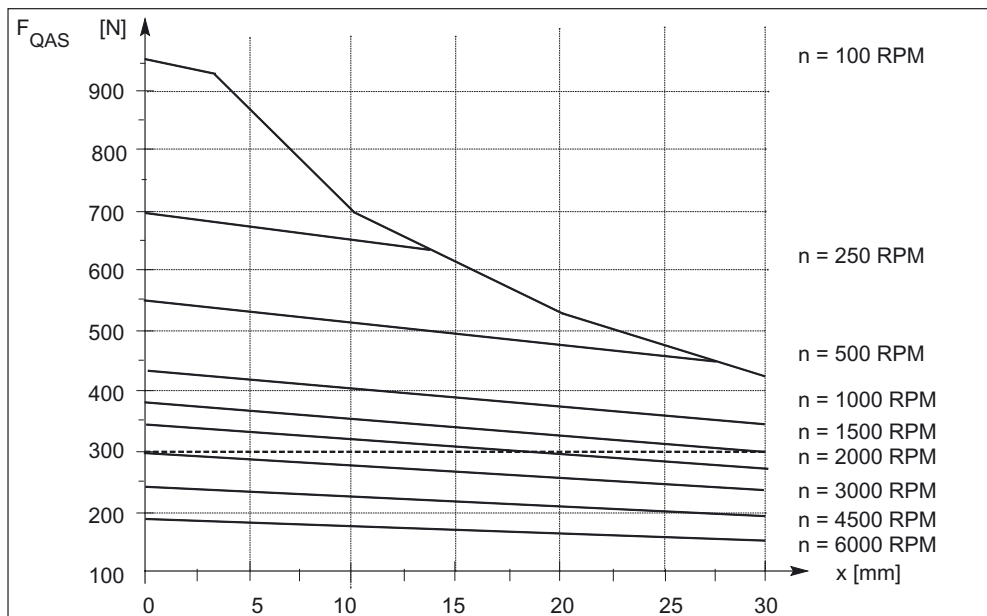

Figure 7-44 Cantilever force F_Q at a distance x from the shaft shoulder for a nominal bearing lifetime of 20,000 h.

Cantilever force 1FK704

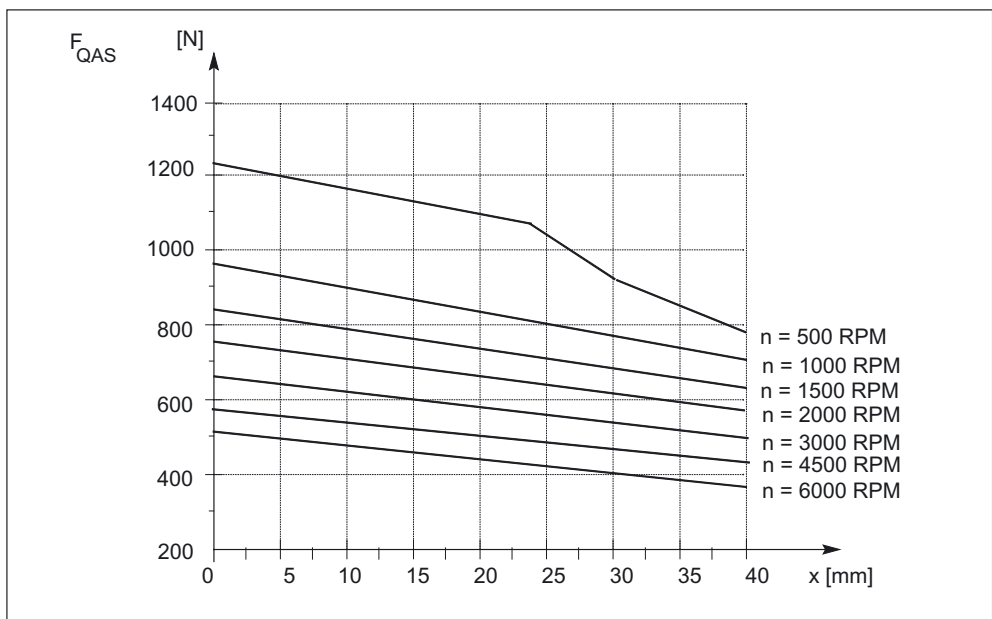

Figure 7-45 Cantilever force F_Q at a distance x from the shaft shoulder for a nominal bearing lifetime of 20,000 h.

Cantilever force 1FK706

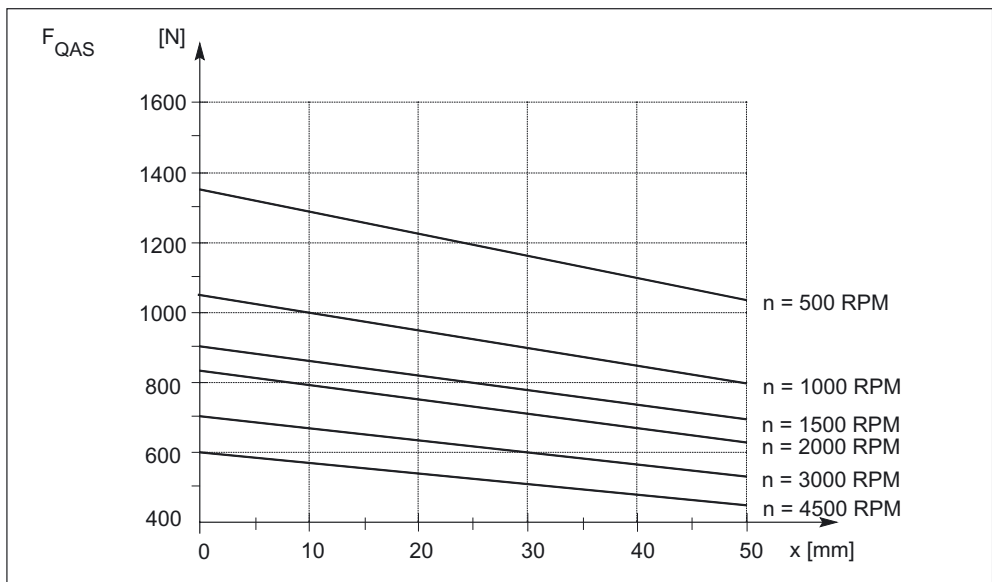

Figure 7-46 Cantilever force F_Q at a distance x from the shaft shoulder for a nominal bearing lifetime of 20,000 h.

Cantilever force 1FK708

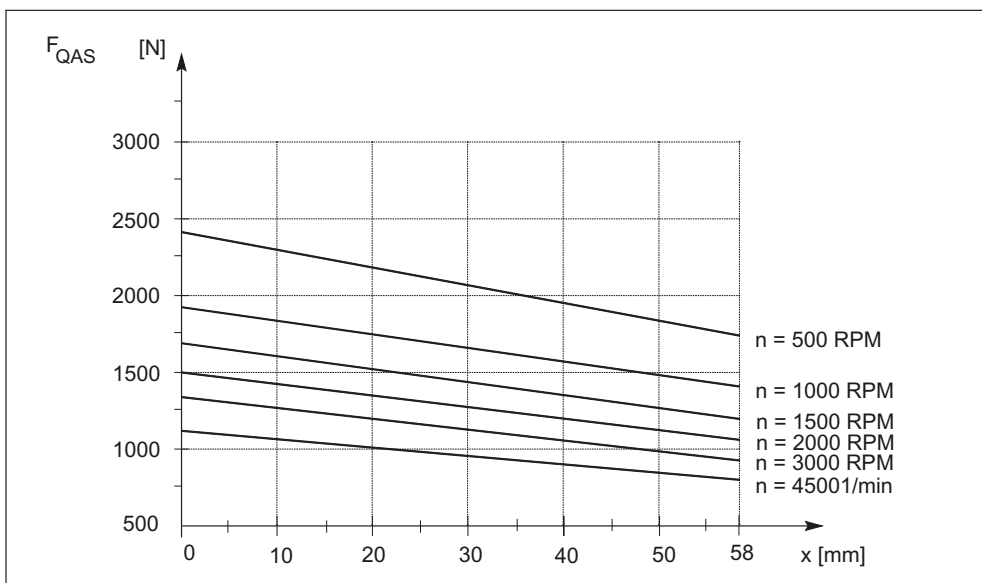

Figure 7-47 Cantilever force F_Q at a distance x from the shaft shoulder for a nominal bearing lifetime of 20,000 h.

Cantilever force 1FK710

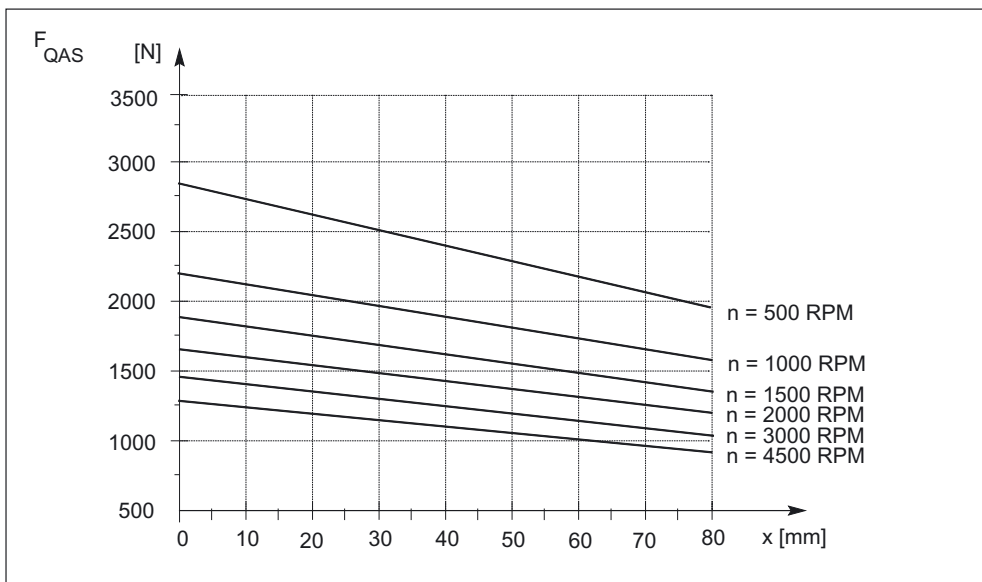

Figure 7-48 Cantilever force F_Q at a distance x from the shaft shoulder for a nominal bearing lifetime of 20,000 h.

Dimension drawings

CAD CREATOR

The CAD CREATOR provides a user-friendly interface which helps you to find product-specific data quickly and supports you in generating plant documentation containing project-specific information.

Benefits

- Multilingual operator interface in English, French, German, Italian and Spanish included
- Dimension sheets with measurements in mm or inches
- Dimension sheets and 2D/3D CAD data for
 - 1FT7/1FT6/1FK7 synchronous motors
 - 1PH7/1PH4/1PM4/1PM6 asynchronous motors
 - 1FT6/1FK7/1FK7-DYA geared motors
 - 1FW3 torque motors
 - 1FE1 built-in motors

The CAD CREATOR provides you with various options to begin with product configuration:

- Order number
- Order number search
- Geometric data

Once a product is successfully configured, the product-specific information, such as dimension drawing and 2D/3D CAD data are displayed and made available for storing in various formats, e.g.: *.pdf, *.dxf, *.stp oder *.igs.

The CAD CREATOR is available on CD-ROM and as an Internet application.

Additional information is available in the Internet under:

<http://www.siemens.com/cad-creator>

How up-to-date are the dimension drawings

Note

Siemens AG reserves the right to change the dimensions of the motors as part of mechanical design improvements without prior notice. This means that dimensions drawings can go out-of-date. Up-to-date dimension drawings can be requested at no charge from your local SIEMENS representative.

8.1 1FK7 Compact and High Dynamic motors

8.1.1 1FK7 Compact motors

For motor		Dimensions in mm (in)											Resolver						
Shaft height	Type	DIN IEC	a ₁ P	b ₁ N	c ₁ LA	e ₁ M	f AB	f ₁ T	g ₂ -	h H	i ₂ -	s ₂ S	without brake			with brake			
													k LB	o ₁ -	o ₂ -	k LB	o ₁ -	o ₂ -	
1FK7 Compact, type IM B5, natural cooling, with connector, with/without brake																			
20	1FK7011-5	-	30	7	46	40	2.5	65.5	20	18	4.5	140	89	118	140	89	118		
	1FK7015-5	-	30	7	46	40	2.5	65.5	20	18	4.5	165	114	143	165	114	143		
28	1FK7022-5	-	40	10	63	55	2.5	75	27.5	20	5.4	153	95	128	175	95	150		
	1FK7032-5	92	60	8	75	72	3	81	36	30	6.5	150	90	125	175	90	149		
36	1FK7034-5	92	60	8	75	72	3	81	36	30	6.5	175	115	150	200	115	174		
	1FK7040-5	120	80	10	100	96	3	90	48	40	7	134	73	106	163	73	135		
48	1FK7042-5	120	80	10	100	96	3	90	48	40	7	162	101	134	191	101	163		
	1FK7060-5	155	110	10	130	126	3.5	105	63	50	9	157	94	126	200	94	169		
63	1FK7063-5	155	110	10	130	126	3.5	105	63	50	9	202	139	171	245	139	214		
	1FK7063-5	155	110	10	130	126	3.5	105	63	50	9	202	139	171	245	139	214		
		Basic absolute encoder (EnDat) (shaft height 48 and larger), Incremental encoder sin/cos1 V _{pp}							Absolute encoder (EnDat)										
Shaft height	Type	without brake			with brake			without brake			with brake			d D	d ₆ -	l E	t GA	u F	
		k LB	o ₁ -	o ₂ -	k LB	o ₁ -	o ₂ -	k LB	o ₁ -	o ₂ -	k LB	o ₁ -	o ₂ -						
20	1FK7011-5	155	89	118	155	89	118	155	98	118	155	89	118	8	M3	18	8.8	2	
	1FK7015-5	180	114	143	180	114	143	180	114	143	180	114	143	8	M3	18	8.8	2	
28	1FK7022-5	178	95	128	200	95	150	178	95	128	200	95	150	9	M3	20	10.2	3	
	1FK7032-5	175	90	125	200	90	149	175	90	125	200	90	149	14	M5	30	16	5	
36	1FK7034-5	200	115	150	225	115	174	200	115	150	225	115	174	14	M5	30	16	5	
	1FK7040-5	155	73	106	184	73	135	163	73	106	192	73	135	19	M6	40	21.5	6	
48	1FK7042-5	182	101	134	211	101	163	191	101	134	220	101	163	19	M6	40	21.5	6	
	1FK7060-5	180	94	126	223	94	169	188	94	126	231	94	169	24	M8	50	27	8	
63	1FK7063-5	225	139	171	268	139	214	233	139	171	276	139	214	24	M8	50	27	8	

1FK701.-5
1FK702.-5
1FK703.-5
1FK704.-5
1FK706.-5

Shaft design
with fitted key

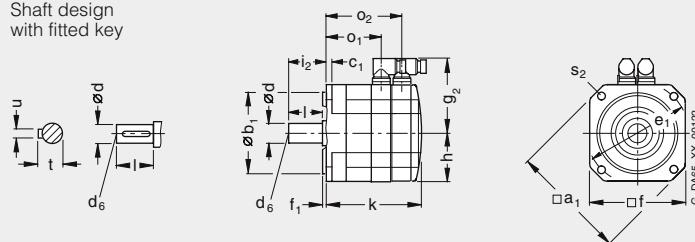

8.1 1FK7 Compact and High Dynamic motors

For motor		Dimensions in mm (in)											Resolver					
Shaft height	Type	DIN IEC	a ₁ P	b ₁ N	c ₁ LA	e ₁ M	f AB	f ₁ T	g ₂ -	h H	i ₂ -	s ₂ S	without brake			with brake		
		k LB	o ₁ -	o ₂ -	k LB	o ₁ -	o ₂ -	k LB	o ₁ -	o ₂ -	k LB	o ₁ -	o ₂ -					
1FK7 Compact, type IM B5, natural cooling, with connector, with/without brake																		
80	1FK7080-5	186 (7.32)	91 (3.58)	124 (4.88)	206 (8.11)	91 (3.58)	151 (5.94)	187 (7.36)	91 (3.58)	124 (4.88)	215 (8.46)	91 (3.58)	151 (5.94)	32 (1.26)	M12	58 (2.28)	35 (1.38)	10 (0.39)
	1FK7083-5	186 (7.32)	129 (5.08)	162 (6.38)	268 (10.55)	153 (6.02)	213 (8.39)	225 (8.86)	129 (5.08)	162 (6.38)	276 (10.87)	129 (5.08)	207 (8.15)	32 (1.26)	M12	58 (2.28)	35 (1.38)	10 (0.39)
100	1FK7100-5	240 (9.45)	113 (4.45)	153 (6.02)	227 (8.94)	113 (4.45)	172 (6.77)	216 (8.50)	113 (4.45)	153 (6.02)	235 (9.25)	113 (4.45)	172 (6.77)	38 (1.50)	M12	80 (3.15)	41 (1.61)	10 (0.39)
	1FK7101-5	240 (9.45)	139 (5.47)	179 (7.05)	263 (10.35)	139 (5.47)	208 (8.19)	242 (9.53)	139 (5.47)	179 (7.05)	271 (10.67)	139 (5.47)	208 (8.19)	38 (1.50)	M12	80 (3.15)	41 (1.61)	10 (0.39)
	1FK7103-5	240 (9.45)	165 (6.50)	205 (8.07)	289 (11.38)	165 (6.5)	234 (9.21)	268 (10.55)	165 (6.50)	205 (8.07)	297 (11.69)	165 (6.50)	234 (9.21)	38 (1.50)	M12	80 (3.15)	41 (1.61)	10 (0.39)
	1FK7105-5	240 (9.45)	217 (8.54)	257 (10.12)	341 (13.43)	217 (8.54)	286 (11.26)	320 (12.60)	217 (8.54)	257 (10.12)	349 (13.74)	217 (8.54)	286 (11.26)	38 (1.50)	M12	80 (3.15)	41 (1.61)	10 (0.39)

Shaft height	Type	Basic absolute encoder (EnDat) (shaft height 48 and larger), Incremental encoder sin/cos 1 V _{pp}						Absolute encoder (EnDat)										
		without brake			with brake			without brake			with brake							
k LB	o ₁ -	o ₂ -	k LB	o ₁ -	o ₂ -	k LB	o ₁ -	o ₂ -	k LB	o ₁ -	o ₂ -	d D	d ₆ -	l E	t GA	u F		
80	1FK7080-5	179 (7.05)	91 (3.58)	124 (4.88)	206 (8.11)	91 (3.58)	151 (5.94)	187 (7.36)	91 (3.58)	124 (4.88)	215 (8.46)	91 (3.58)	151 (5.94)	32 (1.26)	M12	58 (2.28)	35 (1.38)	10 (0.39)
	1FK7083-5	217 (8.54)	129 (5.08)	162 (6.38)	268 (10.55)	153 (6.02)	213 (8.39)	225 (8.86)	129 (5.08)	162 (6.38)	276 (10.87)	129 (5.08)	207 (8.15)	32 (1.26)	M12	58 (2.28)	35 (1.38)	10 (0.39)
100	1FK7100-5	208 (8.19)	113 (4.45)	153 (6.02)	227 (8.94)	113 (4.45)	172 (6.77)	216 (8.50)	113 (4.45)	153 (6.02)	235 (9.25)	113 (4.45)	172 (6.77)	38 (1.50)	M12	80 (3.15)	41 (1.61)	10 (0.39)
	1FK7101-5	234 (9.21)	139 (5.47)	179 (7.05)	263 (10.35)	139 (5.47)	208 (8.19)	242 (9.53)	139 (5.47)	179 (7.05)	271 (10.67)	139 (5.47)	208 (8.19)	38 (1.50)	M12	80 (3.15)	41 (1.61)	10 (0.39)
	1FK7103-5	260 (10.24)	165 (6.50)	205 (8.07)	289 (11.38)	165 (6.5)	234 (9.21)	268 (10.55)	165 (6.50)	205 (8.07)	297 (11.69)	165 (6.50)	234 (9.21)	38 (1.50)	M12	80 (3.15)	41 (1.61)	10 (0.39)
	1FK7105-5	312 (12.28)	217 (8.54)	257 (10.12)	341 (13.43)	217 (8.54)	286 (11.26)	320 (12.60)	217 (8.54)	257 (10.12)	349 (13.74)	217 (8.54)	286 (11.26)	38 (1.50)	M12	80 (3.15)	41 (1.61)	10 (0.39)

1FK708...-5

Shaft design with fitted key

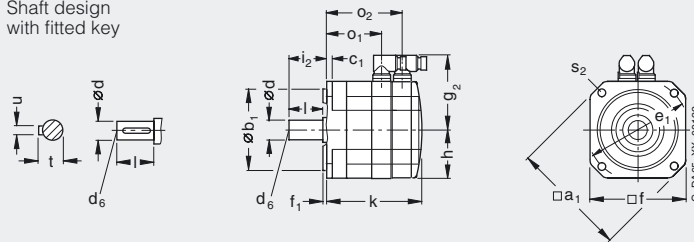

1FK7100-5
1FK7101-5
1FK7103-5
1FK7105-5

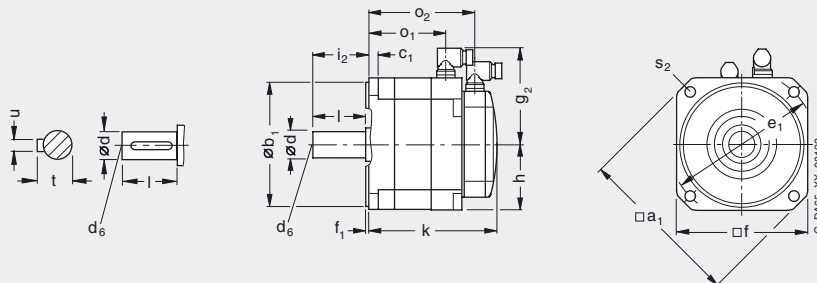

8.1.2 1FK7 High Dynamic motors

For motor		Dimensions in mm (in)											Resolver		
Shaft height	Type	DIN IEC	a ₁	b ₁	c ₁	e ₁	f	f ₁	g ₂	h	i ₂	s ₂	without/with brake		
			P	N	LA	M	AB	T	-	H	-	S	k	o ₁	o ₂
1FK7 High Dynamic, type IM B5, natural cooling, with connector, with/without brake															
36	1FK7033-7		92 (3.62)	60 (2.36)	8 (0.31)	75 (2.95)	72 (2.83)	3 (0.12)	78 (3.07)	36 (1.42)	30 (1.18)	6.5 (0.26)	170/195 (6.69/7.68)	108/108 (4.25/4.25)	145/170 (5.71/6.69)
48	1FK7043-7		120 (4.72)	80 (3.15)	10 (0.39)	100 (3.94)	96 (3.78)	3 (0.12)	90 (3.54)	48 (1.89)	40 (1.57)	7 (0.28)	191/220 (7.52/8.66)	130/130 (5.12/5.12)	163/192 (6.42/7.56)
	1FK7044-7											7 (0.28)	216/245 (8.51/9.65)	155/155 (6.10/6.10)	188/217 (7.40/8.54)
63	1FK7061-7		155 (6.10)	110 (4.33)	10 (0.39)	130 (5.12)	126 (4.96)	3.5 (0.14)	105 (4.13)	63 (2.48)	50 (1.97)	9 (0.35)	185/228 (7.28/8.98)	121/121 (4.76/4.76)	153/196 (6.02/7.72)
	1FK7064-7												249/292 (9.80/11.5)	185/185 (7.28/7.28)	217/260 (8.54/10.24)
80	1FK7085-7		186 (7.32)	130 (5.12)	13 (0.51)	165 (6.50)	155 (6.10)	3.5 (0.14)	141.5 (5.57)	77.5 (3.05)	60 (2.36)	11 (0.43)	261/304 (10.28/11.97)	190/191 (7.48/7.52)	229/272 (9.02/10.71)
	1FK7086-7								140.5 (5.53)				261/303 (10.28/11.93)	192/192 (7.56/7.56)	229/272 (9.02/10.71)
Shaft height	Type	DIN IEC	Basic absolute encoder (EnDat) (shaft height 48 and larger), Incremental encoder sin/cos1 V _{pp} without/with brake			Absolute encoder (EnDat) without/with brake			DE shaft extension						
			k	o ₁	o ₂	k	o ₁	o ₂	d	d ₆	l	t	u		
36	1FK7033-7		194/219 (7.64/8.62)	109/109 (4.29/4.29)	144/168 (5.67/6.61)	194/219 (7.64/8.62)	109/109 (4.29/4.29)	144/168 (5.67/6.61)	14	M5	30	16	5		
48	1FK7043-7		212/241 (8.35/9.49)	130/130 (5.12/5.12)	163/192 (6.42/7.56)	220/249 (8.66/9.80)	130/130 (5.12/5.12)	163/192 (6.42/7.56)	19	M6	40	21.5	6		
	1FK7044-7		237/266 (9.33/10.47)	155/155 (6.10/6.10)	188/217 (7.40/8.54)	245/274 (9.65/10.79)	155/155 (6.10/6.10)	188/217 (7.40/8.54)							
63	1FK7061-7		208/251 (8.19/9.88)	121/121 (4.76/4.76)	154/197 (6.06/7.76)	217/260 (8.54/10.24)	121/121 (4.76/4.76)	154/197 (6.06/7.76)	24	M6	50	27	8		
	1FK7064-7		272/315 (10.71/12.40)	185/185 (7.28/7.28)	218/261 (8.58/10.28)	281/324 (11.06/12.76)	185/185 (7.28/7.28)	218/261 (8.58/10.28)							
80	1FK7085-7		283/326 (11.14/12.83)	192/192 (7.56/7.56)	229/272 (9.02/10.71)	292/334 (11.50/13.15)	192/192 (7.56/7.56)	229/272 (9.02/10.71)	32	M12	58	35	10		
	1FK7086-7														

Shaft design with fitted key

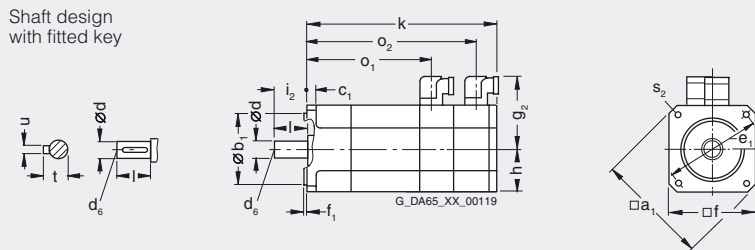

8.2 1FK7-DYA motors with planetary gearbox

1FK7-DYA motors without/with DRIVE-CLiQ (with planetary gearbox, single-stage)

For motor		Dimensions in mm (in)																
Shaft height	Type	Resolver				Basic absolute encoder (EnDat) ¹⁾				Incremental encoder sin/cos 1 V _{pp}				Absolute encoder (EnDat)				
		without brake		with brake		without brake		with brake		without brake		with brake		without brake		with brake		
		K	K1	K	K1	K	K1	K	K1	K	K1	K	K1	K	K1	K	K1	
1FK7-DYA (with planetary gearbox, single-stage), type IM B5, natural cooling, with connector, with/without brake																		
36	1FK7032-5	197 (7.76)	177 (6.97)	222 (8.74)	202 (7.95)	222 (8.74)	202 (7.95)	247 (9.72)	227 (8.94)	222 (8.74)	202 (7.95)	247 (9.72)	227 (8.94)	222 (8.74)	202 (7.95)	247 (9.72)	227 (8.94)	
	1FK7034-5	222 (8.74)	202 (7.95)	247 (9.72)	227 (8.94)	247 (9.72)	227 (8.94)	272 (10.71)	252 (9.92)	247 (9.72)	227 (8.94)	272 (10.71)	252 (9.92)	247 (9.72)	227 (8.94)	272 (10.71)	252 (9.92)	
48	1FK7040-5	194 (7.64)	174 (6.85)	223 (8.78)	203 (7.99)	214 (8.43)	194 (7.64)	243 (9.57)	223 (8.78)	223 (8.78)	203 (7.99)	252 (9.92)	232 (9.13)	223 (8.78)	203 (7.99)	252 (9.92)	232 (9.13)	
	1FK7042-5	221 (8.70)	201 (7.91)	250 (9.84)	230 (9.06)	242 (9.53)	222 (8.74)	271 (10.67)	251 (9.88)	250 (9.84)	230 (9.06)	279 (10.98)	259 (10.20)	250 (9.84)	230 (9.06)	279 (10.98)	259 (10.20)	
63	1FK7060-5	233 (9.17)	208 (8.19)	261 (10.28)	236 (9.29)	256 (10.08)	231 (9.09)	284 (11.18)	259 (10.20)	264 (10.39)	239 (9.41)	292 (11.50)	267 (10.51)	264 (10.39)	239 (9.41)	292 (11.50)	267 (10.51)	
	1FK7063-5	278 (10.94)	253 (9.96)	306 (12.05)	281 (11.06)	301 (11.85)	276 (10.87)	329 (12.95)	304 (11.97)	309 (12.17)	284 (11.18)	337 (13.27)	312 (12.28)	309 (12.17)	284 (11.18)	337 (13.27)	312 (12.28)	
80	1FK7080-5	250 (9.84)	220 (8.66)	278 (10.94)	248 (9.76)	273 (10.75)	243 (9.57)	300 (11.81)	270 (10.63)	281 (11.06)	251 (9.88)	309 (12.17)	279 (10.98)	281 (11.06)	251 (9.88)	309 (12.17)	279 (10.98)	
	1FK7083-5	288 (11.34)	258 (10.16)	339 (13.35)	309 (12.17)	311 (12.24)	281 (11.06)	362 (14.25)	332 (13.07)	339 (13.35)	319 (12.56)	370 (14.57)	340 (13.39)	339 (13.35)	319 (12.56)	370 (14.57)	340 (13.39)	
Planetary gearbox																		
Shaft height	Type	Type	D1	D2	D3	D4	D5	D7	D8	L1	L2	L3	L4	L5	L8	L9	L10	L12
36	1FK7032-5	DYA70-10	70 (2.76)	52 (2.05)	16 (0.63)	62 (2.44)	M5	82 (3.23)	5.5 (0.22)	56 (2.20)	28 (1.10)	5 (0.20)	8 (0.31)	10 (0.39)	18 (0.71)	5 (0.20)	20 (0.79)	76 (2.99)
	1FK7034-5	DYA70-5	70 (2.76)	52 (2.05)	16 (0.63)	62 (2.44)	M5	82 (3.23)	5.5 (0.22)	56 (2.20)	28 (1.10)	5 (0.20)	8 (0.31)	10 (0.39)	18 (0.71)	5 (0.20)	20 (0.79)	76 (2.99)
48	1FK7040-5	DYA90-10	90 (3.54)	68 (2.68)	22 (0.87)	80 (3.15)	M6	105 (4.13)	7 (0.28)	66 (2.60)	36 (1.42)	5 (0.20)	10 (0.39)	12 (0.47)	24.5 (0.96)	6 (0.24)	20 (0.79)	101 (3.98)
	1FK7042-5	DYA90-5	90 (3.54)	68 (2.68)	22 (0.87)	80 (3.15)	M6	105 (4.13)	7 (0.28)	66 (2.60)	36 (1.42)	5 (0.20)	10 (0.39)	12 (0.47)	24.5 (0.96)	6 (0.24)	20 (0.79)	101 (3.98)
63	1FK7060-5	DYA120-10	120 (4.72)	90 (3.54)	32 (1.26)	108 (4.25)	M8	140 (5.51)	9 (0.35)	95 (3.74)	58 (2.28)	6 (0.24)	12 (0.47)	16 (0.63)	35 (1.38)	10 (0.39)	25 (0.98)	128 (5.04)
	1FK7063-5	DYA120-5	120 (4.72)	90 (3.54)	32 (1.26)	108 (4.25)	M8	140 (5.51)	9 (0.35)	95 (3.74)	58 (2.28)	6 (0.24)	12 (0.47)	16 (0.63)	35 (1.38)	10 (0.39)	25 (0.98)	128 (5.04)
80	1FK7080-5	DYA155-10	155 (6.10)	120 (4.72)	40 (1.57)	140 (5.51)	M10	170 (6.69)	11 (0.43)	127 (5.00)	82 (3.23)	8 (0.31)	15 (0.59)	20 (0.79)	43 (1.69)	12 (0.47)	30 (1.18)	161 (6.34)
	1FK7083-5	DYA155-5	155 (6.10)	120 (4.72)	40 (1.57)	140 (5.51)	M10	170 (6.69)	11 (0.43)	127 (5.00)	82 (3.23)	8 (0.31)	15 (0.59)	20 (0.79)	43 (1.69)	12 (0.47)	30 (1.18)	161 (6.34)

1FK703.-5
1FK704.-5
1FK706.-5
1FK708.-5

¹⁾ 1FK7032 and 1FK7034 motors cannot be supplied with a basic absolute encoder.

8.3 1FK7 motors with planetary gearbox SP+

1FK7 Compact motors without/with DRIVE-CLiQ, with planetary gearbox SP+, single-stage

For motor		Dimensions in mm (in)											Resolver		Incremental encoder sin/cos 1 V _{pp} , Basic absolute encoder (EnDat) ¹⁾		Absolute encoder (EnDat)		
Shaft height	Type	F4	Planetary gearbox Type	D1	D2	D3	D4	L5	L6	L7	L8	K	without brake	with brake	without brake	with brake	without brake	with brake	
1FK7 Compact with SP+ planetary gearbox, single-stage, type IM B5, natural cooling, with connector, without/with brake																			
28	1FK7022-5	62 (2.44)	SP060S-MF1	60 (2.36)	16 (0.63)	6 (0.24)	68 (2.68)	137 (5.40)	28 (1.10)	20 (0.79)	6 (0.24)	242 (9.53)	264 (10.40)	267 (10.52)	289 (11.39)	267 (10.52)	289 (11.39)		
36	1FK7032-5	62 (2.44)	SP060S-MF1	60 (2.36)	16 (0.63)	6 (0.24)	68 (2.68)	142 (5.59)	28 (1.10)	20 (0.79)	6 (0.24)	244 (9.61)	269 (10.60)	269 (10.60)	294 (11.58)	269 (10.60)	294 (11.58)		
48	1FK7040-5	76 (2.99)	SP075S-MF1	70 (2.76)	22 (0.87)	7 (0.28)	85 (3.35)	168 (6.62)	36 (1.42)	20 (0.79)	7 (0.28)	246 (9.69)	275 (10.84)	267 (10.52)	296 (11.66)	275 (10.84)	304 (11.98)		
	1FK7042-5	76 (2.99)	SP075S-MF1	70 (2.76)	22 (0.87)	7 (0.28)	85 (3.35)	168 (6.62)	36 (1.42)	20 (0.79)	7 (0.28)	274 (10.80)	303 (11.94)	294 (11.58)	323 (12.73)	303 (11.94)	332 (13.08)		
63	1FK7060-5	101 (3.98)	SP100S-MF1	90 (3.55)	32 (1.26)	9 (0.35)	120 (4.73)	217 (8.55)	58 (2.29)	30 (1.18)	10 (0.39)	286 (11.27)	329 (12.96)	309 (12.17)	352 (13.87)	317 (12.49)	360 (14.18)		
	1FK7063-5	101 (3.98)	SP100S-MF1	90 (3.55)	32 (1.26)	9 (0.35)	120 (4.73)	217 (8.55)	58 (2.29)	30 (1.18)	10 (0.39)	331 (13.04)	374 (14.74)	354 (13.95)	397 (15.64)	362 (14.26)	405 (15.96)		
80	1FK7080-5	141 (5.56)	SP140S-MF1	130 (5.12)	40 (1.58)	11 (0.43)	165 (6.50)	283 (11.15)	82 (3.23)	30 (1.18)	12 (0.47)	327 (12.88)	355 (13.99)	350 (13.79)	377 (14.85)	358 (14.11)	386 (15.21)		
	1FK7083-5	141 (5.56)	SP140S-MF1	130 (5.12)	40 (1.58)	11 (0.43)	165 (6.50)	283 (11.15)	82 (3.23)	30 (1.18)	12 (0.47)	365 (14.38)	416 (16.39)	388 (15.29)	439 (17.30)	396 (15.60)	447 (17.61)		
100	1FK7100-5	182 (7.17)	SP180S-MF1	160 (6.30)	55 (2.17)	14 (0.55)	215 (8.47)	310 (12.21)	82 (3.23)	30 (1.18)	15 (0.59)	383 (15.09)	402 (15.84)	406 (16.00)	425 (16.75)	414 (16.31)	433 (17.06)		
	1FK7101-5	182 (7.17)	SP180S-MF1	160 (6.30)	55 (2.17)	14 (0.55)	215 (8.47)	310 (12.21)	82 (3.23)	30 (1.18)	15 (0.59)	409 (16.11)	438 (17.26)	432 (17.02)	461 (18.16)	440 (17.34)	469 (18.48)		
	1FK7103-5	182 (7.17)	SP180S-MF1	160 (6.30)	55 (2.17)	14 (0.55)	215 (8.47)	310 (12.21)	82 (3.23)	30 (1.18)	15 (0.59)	435 (17.14)	464 (18.28)	458 (18.05)	487 (19.19)	466 (18.36)	495 (19.50)		
	1FK7105-5	182 (7.17)	SP180S-MF1	160 (6.30)	55 (2.17)	14 (0.55)	215 (8.47)	310 (12.21)	82 (3.23)	30 (1.18)	15 (0.59)	487 (19.19)	516 (20.33)	510 (20.09)	539 (21.24)	518 (20.41)	547 (21.55)		
	1FK7105-5	212 (8.35)	SP210-MF1	180 (7.09)	75 (2.96)	17 (0.67)	250 (9.85)	350 (13.79)	105 (4.14)	38 (1.50)	17 (0.67)	496 (19.54)	525 (20.69)	519 (20.45)	548 (21.59)	527 (20.76)	556 (21.91)		

1FK702-5
1FK703-5
1FK704-5
1FK706-5
1FK708-5
1FK710-5

¹⁾ 1FK022 and 1FK7032 motors cannot be supplied with basic absolute encoders.

1FK7 High Dynamic motors without/with DRIVE-CLiQ with planetary gearbox SP+, single-stage

For motor		Dimensions in mm (in)										Resolver		Incremental encoder sin/cos 1 V _{pp} , Basic absolute encoder (EnDat) ¹⁾		Absolute encoder (EnDat)		
Shaft height	Type	F4	Planetary gearbox Type	D1	D2	D3	D4	L5	L6	L7	L8	without brake K	with brake K	without brake K	with brake K	without brake K	with brake K	
1FK7 High Dynamic with SP+ planetary gearbox, single-stage, type IM B5, natural cooling, with connector, without/with brake																		
36	1FK7033-7	62 (2.44)	SP060S-MF1	60 (2.36)	16 (0.63)	6 (0.24)	68 (2.68)	142 (5.59)	28 (1.10)	20 (0.79)	6 (0.24)	263 (10.36)	288 (11.35)	288 (11.35)	313 (12.33)	288 (11.35)	313 (12.33)	
48	1FK7043-7	76 (2.99)	SP075S-MF1	70 (2.76)	22 (0.87)	7 (0.28)	85 (3.35)	168 (6.62)	36 (1.42)	20 (0.79)	7 (0.28)	303 (11.94)	332 (13.08)	324 (12.77)	353 (13.91)	332 (13.08)	361 (14.22)	
	1FK7044-7	76 (2.99)	SP075S-MF1	70 (2.76)	22 (0.87)	7 (0.28)	85 (3.35)	168 (6.62)	36 (1.42)	20 (0.79)	7 (0.28)	328 (12.92)	357 (14.07)	349 (13.75)	378 (14.89)	357 (14.07)	386 (15.21)	
63	1FK7061-7	101 (3.98)	SP100S-MF1	90 (3.55)	32 (1.26)	9 (0.35)	120 (4.73)	217 (8.55)	58 (2.29)	30 (1.18)	10 (0.39)	314 (12.37)	357 (14.07)	337 (13.28)	380 (14.97)	346 (13.63)	389 (15.33)	
	1FK7064-7	101 (3.98)	SP100S-MF1	90 (3.55)	32 (1.26)	9 (0.35)	120 (4.73)	217 (8.55)	58 (2.29)	30 (1.18)	10 (0.39)	378 (14.89)	421 (16.59)	401 (15.80)	444 (17.49)	410 (16.15)	453 (17.85)	
80	1FK7085-7	141 (5.56)	SP140S-MF1	130 (5.12)	40 (1.58)	11 (0.43)	165 (6.50)	283 (11.15)	82 (3.23)	30 (1.18)	12 (0.47)	432 (17.02)	474 (18.68)	454 (17.89)	497 (19.58)	463 (18.24)	505 (19.90)	
	1FK7086-7	141 (5.56)	SP140S-MF1	130 (5.12)	40 (1.58)	11 (0.43)	165 (6.50)	283 (11.15)	82 (3.23)	30 (1.18)	12 (0.47)	432 (17.02)	474 (18.68)	454 (17.89)	497 (19.58)	463 (18.24)	505 (19.90)	

1FK703.-7
1FK704.-7
1FK706.-7
1FK708.-7

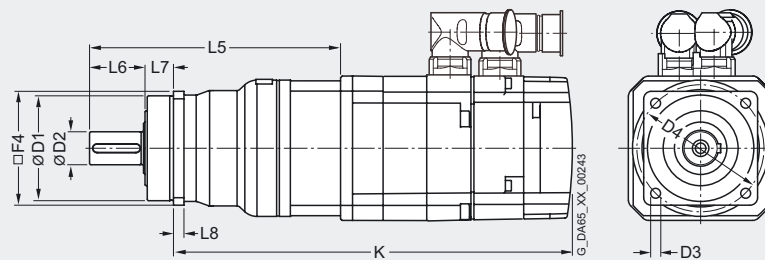

¹⁾ The 1FK7033 motor cannot be supplied with a basic absolute encoder.

1FK7 Compact motors without/with DRIVE-CLiQ, with planetary gearbox SP+, two-stage

For motor		Dimensions in mm (in)											Resolver		Incremental encoder sin/cos 1 V _{pp} , Basic absolute encoder (EnDat) ¹⁾		Absolute encoder (EnDat)	
Shaft height	Type	F4	Planetary gearbox Type	D1	D2	D3	D4	L5	L6	L7	L8	without brake	with brake	without brake	with brake	without brake	with brake	
												K	K	K	K	K	K	
1FK7 Compact with SP+ planetary gearbox, two-stage, type IM B5, natural cooling, with connector, without/with brake																		
28	1FK7022-5	62 (2.44)	SP060S-MF2	60 (2.36)	16 (0.63)	5.5 (0.22)	68 (2.68)	156 (6.15)	28 (1.10)	20 (0.79)	6 (0.24)	261 (10.28)	283 (11.15)	286 (11.27)	308 (12.14)	286 (11.27)	308 (12.14)	
	1FK7022-5	76 (2.99)	SP075S-MF2	70 (2.76)	22 (0.87)	6.6 (0.26)	85 (3.35)	175 (6.90)	36 (1.42)	20 (0.79)	7 (0.28)	272 (10.72)	294 (11.58)	297 (11.70)	319 (12.57)	297 (11.70)	319 (12.57)	
	1FK7022-5	101 (3.98)	SP100S-MF2	90 (3.55)	32 (1.26)	9 (0.35)	120 (4.73)	230 (9.06)	58 (2.29)	30 (1.18)	10 (0.39)	295 (11.62)	317 (12.49)	320 (12.61)	342 (13.47)	320 (12.61)	342 (13.47)	
36	1FK7032-5	62 (2.44)	SP060S-MF2	60 (2.36)	16 (0.63)	5.5 (0.22)	68 (2.68)	164 (6.46)	28 (1.10)	20 (0.79)	6 (0.24)	266 (10.48)	291 (11.47)	291 (11.47)	316 (12.45)	291 (11.47)	316 (12.45)	
	1FK7032-5	76 (2.99)	SP075S-MF2	70 (2.76)	22 (0.87)	6.6 (0.26)	85 (3.35)	179 (7.05)	36 (1.42)	20 (0.79)	7 (0.28)	273 (10.76)	298 (11.74)	298 (11.74)	323 (12.73)	298 (11.74)	323 (12.73)	
	1FK7032-5	101 (3.98)	SP100S-MF2	90 (3.55)	32 (1.26)	9 (0.35)	120 (4.73)	230 (9.06)	58 (2.29)	30 (1.18)	10 (0.39)	292 (11.50)	317 (12.49)	317 (12.49)	342 (13.47)	317 (12.49)	342 (13.47)	
48	1FK7040-5	76 (2.99)	SP075S-MF2	70 (2.76)	22 (0.87)	6.6 (0.26)	85 (3.35)	192 (7.56)	36 (1.42)	20 (0.79)	7 (0.28)	270 (10.64)	299 (11.78)	291 (11.47)	320 (12.61)	299 (11.78)	328 (12.92)	
	1FK7040-5	101 (3.98)	SP100S-MF2	90 (3.55)	32 (1.26)	9 (0.35)	120 (4.73)	234 (9.22)	58 (2.29)	10 (0.39)	10 (0.39)	280 (11.03)	309 (12.17)	301 (11.86)	330 (13.00)	309 (12.17)	338 (13.32)	
	1FK7040-5	141 (5.56)	SP140S-MF2	130 (5.12)	40 (1.58)	11 (0.43)	165 (6.50)	298 (11.74)	82 (3.23)	30 (1.18)	12 (0.47)	320 (12.61)	349 (13.75)	341 (13.44)	370 (14.58)	349 (13.75)	378 (14.89)	
	1FK7042-5	76 (2.99)	SP075S-MF2	70 (2.76)	22 (0.87)	6.6 (0.26)	85 (3.35)	192 (7.56)	36 (1.42)	20 (0.79)	7 (0.28)	298 (11.74)	327 (12.88)	298 (11.74)	347 (13.67)	327 (12.88)	356 (14.03)	
	1FK7042-5	101 (3.98)	SP100S-MF2	90 (3.55)	32 (1.26)	9 (0.35)	120 (4.73)	234 (9.22)	58 (2.29)	10 (0.39)	10 (0.39)	308 (12.14)	337 (13.28)	308 (12.14)	357 (14.07)	337 (13.28)	366 (14.42)	
	1FK7042-5	141 (5.56)	SP140S-MF2	130 (5.12)	40 (1.58)	11 (0.43)	165 (6.50)	298 (11.74)	82 (3.23)	30 (1.18)	12 (0.47)	348 (13.71)	377 (14.85)	368 (14.50)	397 (15.64)	377 (14.85)	406 (16.00)	
63	1FK7060-5	101 (3.98)	SP100S-MF2	90 (3.55)	32 (1.26)	9 (0.35)	120 (4.73)	252 (9.93)	58 (2.29)	30 (1.18)	10 (0.39)	321 (12.65)	364 (14.34)	344 (13.55)	387 (15.25)	352 (13.87)	395 (15.56)	
	1FK7060-5	141 (5.56)	SP140S-MF2	130 (5.12)	40 (1.58)	11 (0.43)	165 (6.50)	305 (12.02)	82 (3.23)	30 (1.18)	12 (0.47)	350 (13.79)	393 (15.48)	373 (14.70)	416 (16.39)	381 (15.01)	424 (16.71)	
	1FK7063-5	141 (5.56)	SP140S-MF2	130 (5.12)	40 (1.58)	11 (0.43)	165 (6.50)	305 (12.02)	82 (3.23)	30 (1.18)	12 (0.47)	395 (15.56)	438 (17.26)	418 (16.47)	461 (18.16)	426 (16.78)	469 (18.48)	
	1FK7063-5	182 (7.17)	SP180S-MF2	160 (6.30)	55 (2.17)	13.5 (0.53)	215 (8.47)	346 (13.63)	82 (3.23)	30 (1.18)	15 (0.59)	436 (17.18)	479 (18.87)	459 (18.08)	502 (19.78)	467 (18.40)	510 (20.09)	

1FK702.-5
1FK703.-5
1FK704.-5
1FK706.-5

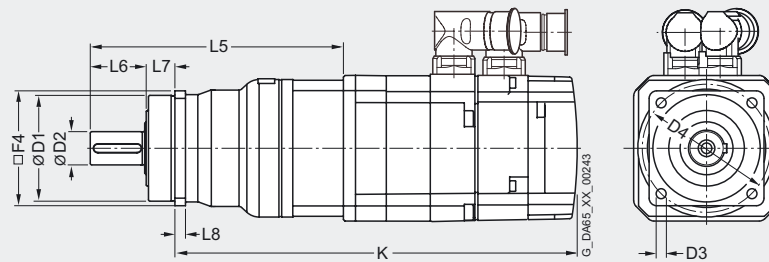

¹⁾ 1FK7022 and 1FK7032 motors cannot be supplied with a basic absolute encoder.

8.3 1FK7 motors with planetary gearbox SP+

For motor		Dimensions in mm (in)											Resolver		Incremental encoder sin/cos 1 V _{pp} , Basic absolute encoder (EnDat) ¹⁾		Absolute encoder (EnDat)	
Shaft height	Type	F4	Planetary gearbox Type	D1	D2	D3	D4	L5	L6	L7	L8	without brake	with brake	without brake	with brake	without brake	with brake	
				K	K	K	K	K	K									
1FK7 Compact with SP+ planetary gearbox, two-stage, type IM B5, natural cooling, with connector, without/with brake																		
80	1FK7080-5	141 (5.56)	SP140S-MF2	130 (5.12)	40 (1.58)	11 (0.43)	165 (6.50)	332 (13.08)	82 (3.23)	30 (1.18)	12 (0.47)	376 (14.81)	404 (15.92)	399 (15.72)	426 (16.78)	407 (16.04)	435 (17.14)	
	1FK7080-5	182 (7.17)	SP180S-MF2	160 (6.30)	55 (2.17)	13.5 (0.53)	215 (8.47)	355 (13.99)	82 (3.23)	30 (1.18)	15 (0.59)	399 (15.72)	427 (16.82)	422 (16.63)	449 (17.69)	430 (16.94)	458 (18.05)	
	1FK7080-5	212 (8.35)	SP210-MF2	180 (7.09)	75 (2.96)	17 (0.67)	250 (9.85)	397 (15.64)	105 (4.14)	38 (1.50)	17 (0.67)	410 (16.15)	438 (17.26)	433 (17.06)	460 (18.12)	441 (17.38)	469 (18.48)	
	1FK7083-5	141 (5.56)	SP140S-MF2	130 (5.12)	40 (1.58)	11 (0.43)	165 (6.50)	332 (13.08)	82 (3.23)	30 (1.18)	12 (0.47)	414 (16.31)	465 (18.32)	437 (17.22)	488 (19.23)	445 (17.53)	496 (19.54)	
	1FK7083-5	182 (7.17)	SP180S-MF2	160 (6.30)	55 (2.17)	13.5 (0.53)	215 (8.47)	355 (13.99)	82 (3.23)	30 (1.18)	15 (0.59)	437 (17.22)	488 (19.23)	460 (18.12)	511 (20.13)	468 (18.44)	519 (20.45)	
	1FK7083-5	212 (8.35)	SP210-MF2	180 (7.09)	75 (2.96)	17 (0.67)	250 (9.85)	397 (15.64)	105 (4.14)	38 (1.50)	17 (0.67)	448 (17.65)	499 (19.66)	471 (18.56)	522 (20.57)	479 (18.87)	530 (20.88)	
100	1FK7100-5	182 (7.17)	SP180S-MF2	160 (6.30)	55 (2.17)	13.5 (0.53)	215 (8.47)	310 (12.21)	82 (3.23)	30 (1.18)	15 (0.59)	383 (15.09)	402 (15.84)	406 (16.00)	425 (16.75)	414 (16.31)	433 (17.06)	
	1FK7100-5	212 (8.35)	SP210-MF2	180 (7.09)	75 (2.96)	17 (0.67)	250 (9.85)	397 (15.64)	105 (4.14)	38 (1.50)	17 (0.67)	439 (17.30)	458 (18.05)	462 (18.20)	481 (18.95)	470 (18.52)	489 (19.27)	
	1FK7101-5	182 (7.17)	SP180S-MF2	160 (6.30)	55 (2.17)	13.5 (0.53)	215 (8.47)	310 (12.21)	82 (3.23)	30 (1.18)	15 (0.59)	409 (16.11)	438 (17.26)	432 (17.02)	461 (18.16)	440 (17.34)	469 (18.48)	
	1FK7101-5	212 (8.35)	SP210-MF2	180 (7.09)	75 (2.96)	17 (0.67)	250 (9.85)	397 (15.64)	105 (4.14)	38 (1.50)	17 (0.67)	465 (18.32)	494 (19.46)	488 (19.23)	517 (20.37)	496 (19.54)	525 (20.69)	
	1FK7101-5	242 (9.53)	SP240-MF2	200 (7.88)	85 (3.35)	17 (0.67)	290 (11.43)	454 (17.89)	130 (5.12)	40 (1.58)	20 (0.79)	495 (19.50)	524 (20.65)	518 (20.41)	547 (21.55)	526 (20.72)	555 (21.87)	
	1FK7103-5	182 (7.17)	SP180S-MF2	160 (6.30)	55 (2.17)	13.5 (0.53)	215 (8.47)	310 (12.21)	82 (3.23)	30 (1.18)	15 (0.59)	435 (17.14)	464 (18.28)	458 (18.05)	487 (19.19)	466 (18.36)	495 (19.50)	
	1FK7103-5	212 (8.35)	SP210-MF2	180 (7.09)	75 (2.96)	17 (0.67)	250 (9.85)	397 (15.64)	105 (4.14)	38 (1.50)	17 (0.67)	491 (19.35)	520 (20.49)	514 (20.25)	543 (21.39)	522 (20.57)	551 (21.71)	
	1FK7103-5	242 (9.53)	SP240-MF2	200 (7.88)	85 (3.35)	17 (0.67)	290 (11.43)	454 (17.89)	130 (5.12)	40 (1.58)	20 (0.79)	521 (20.53)	550 (21.67)	544 (21.43)	573 (22.58)	552 (21.75)	581 (22.89)	
	1FK7105-5	212 (8.35)	SP210-MF2	180 (7.09)	75 (2.96)	17 (0.67)	250 (9.85)	397 (15.64)	105 (4.14)	38 (1.50)	17 (0.67)	543 (21.39)	572 (22.54)	566 (22.30)	595 (23.44)	574 (22.62)	603 (23.76)	
	1FK7105-5	242 (9.53)	SP240-MF2	200 (7.88)	85 (3.35)	17 (0.67)	290 (11.43)	454 (17.89)	130 (5.12)	40 (1.58)	20 (0.79)	573 (22.58)	602 (23.72)	596 (23.48)	625 (24.63)	604 (23.80)	633 (24.94)	

1FK708-5
1FK710-5

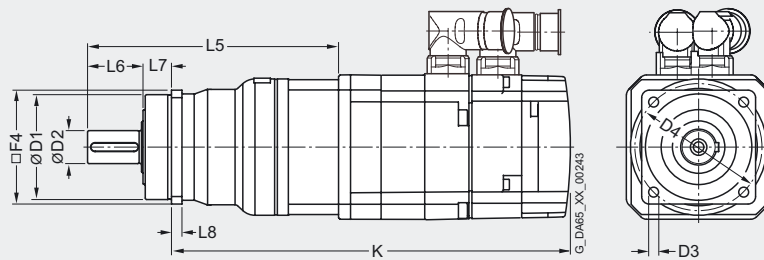

1FK7 High Dynamic motors without/with DRIVE-CLiQ with planetary gearbox SP+, two-stage

For motor				Dimensions in mm (in)								Resolver		Incremental encoder sin/cos 1 V _{pp} , Basic absolute encoder (EnDat) ¹⁾		Absolute encoder (EnDat)	
Shaft height	Type	F4	Planetary gearbox Type	D1	D2	D3	D4	L5	L6	L7	L8	without brake K	with brake K	without brake K	with brake K	without brake K	with brake K
1FK7 High Dynamic with SP+ planetary gearbox, two-stage, type IM B5, natural cooling, with connector, without/with brake																	
36	1FK7033-7	62 (2.44)	SP060S-MF2	60 (2.36)	16 (0.63)	5.5 (0.22)	68 (2.68)	164 (6.46)	28 (1.10)	20 (0.79)	6 (0.24)	285 (11.23)	310 (12.21)	310 (12.21)	335 (13.20)	310 (12.21)	335 (13.20)
	1FK7033-7	76 (2.99)	SP075S-MF2	70 (2.76)	22 (0.87)	6.6 (0.26)	85 (3.35)	179 (7.05)	36 (1.42)	20 (0.79)	7 (0.28)	292 (11.50)	317 (12.49)	317 (12.49)	342 (13.47)	317 (12.49)	342 (13.47)
	1FK7033-7	101 (3.98)	SP100S-MF2	90 (3.55)	32 (1.26)	9 (0.35)	120 (4.73)	230 (9.06)	58 (2.29)	30 (1.18)	10 (0.39)	311 (12.25)	336 (13.24)	336 (13.24)	361 (14.22)	336 (13.24)	361 (14.22)
48	1FK7043-7	76 (2.99)	SP075S-MF2	70 (2.76)	22 (0.87)	6.6 (0.26)	85 (3.35)	192 (7.56)	36 (1.42)	20 (0.79)	7 (0.28)	327 (12.88)	356 (14.03)	348 (13.71)	377 (14.85)	356 (14.03)	385 (15.17)
	1FK7043-7	101 (3.98)	SP100S-MF2	90 (3.55)	32 (1.26)	9 (0.35)	120 (4.73)	234 (9.22)	58 (2.29)	30 (1.18)	10 (0.39)	337 (13.28)	366 (14.42)	358 (14.11)	387 (15.25)	366 (14.42)	395 (15.56)
	1FK7043-7	141 (5.56)	SP140S-MF2	130 (5.12)	40 (1.58)	11 (0.43)	165 (6.50)	298 (11.74)	82 (3.23)	30 (1.18)	12 (0.47)	377 (14.85)	406 (16.00)	398 (15.68)	427 (16.82)	406 (16.00)	435 (17.14)
	1FK7044-7	101 (3.98)	SP100S-MF2	90 (3.55)	32 (1.26)	9 (0.35)	120 (4.73)	234 (9.22)	58 (2.29)	30 (1.18)	10 (0.39)	362 (14.26)	391 (15.41)	383 (15.09)	412 (16.23)	391 (15.41)	420 (16.55)
	1FK7044-7	141 (5.56)	SP140S-MF2	130 (5.12)	40 (1.58)	11 (0.43)	165 (6.50)	298 (11.74)	82 (3.23)	30 (1.18)	12 (0.47)	402 (15.84)	431 (16.98)	432 (17.02)	452 (17.81)	431 (16.98)	460 (18.12)
63	1FK7061-7	101 (3.98)	SP100S-MF2	90 (3.55)	32 (1.26)	9 (0.35)	120 (4.73)	252 (9.93)	58 (2.29)	30 (1.18)	10 (0.39)	349 (13.75)	392 (15.44)	372 (14.66)	415 (16.35)	381 (15.01)	424 (16.71)
	1FK7061-7	141 (5.56)	SP140S-MF2	130 (5.12)	40 (1.58)	11 (0.43)	165 (6.50)	305 (12.02)	82 (3.23)	30 (1.18)	12 (0.47)	378 (14.89)	421 (16.59)	401 (15.80)	444 (17.49)	410 (16.15)	453 (17.85)
	1FK7064-7	141 (5.56)	SP140S-MF2	130 (5.12)	40 (1.58)	11 (0.43)	165 (6.50)	305 (12.02)	82 (3.23)	30 (1.18)	12 (0.47)	442 (17.41)	485 (19.11)	465 (18.32)	508 (20.02)	474 (18.68)	517 (20.37)
80	1FK7085-7	182 (7.17)	SP180S-MF2	160 (6.30)	55 (2.17)	13.5 (0.53)	215 (8.47)	355 (13.99)	82 (3.23)	30 (1.18)	15 (0.59)	504 (19.84)	547 (21.54)	526 (20.71)	569 (22.40)	535 (21.06)	577 (22.72)
	1FK7085-7	212 (8.35)	SP210-MF2	180 (7.09)	75 (2.96)	17 (0.67)	250 (9.85)	397 (15.64)	105 (4.14)	38 (1.50)	17 (0.67)	515 (20.29)	557 (21.95)	537 (21.16)	580 (22.85)	546 (21.51)	588 (23.17)
	1FK7086-7	182 (7.17)	SP180S-MF2	160 (6.30)	55 (2.17)	13.5 (0.53)	215 (8.47)	355 (13.99)	82 (3.23)	30 (1.18)	15 (0.59)	504 (19.84)	547 (21.54)	526 (20.71)	569 (22.40)	535 (21.06)	577 (22.72)
	1FK7086-7	212 (8.35)	SP210-MF2	180 (7.09)	75 (2.96)	17 (0.67)	250 (9.85)	397 (15.64)	105 (4.14)	38 (1.50)	17 (0.67)	515 (20.29)	557 (21.95)	537 (21.16)	580 (22.85)	546 (21.51)	588 (23.17)

1FK703.-7
1FK704.-7
1FK706.-7
1FK708.-7

¹⁾ The 1FK7033 motor cannot be supplied with a basic absolute encoder.

8.4 1FK7 motors with planetary gearbox LP+

1FK7 Compact motors without/with DRIVE-CLiQ, with planetary gearbox LP+, single-stage

For motor		Dimensions in mm (in)															
Shaft height	Type	DIN IEC	Resolver				Basic absolute encoder (EnDat) ¹⁾ Incremental encoder sin/cos 1 V _{pp}				Absolute encoder (EnDat)				l E	d D	a ₁ P
			without brake		with brake		without brake		with brake		without brake		with brake				
			k LB	K -	k LB	K -	k LB	K -	k LB	K -	k LB	K -	k LB	K -			
1FK7 Compact with LP+ planetary gearbox, single-stage, type IM B5, natural cooling, with connector, with/without brake																	
28	1FK7022-5		153 (6.02)	216 (8.50)	175 (6.89)	238 (9.37)	178 (7.01)	241 (9.49)	200 (7.87)	263 (10.35)	178 (7.01)	241 (9.49)	200 (7.87)	263 (10.35)	20 (0.79)	9 (0.35)	-
	1FK7022-5		153 (6.02)	236 (9.29)	175 (6.89)	258 (10.16)	178 (7.01)	261 (10.28)	200 (7.87)	283 (11.14)	178 (7.01)	261 (10.28)	200 (7.87)	283 (11.14)			
36	1FK7032-5		150 (5.91)	240 (9.45)	175 (6.89)	265 (10.43)	175 (6.89)	265 (10.43)	200 (7.87)	290 (11.42)	175 (6.89)	290 (11.42)	200 (7.87)	290 (11.42)	30 (1.18)	14 (0.55)	92 (3.62)
	1FK7034-5		175 (6.89)	265 (10.43)	200 (7.87)	290 (11.42)	200 (7.87)	290 (11.42)	225 (8.86)	315 (12.40)	200 (7.87)	290 (11.42)	225 (8.86)	315 (12.40)			
48	1FK7040-5		135 (5.31)	247 (9.72)	164 (6.46)	276 (10.87)	155 (6.10)	267 (10.51)	184 (7.24)	296 (11.65)	164 (6.46)	276 (10.87)	193 (7.60)	305 (12.01)	40 (1.57)	19 (0.75)	120 (4.72)
	1FK7042-5		162 (6.38)	274 (10.79)	191 (7.52)	303 (11.93)	183 (7.20)	295 (11.61)	212 (8.35)	324 (12.76)	191 (7.52)	303 (11.93)	220 (8.66)	332 (13.07)			
63	1FK7060-5		157 (6.18)	297 (11.69)	200 (7.87)	340 (13.39)	180 (7.09)	320 (12.60)	223 (8.78)	363 (14.29)	188 (7.40)	328 (12.91)	231 (9.09)	371 (14.61)	50 (1.97)	24 (0.94)	155 (6.10)
	1FK7063-5		202 (7.95)	342 (13.46)	245 (9.65)	385 (15.16)	225 (8.86)	365 (14.37)	268 (10.55)	408 (16.06)	233 (9.17)	373 (14.69)	276 (10.87)	416 (16.38)			
80	1FK7080-5		156 (6.14)	325 (12.80)	184 (7.24)	353 (13.90)	179 (7.05)	347 (13.66)	206 (8.11)	375 (14.76)	187 (7.36)	355 (13.98)	215 (8.46)	384 (15.12)	58 (2.28)	32 (1.26)	186 (7.32)
	1FK7083-5		194 (7.64)	363 (14.29)	245 (9.65)	414 (16.30)	217 (8.54)	385 (15.16)	268 (10.55)	436 (17.17)	225 (8.86)	393 (15.47)	276 (10.87)	444 (17.48)			
Shaft height	Type	Planetary gearbox Type	D ₁	D ₂	D ₃	D ₄	D ₅	L ₂	L ₃	L ₄	L ₅	L ₈	L ₉	L ₁₀	L ₁₆		
			-	-	-	-	-	-	-	-	-	-	-	-	-	-	
28	1FK7022-5	LP050-M01	50 (1.97)	35 (1.38)	12 (0.47)	44 (1.73)	M4	18 (0.71)	4 (0.16)	7 (0.28)	8 (0.31)	14 (0.55)	4 (0.16)	50 (1.97)	88 (3.46)		
	1FK7022-5	LP070-M01	70 (2.76)	52 (2.05)	16 (0.63)	62 (2.44)	M5	28 (1.10)	5 (0.20)	8 (0.31)	10 (0.39)	18 (0.71)	5 (0.20)	70 (2.76)	119 (4.69)		
36	1FK7032-5	LP070-M01	70 (2.76)	52 (2.05)	16 (0.63)	62 (2.44)	M5	28 (1.10)	5 (0.20)	8 (0.31)	10 (0.39)	18 (0.71)	5 (0.20)	70 (2.76)	126 (4.96)		
	1FK7034-5																
48	1FK7040-5	LP090-M01	90 (3.54)	68 (2.68)	22 (0.87)	80 (3.15)	M6	36 (1.42)	5 (0.20)	10 (0.39)	12 (0.47)	25 (0.98)	6 (0.24)	90 (3.54)	158 (6.22)		
	1FK7042-5																
63	1FK7060-5	LP120-M01	120 (4.72)	90 (3.54)	32 (1.26)	108 (4.25)	M8	58 (2.28)	6 (0.24)	12 (0.47)	16 (0.63)	35 (1.38)	10 (0.39)	120 (4.72)	210 (8.27)		
	1FK7063-5																
80	1FK7080-5	LP155-M01	155 (6.10)	120 (4.72)	40 (1.57)	140 (5.51)	M10	82 (3.23)	8 (0.31)	15 (0.59)	20 (0.79)	43 (1.69)	12 (0.47)	150 (5.91)	266 (10.47)		
	1FK7083-5																

1FK702.-5
1FK703.-5
1FK704.-5
1FK706.-5
1FK708.-5

¹⁾ 1FK7022 and 1FK703. motors cannot be supplied with a basic absolute encoder.

Dimension drawings

8.4 1FK7 motors with planetary gearbox LP+

For motor		Dimensions in mm (in)															
Shaft height	Type	Resolver						Basic absolute encoder (EnDat) Incremental encoder sin/cos 1 V _{pp}				Absolute encoder (EnDat)					
		without brake		with brake		without brake		with brake		without brake		with brake			I E	d D	a ₁ P
		k LB	K -	k LB	K -	k LB	K -	k LB	K -	k LB	K -	k LB	K -				
1FK7 Compact with LP+ planetary gearbox, single-stage, type IM B5, natural cooling, with connector, with/without brake																	
100	1FK7100-5	185 (7.28)	374 (14.72)	204 (8.03)	393 (15.47)	208 (8.19)	396 (15.59)	227 (8.94)	415 (16.34)	216 (8.50)	404 (15.91)	235 (9.25)	423 (16.65)	80 (3.15)	38 (1.50)	240 (9.45)	
	1FK7101-5	211 (8.31)	400 (15.75)	240 (9.45)	429 (16.89)	234 (9.21)	422 (16.61)	263 (10.35)	452 (17.80)	242 (9.53)	430 (16.93)	271 (10.67)	460 (18.11)				
	1FK7103-5	237 (9.33)	426 (16.77)	266 (10.47)	455 (17.91)	260 (10.24)	448 (17.64)	289 (11.38)	478 (18.82)	268 (10.55)	456 (17.95)	297 (11.69)	486 (19.13)				
	1FK7105-5	289 (11.38)	478 (18.82)	318 (12.52)	507 (19.96)	312 (12.28)	500 (19.69)	341 (13.43)	530 (20.87)	320 (12.60)	508 (20.00)	349 (13.74)	538 (21.18)				
Shaft height	Type	Planetary gearbox Type	D ₁	D ₂	D ₃	D ₄	D ₅	L ₂	L ₃	L ₄	L ₅	L ₈	L ₉	L ₁₀	L ₁₆		
			-	-	-	-	-	-	-	-	-	-	-	-	-	-	-
100	1FK710-5	LP155-M01	155 (6.10)	120 (4.72)	40 (1.57)	140 (5.51)	M10	82 (3.23)	8 (0.31)	15 (0.59)	20 (0.79)	43 (1.69)	12 (0.47)	150 (5.91)	286 (11.26)		
1FK710 -5																	

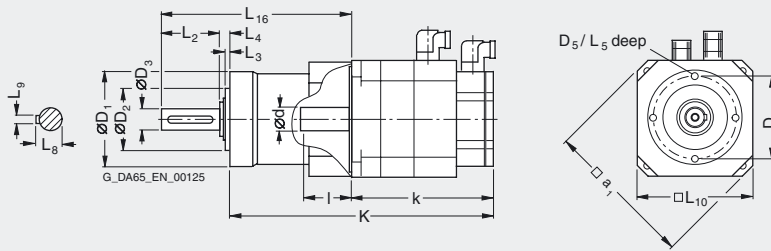

1FK7 High Dynamic motors without/with DRIVE-CLiQ with planetary gearbox LP+, single-stage

For motor		Dimensions in mm (in)															
Shaft height	Type	DIN IEC	Resolver				Basic absolute encoder (EnDat) ¹⁾ Incremental encoder sin/cos 1 V _{pp}				Absolute encoder (EnDat)				I E	d D	a ₁ P
			without brake		with brake		without brake		with brake		without brake		with brake				
			k LB	K -	k LB	K -	k LB	K -	k LB	K -	k LB	K -	k LB	K -			
1FK7 High Dynamic with LP+ planetary gearbox, single-stage, type IM B5, natural cooling, with connector, with/without brake																	
36	1FK7033-7		170 (6.69)	260 (10.24)	195 (7.68)	285 (11.22)	195 (7.68)	285 (11.22)	220 (8.66)	310 (12.20)	195 (7.68)	285 (11.22)	220 (8.66)	310 (12.20)	30 (1.18)	14 (0.55)	92 (3.62)
48	1FK7043-7		191 (7.52)	303 (11.93)	220 (8.66)	332 (13.07)	212 (8.35)	324 (12.76)	240 (9.45)	352 (13.86)	220 (8.66)	332 (13.07)	249 (9.80)	361 (14.21)	40 (1.57)	19 (0.75)	120 (4.72)
	1FK7044-7		216 (8.50)	328 (12.91)	245 (9.65)	357 (14.06)	237 (9.33)	349 (13.74)	265 (10.43)	377 (14.84)	245 (9.65)	357 (14.06)	274 (10.79)	386 (15.20)			
63	1FK7061-7		185 (7.28)	325 (12.80)	228 (8.98)	368 (14.49)	208 (8.19)	348 (13.70)	251 (9.88)	391 (15.39)	217 (8.54)	357 (14.06)	260 (10.24)	400 (15.75)	50 (1.97)	24 (0.94)	155 (6.10)
	1FK7064-7		249 (9.80)	389 (15.31)	292 (11.50)	432 (17.01)	272 (10.71)	412 (16.22)	315 (12.40)	455 (17.91)	281 (11.06)	421 (16.57)	324 (12.76)	464 (18.27)			
80	1FK7085-7		261 (10.28)	430 (16.93)	304 (11.97)	473 (18.62)	284 (11.18)	453 (17.83)	326 (12.83)	495 (19.49)	292 (11.50)	461 (18.15)	335 (13.19)	504 (19.84)	58 (2.28)	32 (1.26)	186 (7.32)
	1FK7086-7																
Shaft height	Type	Planetary gearbox Type	D ₁	D ₂	D ₃	D ₄	D ₅	L ₂	L ₃	L ₄	L ₅	L ₈	L ₉	L ₁₀	L ₁₆		
			-	-	-	-	-	-	-	-	-	-	-	-	-	-	
36	1FK7033-7	LP070-M01	70 (2.76)	52 (2.05)	16 (0.63)	62 (2.44)	M5	28 (1.10)	5 (0.20)	8 (0.31)	10 (0.39)	18 (0.71)	5 (0.20)	70 (2.76)	126 (4.96)		
48	1FK7043-7	LP090-M01	90 (3.54)	68 (2.68)	22 (0.87)	80 (3.15)	M6	36 (1.42)	5 (0.20)	10 (0.39)	12 (0.47)	25 (0.98)	6 (0.24)	90 (3.54)	158 (6.22)		
	1FK7044-7																
63	1FK7061-7	LP120-M01	120 (4.72)	90 (3.54)	32 (1.26)	108 (4.25)	M8	58 (2.28)	6 (0.24)	12 (0.47)	16 (0.63)	35 (1.38)	10 (0.39)	120 (4.72)	210 (8.27)		
	1FK7064-7																
80	1FK7085-7	LP155-M01	155 (6.10)	120 (4.72)	40 (1.57)	140 (5.51)	M10	82 (3.23)	8 (0.31)	15 (0.59)	20 (0.79)	43 (1.69)	12 (0.47)	150 (5.91)	266 (10.47)		
	1FK7086-7																

1FK7033-7
1FK704-7
1FK706-7
1FK708-7

¹⁾ 1FK7033 motor cannot be supplied with a basic absolute encoder.

Note

All page numbers shown in the selection and ordering data tables and the technical data tables refer to catalog D21.1.

9.1 Dimensioning the gearbox

9.1.1 Overview

- If the gearbox oil is in contact with the motor flange, then suitable shaft and flange seals must be selected.
- Technical data should be obtained from the catalogs of the gearbox manufacturers and similar sources.
- The following influencing parameters should be taken into consideration:
 - acceleration torque, permanent torque, number of cycles, cycle type, permissible input speed, mounting position, torsional backlash, torsional stiffness, and radial and axial forces.
 - Worm gearboxes are only conditionally suitable for reversing operation with servo applications.

9.1.2 Dimensioning for S3 duty for non-ventilated systems

When engineering geared drive systems you can use the motor characteristic without reduction. Please note the permissible maximum torque and the permissible gearbox input speed.

$$M_{\text{Mot}} = M_{\text{out}} / (i \cdot \eta_G)$$

The motor and gearbox are assigned as follows: $M_{\text{max, gear}} \geq M_{0(100K)} \cdot i \cdot f$

$M_{\text{max, gear}}$	Max. permissible drive torque
$M_{0(100K)}$	Motor static torque
i	Gear ratio
f	Supplementary factor $f = f_1 \cdot f_2$
	$f_1 = 2$ for motor accelerating torque
	$f_2 = 1$ for ≤ 1000 gearbox switching cycles / h
	$f_2 > 1$ for > 1000 switching cycles / h (refer to the gearbox catalog)
	e.g. $f_2 = 1.5$ for 3000 switching cycles / h
	$f_2 = 1.8$ for 5000 switching cycles / h
	$f_2 = 2.0$ for 8000 switching cycles / h

Notice

Switching cycles can also be superimposed vibration! The supplementary factor (f2) is then not sufficient when dimensioning the gearbox and gearboxes may fail.

The complete system should be optimized so that the higher-level vibration is minimized.

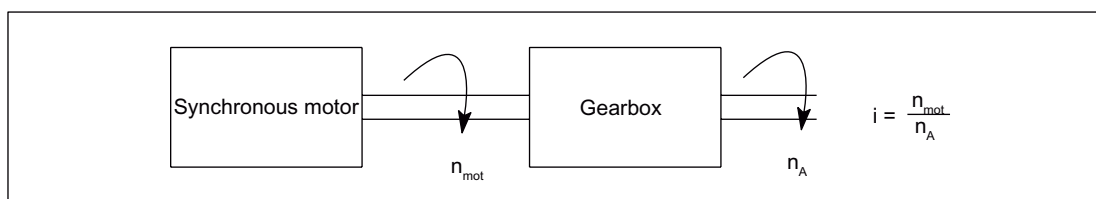

Figure 9-1 Dimensioning the gearbox

The load torque and the required start-up velocity define the gearbox output torque, the output speed and therefore the output power.

The required drive power is calculated from this:

$$P_{out} [W] = P_{mot} [W] \cdot \eta_G = (\pi/30) \cdot M_{mot} [Nm] \cdot n_{mot} [RPM] \cdot \eta_G$$

9.1.3 Dimensioning for S1 duty for non-ventilated systems

The gearbox itself generates heat due to friction and acts as a thermal barrier preventing heat from being dissipated through the motor flange. This is the reason that the torque must be reduced for S1 duty.

The required motor torque is calculated as follows:

$$M_{Mot} = \sqrt{ \left(\frac{M_{ab}}{i \cdot \eta_G} + M_v \right)^2 - M_v^2 } \quad \text{mit} \quad M_v = a \cdot b \cdot \frac{n_{Mot}}{60} (1 - \eta_G) \cdot \frac{k_T^2}{R_{Strw}}$$

M_v	Calculated "torque loss"
a	$\pi/3$ for 1FK□ motors supplied with sinusoidal current
b	0.5 weighting factor for gearbox losses (without dimensions)
n_{mot}	Motor speed [RPM]
k_T	Torque constant [Nm/A]
$R_{ph.}$	Motor phase resistance when warm [Ω] = 1.4 $R_{ph.}$ (catalog)
M_{out}	Gear drive torque [Nm]
i	Gearbox ratio ($i > 1$)
η_G	Gearbox efficiency
P_{mot}	Motor power [W]
P_{out}	Gearbox output power [W]
M_{mot}	Motor torque [Nm]
π	3,1416

9.1.4 Change to the S1 characteristic when a gearbox is mounted

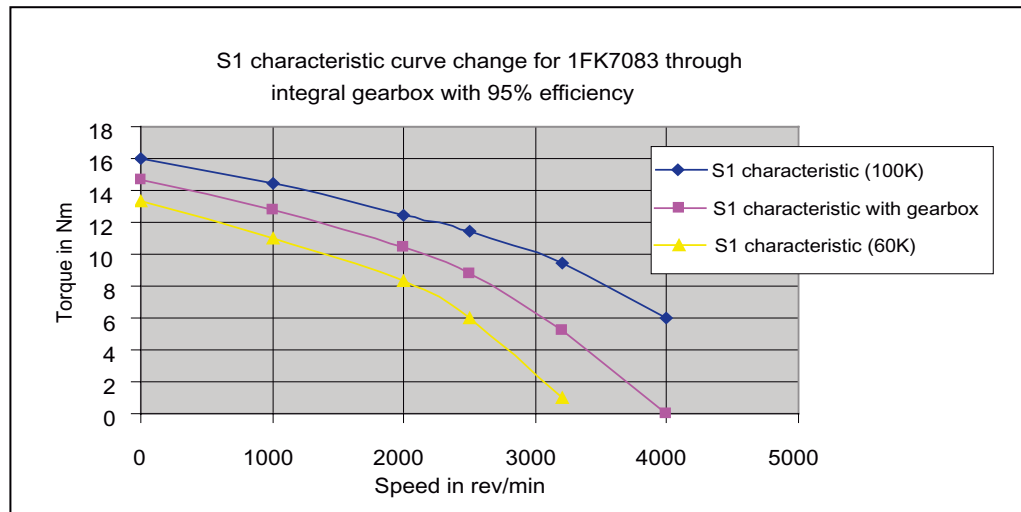

Figure 9-2 Example: 1FK7083 with angled gearbox (characteristic)

Information for additional characteristics: $S1_{\text{gearbox}} = S1_{100K} - (S1_{100K} - S1_{60K}) / 2$

9.1.5 Startup procedure

During commissioning, it should be assumed that an increased current will be drawn due to the lubrication characteristics (inadequate distribution of grease and oil) and the fact that the shaft sealing ring is being run-in.

9.1.6 Motors with mounted gearbox

The gearboxes assigned to the individual motors as well as the gearbox ratios, available for these motor-gearbox combinations are listed in the selection tables of the motor-specific Sections. When making a selection, the maximum permissible input speed of the gearbox must be observed (this is the same as the maximum motor speed).

The motor-gearbox combinations, listed in the selection tables, are mainly intended for positioning duty (S3). The manufacturer must be contacted if the motors are to be used in continuous duty at high speeds.

1FK7 synchronous motors can be supplied ex works (Siemens) complete with a flangemounted planetary gearbox.

9.2 Motors with planetary gears

9.2.1 Characteristics of SP+ series

Overview

1FK7 motors can be combined with planetary gears to form compact coaxial drive units. The gearboxes are flanged directly to the drive end of the motors.

When selecting the gearboxes, ensure that the permissible speed of the gearbox is not exceeded by the maximum speed of the motor. In the case of high operating frequencies, allowance must be made for the withstand ratio f_z .

The frictional losses of the gearbox must always be taken into account when engineering geared drives.

The gearboxes are only available in a non-balanced design.

Benefits

- High efficiency:
 - > 97% single-stage
 - > 94% 2-stage
- Minimum torsional play:
 - ≤ 4 arcmin single-stage
 - ≤ 6 arcmin 2-stage
- Power transmission from the central sun wheel to the planetary pinions
- No shaft deflections in the planetary pinions set due to the symmetrical force distribution
- Very low moment of inertia and hence short acceleration times of the motors
- Output shaft bearings dimensioned for high cantilever and axial loads with preloaded tapered-roller bearings
- The gearboxes are connected to the motor shaft via an integrated clamping hub A plain motor shaft end is necessary for this purpose. Radial eccentricity tolerance N in accordance with DIN 42955 and vibration severity grade A in accordance with EN 60034-14 are sufficient. The motor flange is adapted via adapter plates.
- Output shaft of gearbox exactly coaxial with the motor
- The gearboxes are sealed (seal between the gearbox and motor) and filled with oil at the factory. They are lubricated for life and sealed. Gearboxes of frame sizes SP060S to SP180S are suitable for all mounting positions.
- For gearboxes, sizes SP210 and SP240 the quantity of oil in the gearbox depends on the mounting position. The mounting position has to be specified when ordering.
- Gearbox degree of protection IP65 (IP64 for frame sizes SP210 and SP240)
- Small dimensions
- Low weight

Integration

1FK702□ to 1FK710□ synchronous motors are available ex factory (SIEMENS) complete with flange-mounted planetary gear.

The gearboxes assigned to the individual motors and gear ratios i available for these motor/gearbox combinations are listed in the selection table. When making a selection, the maximum permissible input speed of the gearbox must be observed (this is the same as the maximum motor speed).

The motor/gearbox combinations listed in the selection tables are mainly intended for cyclic operation S3 - 60% (ON period $\leq 60\%$ and ≤ 20 min). Reduced maximum motor speeds and output torques apply for use in S1 continuous duty (ON period $> 60\%$ or > 20 min).

The gearbox temperature may not exceed $+90$ °C

1FK7 synchronous motors must be designed with keyless motor shaft end, degree of protection IP65 and anthracite paint finish for mounting onto the gearbox.

9.2.1.1 Selection and ordering data

Selection and ordering data, single-stage planetary gear, SP+ series

Motor Natural cooling	Planetary gearbox single-stage			Available gear ratio <i>i</i>				Max. perm. motor speed S3-60%	Max. perm. output torque S3-60%	Max. perm. radial output shaft load ¹⁾	Max. perm. axial output shaft load ¹⁾
	Type	Tor- sional back- lash	Weight of gearbox, approx.	4	5	7	10				
Type	Type	arcmin	kg/lb					n_{G1} (n_1) rpm	M_{G2} (T_{2B}) Nm/lb _f -ft	F_r (F_{2Rmax}) N/lb _f	F_a (F_{2Amax}) N/lb _f
1FK7022	SP 060S-MF1	≤4	1.9/4.2	✓	✓	✓	✓	6000	40/29.5 (32/23.6 for $i = 10$)	2700/ 606.99	2400/ 539.54
1FK7032				✓	✓	✓	✓				
1FK7033				✓	✓	✓	✓				
1FK7034				✓	✓	✓	✓				
1FK7040	SP 075S-MF1	≤4	3.9/8.6	✓	✓	✓	✓	6000	110/81.1 (90/66.3 for $i = 10$)	4000/ 899.24	3350/ 753.11
1FK7042				✓	✓	✓	✓				
1FK7043				✓	✓	✓	✓				
1FK7044				✓	✓	✓	✓				
1FK7060	SP 100S-MF1	≤3	7.7/17.0	✓	✓	✓	✓	4500	300/221.1 (225/165.8 for $i = 10$)	6300/ 1416.30	5650/ 1270.18
1FK7061				✓	✓	✓	✓				
1FK7063				✓	✓	✓	✓				
1FK7064				✓	✓	✓	✓				
1FK7080	SP 140S-MF1	≤3	17.2/37.9	✓	✓	✓	✓	4000	600/442.2 (480/353.8 for $i = 10$)	9450/ 2124.45	9870/ 2218.87
1FK7082				✓	✓	✓	✓				
1FK7083				✓	✓	✓	✓				
1FK7085				✓	✓	✓	✓				
1FK7086				✓	✓	✓	✓				
1FK7100	SP 180S-MF1	≤3	34/75.0	✓	✓	✓	✓	3500	1100/810.7	14700/ 3304.71	14150/ 3181.06
1FK7101				✓	✓	✓	✓				
1FK7103				✓	✓	✓	✓				
1FK7105				✓	✓	✓	–				
1FK7105	SP 210-MF1 ²⁾	≤4	53/116.9	–	–	–	✓	2200	2720/2004.6	18000/ 4046.58	22500/ 5058.23

Order codes

Gearbox shaft with fitted key
 Gearbox shaft without fitted key

J02 J03 J05 J09
 J22 J23 J25 J29

Ordering data 1FK7...-A.71-1..
 J ■ ■

■ 5-Z

G w/o holding brake
 H with holding brake

Order No. of the motor with identifier "-Z" and
 order code for mounting the planetary gearbox assigned to the motor
 Prerequisite for mounting planetary gearboxes:
 Plain motor shaft end IP65 degree of protection, anthracite paint finish

¹⁾ In reference to the motor shaft center.

²⁾ With this version, the oil filling quantities depend on the mounting position. In the case of a vertical mounting position, the 12th position in the Order No. should be "9" and a further order code also has to be specified: 1FK7...-A.7 9-1..5-Z J.. + M1 ■

H mounting position IM V1
 G mounting position IM V3

Technical data, single-stage planetary gear, SP+ series

Planetary gearbox with 1FK7 motor, natural cooling									
single-stage Type	Gear ratio	Motor speed		Moments of inertia of gearbox (referred to the motor)					
		Continuous duty S1 ¹⁾		1FK702.	1FK703.	1FK704.	1FK706.	1FK708.	1FK710.
		n_{N1}	$M_{N2} (T_{2N})$	J_1	J_1	J_1	J_1	J_1	J_1
		rpm	Nm/ lb _f -ft	kgcm ² / lb _f -in-s ²	kgcm ² / lb _f -in-s ²	kgcm ² / lb _f -in-s ²	kgcm ² / lb _f -in-s ²	kgcm ² / lb _f -in-s ²	kgcm ² / lb _f -in-s ²
SP 060S-MF1	4	3300	26/19.2	0.16/0.00014	0.24/0.00021	–	–	–	–
	5	3300	26/19.2	0.13/0.00012	0.22/0.00019	–	–	–	–
	7	4000	26/19.2	0.11/0.00010	0.19/0.00017	–	–	–	–
	10	4000	17/12.5	0.10/0.00009	0.18/0.00016	–	–	–	–
SP 075S-MF1	4	2900	75/55.3	–	–	0.94/0.00083	–	–	–
	5	2900	75/55.3	–	–	0.83/0.00073	–	–	–
	7	3100	75/55.3	–	–	0.73/0.00065	–	–	–
	10	3100	52/38.3	–	–	0.67/0.00059	–	–	–
SP 100S-MF1	4	2500	180/132.7	–	–	–	3.65/0.00323	–	–
	5	2500	175/129	–	–	–	2.99/0.00265	–	–
	7	2800	170/125.3	–	–	–	2.81/0.00249	–	–
	10	2800	120/88.4	–	–	–	2.58/0.00228	–	–
SP 140S-MF1	4	2100	360/265.3	–	–	–	–	14.26/0.01262	–
	5	2100	360/265.3	–	–	–	–	13.06/0.01156	–
	7	2600	360/265.3	–	–	–	–	11.97/0.01059	–
	10	2600	220/162.1	–	–	–	–	11.39/0.01008	–
SP 180S-MF1	4	1500	750/552.8	–	–	–	–	–	45.08/0.03990
	5	1500	750/552.8	–	–	–	–	–	36.37/0.03219
	7	2300	750/552.8	–	–	–	–	–	28.57/0.02528
	10	2300	750/552.8	–	–	–	–	–	24.40/0.02159
SP 210-MF1	4	1200	1000/737	–	–	–	–	–	75.80/0.06708
	5	1200	1000/737	–	–	–	–	–	63.50/0.05620
	7	1700	1000/737	–	–	–	–	–	52.90/0.04682
	10	1700	1000/737	–	–	–	–	–	47.10/0.04168
SP 240-MF1	4	1000	1700/1252.9	–	–	–	–	–	–
	5	1000	1700/1252.9	–	–	–	–	–	–
	7	1500	1700/1252.9	–	–	–	–	–	–
	10	1500	1700/1252.9	–	–	–	–	–	–

¹⁾ The limit values in the table apply for S1 continuous duty (ON time >60% or >20 min) for a maximum gearbox temperature of +90 °C (194 °F)

Selection and ordering data, 2-stage planetary gear, SP+ series

Motor Natural cooling	Planetary gearbox two-stage		Available gear ratio <i>i</i>					Max. perm. motor speed S3-60%	Max. perm. output torque S3-60%	Max. perm. radial output shaft load ¹⁾	Max. perm. axial output shaft load ¹⁾	
	Type	Tor- sional back- lash arcmin	Weight of gearbox, approx. kg/lb	16	20	28	40					50
								n_{G1} (n_1) rpm	M_{G2} (T_{2B}) Nm/lb _f -ft	F_r (F_{2Rmax}) N/lb _f	F_a (F_{2Amax}) N/lb _f	
1FK7022	SP 060S-MF2	≤6	2/4.4	✓	✓	✓	–	–	6000	40/29.5	2700/ 606.99	2400/ 539.54
1FK7032				✓	✓	–	–	–				
1FK7033				✓	✓	–	–	–				
1FK7022	SP 075S-MF2	≤6	3.6/7.9	–	–	–	✓	✓	6000	110/81.1	4000/ 899.24	3350/ 753.11
1FK7032				–	–	✓	✓	✓				
1FK7033				–	–	✓	✓	✓				
1FK7034				–	–	✓	✓	✓				
1FK7040				✓	✓	✓	–	–				
1FK7042				✓	✓	–	–	–				
1FK7043				✓	–	–	–	–				
1FK7040	SP 100S-MF2	≤5	7.9/17.4	–	–	–	✓	✓	4500	300/221.1	6300/ 1416.30	5650/ 1270.18
1FK7042				–	✓	✓	✓	✓				
1FK7043				–	✓	✓	✓	✓				
1FK7044				–	✓	✓	–	–				
1FK7060				✓	✓	–	–	–				
1FK7061				✓	✓	–	–	–				
1FK7044	SP 140S-MF2	≤5	17/37.5	–	–	–	–	✓	4000	600/442.2	9450/ 2124.45	9870/ 2218.87
1FK7060				–	–	–	✓	✓				
1FK7061				–	–	✓	✓	✓				
1FK7063				✓	✓	–	–	–				
1FK7064				✓	✓	–	–	–				
1FK7080				✓	✓	–	–	–				
1FK7082				✓	✓	–	–	–				
1FK7083				✓	✓	–	–	–				
1FK7085				✓	✓	–	–	–				
1FK7086				✓	✓	–	–	–				
1FK7100				✓	✓	–	–	–				
1FK7101				✓	✓	–	–	–				
1FK7103				✓	–	–	–	–				
1FK7063	SP 180S-MF2	≤5	36.4/ 80.3	–	–	–	✓	✓	4000	1100/810.7	14700/ 3304.71	14150/ 3181.06
1FK7064				–	–	–	✓	✓				
1FK7080				–	–	–	–	✓				
1FK7082				–	–	✓	✓	–				
1FK7083				–	–	✓	–	–				
1FK7085				–	–	–	–	–				
1FK7086				–	–	–	–	–				
1FK7100				–	–	–	–	–				
1FK7101				–	–	–	–	–				
1FK7103				–	–	–	–	–				
1FK7105				–	–	–	–	–				
1FK7082	SP 210-MF2 ²⁾	≤6	50/ 110.3	–	–	–	–	✓	3500	1900/1400.3	18000/ 4046.58	22500/ 5058.23
1FK7083				–	–	–	–	✓				
1FK7085				–	–	✓	✓	–				
1FK7086				–	–	✓	–	–				
1FK7100				–	–	–	–	✓				
1FK7101				–	–	–	–	–				
1FK7103				–	–	–	–	–				
1FK7105				–	–	–	–	–				
1FK7101	SP 240-MF2 ²⁾	≤6	70/ 154.4	–	–	–	✓	✓	3500	3400/2505.8	27000/ 6069.87	27800/ 6249.72
1FK7103				–	–	–	✓	–				
1FK7105				–	–	–	✓	–				

Order codes						
Gearbox shaft <u>with</u> fitted key		J12	J13	J15	J16	J17
Gearbox shaft <u>without</u> fitted key		J32	J33	J35	J36	J37

Ordering data 1FK7...-A.71-1.. ■ 5-Z Order No. of the motor with identifier “-Z” and order code for mounting the planetary gear-
 J ■ ■ Plain motor shaft end/radial eccentricity tolerance N and vibration severity grade N/IP65
 G w/o holding brake degree of protection
 H with holding brake

¹⁾ In reference to the motor shaft center.
²⁾ With this version, the oil filling quantities depend on the mounting position. In the case of a vertical mounting position, the 12th position in the Order No. should be “9” and a further order code also has to be specified: 1FK7...-A.7 9-1..5-Z J.. + M1 ■
 H mounting position IM V1
 G mounting position IM V3

Technical data, 2-stage planetary gear, SP+ series

Planetary gearbox with 1FK7 motor, natural cooling									
two-stage Type	Gear ratio	Motor speed	Output torque	Moments of inertia of gearbox (referred to the motor)					
				Continuous duty S1 ¹⁾		1FK702.	1FK703.	1FK704.	1FK706.
		n_{N1} rpm	$M_{N2} (T_{2N})$ Nm/ lb _f -ft	J_1 kgcm ² / lb _f -in-s ²	J_1 kgcm ² / lb _f -in-s ²	J_1 kgcm ² / lb _f -in-s ²	J_1 kgcm ² / lb _f -in-s ²	J_1 kgcm ² / lb _f -in-s ²	J_1 kgcm ² / lb _f -in-s ²
SP 060S-MF2	16	4400	26/19.2	0.08/0.00007	0.18/0.00016	–	–	–	–
	20	4400	26/19.2	0.07/0.00006	0.17/0.00015	–	–	–	–
	28	4400	26/19.2	0.06/0.00005	0.16/0.00014	–	–	–	–
	40	4400	26/19.2	0.06/0.00005	0.16/0.00014	–	–	–	–
	50	4800	26/19.2	0.06/0.00005	0.16/0.00014	–	–	–	–
SP 075S-MF2	16	3500	75/55.3	0.17/0.00015	0.25/0.00022	0.68/0.00060	–	–	–
	20	3500	75/55.3	0.14/0.00012	0.22/0.00019	0.65/0.00058	–	–	–
	28	3500	75/55.3	0.11/0.00010	0.19/0.00017	0.62/0.00055	–	–	–
	40	3500	75/55.3	0.10/0.00009	0.18/0.00016	0.61/0.00054	–	–	–
	50	3800	75/55.3	0.10/0.00009	0.18/0.00016	0.61/0.00054	–	–	–
SP 100S-MF2	16	3100	180/132.7	–	–	0.96/0.00085	2.60/0.00230	–	–
	20	3100	180/132.7	–	–	0.84/0.00074	2.48/0.00219	–	–
	28	3100	180/132.7	–	–	0.73/0.00065	2.36/0.00209	–	–
	40	3100	180/132.7	–	–	0.67/0.00059	2.31/0.00204	–	–
	50	3500	175/129	–	–	0.66/0.00058	2.30/0.00204	–	–
SP 140S-MF2	16	2900	360/265.3	–	–	2.79/0.00247	3.61/0.00319	9.60/0.00850	–
	20	2900	360/265.3	–	–	2.26/0.00200	3.08/0.00273	9.07/0.00803	–
	28	2900	360/265.3	–	–	1.84/0.00163	2.66/0.00235	8.65/0.00766	–
	40	2900	360/265.3	–	–	1.58/0.00140	2.39/0.00212	8.39/0.00743	–
	50	3200	360/265.3	–	–	1.57/0.00139	2.38/0.00211	8.37/0.00741	–
SP 180S-MF2	16	2700	750/552.8	–	–	–	10.24/0.00906	15.83/0.01401	14.36/0.01271
	20	2700	750/552.8	–	–	–	8.48/0.00750	14.08/0.01246	12.06/0.01067
	28	2700	750/552.8	–	–	–	6.90/0.00611	12.49/0.01105	11.02/0.00975
	40	2700	750/552.8	–	–	–	6.06/0.00536	11.65/0.01031	10.17/0.00900
	50	2900	750/552.8	–	–	–	5.98/0.00529	11.58/0.01025	10.10/0.00894
SP 210-MF2	16	2100	1000/737	–	–	–	–	36.30/0.03212	37.40/0.03310
	20	2100	1000/737	–	–	–	–	34.50/0.03053	35.60/0.03151
	28	2100	1000/737	–	–	–	–	32.30/0.02859	33.40/0.02956
	40	2300	1000/737	–	–	–	–	23.10/0.02044	24.30/0.02151
	50	2300	1000/737	–	–	–	–	21.90/0.01938	23.00/0.02035
SP 240-MF2	16	1900	1700/1252.9	–	–	–	–	–	48.40/0.04283
	20	1900	1700/1252.9	–	–	–	–	–	44.20/0.03912
	28	1900	1700/1252.9	–	–	–	–	–	38.60/0.03416
	40	2100	1700/1252.9	–	–	–	–	–	33.60/0.02974
	50	2100	1700/1252.9	–	–	–	–	–	30.60/0.02708

¹⁾ The limit values in the table apply for S1 continuous duty (ON time >60% or >20 min) for a maximum gearbox temperature of +90 °C (194 °F).

9.2.2 Characteristics of the LP+ series

Overview

1FK7 motors can be combined with planetary gearboxes to form compact coaxial drive units. The gearboxes are flanged directly to the drive end of the motors.

When selecting the gearboxes, ensure that the permissible speed of the gearbox is not exceeded by the maximum speed of the motor. In the case of high operating frequencies, allowance must be made for the withstand ratio f_z .

The frictional losses of the gearbox must always be taken into account when engineering geared drives.

The gearboxes are only available in a non-balanced design and with fitted key.

Benefits

- High efficiency, single-stage: > 97 %
- Torsional backlash, single-stage: ≤ 12 arcmin
- Power transmission from the central sun wheel to the planetary pinions
- No shaft deflections in the planetary pinions set due to the symmetrical force distribution
- The gearboxes are connected to the motor shaft via an integrated clamping hub. A plain motor shaft end is necessary for this purpose. Radial eccentricity tolerance N in accordance with DIN 42955 and vibration severity grade A in accordance with EN 60034-14 are sufficient. The motor flange is adapted via adapter plates.
- Output shaft of gearbox exactly coaxial with the motor
- The gearboxes can be mounted in any position
- The gearboxes are sealed (seal between gearbox and motor) and filled with grease in the factory. They are lubricated and sealed for their service life.
- Gear unit degree of protection IP64
- Small dimensions
- Low weight

Integration

1FK702□ to 1FK710□ synchronous motors can be supplied ex works (SIEMENS) complete with a flange-mounted planetary gearbox.

The gearboxes assigned to the individual motors as well as the gearbox ratios, available for these motor-gearbox combinations are listed in the Selection and ordering data table.

When making a selection, the maximum permissible input speed of the gearbox must be observed (this is the same as the maximum motor speed).

The motor/gearbox combinations listed in the selection tables are mainly intended for cyclic operation S3 - 60% (ON period \leq 60% and \leq 20 min). Reduced maximum motor speeds and output torques apply for use in S1 continuous duty (ON period $>$ 60% or $>$ 20 min).

The gearbox temperature may not exceed 90 °C

1FK7 synchronous motors should be designed with keyless motor shaft end/radial eccentricity tolerance N, degree of protection IP65 and anthracite paint finish for mounting onto the gearbox.

9.2 Motors with planetary gears

9.2.2.1 Selection and Ordering Data

Motor Natural cooling	Planetary gearbox single-stage Torsional backlash ≤ 12 arcmin		Available gear ratios <i>i</i>		Max. perm. input speed	Max. perm. output torque		Max. perm. radial force on output shaft ¹⁾	Moment of inertia of gearboxes
	Type	Weight of gearbox, approx. kg/lb	5	10	n_{G1} rpm	M_{G2} at $i = 5$ Nm/lb _f -ft	M_{G2} at $i = 10$ Nm/lb _f -ft	F_r N/lb _f	J_G at $i = 5/10$ 10^{-4} kgm ² /lb _f -in-s ²
1FK7022	LP 050-M01	0.75/1.65	✓	–	8000	12/8.8	10.5/7.7	650/146.13	0.055/0.00005
1FK7022	LP 070-M01	2.0/4.41	–	✓	6000	35/25.8	32/23.6	1450/325.97	0.28/0.0002
1FK7032			✓	✓					
1FK7033			✓	✓					
1FK7034			✓	✓					
1FK7040	LP 090-M01	4.0/8.82	✓	✓	6000	90/66.3	80/59	2400/539.54	1.77/0.0016
1FK7042			✓	✓					
1FK7043			✓	✓					
1FK7044			✓	✓					
1FK7060	LP 120-M01	8.6/18.96	✓	✓	4800	220/162.1	200/147.4	4600/1034.13	5.42/0.0048
1FK7061			✓	✓					
1FK7063			✓	✓					
1FK7064			✓	–					
1FK7080	LP 155-M01	17/37.49	✓	✓	3600	450/331.7	350/258	7500/1686.87	25.73/0.0228
1FK7082			✓	✓					
1FK7083			✓	✓					
1FK7085			✓	–					
1FK7086			✓	–					
1FK7100			✓	✓					
1FK7101			✓	–					
1FK7103			✓	–					
1FK7105			✓	–					

Order code		
Gearbox shaft <u>with</u> fitted key	V40	V42

Ordering data 1FK7...-A.71-.. ■ 3-Z ■ ■ ■ ■
■ G w/o holding brake
■ H with holding brake

Order No. of the motor with identifier “-Z” and order code for mounting the planetary gearbox assigned to the motor
 Precondition:
 Plain motor shaft end

Continuous duty S1

Continuous duty is permissible at rated speed and rated torque. The gearbox temperature may not exceed 90 °C (194 °F).

Planetary gearbox single-stage Torsional backlash ≤ 12 arcmin	Rated input speed	Rated output torque	
Type	n_{N1} rpm	M_{N2} at $i = 5$ Nm/lb _f -ft	M_{N2} at $i = 10$ Nm/lb _f -ft
LP 050-M01	4000	5.7/4.2	–
LP 070-M01	3700	18/13.3	16.5/12.2
LP 090-M01	3400	45/33.2	40/29.5
LP 120-M01	2600	110/81.1	100/73.7
LP 155-M01	2000	320/235.8	190/140

¹⁾ Referred to the center of the output shaft at 100 rpm.

9.2.3 Compact geared motor 1FK7 DYA

Overview

The 1FK7 DYA compact geared motor combines electrical and mechanical components in the smallest space possible. This mechatronic unit consists of a permanently excited 1FK7 series synchronous motor and a directly mounted single-stage planetary gear.

1FK7 DYA compact geared motors can be combined with the SINAMICS S120 drive system to create a powerful system with high functionality. The integrated encoder system for speed and position control can be selected depending on the application. Other options are possible, such as the integrated holding brake and a coat of paint in some other RAL color.

The 1FK7 DYA compact geared motors with protection level IP 64 are designed for operation without external cooling and the heat is dissipated over the motor surface.

The integrated planetary gears have high maximum torques and permit high radial and axial forces at the shaft end.



Figure 9-3 Compact Geared Motor 1FK7 DYA

Benefits

Space-saving installation due to the high power density of the motor and integration of the planetary gear directly into the motor bearing bracket. Mounting to the machine is greatly simplified by this and the logistics are reduced to a minimum.

Mounting in configurations IM B 5 and IM B14 is possible.

High dynamics due to reduced own inertial torque. This allows short cycle times to be achieved.

Maintenance-free. Suitable for S1 continuous duty.

High degree of positioning accuracy due to the negligible mechanical torsional backlash of < 8 arcmin.

Mechanical compatibility with regard to IM B14 flange and shaft end for the LP+ planetary gear.

Power connection via plug, signal connection via plug or DRIVE-CLiQ (for SINAMICS S120).

Applications

In general machinery design, any place where coaxial drive units are used, such as in:

- packaging machines
- Wood, glass and ceramic working machines
- Plastic injection and foil stretching machines
- Handling systems
- Machine tools
- All kinds of auxiliary axes

Selection and ordering data

Rated speed	Rated power	Maximum rotational speed	Maximum torque	Static torque	Rated torque	Available gear ratio	Compact geared motor		Number of pole pairs	Rotor moment of inertia (without brake)	Rotor moment of inertia (with brake)
n_{2N}	P_2	n_{2max}	M_{2max}	M_{20}	M_{2N}	i	Order No.	Order code		J	J
rpm	kW/HP	rpm	Nm/lb _f -ft	Nm/lb _f -ft	Nm/lb _f -ft					10 ⁻⁴ kgm ² / lb _f -in-s ²	10 ⁻⁴ kgm ² / lb _f -in-s ²
370	0.37/ 0.50	600	32/23.6	11/8.1	9.5/7	10	1FK7032-5AK71- 1 ■ ■ 3-Z	A03	3	0.75/ 0.0007	0.83/ 0.0007
740	0.5/ 0.67	1200	32/23.6	7.5/5.5	6.5/4.8	5	1FK7034-5AK71-1 ■ ■ 3-Z	A00	3	1.04/ 0.0009	1.12/ 0.0010
340	0.45/ 0.60	600	49/36.1	15/11.1	12.5/9.2	10	1FK7040-5AK71-1 ■ ■ 3-Z	A13	4	2.3/ 0.0020	3/ 0.0027
680	0.71/ 0.95	1200	51/37.6	13/9.6	10/7.4	5	1FK7042-5AK71-1 ■ ■ 3-Z	A10	4	3.6/ 0.0032	4.3/ 0.0038
260	1.25/ 1.68	480	175/129	57/42	46/33.9	10	1FK7060-5AH71-1 ■ ■ 3-Z	A73	4	10.3/ 0.0091	12.5/ 0.0111
520	1.74/ 2.33	960	170/125.3	51/37.6	32/23.6	5	1FK7063-5AH71-1 ■ ■ 3-Z	A70	4	17.4/ 0.0154	19.6/ 0.0173
200	1.47/ 1.97	360	242/178.4	76/56	70/51.6	10	1FK7080-5AH71-1 ■ ■ 3-Z	A83	4	28.7/ 0.0254	31.8/ 0.0281
400	1.88/ 2.52	720	233/171.7	68/50.1	45/33.2	5	1FK7083-5AH71-1 ■ ■ 3-Z	A80	4	41/ 0.0363	49.6/ 0.0439
Encoder systems for motors without DRIVE-CLiQ interface:			Incremental encoder sin/cos 1 V _{pp} 2048 pulses/revolution Absolute encoder EnDat 2048 pulses/rev. ¹⁾ (not for 1FK703) Abs. encoder EnDat 512 pulses/rev. (not for 1FK704 to 1FK708) Basic absolute encoder 32 pulses/revolution (not for 1FK703) Multi-pole resolver 2-pole resolver				A E H G S T				
Encoder systems for motors with DRIVE-CLiQ interface:			Incremental encoder sin/cos 1 V _{pp} 2048 pulses/revolution Absolute encoder EnDat 2048 pulses/rev. ¹⁾ (not for 1FK703) Abs. encoder EnDat 512 pulses/rev. (not for 1FK704 to 1FK708) Basic absolute encoder 32 pulses/revolution (not for 1FK703) Multi-pole resolver 2-pole resolver				D F L K U P				
Shaft extension: Fitted key and keyway Fitted key and keyway			Radial eccentricity: Tolerance N Tolerance N		Holding brake: without with			U V			
Degree of protection:			IP64, color RAL 7016 (anthracite)						3		

Selection and ordering data

Motor type (continued)	Weight		Static current I_0 at M_0 $\Delta T = 100\text{ K}$	Maximum current I_{max}	SINAMICS Motor Module		Power cable with complete shield Motor terminal (and brake terminal) via power connector		
	(without brake) kg/lb	(with brake) kg/lb			Rated output current I_N	Order No. For complete order no., see "SINAMICS S120"	Power con- nector Size	Motor cable cross section ²⁾ mm ²	Order no. Pre-assembled cable
1FK7032-5AK71-...	4.11/ 9.06	4.47/ 9.86	1.7	5	3	6SL312 ■ - ■ TE13-0AA0	1	4 x 1.5	6FX ■ 002-5 ■ S01-....
1FK7034-5AK71-...	5.01/ 11.05	5.37/ 11.84	1.9	7.9	3	6SL312 ■ - ■ TE13-0AA0	1	4 x 1.5	6FX ■ 002-5 ■ S01-....
1FK7040-5AK71-...	6.6/ 14.55	7.61/ 16.78	2.3	7.4	3	6SL312 ■ - ■ TE13-0AA0	1	4 x 1.5	6FX ■ 002-5 ■ S01-....
1FK7042-5AK71-...	7.91/ 17.44	8.62/ 19.01	4.4	14.9	5	6SL312 ■ - ■ TE15-0AA0	1	4 x 1.5	6FX ■ 002-5 ■ S01-....
1FK7060-5AH71-...	13.9/ 30.65	15/ 33.08	6.2	19	9	6SL312 ■ - ■ TE21-0AA0	1	4 x 1.5	6FX ■ 002-5 ■ S01-....
1FK7063-5AH71-...	17.6/ 38.81	19/ 41.90	12	41	18	6SL312 ■ - ■ TE21-8AA0	1	4 x 1.5	6FX ■ 002-5 ■ S01-....
1FK7080-5AH71-...	23.4/ 51.60	24.6/ 54.24	7.4	24	9	6SL312 ■ - ■ TE21-0AA0	1	4 x 1.5	6FX ■ 002-5 ■ S01-....
1FK7083-5AH71-...	28.6/ 63.06	31.2/ 68.80	15	48	18	6SL312 ■ - ■ TE21-8AA0	1	4 x 1.5	6FX ■ 002-5 ■ S01-....

Cooling: Internal air cooling External air cooling	0 1
Motor Module: Single Motor Module Double Motor Module	1 2
Power cable model: MOTION-CONNECT 800 MOTION-CONNECT 500	8 5
Without brake cores With brake cores	C D
For length code as well as power and signal cables, see "MOTION-CONNECT cables and connections".

1) If the absolute encoder is used, M_{rated} is reduced by 10%.
 2) The current carrying capacity of the Motor Module corresponds to IEC 60204-1 for type of routing C under continuous operation conditions with an ambient air temperature of +40 °C (104 °F), designed for I_0 (100 K), PVC/PUR-insulated cable.

9.2.3.1 Mounting options

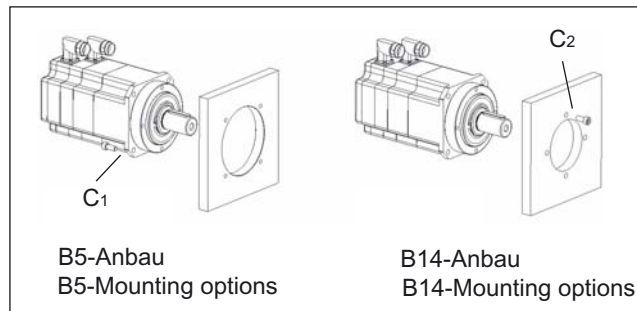

Figure 9-4 Mounting options

Table 9-1 Screw size with metric threads

Motor	Screw size for B5 installation C ₁	Screw size for B14 installation C ₂
1FK7 DYA 070	4 x M6	4 x M5
1FK7 DYA 090	4 x M6	4 x M6
1FK7 DYA 120	4 x M8	4 x M8
1FK7 DYA 155	4 x M10	4 x M10

9.3 Motors with helical and bevel gearboxes

9.3.1 Characteristics

Overview

The 1FK7 servo gear motors are preassembled as a complete unit and supplied with a gearbox filled with oil. The range of types includes:

- Helical geared motors with 9 gearbox sizes
- Offset shaft geared motors with 5 gearbox sizes
- Bevel geared motors with 8 gearbox sizes, and
- Worm gear motors with 5 gearbox sizes

A wide range of mounting possibilities can be implemented with the numerous options.

The 1FK7 servo gear motors are designed for operation without external cooling and the generated heat loss is dissipated through the motor surface. 1FK7 servo gear motors can be combined with the SINAMICS S120 drive system to create a powerful system with high functionality. Integrated encoder systems for speed and position can be selected depending on the application just as for 1FK7 servomotors.

Benefits

1FK7 servo gear motors offer:

- Extremely compact design as a result of the direct mounting (because there is no coupling cage between the motor and gearbox)
- Maintenance-free and lubricated for life (exception: worm gearbox)
- High efficiency
- Low torsional backlash
- Low running noise thanks to the low running noise due to the helical gearing
- High endurance gearing (exception, worm gearbox)
- Suitable for cyclic operation with alternating load and continuous operation
- Favorably-priced solution when compared to planetary geared motors

Area of application

1FK7 servo gear motors are ideally suited for applications in general machine construction for basic positioning tasks and servo-quality continuous auxiliary drives, for example in:

- Packaging machines
- High-bay racking units
- Wood, glass, ceramic and stone working machines
- Beverage filling plants
- Conveyor belts

Technical features

Helical geared motor	
Nominal ratio	$i_{\text{norm } 0} = 3.8 \text{ to } 70$
Output torque	$M_2 = 46 \text{ Nm to } 1370 \text{ Nm}$
Max. perm. accelerating torque	$M_{2\text{max}} = 65 \text{ Nm to } 4140 \text{ Nm}$
Torsional backlash	10 arcmin to 20 arcmin
Efficiency	94% to 96%
Mechanical options	Solid shaft with key, flange, mounting feet, tapped hole group

Offset shaft geared motor	
Nominal ratio	$i_{\text{norm } 0} = 4,3 \text{ to } 35$
Output torque	$M_2 = 58 \text{ Nm to } 529 \text{ Nm}$
Max. perm. accelerating torque	$M_{2\text{max}} = 120 \text{ Nm to } 1100 \text{ Nm}$
Torsional backlash	10 arcmin to 11 arcmin
Efficiency	94% to 96%
Mechanical options	Solid shaft, hollow shaft with key, hollow shaft with tensioning element/shrink disk, flange, mounting feet, tapped hole group

Bevel geared motor	
Nominal ratio	$i_{\text{norm } 0} = 4 \text{ to } 76$
Output torque	$M_2 = 89 \text{ Nm to } 1280 \text{ Nm}$
Max. perm. accelerating torque	$M_{2\text{max}} = 135 \text{ Nm to } 4650 \text{ Nm}$
Torsional backlash	10 arcmin to 12 arcmin
Efficiency	94% to 96%
Mechanical options	Solid shaft, hollow shaft with key, hollow shaft with tensioning element/shrink disk, flange, mounting feet, tapped hole group

Worm geared motor	
Nominal ratio	$i_{\text{norm } 0} = 9,2 \text{ to } 70$
Output torque	$M_2 = 80 \text{ Nm to } 430 \text{ Nm}$
Max. perm. accelerating torque	$M_{2\text{max}} = 96 \text{ Nm to } 720 \text{ Nm}$
Mechanical options	Solid shaft, hollow shaft with key, hollow shaft with tensioning element/shrink disk, flange, mounting feet, tapped hole group, torque bracket

Configuring geared servo motors with the CAD CREATOR

The "CAD CREATOR" tool can be used to configure the geared servomotors and as a guide to selection and ordering. This tool contains the relevant data and all dimension sheets.

The CAD CREATOR is available on CD-ROM (order number 6SL3075-0AA00-0AG0) and as an Internet application.

You will find additional information on the Internet at: <http://www.siemens.com/cad-creator>

9.3.2 Selection and ordering data

Explanations of designations in the tables "Selection and ordering data"		
Code	Unit	Description
P_2	[kW]	Mechanical power output at the gearbox shaft (in S3 duty)
n_2	[1/min]	Gearbox output speed referred to the input speed of the motor of $n_1 = 3000$ rpm for a horizontal gearbox shaft output
M_2	[Nm]	Rated gearbox output torque in S3 duty
M_{2max}	[Nm]	Max. permissible accelerating torque of the gearbox
i_{nom}		Nominal gearbox ratio (approximate value as decimal number)
i_{exact}		Exact gearbox ratio (specified as a fraction for parameter entry in the drive converter)
F_{rperm}	[N]	Max. perm. cantilever force on gear shaft end
f_B		Gearbox overload factor (quotient between the max. permissible accelerating torque and stall torque of the motor and ratio)
Gearbox size		Designation of gearbox type and size C = Helical gear F = Offset shaft gear K = Bevel gear S = Worm gear
SH		Motor frame size (1FK7 motors are available in frame sizes 36, 48, 63, 80 and 100)
Order codes		The Order codes define the gearbox type, size, ratio and mechanical design
Weight	[kg]	Total weight of the geared motor

Selection and ordering data for helical gear motors

Output (S3 -60%)	Output speed	Rated output torque	Max. permissible acceleration torque	Nominal ratio	Exact ratio	Cantilever force gearbox shaft extension	Overload factor	
P_2 kW/HP	n_2 rpm	M_2 Nm/lb _f -ft	M_{2max} Nm/lb _f -ft	i_{nom}	i_{exact}	F_{rperm} N/lb _f	f_B	
0.30/0.40	782	3.63/2.7	19/14	3.8	441/115	560/125.89	4.2	
	476	5.96/4.4	29/21.4	6.3	2035/323	660/148.37	3.9	
	291	9.74/7.2	51/37.6	10.5	1421/138	778/174.90	4.2	
	192	14.8/10.9	72/53.1	15.5	1595/102	894/200.98	3.9	
	129	22/16.2	65/47.9	23	325/14	1020/229.31	2.4	
	86	33.1/24.4	65/47.9	35	1261/36	1170/263.03	1.6	
0.41/0.55	782	5.02/3.7	36/26.5	3.8	441/115	560/125.89	6.0	
	476	8.25/6.1	55/40.5	6.3	2035/323	660/148.37	5.6	
	291	13.5/9.9	72/53.1	10.5	1421/138	778/174.90	4.5	
	192	20.5/15.1	72/53.1	15.5	1595/102	894/200.98	3.0	
	128	30.8/22.7	138/101.7	24	1035/44	1456/327.32	3.8	
	86	45.9/33.8	138/101.7	35	2700/77	1663/373.86	2.5	
0.79/1.06	782	9.67/7.1	36/26.5	3.8	441/115	560/125.89	3.2	
	476	15.9/11.7	55/40.5	6.3	2035/323	660/148.37	3.0	
	291	26/19.2	72/53.1	10.5	1421/138	778/174.90	2.4	
	191	39.6/29.2	138/101.7	15.5	377/24	1273/286.18	3.0	
	192	39.4/29	72/53.1	15.5	1595/102	894/200.98	1.6	
	128	59.3/43.7	138/101.7	24	1035/44	1456/327.32	2.0	
1.43/1.92	782	17.5/12.9	50/36.9	3.8	441/115	560/125.89	2.2	
	476	28.7/21.2	59/43.5	6.3	2035/323	660/148.37	1.6	
	511	26.8/19.8	102/75.2	5.9	47/8	917/206.15	3.0	
	291	46.9/34.6	72/53.1	10.5	1421/138	778/174.90	1.2	
	289	47.3/34.9	138/101.7	10.5	841/81	1109/267.52	2.3	
	191	71.6/52.8	138/101.7	15.5	377/24	1273/286.18	1.5	
1.42/1.90	782	69.7/51.4	230/169.5	15.5	703/46	1775/399.04	2.6	
	128	107/78.9	138/101.7	25	1035/44	1456/327.32	1.0	
	128	107/78.9	350/258	24	845/36	3045/684.55	2.6	
	1.42/1.90	85	160/117.9	230/169.5	35	1372/39	2343/526.73	1.1
	1.43/1.92	86	159/117.2	550/405.4	35	975/28	5961/1340.09	2.7
	60	227/167.3	400/294.8	50	2736/55	3911/879.23	1.4	
1.44/1.93	60	229/168.8	600/442.2	50	1305/26	6734/1513.87	2.1	
	43	319/235.1	550/405.4	70	559/8	7519/7690.35	1.4	
	43	319/235.1	850/626.5	70	10075/144	9229/2074.77	2.1	

Selection and ordering data for helical gear motors

	Gearbox size	Motor frame size	Helical geared motors		Order codes		Type of construction mounting position	Total weight, approx. kg/lb
			Order No.		Gearbox type	Type		
		SH						
	C002	36	1FK7032-5AK71-1	■ ■ 5-Z	D01	G ■ ■	H ■ ■	8.6/19.0
	C002	36	1FK7032-5AK71-1	■ ■ 5-Z	D02	G ■ ■	H ■ ■	8.6/19.0
	C002	36	1FK7032-5AK71-1	■ ■ 5-Z	D03	G ■ ■	H ■ ■	8.6/19.0
	C002	36	1FK7032-5AK71-1	■ ■ 5-Z	D04	G ■ ■	H ■ ■	8.6/19.0
	C002	36	1FK7032-5AK71-1	■ ■ 5-Z	D05	G ■ ■	H ■ ■	8.6/19.0
	C002	36	1FK7032-5AK71-1	■ ■ 5-Z	D06	G ■ ■	H ■ ■	8.6/19.0
	C002	36	1FK7032-5AK71-1	■ ■ 5-Z	D07	G ■ ■	H ■ ■	8.6/19.0
	C102	36	1FK7032-5AK71-1	■ ■ 5-Z	D18	G ■ ■	H ■ ■	13.5/29.8
	C002	48	1FK7040-5AK71-1	■ ■ 5-Z	D01	G ■ ■	H ■ ■	9.4/20.7
	C002	48	1FK7040-5AK71-1	■ ■ 5-Z	D02	G ■ ■	H ■ ■	9.4/20.7
	C002	48	1FK7040-5AK71-1	■ ■ 5-Z	D03	G ■ ■	H ■ ■	9.4/20.7
	C002	48	1FK7040-5AK71-1	■ ■ 5-Z	D04	G ■ ■	H ■ ■	9.4/20.7
	C102	48	1FK7040-5AK71-1	■ ■ 5-Z	D15	G ■ ■	H ■ ■	14.3/31.5
	C002	48	1FK7040-5AK71-1	■ ■ 5-Z	D05	G ■ ■	H ■ ■	9.4/20.7
	C102	48	1FK7040-5AK71-1	■ ■ 5-Z	D16	G ■ ■	H ■ ■	14.3/31.5
	C002	48	1FK7040-5AK71-1	■ ■ 5-Z	D06	G ■ ■	H ■ ■	9.4/20.7
	C102	48	1FK7040-5AK71-1	■ ■ 5-Z	D17	G ■ ■	H ■ ■	14.3/31.5
	C002	48	1FK7042-5AF71-1	■ ■ 5-Z	D01	G ■ ■	H ■ ■	10.7/23.6
	C002	48	1FK7042-5AF71-1	■ ■ 5-Z	D02	G ■ ■	H ■ ■	10.7/23.6
	C002	48	1FK7042-5AF71-1	■ ■ 5-Z	D03	G ■ ■	H ■ ■	10.7/23.6
	C102	48	1FK7042-5AF71-1	■ ■ 5-Z	D14	G ■ ■	H ■ ■	15.6/34.4
	C002	48	1FK7042-5AF71-1	■ ■ 5-Z	D04	G ■ ■	H ■ ■	10.7/23.6
	C102	48	1FK7042-5AF71-1	■ ■ 5-Z	D15	G ■ ■	H ■ ■	15.6/34.4
	C102	48	1FK7042-5AF71-1	■ ■ 5-Z	D16	G ■ ■	H ■ ■	15.6/23.6
	C102	48	1FK7042-5AF71-1	■ ■ 5-Z	D17	G ■ ■	H ■ ■	15.6/23.6
	C002	63	1FK7060-5AF71-1	■ ■ 5-Z	D01	G ■ ■	H ■ ■	13.4/29.6
	C002	63	1FK7060-5AF71-1	■ ■ 5-Z	D02	G ■ ■	H ■ ■	13.4/29.6
	C102	63	1FK7060-5AF71-1	■ ■ 5-Z	D12	G ■ ■	H ■ ■	18.3/40.4
	C002	63	1FK7060-5AF71-1	■ ■ 5-Z	D03	G ■ ■	H ■ ■	13.4/29.6
	C102	63	1FK7060-5AF71-1	■ ■ 5-Z	D13	G ■ ■	H ■ ■	18.3/40.4
	C102	63	1FK7060-5AF71-1	■ ■ 5-Z	D14	G ■ ■	H ■ ■	18.3/40.4
	C202	63	1FK7060-5AF71-1	■ ■ 5-Z	D24	G ■ ■	H ■ ■	22.3/49.2
	C102	63	1FK7060-5AF71-1	■ ■ 5-Z	D15	G ■ ■	H ■ ■	18.3/40.4
	C302	63	1FK7060-5AF71-1	■ ■ 5-Z	D35	G ■ ■	H ■ ■	27.4/60.4
	C202	63	1FK7060-5AF71-1	■ ■ 5-Z	D26	G ■ ■	H ■ ■	22.3/49.2
	C402	63	1FK7060-5AF71-1	■ ■ 5-Z	D46	G ■ ■	H ■ ■	37.6/82.9
	C302	63	1FK7060-5AF71-1	■ ■ 5-Z	D37	G ■ ■	H ■ ■	27.4/60.4
	C402	63	1FK7060-5AF71-1	■ ■ 5-Z	D47	G ■ ■	H ■ ■	37.6/82.9
	C402	63	1FK7060-5AF71-1	■ ■ 5-Z	D48	G ■ ■	H ■ ■	37.6/82.9
	C502	63	1FK7060-5AF71-1	■ ■ 5-Z	D58	G ■ ■	H ■ ■	49.2/108.5
Encoder systems: Motors without DRIVE-CLiQ interface		Incremental encoder sin/cos 1 V _{pp} Absolute encoder EnDat 2048 pulses/rev. (shaft height 48 and higher) Absolute encoder EnDat 512 pulses/rev. (only shaft height 36) Basic abs. encoder EnDat 32 pulses/rev. (shaft height 48 and higher) Res., multi-pole (pole no. = pole no. for motor) Resolver, 2-pole	A E H G S T					
Encoder systems: Motors with DRIVE-CLiQ interface		Incremental encoder sin/cos 1 V _{pp} Absolute encoder EnDat 2048 pulses/rev. (shaft height 48 and higher) Absolute encoder EnDat 512 pulses/rev. (only shaft height 36) Basic abs. encoder EnDat 32 pulses/rev. (shaft height 48 and higher) Res., multi-pole (pole no. = pole no. for motor) Resolver, 2-pole	D F L K U P					
Holding brake:		Motor without holding brake Motor with holding brake	U V					
Order codes for type, type of construction and mounting position, refer to page 3/86								

9.3 Motors with helical and bevel gearboxes

Selection and ordering data for helical gear motors

Output (S3 -60%)	Output speed	Rated output torque	Max. permissible acceleration torque	Nominal ratio	Exact ratio	Cantilever force gearbox shaft extension	Overload factor
P_2 kW/HP	n_2 rpm	M_2 Nm/lb _f -ft	M_{2max} Nm/lb _f -ft	i_{nom}	i_{exact}	$F_{rpermiss}$ N/lb _f	f_B
2.23/2.99	782	27.2/20	50/36.9	3.8	441/115	560/125.89	1.2
	511	41.6/30.7	102/75.2	5.9	47/8	917/206.15	1.6
2.22/2.98	289	73.5/54.2	138/101.7	10.5	841/81	1109/249.31	1.2
	196	108/79.6	230/169.5	15.5	703/46	1775/399.04	1.4
	128 86	166/122.3 247/182	350/258 550/405.4	23 35	845/36 975/28	3045/684.55 5961/1340.09	1.4 1.5
2.23/2.99	60	355/261.6	600/442.2	50	1305/26	6734/1513.87	1.1
	43	495/364.8	850/626.5	70	10075/144	9229/2074.77	1.1
2.07/2.78	773	25.6/18.9	101/74.4	3.9	1363/351	799/125.89	3.3
2.08/2.79	511	38.8/28.6	115/84.8	5.9	47/8	917/206.15	2.5
2.07/2.78	289	68.5/50.5	138/101.7	10.5	847/81	1109/249.31	1.7
	196	101/74.4	230/169.5	15.5	703/46	1775/399.04	1.9
2.08/2.79	191	104/76.6	138/101.7	15.5	377/24	1273/286.18	1.1
	128	155/114.2	350/258	23	845/36	3045/684.55	1.9
2.07/2.78	127	156/115	230/169.5	24	637/27	2051/461.09	1.3
	86	230/169.5	550/405.4	35	975/28	5961/1340.09	2.0
2.08/2.79	86	231/170.2	350/258	35	1261/36	3479/782.11	1.3
2.07/2.78	60	329/242.5	920/678	50	1943/39	8241/1852.66	2.4
2.09/2.80	44	454/334.6	1380/1017.1	69	620/9	12344/2775.05	2.6
3.20/4.29	773	39.5/29.1	101/74.4	3.9	1363/351	799/125.89	1.7
	772	39.6/29.2	154/113.5	3.9	486/125	1125/252.91	2.5
	511	59.8/44.1	115/84.8	5.9	47/8	917/206.15	1.3
	518	59/43.5	176/129.7	5.8	666/115	1284/288.66	2.0
	320 322	95.6/70.5 94.8/69.9	230/169.5 350/258	9.4 9.3	2450/261 3575/384	1509/339.24 2237/502.90	1.6 2.4
3.19/4.28	193	158/116.4	400/294.8	15.5	544/35	2654/596.65	1.7
3.18/4.26	190	160/117.9	600/442.2	16	63/4	4576/1028.73	2.5
3.19/4.28	128	238/175.4	550/405.4	23	1495/64	5219/1173.28	1.5
	128	238/175.4	850/626.5	23	1495/64	6402/1439.23	2.3
3.20/4.29	86	355/261.6	550/405.4	35	975/28	5961/1340.09	1.0
	86	355/261.6	1380/1017.1	35	1360/39	9838/2211.68	2.6
3.19/4.28	60	507/373.7	920/678	50	1943/39	2265/509.19	1.2
3.20/4.29	64	477/351.5	1971/1452.6	47	515/11	14923/3354.84	2.7
3.23/4.33	44	702/517.4	1380/1017.1	69	620/9	12344/2775.05	1.3
3.19/4.28	43	708/521.8	2300/1695.1	70	765/11	17027/3827.84	2.1

Selection and ordering data for helical gear motors

Gearbox size	Motor frame size	Helical geared motors Order No.	Order codes Gearbox type	Type	Type of construction mounting position	Total weight, approx.	
						SH	kg/lb
C002	63	1FK7063-5AF71-1	■ ■ 5 - Z	D01	G ■ ■	H ■ ■	17.1/37.7
C102	63	1FK7063-5AF71-1	■ ■ 5 - Z	D12	G ■ ■	H ■ ■	22/48.5
C102	63	1FK7063-5AF71-1	■ ■ 5 - Z	D13	G ■ ■	H ■ ■	22/48.5
C202	63	1FK7063-5AF71-1	■ ■ 5 - Z	D24	G ■ ■	H ■ ■	26/57.3
C302	63	1FK7063-5AF71-1	■ ■ 5 - Z	D35	G ■ ■	H ■ ■	31.1/68.6
C402	63	1FK7063-5AF71-1	■ ■ 5 - Z	D46	G ■ ■	H ■ ■	41.3/91.1
C402	63	1FK7063-5AF71-1	■ ■ 5 - Z	D47	G ■ ■	H ■ ■	41.3/91.1
C502	63	1FK7063-5AF71-1	■ ■ 5 - Z	D58	G ■ ■	H ■ ■	52.9/116.6
C102	80	1FK7080-5AF71-1	■ ■ 5 - Z	D11	G ■ ■	H ■ ■	21.7/47.9
C102	80	1FK7080-5AF71-1	■ ■ 5 - Z	D12	G ■ ■	H ■ ■	21.7/47.9
C102	80	1FK7080-5AF71-1	■ ■ 5 - Z	D13	G ■ ■	H ■ ■	21.7/47.9
C202	80	1FK7080-5AF71-1	■ ■ 5 - Z	D24	G ■ ■	H ■ ■	25.9/56.7
C102	80	1FK7080-5AF71-1	■ ■ 5 - Z	D14	G ■ ■	H ■ ■	21.7/47.9
C302	80	1FK7080-5AF71-1	■ ■ 5 - Z	D35	G ■ ■	H ■ ■	30.8/67.9
C202	80	1FK7080-5AF71-1	■ ■ 5 - Z	D25	G ■ ■	H ■ ■	25.7/56.7
C402	80	1FK7080-5AF71-1	■ ■ 5 - Z	D46	G ■ ■	H ■ ■	41/90.4
C302	80	1FK7080-5AF71-1	■ ■ 5 - Z	D36	G ■ ■	H ■ ■	30.8/67.9
C502	80	1FK7080-5AF71-1	■ ■ 5 - Z	D57	G ■ ■	H ■ ■	52.6/116.0
C612	80	1FK7080-5AF71-1	■ ■ 5 - Z	D68	G ■ ■	H ■ ■	67.9/149.7
C102	80	1FK7083-5AF71-1	■ ■ 5 - Z	D11	G ■ ■	H ■ ■	26.9/59.3
C202	80	1FK7083-5AF71-1	■ ■ 5 - Z	D21	G ■ ■	H ■ ■	30.9/68.1
C102	80	1FK7083-5AF71-1	■ ■ 5 - Z	D12	G ■ ■	H ■ ■	26.9/59.3
C202	80	1FK7083-5AF71-1	■ ■ 5 - Z	D22	G ■ ■	H ■ ■	30.9/68.1
C202	80	1FK7083-5AF71-1	■ ■ 5 - Z	D23	G ■ ■	H ■ ■	30.9/68.1
C302	80	1FK7083-5AF71-1	■ ■ 5 - Z	D33	G ■ ■	H ■ ■	36/79.4
C302	80	1FK7083-5AF71-1	■ ■ 5 - Z	D34	G ■ ■	H ■ ■	36/79.4
C402	80	1FK7083-5AF71-1	■ ■ 5 - Z	D44	G ■ ■	H ■ ■	46.2/101.9
C402	80	1FK7083-5AF71-1	■ ■ 5 - Z	D45	G ■ ■	H ■ ■	46.2/101.9
C502	80	1FK7083-5AF71-1	■ ■ 5 - Z	D55	G ■ ■	H ■ ■	57.8/127.5
C402	80	1FK7083-5AF71-1	■ ■ 5 - Z	D46	G ■ ■	H ■ ■	46.2/101.9
C612	80	1FK7083-5AF71-1	■ ■ 5 - Z	D66	G ■ ■	H ■ ■	73.1/161.2
C502	80	1FK7083-5AF71-1	■ ■ 5 - Z	D57	G ■ ■	H ■ ■	57.8/127.5
C712	80	1FK7083-5AF71-1	■ ■ 5 - Z	D77	G ■ ■	H ■ ■	108.4/239.0
C612	80	1FK7083-5AF71-1	■ ■ 5 - Z	D68	G ■ ■	H ■ ■	73.1/161.2
C712	80	1FK7083-5AF71-1	■ ■ 5 - Z	D78	G ■ ■	H ■ ■	108.4/239.0
Encoder systems: Motors without DRIVE-CLiQ interface	Incremental encoder sin/cos 1 V _{pp} Absolute encoder EnDat 2048 pulses/rev. (shaft height 48 and higher) Absolute encoder EnDat 512 pulses/rev. (only shaft height 36) Basic abs. encoder EnDat 32 pulses/rev. (shaft height 48 and higher) Res., multi-pole (pole no.= pole no. for motor) Resolver, 2-pole	A E H G S T					
Encoder systems: Motors with DRIVE-CLiQ interface	Incremental encoder sin/cos 1 V _{pp} Absolute encoder EnDat 2048 pulses/rev. (shaft height 48 and higher) Absolute encoder EnDat 512 pulses/rev. (only shaft height 36) Basic abs. encoder EnDat 32 pulses/rev. (shaft height 48 and higher) Res., multi-pole (pole no.= pole no. for motor) Resolver, 2-pole	D F L K U P					
Holding brake:	Motor without holding brake Motor with holding brake	U V					
Order codes for type, type of construction and mounting position, refer to page 3/86							

Selection and ordering data for helical gear motors

Output (S3 -60%)	Output speed	Rated output torque	Max. permissible acceleration torque	Nominal ratio	Exact ratio	Cantilever force gearbox shaft extension	Overload factor
P_2 kW/HP	n_2 rpm	M_2 Nm/lb _f -ft	M_{2max} Nm/lb _f -ft	i_{nom}	i_{exact}	F_{rperm} N/lb _f	f_B
3.66/4.91	774	45.1/33.2	251/185	3.9	190/49	1671/375.66	3.7
	512	68.2/50.3	288/212.3	5.9	2584/441	1917/430.96	2.8
3.64/4.88	322	108/79.6	350/258	9.3	3575/384	2237/502.90	2.2
3.66/4.91	193	181/133.4	400/294.8	15.5	544/35	2654/596.65	1.5
3.64/4.88	190	183/134.9	600/442.2	16	63/4	4576/1028.73	2.2
3.65/4.89	128	272/200.5	850/626.5	23	1495/64	6402/1439.23	2.1
	128	272/200.5	550/405.4	23	1495/64	5219/1173.28	1.3
3.66/4.91	86	406/299.2	1380/1017.1	35	1360/39	9838/2211.68	2.3
3.65/4.89	66	528/389.1	1380/1017.1	45	136/3	1852/416.35	1.7
	64	545/401.7	2300/1695.1	47	515/11	14923/3354.84	2.8
3.70/4.96	44	802/591.1	4140/3051.2	69	620/9	23146/5203.45	3.4
4.73/6.34	774	58.3/43	251/185	3.9	190/49	1671/375.66	2.5
4.72/6.33	512	88.1/64.9	288/212.3	5.9	2584/441	1917/430.96	1.9
	324	139/102.4	550/405.4	9.3	3445/372	3834/861.92	2.3
	322	140/130.2	350/258	9.3	3575/384	2237/502.90	1.4
	191	236/173.9	920/678	15.5	377/24	5609/1260.96	2.2
	190	237/174.7	600/442.2	16	63/4	4576/1028.73	1.5
4.70/6.30	128	351/258.7	850/626.5	23	1495/64	6402/1439.23	1.4
4.71/6.32	120	375/276.4	1650/1216.1	25	5185/208	8797/1977.65	2.5
4.75/6.37	86	527/388.4	2300/1695.1	35	2700/77	13552/3046.63	2.5
4.71/6.32	66	682/502.6	1380/1017.1	45	136/3	10737/2413.78	1.2
4.72/6.33	64	704/518.8	2300/1695.1	47	515/11	14923/3354.84	1.9
4.77/6.40	44	1036/763.5	4140/3051.2	69	620/9	23146/5203.45	2.3

Selection and ordering data for helical gear motors

Gearbox size	Motor frame size	Helical geared motors Order No.	Order codes Gearbox type	Type	Type of construction mounting position	Total weight, approx.
						kg/lb
	SH					
C302	100	1FK7100-5AF71-1	■ ■ 5 - Z	D31	G ■ ■ H ■ ■	38.2/84.2
C302	100	1FK7100-5AF71-1	■ ■ 5 - Z	D32	G ■ ■ H ■ ■	38.2/84.2
C302	100	1FK7100-5AF71-1	■ ■ 5 - Z	D33	G ■ ■ H ■ ■	38.2/84.2
C302	100	1FK7100-5AF71-1	■ ■ 5 - Z	D34	G ■ ■ H ■ ■	38.2/84.2
C402	100	1FK7100-5AF71-1	■ ■ 5 - Z	D44	G ■ ■ H ■ ■	48.4/106.7
C502	100	1FK7100-5AF71-1	■ ■ 5 - Z	D55	G ■ ■ H ■ ■	60/132.3
C402	100	1FK7100-5AF71-1	■ ■ 5 - Z	D45	G ■ ■ H ■ ■	48.4/106.7
C612	100	1FK7100-5AF71-1	■ ■ 5 - Z	D66	G ■ ■ H ■ ■	75.3/166.0
C612	100	1FK7100-5AF71-1	■ ■ 5 - Z	D67	G ■ ■ H ■ ■	75.3/166.0
C712	100	1FK7100-5AF71-1	■ ■ 5 - Z	D77	G ■ ■ H ■ ■	110.6/243.9
C812	100	1FK7100-5AF71-1	■ ■ 5 - Z	D88	G ■ ■ H ■ ■	170.2/375.3
C302	100	1FK7101-5AF71-1	■ ■ 5 - Z	D31	G ■ ■ H ■ ■	43.8/96.6
C302	100	1FK7101-5AF71-1	■ ■ 5 - Z	D32	G ■ ■ H ■ ■	43.8/96.6
C402	100	1FK7101-5AF71-1	■ ■ 5 - Z	D43	G ■ ■ H ■ ■	43.8/96.6
C302	100	1FK7101-5AF71-1	■ ■ 5 - Z	D33	G ■ ■ H ■ ■	54/119.1
C502	100	1FK7101-5AF71-1	■ ■ 5 - Z	D54	G ■ ■ H ■ ■	65.6/144.7
C402	100	1FK7101-5AF71-1	■ ■ 5 - Z	D44	G ■ ■ H ■ ■	54/119.1
C502	100	1FK7101-5AF71-1	■ ■ 5 - Z	D55	G ■ ■ H ■ ■	65.6/144.7
C612	100	1FK7101-5AF71-1	■ ■ 5 - Z	D65	G ■ ■ H ■ ■	80.9/178.4
C712	100	1FK7101-5AF71-1	■ ■ 5 - Z	D76	G ■ ■ H ■ ■	116.2/256.2
C612	100	1FK7101-5AF71-1	■ ■ 5 - Z	D67	G ■ ■ H ■ ■	80.9/178.4
C712	100	1FK7101-5AF71-1	■ ■ 5 - Z	D77	G ■ ■ H ■ ■	116.2/256.2
C812	100	1FK7101-5AF71-1	■ ■ 5 - Z	D88	G ■ ■ H ■ ■	175.8/387.6
Encoder systems: Motors without DRIVE-CLiQ interface	Incremental encoder sin/cos 1 V _{pp} Absolute encoder EnDat 2048 pulses/rev. (shaft height 48 and higher) Absolute encoder EnDat 512 pulses/rev. (only shaft height 36) Basic abs. encoder EnDat 32 pulses/rev. (shaft height 48 and higher) Res., multi-pole (pole no. = pole no. motor) Resolver, 2-pole	A E H G S T				
Encoder systems: Motors with DRIVE-CLiQ interface	Incremental encoder sin/cos 1 V _{pp} Absolute encoder EnDat 2048 pulses/rev. (shaft height 48 and higher) Absolute encoder EnDat 512 pulses/rev. (only shaft height 36) Basic abs. encoder EnDat 32 pulses/rev. (shaft height 48 and higher) Res., multi-pole (pole no. = pole no. motor) Resolver, 2-pole	D F L K U P				
Holding brake:	Motor without holding brake Motor with holding brake	U V				
Order codes for type, type of construction and mounting position, refer to page 3/86						

Selection and ordering data for helical gear motors

Output (S3 -60%)	Output speed	Rated output torque	Max. permissible acceleration torque	Nominal ratio	Exact ratio	Cantilever force gearbox shaft extension	Overload factor
P_2 kW/HP	n_2 rpm	M_2 Nm/lb _f -ft	M_{2max} Nm/lb _f -ft	i_{nom}	i_{exact}	F_{rperm} N/lb _f	f_B
5.19/6.96	644	77/56.7	251/185	3.9	190/49	1671/375.66	1.9
5.18/6.95	423	117/86.2	288/212.3	5.9	2584/441	1917/430.96	2.0
5.19/6.96	424	117/86.2	420/309.5	5.9	377/64	3297/741.20	1.4
5.18/6.95	269	184/135.6	350/258	9.3	3575/384	2237/502.90	2.5
5.20/6.97	241	206/151.8	920/678	10.5	841/81	4886/1098.42	1.1
5.21/6.99	159	313/230.7	600/442.2	16	63/4	4576/1028.73	1.1
5.19/6.96	154	322/237.3	1650/1216.1	16	1037/64	7620/1713.05	2.9
5.20/6.97	107	464/342	850/626.5	23	1495/64	6402/1439.23	1.9
5.19/6.96	100	496/365.6	1650/1216.1	25	5185/208	8797/1977.65	1.1
5.23/7.01	72	694/511.5	1380/1017.1	35	1360/39	9838/2211.68	3.4
	71	703/518.1	4140/3051.2	35	106/3	18528/4165.28	1.1
5.17/6.93	53	931/686.1	2300/1695.1	47	515/11	14923/3354.84	2.2
5.18/6.95	46	1076/793	4140/3051.2	54	704/13	21362/4802.39	1.2
5.16/6.92	36	1370/1009.7	4140/3051.2	69	620/9	23146/5203.45	1.1
7.92/10.62	770	98.2/72.4	366/269.7	4.7	841/216	2872/645.65	2.0
7.93/10.63	774	97.8/72.1	251/185	3.9	190/49	1671/375.66	1.4
7.95/10.66	513	148/109.1	650/479.1	5.9	117/20	4036/907.33	2.4
7.93/10.63	512	148/109.1	288/212.3	5.9	2584/441	1917/430.96	1.1
7.94/10.65	324	234/172.5	850/626.5	9.3	3445/372	4703/1057.28	2.0
	324	234/172.5	550/405.4	9.3	3445/372	3834/861.92	1.3
7.92/10.62	191	396/291.9	920/678	16	377/24	5609/1260.96	1.3
	185	409/301.4	1650/1216.1	16	1037/64	7620/1713.05	2.2
7.90/10.59	129	585/431.1	2300/1695.1	23	255/11	11806/2654.11	2.1
	120	629/463.6	1650/1216.1	25	5185/208	8797/1977.65	1.4
7.93/10.63	85	891/656.7	4140/3051.2	36	106/3	18528/4165.28	2.5
7.96/10.67	86	884/651.5	2300/1695.1	35	2700/77	13552/3046.63	1.4
7.93/10.63	66	1148/846.1	4140/3051.2	46	592/13	20163/4532.84	2.0
7.91/10.61	64	1181/870.4	2300/1695.1	47	515/11	14923/3354.84	1.1
8.00/10.73	44	1737/1280.2	4140/3051.2	69	620/9	23146/5203.45	1.3

Selection and ordering data for helical gear motors

Gearbox size	Motor frame size	Helical geared motors Order No.	Order codes			Total weight, approx. kg/lb
			Gearbox type	Type	Type of construction mounting position	
	SH					
C302	100	1FK7103-5AF71-1 ■■■ 5 - Z	D31	G ■■	H ■■	50.4/111.1
C302	100	1FK7103-5AF71-1 ■■ 5 - Z	D32	G ■■	H ■■	50.4/111.1
C402	100	1FK7103-5AF71-1 ■■ 5 - Z	D42	G ■■	H ■■	60.6/133.6
C302	100	1FK7103-5AF71-1 ■■ 5 - Z	D33	G ■■	H ■■	50.4/111.1
C502	100	1FK7103-5AF71-1 ■■ 5 - Z	D53	G ■■	H ■■	72.2/159.2
C402	100	1FK7103-5AF71-1 ■■ 5 - Z	D44	G ■■	H ■■	60.6/133.6
C612	100	1FK7103-5AF71-1 ■■ 5 - Z	D64	G ■■	H ■■	87.5/192.9
C502	100	1FK7103-5AF71-1 ■■ 5 - Z	D55	G ■■	H ■■	72.2/159.2
C612	100	1FK7103-5AF71-1 ■■ 5 - Z	D65	G ■■	H ■■	87.5/192.9
C612	100	1FK7103-5AF71-1 ■■ 5 - Z	D66	G ■■	H ■■	87.5/192.9
C812	100	1FK7103-5AF71-1 ■■ 5 - Z	D86	G ■■	H ■■	182.4/402.2
C712	100	1FK7103-5AF71-1 ■■ 5 - Z	D77	G ■■	H ■■	122.8/270.8
C812	100	1FK7103-5AF71-1 ■■ 5 - Z	D87	G ■■	H ■■	182.4/402.2
C812	100	1FK7103-5AF71-1 ■■ 5 - Z	D88	G ■■	H ■■	182.4/402.2
C402	100	1FK7105-5AF71-1 ■■ 5 - Z	D41	G ■■	H ■■	70.6/155.7
C302	100	1FK7105-5AF71-1 ■■ 5 - Z	D31	G ■■	H ■■	60.4/133.2
C502	100	1FK7105-5AF71-1 ■■ 5 - Z	D52	G ■■	H ■■	82.2/181.3
C302	100	1FK7105-5AF71-1 ■■ 5 - Z	D32	G ■■	H ■■	60.4/133.2
C502	100	1FK7105-5AF71-1 ■■ 5 - Z	D53	G ■■	H ■■	82.2/181.3
C402	100	1FK7105-5AF71-1 ■■ 5 - Z	D43	G ■■	H ■■	70.6/155.7
C502	100	1FK7105-5AF71-1 ■■ 5 - Z	D54	G ■■	H ■■	82.2/181.3
C612	100	1FK7105-5AF71-1 ■■ 5 - Z	D64	G ■■	H ■■	97.5/215.0
C712	100	1FK7105-5AF71-1 ■■ 5 - Z	D75	G ■■	H ■■	132.8/292.8
C612	100	1FK7105-5AF71-1 ■■ 5 - Z	D65	G ■■	H ■■	97.5/215.0
C812	100	1FK7105-5AF71-1 ■■ 5 - Z	D86	G ■■	H ■■	192.4/424.2
C712	100	1FK7105-5AF71-1 ■■ 5 - Z	D76	G ■■	H ■■	132.8/292.8
C812	100	1FK7105-5AF71-1 ■■ 5 - Z	D87	G ■■	H ■■	192.4/424.2
C712	100	1FK7105-5AF71-1 ■■ 5 - Z	D77	G ■■	H ■■	132.8/292.8
C812	100	1FK7105-5AF71-1 ■■ 5 - Z	D88	G ■■	H ■■	192.4/424.2
Encoder systems: Motors without DRIVE-CLiQ interface	Incremental encoder sin/cos 1 V _{pp} Absolute encoder EnDat 2048 pulses/rev. (shaft height 48 and higher) Absolute encoder EnDat 512 pulses/rev. (only shaft height 36) Basic abs. encoder EnDat 32 pulses/rev. (shaft height 48 and higher) Resolver, multi-pole (pole number = pole number for motor) Resolver, 2-pole	A E H G S T				
Encoder systems: Motors with DRIVE-CLiQ interface	Incremental encoder sin/cos 1 V _{pp} Absolute encoder EnDat 2048 pulses/rev. (shaft height 48 and higher) Absolute encoder EnDat 512 pulses/rev. (only shaft height 36) Basic abs. encoder EnDat 32 pulses/rev. (shaft height 48 and higher) Resolver, multi-pole (pole number = pole number for motor) Resolver, 2-pole	D F L K U P				
Holding brake:	Motor without holding brake Motor with holding brake	U V				
Order codes for type, type of construction and mounting position, refer to page 3/86				.	.	.

9.3 Motors with helical and bevel gearboxes

Selection and ordering data for flat gear motors

Output (S3 -60%) P_2 kW/HP	Output speed n_2 rpm	Rated output torque M_2 Nm/lb _f -ft	Max. permissible acceleration torque M_{2max} Nm/lb _f -ft	Nominal ratio i_{nom}	Exact ratio i_{exact}	Cantilever force gearbox shaft extension $F_{rpermiss}$ N/lb _f	Overload factor f_B
0.30/0.40	696	4.07/3	24/17.7	4.3	56/13	1021/229.53	4.7
	464	6.11/4.5	33/24.3	6.5	84/13	1169/262.80	4.5
	275	10.3/7.6	52/38.3	11	273/25	1392/312.94	4.1
	221	12.9/9.5	62/45.7	13.5	231/17	1497/336.54	3.9
0.41/0.55	130	21.8/16.1	114/84	23	3185/138	1786/401.51	4.2
	86	33.1/24.4	120/88.4	35	3575/102	2053/461.53	2.9
	696	5.64/4.2	45/33.2	4.3	56/13	1021/229.53	6.7
	464	8.46/6.2	64/47.2	6.5	84/13	1169/262.80	6.3
0.79/1.06	275	14.3/10.5	99/73	11	273/25	1392/312.94	5.8
	221	17.8/13.1	105/77.4	13.5	231/17	1497/336.54	5.0
	130	30.2/22.3	120/88.4	23	3185/138	1786/401.51	3.4
	86	45.9/33.8	120/88.4	35	3575/102	2053/461.53	2.2
1.43/1.92	696	10.9/8	45/33.2	4.3	56/13	1021/229.53	3.6
	464	16.3/12	64/47.2	6.5	84/13	1169/262.80	3.4
	275	27.5/20.3	99/73	11	273/25	1392/312.94	3.1
	221	34.3/25.3	105/77.4	13.5	231/17	1497/336.54	2.7
	130	58.2/42.9	120/88.4	23	3185/138	1786/401.51	1.8
	128	59.1/43.6	233/171.7	23	2320/99	2308/468.28	3.4
	86	88.4/65.2	120/88.4	35	3575/102	2053/461.53	1.2
	85	89.4/65.9	270/199	35	390/11	2650/595.75	2.6
2.22/2.98	696	19.6/14.4	80/59	4.3	56/13	1021/229.53	3.2
	464	29.5/21.7	91/67.1	6.5	84/13	1169/262.80	2.4
	275	49.8/36.7	105/77.4	11	273/25	1392/312.94	1.7
	278	49.3/36.3	196/144.5	11	7303/676	1783/400.84	3.1
	221	61.9/45.6	105/77.4	13.5	231/17	1497/336.54	1.3
	220	62.1/45.8	210/154.8	13.5	109/8	1927/433.21	2.6
	128	107/78.9	270/199	23	2320/99	2308/518.86	2.0
	85	162/119.4	270/199	35	390/11	2650/595.75	1.3
2.22/2.98	86	160/117.9	450/331.7	35	7252/207	3666/824.15	2.2
	696	30.5/22.5	80/59	4.3	56/13	1021/229.53	1.7
	464	45.8/33.8	91/67.1	6.5	84/13	1169/262.80	1.3
	540	39.3/29	112/82.5	5.6	5341/962	1428/321.03	1.9
	278	76.5/56.4	196/144.5	11	7303/676	1783/400.84	1.7
	220	96.5/71.1	210/154.8	13.5	109/8	1927/433.21	1.4
2.22/2.98	128	166/122.3	270/199	23	2320/99	2308/518.86	1.1
	86	248/182.8	450/331.7	35	7252/207	3666/824.15	1.2

Selection and ordering data for flat gear motors

Gearbox size	Motor frame size	Offset shaft geared motors Order No.	Order codes Gearbox type	Type	Type of construction mounting position	Total weight, approx.	
						SH	kg/lb
F102	36	1FK7032-5AK71-1	■ ■ 5 - Z	C11	G ■ ■	H ■ ■	13.8/30.4
F102	36	1FK7032-5AK71-1	■ ■ 5 - Z	C12	G ■ ■	H ■ ■	13.8/30.4
F102	36	1FK7032-5AK71-1	■ ■ 5 - Z	C13	G ■ ■	H ■ ■	13.8/30.4
F102	36	1FK7032-5AK71-1	■ ■ 5 - Z	C14	G ■ ■	H ■ ■	13.8/30.4
F102	36	1FK7032-5AK71-1	■ ■ 5 - Z	C15	G ■ ■	H ■ ■	13.8/30.4
F102	36	1FK7032-5AK71-1	■ ■ 5 - Z	C16	G ■ ■	H ■ ■	13.8/30.4
F102	48	1FK7040-5AK71-1	■ ■ 5 - Z	C11	G ■ ■	H ■ ■	14.6/32.2
F102	48	1FK7040-5AK71-1	■ ■ 5 - Z	C12	G ■ ■	H ■ ■	14.6/32.2
F102	48	1FK7040-5AK71-1	■ ■ 5 - Z	C13	G ■ ■	H ■ ■	14.6/32.2
F102	48	1FK7040-5AK71-1	■ ■ 5 - Z	C14	G ■ ■	H ■ ■	14.6/32.2
F102	48	1FK7040-5AK71-1	■ ■ 5 - Z	C15	G ■ ■	H ■ ■	14.6/32.2
F102	48	1FK7040-5AK71-1	■ ■ 5 - Z	C16	G ■ ■	H ■ ■	14.6/32.2
F102	48	1FK7042-5AF71-1	■ ■ 5 - Z	C11	G ■ ■	H ■ ■	15.9/35.1
F102	48	1FK7042-5AF71-1	■ ■ 5 - Z	C12	G ■ ■	H ■ ■	15.9/35.1
F102	48	1FK7042-5AF71-1	■ ■ 5 - Z	C13	G ■ ■	H ■ ■	15.9/35.1
F102	48	1FK7042-5AF71-1	■ ■ 5 - Z	C14	G ■ ■	H ■ ■	15.9/35.1
F102	48	1FK7042-5AF71-1	■ ■ 5 - Z	C15	G ■ ■	H ■ ■	15.9/35.1
F202	48	1FK7042-5AF71-1	■ ■ 5 - Z	C25	G ■ ■	H ■ ■	24.1/53.1
F102	48	1FK7042-5AF71-1	■ ■ 5 - Z	C16	G ■ ■	H ■ ■	15.9/35.1
F202	48	1FK7042-5AF71-1	■ ■ 5 - Z	C26	G ■ ■	H ■ ■	24.1/53.1
F102	63	1FK7060-5AF71-1	■ ■ 5 - Z	C11	G ■ ■	H ■ ■	18.6/41.0
F102	63	1FK7060-5AF71-1	■ ■ 5 - Z	C12	G ■ ■	H ■ ■	18.6/41.0
F102	63	1FK7060-5AF71-1	■ ■ 5 - Z	C13	G ■ ■	H ■ ■	18.6/41.0
F202	63	1FK7060-5AF71-1	■ ■ 5 - Z	C23	G ■ ■	H ■ ■	26.8/59.1
F102	63	1FK7060-5AF71-1	■ ■ 5 - Z	C14	G ■ ■	H ■ ■	18.6/41.0
F202	63	1FK7060-5AF71-1	■ ■ 5 - Z	C24	G ■ ■	H ■ ■	26.8/59.1
F202	63	1FK7060-5AF71-1	■ ■ 5 - Z	C25	G ■ ■	H ■ ■	26.8/59.1
F202	63	1FK7060-5AF71-1	■ ■ 5 - Z	C26	G ■ ■	H ■ ■	26.8/59.1
F302	63	1FK7060-5AF71-1	■ ■ 5 - Z	C36	G ■ ■	H ■ ■	34.4/75.9
F102	63	1FK7063-5AF71-1	■ ■ 5 - Z	C11	G ■ ■	H ■ ■	22.3/49.2
F102	63	1FK7063-5AF71-1	■ ■ 5 - Z	C12	G ■ ■	H ■ ■	22.3/49.2
F202	63	1FK7063-5AF71-1	■ ■ 5 - Z	C22	G ■ ■	H ■ ■	30.5/67.3
F202	63	1FK7063-5AF71-1	■ ■ 5 - Z	C23	G ■ ■	H ■ ■	30.5/67.3
F202	63	1FK7063-5AF71-1	■ ■ 5 - Z	C24	G ■ ■	H ■ ■	30.5/67.3
F202	63	1FK7063-5AF71-1	■ ■ 5 - Z	C25	G ■ ■	H ■ ■	30.5/67.3
F302	63	1FK7063-5AF71-1	■ ■ 5 - Z	C36	G ■ ■	H ■ ■	38.1/84.0
Encoder systems: Motors without DRIVE-CLiQ interface	Incremental encoder sin/cos 1 V _{pp} Absolute encoder EnDat 2048 pulses/rev. (shaft height 48 and higher) Absolute encoder EnDat 512 pulses/rev. (only shaft height 36) Basic abs. encoder EnDat 32 pulses/rev. (shaft height 48 and higher) Res., multi-pole (pole no. = pole no. motor) Resolver, 2-pole	A E H G S T					
Encoder systems: Motors with DRIVE-CLiQ interface	Incremental encoder sin/cos 1 V _{pp} Absolute encoder EnDat 2048 pulses/rev. (shaft height 48 and higher) Absolute encoder EnDat 512 pulses/rev. (only shaft height 36) Basic abs. encoder EnDat 32 pulses/rev. (shaft height 48 and higher) Res., multi-pole (pole no. = pole no. motor) Resolver, 2-pole	D F L K U P					
Holding brake:	Motor without holding brake Motor with holding brake	U V					
Order codes for type, type of construction and mounting position, refer to page 3/86							

Selection and ordering data for flat gear motors

Output (S3 -60%) P_2 kW/HP	Output speed n_2 rpm	Rated output torque M_2 Nm/lb _f -ft	Max. permissible acceleration torque M_{2max} Nm/lb _f -ft	Nominal ratio i_{nom}	Exact ratio i_{exact}	Cantilever force gearbox shaft extension $F_{Tpermiss}$ N/lb _f	Overload factor f_B
2.08/2.79	540	36.6/27	173/127.5	5.6	5341/962	1428/321.03	4.0
	278	71.3/52.5	210/154.8	11	7303/676	1783/400.84	2.5
	220	89.9/66.3	210/154.8	13.5	109/8	1927/433.21	2.0
	128	155/114.2	270/199	23	2320/99	2308/518.86	1.5
3.20/4.29	128	155/114.2	450/331.7	24	588/25	3210/721.64	2.5
	86	231/170.2	450/331.7	35	7252/207	3666/824.15	1.7
	86	231/170.2	700/515.9	35	2210/63	4523/1016.82	2.6
	540	56.5/41.6	173/127.5	5.6	5341/962	1428/321.03	2.0
3.20/4.29	278	110/81.1	210/154.8	11	7303/676	1783/400.84	1.3
	224	136/100.2	350/258	13.5	7696/575	2660/597.99	1.7
	221	138/101.7	550/405.4	13.5	5984/441	3296/740.97	2.6
	128	240/176.9	450/331.7	24	588/25	3210/721.64	1.2
3.66/4.91	129	236/173.9	700/515.9	23	325/14	3942/886.20	1.9
	86	357/263.1	700/515.9	35	2210/63	4523/1016.82	1.3
	85	359/264.6	1100/810.7	35	845/24	6120/1375.84	2.0
	516	67.7/49.9	482/355.2	5.8	3784/651	2484/558.43	4.8
3.66/4.91	277	126/92.9	550/405.4	11	682/63	3057/687.24	2.9
	221	158/116.4	550/405.4	13.5	5984/441	3296/740.97	2.3
	129	270/199	700/515.9	23	325/14	3942/886.20	1.7
	129	271/199.7	1100/810.7	23	1885/81	5331/1198.46	2.7
4.72/6.33	86	408/300.7	700/515.9	35	2210/63	4523/1016.82	1.1
	516	87.4/64.4	482/355.2	5.8	3784/651	2484/558.43	3.2
	277	163/120.1	550/405.4	11	682/63	3057/687.24	1.9
	221	204/150.3	550/405.4	13.5	5984/441	3296/740.97	1.5
5.20/6.97	220	205/151.1	1000/737	13.5	871/64	4458/1002.20	2.8
	129	349/257.2	700/515.9	23	325/14	3942/886.20	1.2
	85	529/389.9	1100/810.7	35	845/24	6120/1375.84	1.2
	430	115/84.8	482/355.2	5.8	3784/651	2484/558.43	2.4
5.20/6.97	231	215/158.5	550/405.4	11	682/63	3057/687.24	1.5
	184	269/198.3	991/730.4	13.5	2077/192	4130/928.47	2.6
	183	270/199	550/405.4	13.5	5984/441	3296/740.97	1.2
	108	460/339	1000/737	23	871/64	4458/1002.20	2.1
7.93/10.63	108	460/339	1100/810.7	23	1885/81	5331/1198.46	1.4
	529	143/105.4	766/564.5	5.7	1407/248	3330/748.62	2.9
	516	147/108.3	482/355.2	6	3784/651	2484/558.43	1.8
	277	273/201.2	991/730.4	11	2077/192	4130/928.47	2.0
7.93/10.63	277	273/201.2	550/405.4	11	682/63	3057/687.24	1.1
	220	343/252.8	1000/737	13.6	871/64	4458/1002.20	1.6
	129	587/432.6	1100/810.7	24	1885/81	5331/1198.46	1.0

Selection and ordering data for flat gear motors

Gearbox size	Motor frame size	Offset shaft geared motors	Order codes			Total weight, approx.	
			Order No.	Gearbox type	Type		Type of construction mounting position
		SH				kg/lb	
F202	80	1FK7080-5AF71-1	■ ■ 5 - Z	C22	G ■ ■	H ■ ■	30.2/66.6
F202	80	1FK7080-5AF71-1	■ ■ 5 - Z	C23	G ■ ■	H ■ ■	30.2/66.6
F202	80	1FK7080-5AF71-1	■ ■ 5 - Z	C24	G ■ ■	H ■ ■	30.2/66.6
F202	80	1FK7080-5AF71-1	■ ■ 5 - Z	C25	G ■ ■	H ■ ■	30.2/66.6
F302	80	1FK7080-5AF71-1	■ ■ 5 - Z	C35	G ■ ■	H ■ ■	37.8/83.4
F302	80	1FK7080-5AF71-1	■ ■ 5 - Z	C36	G ■ ■	H ■ ■	37.8/83.4
F402	80	1FK7080-5AF71-1	■ ■ 5 - Z	C46	G ■ ■	H ■ ■	46.1/101.7
F202	80	1FK7083-5AF71-1	■ ■ 5 - Z	C22	G ■ ■	H ■ ■	35.4/78.1
F202	80	1FK7083-5AF71-1	■ ■ 5 - Z	C23	G ■ ■	H ■ ■	35.4/78.1
F302	80	1FK7083-5AF71-1	■ ■ 5 - Z	C33	G ■ ■	H ■ ■	43/94.8
F302	80	1FK7083-5AF71-1	■ ■ 5 - Z	C34	G ■ ■	H ■ ■	43/94.8
F402	80	1FK7083-5AF71-1	■ ■ 5 - Z	C44	G ■ ■	H ■ ■	51.3/113.1
F302	80	1FK7083-5AF71-1	■ ■ 5 - Z	C35	G ■ ■	H ■ ■	43/94.8
F402	80	1FK7083-5AF71-1	■ ■ 5 - Z	C45	G ■ ■	H ■ ■	51.3/113.1
F402	80	1FK7083-5AF71-1	■ ■ 5 - Z	C46	G ■ ■	H ■ ■	51.3/113.1
F602	80	1FK7083-5AF71-1	■ ■ 5 - Z	C66	G ■ ■	H ■ ■	78.3/172.7
F402	100	1FK7100-5AF71-1	■ ■ 5 - Z	C42	G ■ ■	H ■ ■	53.5/118.0
F402	100	1FK7100-5AF71-1	■ ■ 5 - Z	C43	G ■ ■	H ■ ■	53.3/118.0
F402	100	1FK7100-5AF71-1	■ ■ 5 - Z	C44	G ■ ■	H ■ ■	53.5/118.0
F402	100	1FK7100-5AF71-1	■ ■ 5 - Z	C45	G ■ ■	H ■ ■	53.3/118.0
F602	100	1FK7100-5AF71-1	■ ■ 5 - Z	C65	G ■ ■	H ■ ■	80.5/178.0
F402	100	1FK7100-5AF71-1	■ ■ 5 - Z	C46	G ■ ■	H ■ ■	53.3/118.0
F402	100	1FK7101-5AF71-1	■ ■ 5 - Z	C42	G ■ ■	H ■ ■	59.1/130.3
F402	100	1FK7101-5AF71-1	■ ■ 5 - Z	C43	G ■ ■	H ■ ■	59.1/130.3
F402	100	1FK7101-5AF71-1	■ ■ 5 - Z	C44	G ■ ■	H ■ ■	59.1/130.3
F602	100	1FK7101-5AF71-1	■ ■ 5 - Z	C64	G ■ ■	H ■ ■	86.1/189.9
F402	100	1FK7101-5AF71-1	■ ■ 5 - Z	C45	G ■ ■	H ■ ■	59.1/130.3
F602	100	1FK7101-5AF71-1	■ ■ 5 - Z	C66	G ■ ■	H ■ ■	86.1/189.9
F402	100	1FK7103-5AF71-1	■ ■ 5 - Z	C42	G ■ ■	H ■ ■	65.7/144.9
F402	100	1FK7103-5AF71-1	■ ■ 5 - Z	C43	G ■ ■	H ■ ■	65.7/144.9
F602	100	1FK7103-5AF71-1	■ ■ 5 - Z	C63	G ■ ■	H ■ ■	92.7/102.4
F402	100	1FK7103-5AF71-1	■ ■ 5 - Z	C44	G ■ ■	H ■ ■	65.7/144.9
F602	100	1FK7103-5AF71-1	■ ■ 5 - Z	C64	G ■ ■	H ■ ■	92.7/102.4
F602	100	1FK7103-5AF71-1	■ ■ 5 - Z	C65	G ■ ■	H ■ ■	92.7/102.4
F602	100	1FK7105-5AF71-1	■ ■ 5 - Z	C62	G ■ ■	H ■ ■	103/227.1
F402	100	1FK7105-5AF71-1	■ ■ 5 - Z	C42	G ■ ■	H ■ ■	75.7/166.9
F602	100	1FK7105-5AF71-1	■ ■ 5 - Z	C63	G ■ ■	H ■ ■	103/227.1
F402	100	1FK7105-5AF71-1	■ ■ 5 - Z	C43	G ■ ■	H ■ ■	75.7/166.9
F602	100	1FK7105-5AF71-1	■ ■ 5 - Z	C64	G ■ ■	H ■ ■	103/227.1
F602	100	1FK7105-5AF71-1	■ ■ 5 - Z	C65	G ■ ■	H ■ ■	103/227.1
Encoder systems:	Incremental encoder sin/cos 1 V _{pp}	A					
	Absolute encoder EnDat 2048 pulses/rev.	E					
Motors without DRIVE-CLiQ interface	(shaft height 48 and higher)						
	Absolute encoder EnDat 512 pulses/rev.	H					
	(only shaft height 36)						
	Basic abs. encoder EnDat 32 pulses/rev.	G					
	(shaft height 48 and higher)						
	Res., multi-pole (pole no. = pole no. motor)	S					
	Resolver, 2-pole	T					
Encoder systems:	Incremental encoder sin/cos 1 V _{pp}	D					
	Absolute encoder EnDat 2048 pulses/rev.	F					
Motors with DRIVE-CLiQ interface	(shaft height 48 and higher)						
	Absolute encoder EnDat 512 pulses/rev.	L					
	(only shaft height 36)						
	Basic abs. encoder EnDat 32 pulses/rev.	K					
	(shaft height 48 and higher)						
	Res., multi-pole (pole no. = pole no. motor)	U					
	Resolver, 2-pole	P					
Holding brake:	Motor without holding brake	U					
	Motor with holding brake	V					
Order codes for type, type of construction and mounting position, refer to page 3/86						.	.

9.3 Motors with helical and bevel gearboxes

Selection and ordering data for bevel gear motors

Output (S3-60%) P_2 kW/HP	Output speed n_2 rpm	Rated output torque M_2 Nm/lb _f -ft	Max. permissible acceleration torque M_{2max} Nm/lb _f -ft	Nominal ratio i_{nom}	Exact ratio i_{exact}	Cantilever force gearbox shaft extension F_{Tperm} N/lb _f	Overload factor f_B
0.30/0.40	750	3.78/2.8	22/16.2	4	4/1	1494/335.87	4.7
	500	5.68/4.2	31/22.8	6	6/1	1710/384.43	4.5
	296	9.59/7.1	48/35.4	10	507/50	2037/457.94	4.1
	179	15.8/11.6	73/53.8	16.5	117/7	2406/540.89	3.8
	129	22/16.2	102/75.2	23	1140/49	2686/603.84	3.8
85	33.2/24.5	135/99.5	35	3686/105	3081/692.64	3.3	
0.41/0.55	750	5.24/3.9	42/31	4	4/1	1494/335.87	6.7
	500	7.86/5.8	59/43.5	6	6/1	1710/384.43	6.3
	296	13.3/9.8	92/67.8	10	507/50	2037/457.94	5.8
	179	21.9/16.1	122/89.9	16.5	117/7	2406/540.89	4.7
	129	30.5/22.5	135/99.5	23	1140/49	2686/603.84	3.7
85	46/33.9	135/99.5	35	3686/105	3081/692.64	2.5	
65	60.5/44.6	220/162.1	46	1849/40	4053/911.15	3.1	
0.79/1.06	750	10.1/7.4	42/31	4	4/1	1494/335.87	3.6
	500	15.1/11.1	59/43.5	6	6/1	1710/384.43	3.4
	296	25.6/18.9	92/67.8	10	507/50	2037/457.94	3.1
	179	42.2/31.1	122/89.9	16.5	117/7	2406/540.89	2.5
	129	58.7/43.3	135/99.5	23	1140/49	2686/603.84	2.0
1.43/1.92	750	18.2/13.4	76/56	4	4/1	1494/335.87	3.3
	500	27.4/20.2	87/64.1	6	6/1	1710/384.43	2.5
	296	46.2/34	103/75.9	10	507/50	2037/457.94	1.8
	178	76.9/56.7	219/161.4	17	2967/176	2895/650.82	2.2
	129	106/78.1	220/162.1	23	2967/128	3220/723.89	1.6
2.22/2.98	750	28.3/20.9	76/56	4	4/1	1494/335.87	1.8
	750	28.3/20.9	83/61.2	4	4/1	1793/403.08	2.0
	500	42.5/31.3	87/64.1	6	6/1	1710/384.43	1.4
	500	42.5/31.3	128/94.3	6	6/1	2394/538.20	2.0
	324	65.6/48.3	186/137.1	9.3	1075/116	2767/622.05	1.9
2.17/2.91	178	119/87.7	219/161.4	17	2967/176	2895/650.82	1.2
	129	165/121.6	385/283.7	23	559/24	3762/845.74	1.5
	86	246/181.3	385/283.7	35	903/26	4298/1062.90	1.0
	65	328/241.7	600/442.2	46	602/13	7570/1701.81	1.2
	46	450/331.7	1000/737	65	12586/195	10154/2282.72	1.5

Selection and ordering data for bevel gear motors

Gearbox size	Motor frame size	Bevel geared motors Order No.	Order codes Gearbox type	Type	Type of construction mounting position	Total weight, approx.	
						SH	kg/lb
K102	36	1FK7032-5AK71-1	■ ■ 5 - Z	B11	G ■ ■	H ■ ■	12.3/27.1
K102	36	1FK7032-5AK71-1	■ ■ 5 - Z	B12	G ■ ■	H ■ ■	12.3/27.1
K102	36	1FK7032-5AK71-1	■ ■ 5 - Z	B13	G ■ ■	H ■ ■	12.3/27.1
K102	36	1FK7032-5AK71-1	■ ■ 5 - Z	B14	G ■ ■	H ■ ■	12.3/27.1
K102	36	1FK7032-5AK71-1	■ ■ 5 - Z	B15	G ■ ■	H ■ ■	12.3/27.1
K102	36	1FK7032-5AK71-1	■ ■ 5 - Z	B16	G ■ ■	H ■ ■	12.3/27.1
K202	36	1FK7032-5AK71-1	■ ■ 5 - Z	B27	G ■ ■	H ■ ■	19.8/43.7
K202	36	1FK7032-5AK71-1	■ ■ 5 - Z	B28	G ■ ■	H ■ ■	19.8/43.7
K102	48	1FK7040-5AK71-1	■ ■ 5 - Z	B11	G ■ ■	H ■ ■	13.1/28.9
K102	48	1FK7040-5AK71-1	■ ■ 5 - Z	B12	G ■ ■	H ■ ■	13.1/28.9
K102	48	1FK7040-5AK71-1	■ ■ 5 - Z	B13	G ■ ■	H ■ ■	13.1/28.9
K102	48	1FK7040-5AK71-1	■ ■ 5 - Z	B14	G ■ ■	H ■ ■	13.1/28.9
K102	48	1FK7040-5AK71-1	■ ■ 5 - Z	B15	G ■ ■	H ■ ■	13.1/28.9
K102	48	1FK7040-5AK71-1	■ ■ 5 - Z	B16	G ■ ■	H ■ ■	13.1/28.9
K202	48	1FK7040-5AK71-1	■ ■ 5 - Z	B27	G ■ ■	H ■ ■	20.6/45.4
K102	48	1FK7042-5AF71-1	■ ■ 5 - Z	B11	G ■ ■	H ■ ■	14.4/31.8
K102	48	1FK7042-5AF71-1	■ ■ 5 - Z	B12	G ■ ■	H ■ ■	14.4/31.8
K102	48	1FK7042-5AF71-1	■ ■ 5 - Z	B13	G ■ ■	H ■ ■	14.4/31.8
K102	48	1FK7042-5AF71-1	■ ■ 5 - Z	B14	G ■ ■	H ■ ■	14.4/31.8
K102	48	1FK7042-5AF71-1	■ ■ 5 - Z	B15	G ■ ■	H ■ ■	14.4/31.8
K102	48	1FK7042-5AF71-1	■ ■ 5 - Z	B16	G ■ ■	H ■ ■	14.4/31.8
K202	48	1FK7042-5AF71-1	■ ■ 5 - Z	B26	G ■ ■	H ■ ■	21.9/48.3
K102	63	1FK7060-5AF71-1	■ ■ 5 - Z	B11	G ■ ■	H ■ ■	17.1/37.7
K102	63	1FK7060-5AF71-1	■ ■ 5 - Z	B12	G ■ ■	H ■ ■	17.1/37.7
K102	63	1FK7060-5AF71-1	■ ■ 5 - Z	B13	G ■ ■	H ■ ■	17.1/37.7
K202	63	1FK7060-5AF71-1	■ ■ 5 - Z	B24	G ■ ■	H ■ ■	24.6/54.2
K202	63	1FK7060-5AF71-1	■ ■ 5 - Z	B25	G ■ ■	H ■ ■	24.6/54.2
K302	63	1FK7060-5AF71-1	■ ■ 5 - Z	B35	G ■ ■	H ■ ■	29.6/65.3
K202	63	1FK7060-5AF71-1	■ ■ 5 - Z	B26	G ■ ■	H ■ ■	24.6/54.2
K302	63	1FK7060-5AF71-1	■ ■ 5 - Z	B36	G ■ ■	H ■ ■	29.6/65.3
K302	63	1FK7060-5AF71-1	■ ■ 5 - Z	B37	G ■ ■	H ■ ■	29.6/65.3
K402	63	1FK7060-5AF71-1	■ ■ 5 - Z	B47	G ■ ■	H ■ ■	43.1/95.0
K513	63	1FK7060-5AF71-1	■ ■ 5 - Z	B58	G ■ ■	H ■ ■	48.9/107.8
K102	63	1FK7063-5AF71-1	■ ■ 5 - Z	B11	G ■ ■	H ■ ■	20.8/45.9
K202	63	1FK7063-5AF71-1	■ ■ 5 - Z	B21	G ■ ■	H ■ ■	28.3/62.4
K102	63	1FK7063-5AF71-1	■ ■ 5 - Z	B12	G ■ ■	H ■ ■	20.8/45.9
K302	63	1FK7063-5AF71-1	■ ■ 5 - Z	B32	G ■ ■	H ■ ■	33.3/73.4
K302	63	1FK7063-5AF71-1	■ ■ 5 - Z	B33	G ■ ■	H ■ ■	33.3/73.4
K202	63	1FK7063-5AF71-1	■ ■ 5 - Z	B24	G ■ ■	H ■ ■	28.3/62.4
K302	63	1FK7063-5AF71-1	■ ■ 5 - Z	B35	G ■ ■	H ■ ■	33.3/73.4
K302	63	1FK7063-5AF71-1	■ ■ 5 - Z	B36	G ■ ■	H ■ ■	33.3/73.4
K402	63	1FK7063-5AF71-1	■ ■ 5 - Z	B47	G ■ ■	H ■ ■	46.8/103.2
K513	63	1FK7063-5AF71-1	■ ■ 5 - Z	B58	G ■ ■	H ■ ■	52.6/116.0
Encoder systems: Motors without DRIVE-CLiQ interface	Incremental encoder sin/cos 1 V _{pp} Absolute encoder EnDat 2048 pulses/rev. (shaft height 48 and higher) Absolute encoder EnDat 512 pulses/rev. (only shaft height 36) Basic abs. encoder EnDat 32 pulses/rev. (shaft height 48 and higher) Res., multi-pole (pole no. = pole no. motor) Resolver, 2-pole	A E H G S T					
Encoder systems: Motors with DRIVE-CLiQ interface	Incremental encoder sin/cos 1 V _{pp} Absolute encoder EnDat 2048 pulses/rev. (shaft height 48 and higher) Absolute encoder EnDat 512 pulses/rev. (only shaft height 36) Basic abs. encoder EnDat 32 pulses/rev. (shaft height 48 and higher) Res., multi-pole (pole no. = pole no. motor) Resolver, 2-pole	D F L K U P					
Holding brake:	Motor without holding brake Motor with holding brake	U V					
Order codes for type, type of construction and mounting position, refer to page 3/86						.	.

Selection and ordering data for bevel gear motors

Output (S3-60%)	Output speed	Rated output torque	Max. permissible acceleration torque	Nominal ratio	Exact ratio	Cantilever force gearbox shaft extension	Overload factor
P_2 kW/HP	n_2 rpm	M_2 Nm/lb _f -ft	M_{2max} Nm/lb _f -ft	i_{nom}	i_{exact}	F_{rperm} N/lb _f	f_B
2.07/2.78	750	26.4/19.5	135/99.5	4	4/1	1793/403.08	4.4
	500	39.6/29.2	155/114.2	6	6/1	2052/461.31	3.3
	298	66.4/48.9	184/135.6	10	2881/286	2439/548.31	2.4
	177	112/82.5	384/283	17	559/33	3383/760.53	2.9
	129	153/112.8	220/162.1	23	2967/128	3220/723.89	1.2
2.03/2.72	129	154/113.5	385/283.7	23	559/24	3762/845.74	2.1
	86	229/168.8	600/442.2	35	4171/120	6879/1546.47	2.2
	62	313/230.7	1000/737	48	2697/56	9210/2070.50	2.7
3.20/4.29	39	495/364.8	1600/1179.2	76	126697/1664	12763/2869.25	2.7
	750	40.7/30	135/99.5	4	4/1	1793/403.08	2.2
3.14/4.21	500	61.1/45	155/114.2	6	6/1	2052/461.31	1.7
	298	103/75.9	184/135.6	10	2881/286	2394/538.20	2.9
	324	94.4/69.6	314/231.4	9.3	1075/116	2767/622.05	2.2
	177	173/127.5	384/283	17	559/33	3383/760.53	1.5
	129	237/174.7	575/423.8	17	559/33	5414/1217.12	2.2
	93	324/238.8	385/283.7	23	559/24	3762/845.74	1.1
	62	483/356	1000/737	48	2697/56	9210/2070.50	1.4
3.19/4.28	63	479/353	1600/1179.2	48	3971/1832	10923/2455.60	2.2
	46	648/477.6	1000/737	65	12586/195	10154/2282.72	1.0
3.66/4.91	46	651/479.8	2574/1877.1	65	33201/512	16635/3739.71	2.6
	86	354/260.9	600/442.2	35	4171/120	6879/1546.47	1.1
	750	46.6/34.3	356/262.4	4	4/1	3346/752.21	5.1
	500	69.8/51.4	407/300	6	6/1	3830/861.02	3.9
3.60/4.83	297	118/87	484/356.7	10	1333/132	4556/1024.23	2.7
	177	197/145.2	575/423.8	17	559/33	5414/1217.12	1.9
	129	271/199.7	600/442.2	23	559/24	6020/1353.36	1.5
3.60/4.83	123	279/205.6	1000/737	24	11687/480	7337/1649.43	2.4
	93	371/273.4	1000/737	32	20677/640	8062/1812.42	1.8
	87	397/292.6	1600/1179.2	35	35441/1024	9813/2206.06	2.7
	60	572/421.6	2600/1916.2	50	166005/3328	15242/3426.55	3.0
	46	744/548.3	2600/1916.2	65	33201/512	16635/3739.71	2.3

Selection and ordering data for bevel gear motors

Gearbox size	Motor frame size	Bevel geared motors Order No.	Order codes Gearbox type	Type	Type of construction mounting position	Total weight, approx.	
						kg/lb	
K202	80	1FK7080-5AF71-1	■ ■ 5 - Z	B21	G ■ ■	H ■ ■	28/61.7
	80	1FK7080-5AF71-1	■ ■ 5 - Z	B22	G ■ ■	H ■ ■	28/61.7
K302	80	1FK7080-5AF71-1	■ ■ 5 - Z	B23	G ■ ■	H ■ ■	28/61.7
	80	1FK7080-5AF71-1	■ ■ 5 - Z	B34	G ■ ■	H ■ ■	33/72.8
K402	80	1FK7080-5AF71-1	■ ■ 5 - Z	B25	G ■ ■	H ■ ■	28/61.7
	80	1FK7080-5AF71-1	■ ■ 5 - Z	B35	G ■ ■	H ■ ■	33/72.8
	80	1FK7080-5AF71-1	■ ■ 5 - Z	B46	G ■ ■	H ■ ■	46.5/102.5
K513	80	1FK7080-5AF71-1	■ ■ 5 - Z	B57	G ■ ■	H ■ ■	52.3/115.3
	80	1FK7080-5AF71-1	■ ■ 5 - Z	B68	G ■ ■	H ■ ■	73.8/162.7
K202	80	1FK7083-5AF71-1	■ ■ 5 - Z	B21	G ■ ■	H ■ ■	33.2/73.2
	80	1FK7083-5AF71-1	■ ■ 5 - Z	B22	G ■ ■	H ■ ■	33.2/73.2
K302	80	1FK7083-5AF71-1	■ ■ 5 - Z	B32	G ■ ■	H ■ ■	38.2/84.2
	80	1FK7083-5AF71-1	■ ■ 5 - Z	B23	G ■ ■	H ■ ■	33.2/73.2
K302	80	1FK7083-5AF71-1	■ ■ 5 - Z	B33	G ■ ■	H ■ ■	38.2/84.2
	80	1FK7083-5AF71-1	■ ■ 5 - Z	B34	G ■ ■	H ■ ■	38.2/84.2
K402	80	1FK7083-5AF71-1	■ ■ 5 - Z	B44	G ■ ■	H ■ ■	51.7/114.0
	80	1FK7083-5AF71-1	■ ■ 5 - Z	B35	G ■ ■	H ■ ■	38.2/84.2
K513	80	1FK7083-5AF71-1	■ ■ 5 - Z	B55	G ■ ■	H ■ ■	57.5/126.8
	80	1FK7083-5AF71-1	■ ■ 5 - Z	B56	G ■ ■	H ■ ■	57.5/126.8
K513	80	1FK7083-5AF71-1	■ ■ 5 - Z	B57	G ■ ■	H ■ ■	57.5/126.8
	80	1FK7083-5AF71-1	■ ■ 5 - Z	B67	G ■ ■	H ■ ■	79/174.2
K513	80	1FK7083-5AF71-1	■ ■ 5 - Z	B58	G ■ ■	H ■ ■	57.5/126.8
	80	1FK7083-5AF71-1	■ ■ 5 - Z	B78	G ■ ■	H ■ ■	107.3/236.6
K402	80	1FK7083-5AF71-1	■ ■ 5 - Z	B46	G ■ ■	H ■ ■	51.7/114.0
K402	100	1FK7100-5AF71-1	■ ■ 5 - Z	B41	G ■ ■	H ■ ■	53.9/118.9
	100	1FK7100-5AF71-1	■ ■ 5 - Z	B42	G ■ ■	H ■ ■	53.9/118.9
K402	100	1FK7100-5AF71-1	■ ■ 5 - Z	B43	G ■ ■	H ■ ■	53.9/118.9
	100	1FK7100-5AF71-1	■ ■ 5 - Z	B44	G ■ ■	H ■ ■	53.9/118.9
	100	1FK7100-5AF71-1	■ ■ 5 - Z	B45	G ■ ■	H ■ ■	53.9/118.9
K513	100	1FK7100-5AF71-1	■ ■ 5 - Z	B55	G ■ ■	H ■ ■	59.7/131.6
	100	1FK7100-5AF71-1	■ ■ 5 - Z	B56	G ■ ■	H ■ ■	59.7/131.6
K613	100	1FK7100-5AF71-1	■ ■ 5 - Z	B66	G ■ ■	H ■ ■	81.2/179.1
	100	1FK7100-5AF71-1	■ ■ 5 - Z	B77	G ■ ■	H ■ ■	109.5/241.5
	100	1FK7100-5AF71-1	■ ■ 5 - Z	B78	G ■ ■	H ■ ■	109.5/241.5
Encoder systems: Motors without DRIVE-CLiQ interface	Incremental encoder sin/cos 1 V _{pp} Absolute encoder EnDat 2048 pulses/rev. (shaft height 48 and higher) Absolute encoder EnDat 512 pulses/rev. (only shaft height 36) Basic abs. encoder EnDat 32 pulses/rev. (shaft height 48 and higher) Res., multi-pole (pole no. = pole no. motor) Resolver, 2-pole	A					
		E					
		H					
		G					
		S					
Encoder systems: Motors with DRIVE-CLiQ interface	Incremental encoder sin/cos 1 V _{pp} Absolute encoder EnDat 2048 pulses/rev. (shaft height 48 and higher) Absolute encoder EnDat 512 pulses/rev. (only shaft height 36) Basic abs. encoder EnDat 32 pulses/rev. (shaft height 48 and higher) Res., multi-pole (pole no. = pole no. motor) Resolver, 2-pole	D					
		F					
		L					
		K					
		U					
Holding brake:	Motor without holding brake Motor with holding brake	U					
		V					
Order codes for type, type of construction and mounting position, refer to page 3/86						- .	

Selection and ordering data for bevel gear motors

Output (S3-60%) P_2 kW/HP	Output speed n_2 rpm	Rated output torque M_2 Nm/lb _f -ft	Max. permissible acceleration torque M_{2max} Nm/lb _f -ft	Nominal ratio i_{nom}	Exact ratio i_{exact}	Cantilever force gearbox shaft extension $F_{Tpermiss}$ N/lb _f	Overload factor f_B
4.72/6.33	750	60.1/44.3	356/262.4	4	4/1	3346/752.21	3.4
	500	90.2/66.5	407/300	6			
	297	152/112	484/356.7	10	1333/132	4556/1024.23	1.8
4.66/6.25	186	238/175.4	1000/737	16	2607/1/1620	6391/1436.76	2.4
	123	361/266.1	1000/737	24			
	125	356/262.4	1584/1167.4	24	24583/1024	8687/1952.92	2.6
	87	513/378.1	1600/1179.2	35	35441/1024	9813/2206.06	1.8
	85	525/386.9	2600/1916.2	35	567/16	13600/3057.42	2.8
4.64/6.22	60	739/544.6	2600/1916.2	50	166005/3328	15242/3426.55	2.0
4.63/6.21	46	961/708.3	2600/1916.2	65	33201/512	16635/3739.71	1.6
4.67/6.26	46	969/714.2	4650/3427.1	65	188387/2880	21991/4943.80	2.8
5.17/6.93	625	79/58.2	356/262.4	4	4/1	3346/752.21	2.5
5.20/6.97	417	119/87.7	407/300	6	6/1	3830/861.02	1.9
5.19/6.96	248	200/147.4	484/356.7	10	1333/132	4556/1024.23	1.4
5.13/6.88	246	199/146.7	900/663.3	10	203/20	5481/1232.18	2.6
	155	315/232.2	1000/737	16			
	158	310/228.5	1380/1017.1	16	54839/3456	7567/1701.14	2.5
	103	477/351.5	1000/737	24	11687/480	7337/1649.43	1.2
	104	470/346.4	1584/1167.4	24	24583/1024	8687/1952.92	1.9
72	678/499.7	1600/1179.2	35	35441/1024	9813/2206.06	1.3	
5.16/6.92	71	694/511.5	2600/1916.2	35	567/16	13600/3057.42	2.1
5.12/6.87	50	978/720.8	2600/1916.2	50	166005/3328	15242/3426.55	1.5
5.13/6.88	51	960/707.5	4650/3427.1	49	5487/112	19971/4489.68	2.8
5.19/6.96	39	1271/936.7	2600/1916.2	65	33201/512	16635/3739.71	1.2
5.09/6.83	38	1280/943.4	4650/3427.1	65	188387/2880	21991/4943.80	2.1
7.93/10.63	750	101/74.4	356/262.4	4	4/1	3346/752.21	1.9
	500	151/111.3	407/300	6	6/1	3830/861.02	1.5
7.81/10.47	296	252/185.7	900/663.3	10	203/20	5481/1232.18	1.9
7.93/10.63	297	255/187.9	484/356.7	10	1333/132	4556/1024.23	1.0
7.80/10.46	189	394/290.4	1380/1017.1	16	54839/3456	7567/1701.14	1.9
	186	400/294.8	1000/737	16	2607/1/1620	6391/1436.76	1.4
	125	597/440	1584/1167.4	24	24583/1024	8687/1952.92	1.4
	119	626/461.4	2600/1916.2	25	64449/2560	12135/2728.07	2.3
7.84/10.51	85	881/649.3	2600/1916.2	35	567/16	3276/736.48	1.6
7.80/10.46	83	898/661.8	4255/3135.9	36	2891/80	18045/4056.70	2.6
	61	1218/897.7	4650/3427.1	49	5487/112	19971/4489.68	2.1
	60	1240/913.9	2600/1916.2	50	166005/3328	15242/3426.55	1.1
7.83/10.50	46	1626/1198.4	4650/3427.1	65	188387/2880	21991/4943.80	1.5

Selection and ordering data for bevel gear motors

	Gearbox size	Motor frame size	Bevel geared motors		Order codes			Total weight, approx. kg/lb
			Order No.		Gearbox type	Type	Type of construction mounting position	
	K402	100	1FK7101-5AF71-1	■ ■ 5 - Z	B41	G ■ ■	H ■ ■	59.5/131.2
	K402	100	1FK7101-5AF71-1	■ ■ 5 - Z	B42	G ■ ■	H ■ ■	59.5/131.2
	K402	100	1FK7101-5AF71-1	■ ■ 5 - Z	B43	G ■ ■	H ■ ■	59.5/131.2
	K402	100	1FK7101-5AF71-1	■ ■ 5 - Z	B44	G ■ ■	H ■ ■	59.5/131.2
	K513	100	1FK7101-5AF71-1	■ ■ 5 - Z	B54	G ■ ■	H ■ ■	65.3/144.0
	K513	100	1FK7101-5AF71-1	■ ■ 5 - Z	B55	G ■ ■	H ■ ■	65.3/144.0
	K613	100	1FK7101-5AF71-1	■ ■ 5 - Z	B65	G ■ ■	H ■ ■	86.8/191.4
	K613	100	1FK7101-5AF71-1	■ ■ 5 - Z	B66	G ■ ■	H ■ ■	86.8/191.4
	K713	100	1FK7101-5AF71-1	■ ■ 5 - Z	B76	G ■ ■	H ■ ■	115.1/253.8
	K713	100	1FK7101-5AF71-1	■ ■ 5 - Z	B77	G ■ ■	H ■ ■	115.1/253.8
	K713	100	1FK7101-5AF71-1	■ ■ 5 - Z	B78	G ■ ■	H ■ ■	115.1/253.8
	K813	100	1FK7101-5AF71-1	■ ■ 5 - Z	B88	G ■ ■	H ■ ■	168.5/371.5
	K402	100	1FK7103-5AF71-1	■ ■ 5 - Z	B41	G ■ ■	H ■ ■	66.1/145.8
	K402	100	1FK7103-5AF71-1	■ ■ 5 - Z	B42	G ■ ■	H ■ ■	66.1/145.8
	K402	100	1FK7103-5AF71-1	■ ■ 5 - Z	B43	G ■ ■	H ■ ■	66.1/145.8
	K513	100	1FK7103-5AF71-1	■ ■ 5 - Z	B53	G ■ ■	H ■ ■	71.9/158.5
	K513	100	1FK7103-5AF71-1	■ ■ 5 - Z	B54	G ■ ■	H ■ ■	71.9/158.5
	K613	100	1FK7103-5AF71-1	■ ■ 5 - Z	B64	G ■ ■	H ■ ■	93.4/206.0
	K513	100	1FK7103-5AF71-1	■ ■ 5 - Z	B55	G ■ ■	H ■ ■	71.9/158.5
	K613	100	1FK7103-5AF71-1	■ ■ 5 - Z	B65	G ■ ■	H ■ ■	93.4/206.0
	K613	100	1FK7103-5AF71-1	■ ■ 5 - Z	B66	G ■ ■	H ■ ■	93.4/206.0
	K713	100	1FK7103-5AF71-1	■ ■ 5 - Z	B76	G ■ ■	H ■ ■	121.7/268.4
	K713	100	1FK7103-5AF71-1	■ ■ 5 - Z	B77	G ■ ■	H ■ ■	121.7/268.4
	K813	100	1FK7103-5AF71-1	■ ■ 5 - Z	B87	G ■ ■	H ■ ■	175.1/386.1
	K713	100	1FK7103-5AF71-1	■ ■ 5 - Z	B78	G ■ ■	H ■ ■	121.7/268.4
	K813	100	1FK7103-5AF71-1	■ ■ 5 - Z	B88	G ■ ■	H ■ ■	175.1/386.1
	K402	100	1FK7105-5AF71-1	■ ■ 5 - Z	B41	G ■ ■	H ■ ■	76.1/167.8
	K402	100	1FK7105-5AF71-1	■ ■ 5 - Z	B42	G ■ ■	H ■ ■	76.1/167.8
	K513	100	1FK7105-5AF71-1	■ ■ 5 - Z	B53	G ■ ■	H ■ ■	82/180.8
	K402	100	1FK7105-5AF71-1	■ ■ 5 - Z	B43	G ■ ■	H ■ ■	76.1/167.8
	K613	100	1FK7105-5AF71-1	■ ■ 5 - Z	B64	G ■ ■	H ■ ■	103/227.1
	K513	100	1FK7105-5AF71-1	■ ■ 5 - Z	B54	G ■ ■	H ■ ■	82/180.8
	K613	100	1FK7105-5AF71-1	■ ■ 5 - Z	B65	G ■ ■	H ■ ■	103/227.1
	K713	100	1FK7105-5AF71-1	■ ■ 5 - Z	B75	G ■ ■	H ■ ■	132/291.1
	K713	100	1FK7105-5AF71-1	■ ■ 5 - Z	B76	G ■ ■	H ■ ■	132/291.1
	K813	100	1FK7105-5AF71-1	■ ■ 5 - Z	B86	G ■ ■	H ■ ■	185/407.9
	K813	100	1FK7105-5AF71-1	■ ■ 5 - Z	B87	G ■ ■	H ■ ■	185/407.9
	K713	100	1FK7105-5AF71-1	■ ■ 5 - Z	B77	G ■ ■	H ■ ■	132/291.1
	K813	100	1FK7105-5AF71-1	■ ■ 5 - Z	B88	G ■ ■	H ■ ■	185/407.9
Encoder systems:		Incremental encoder sin/cos 1 V _{pp}	A					
		Absolute encoder EnDat 2048 pulses/rev. (shaft height 48 and higher)	E					
Motors without DRIVE-CLiQ interface		Absolute encoder EnDat 512 pulses/rev. (only shaft height 36)	H					
		Basic abs. encoder EnDat 32 pulses/rev. (shaft height 48 and higher)	G					
		Res., multi-pole (pole no. = pole no. motor)	S					
		Resolver, 2-pole	T					
Encoder systems:		Incremental encoder sin/cos 1 V _{pp}	D					
		Absolute encoder EnDat 2048 pulses/rev. (shaft height 48 and higher)	F					
Motors with DRIVE-CLiQ interface		Absolute encoder EnDat 512 pulses/rev. (only shaft height 36)	L					
		Basic abs. encoder EnDat 32 pulses/rev. (shaft height 48 and higher)	K					
		Res., multi-pole (pole no. = pole no. motor)	U					
		Resolver, 2-pole	P					
Holding brake:		Motor without holding brake	U					
		Motor with holding brake	V					
Order codes for type, type of construction and mounting position, refer to page 3/86								

9.3 Motors with helical and bevel gearboxes

Selection and ordering data for worm gear motors

Output (S3-60%)	Output speed	Rated output torque	Max. permissible acceleration torque	Nominal ratio	Exact ratio	Cantilever force gearbox shaft extension	Overload factor
P_2 kW/HP	n_2 rpm	M_2 Nm/lb _f -ft	M_{2max} Nm/lb _f -ft	i_{nom}	i_{exact}	$F_{Tpermiss}$ N/lb _f	f_B
0.28/0.38	312	8.5/6.3	43/31.7	9.6	1107/115	1689/379.70	4.1
	172	15.3/11.3	73/53.8	17.5	297/17	1938/435.68	3.9
0.27/0.36	128	20.2/14.9	82/60.4	23	117/5	2271/510.54	3.3
	86	30/22.1	125/92.1	35	873/25	2441/548.76	3.4
0.24/0.32	51	45.6/33.6	88/64.9	59	117/2	3082/692.86	1.6
	52	45.8/33.8	172/126.8	58	405/7	2889/649.48	3.1
	40	57.7/42.5	96/70.8	75	747/10	3343/751.54	1.4
	43	54.8/40.4	184/135.6	70	279/4	3075/691.29	2.7
0.38/0.51	172	21.2/15.6	110/81.1	17.5	297/17	1938/435.68	4.4
	86	41.6/30.7	150/110.6	35	873/25	2441/548.76	3.0
0.35/0.47	52	63.4/46.7	172/126.8	58	405/7	2889/649.48	2.3
	43	75.9/55.9	184/135.6	70	279/4	3075/691.29	2.0
0.73/0.98	172	40.8/30.1	110/81.1	17.5	297/17	1938/435.68	2.3
	130	53.6/39.5	132/97.3	23	162/7	2128/478.40	2.1
0.72/0.97	86	80.1/59	150/110.6	35	873/25	2441/548.76	1.6
	86	79.9/58.9	252/185.7	35	243/7	3411/766.83	2.7
0.66/0.89	52	122/89.9	172/126.8	58	405/7	2889/649.48	1.2
0.69/0.93	52	126/92.9	302/222.6	58	1863/32	4053/911.15	2.1
0.66/0.89	43	146/107.6	184/135.6	70	279/4	3075/691.29	1.1
0.68/0.91	43	151/111.3	324/238.8	70	351/5	4314/969.83	1.9
1.35/1.81	326	39.5/29.1	74/54.5	9.2	46/5	1565/351.83	1.5
1.33/1.78	172	73.7/54.3	110/81.1	17.5	297/17	1938/435.68	1.2
	171	74.4/54.8	217/159.9	17.5	351/20	2717/610.81	2.3
1.31/1.76	129	97.9/72.2	259/190.9	23	1863/80	2986/671.28	2.1
	86	144/106.1	310/228.5	35	243/7	3411/766.83	1.7
	86	146/107.6	498/367	35	2268/65	4881/1097.30	2.7
1.24/1.66	52	227/167.3	302/222.6	58	1863/32	4053/911.15	1.0
	51	232/171	561/413.5	59	117/2	5799/1303.67	1.9
	43	275/202.7	609/448.8	70	2241/32	6157/1384.16	1.7
	43	277/204.1	791/583	70	279/4	7994/1797.13	2.2

Selection and ordering data for worm gear motors

Gearbox size	Motor frame size	Worm geared motors Order No.	Order codes Gearbox type	Type	Type of construction mounting position	Total weight, approx.	
						SH	kg/lb
S002	36	1FK7032-5AK71-1	■ ■ 5 - Z	E03	G ■ ■	H ■ ■	6.6/14.6
S102	36	1FK7032-5AK71-1	■ ■ 5 - Z	E14	G ■ ■	H ■ ■	12.9/28.4
S002	36	1FK7032-5AK71-1	■ ■ 5 - Z	E05	G ■ ■	H ■ ■	6.6/14.6
S102	36	1FK7032-5AK71-1	■ ■ 5 - Z	E16	G ■ ■	H ■ ■	12.9/28.4
S002	36	1FK7032-5AK71-1	■ ■ 5 - Z	E07	G ■ ■	H ■ ■	6.6/14.6
S102	36	1FK7032-5AK71-1	■ ■ 5 - Z	E17	G ■ ■	H ■ ■	12.9/28.4
S002	36	1FK7032-5AK71-1	■ ■ 5 - Z	E08	G ■ ■	H ■ ■	6.6/14.6
S102	36	1FK7032-5AK71-1	■ ■ 5 - Z	E18	G ■ ■	H ■ ■	12.9/28.4
S102	48	1FK7040-5AK71-1	■ ■ 5 - Z	E14	G ■ ■	H ■ ■	13.7/30.2
S102	48	1FK7040-5AK71-1	■ ■ 5 - Z	E16	G ■ ■	H ■ ■	13.7/30.2
S102	48	1FK7040-5AK71-1	■ ■ 5 - Z	E17	G ■ ■	H ■ ■	13.7/30.2
S102	48	1FK7040-5AK71-1	■ ■ 5 - Z	E18	G ■ ■	H ■ ■	13.7/30.2
S102	48	1FK7042-5AF71-1	■ ■ 5 - Z	E14	G ■ ■	H ■ ■	15/33.1
S102	48	1FK7042-5AF71-1	■ ■ 5 - Z	E15	G ■ ■	H ■ ■	15/33.1
S102	48	1FK7042-5AF71-1	■ ■ 5 - Z	E16	G ■ ■	H ■ ■	15/33.1
S202	48	1FK7042-5AF71-1	■ ■ 5 - Z	E26	G ■ ■	H ■ ■	22.5/49.6
S102	48	1FK7042-5AF71-1	■ ■ 5 - Z	E17	G ■ ■	H ■ ■	15/33.1
S202	48	1FK7042-5AF71-1	■ ■ 5 - Z	E27	G ■ ■	H ■ ■	22.5/49.6
S102	48	1FK7042-5AF71-1	■ ■ 5 - Z	E18	G ■ ■	H ■ ■	15/33.1
S202	48	1FK7042-5AF71-1	■ ■ 5 - Z	E28	G ■ ■	H ■ ■	22.5/49.6
S102	63	1FK7060-5AF71-1	■ ■ 5 - Z	E13	G ■ ■	H ■ ■	17.7/39.0
S102	63	1FK7060-5AF71-1	■ ■ 5 - Z	E14	G ■ ■	H ■ ■	17.7/39.0
S202	63	1FK7060-5AF71-1	■ ■ 5 - Z	E24	G ■ ■	H ■ ■	25.2/55.6
S202	63	1FK7060-5AF71-1	■ ■ 5 - Z	E25	G ■ ■	H ■ ■	25.2/55.6
S202	63	1FK7060-5AF71-1	■ ■ 5 - Z	E26	G ■ ■	H ■ ■	25.2/55.6
S302	63	1FK7060-5AF71-1	■ ■ 5 - Z	E36	G ■ ■	H ■ ■	34.4/75.9
S202	63	1FK7060-5AF71-1	■ ■ 5 - Z	E27	G ■ ■	H ■ ■	25.2/55.6
S302	63	1FK7060-5AF71-1	■ ■ 5 - Z	E37	G ■ ■	H ■ ■	34.4/75.9
S302	63	1FK7060-5AF71-1	■ ■ 5 - Z	E38	G ■ ■	H ■ ■	34.4/75.9
S402	63	1FK7060-5AF71-1	■ ■ 5 - Z	E48	G ■ ■	H ■ ■	43.6/96.1
Encoder systems:	Incremental encoder sin/cos 1 V _{pp}	A					
	Absolute encoder EnDat 2048 pulses/rev. (shaft height 48 and higher)	E					
Motors without DRIVE-CLiQ interface	Absolute encoder EnDat 512 pulses/rev. (only shaft height 36)	H					
	Basic abs. encoder EnDat 32 pulses/rev. (shaft height 48 and higher)	G					
	Res., multi-pole (pole no. = pole no. motor)	S					
	Resolver, 2-pole	T					
Encoder systems:	Incremental encoder sin/cos 1 V _{pp}	D					
	Absolute encoder EnDat 2048 pulses/rev. (shaft height 48 and higher)	F					
Motors with DRIVE-CLiQ interface	Absolute encoder EnDat 512 pulses/rev. (only shaft height 36)	L					
	Basic abs. encoder EnDat 32 pulses/rev. (shaft height 48 and higher)	K					
	Res., multi-pole (pole no. = pole no. motor)	U					
	Resolver, 2-pole	P					
Holding brake:	Motor without holding brake	U					
	Motor with holding brake	V					
Order codes for type, type of construction and mounting position, refer to page 3/86						.	.

Selection and ordering data for worm gear motors

Output (S3-60%)	Output speed	Rated output torque	Max. permissible acceleration torque	Nominal ratio	Exact ratio	Cantilever force gearbox shaft extension	Overload factor
P_2 kW/HP	n_2 rpm	M_2 Nm/lb _f -ft	M_{2max} Nm/lb _f -ft	i_{nom}	i_{exact}	$F_{Tpermiss}$ N/lb _f	f_B
2.11/2.83	325	61.9/45.6	126/92.9	9.2	1431/155	2194/493.23	1.4
2.08/2.79	171	116/85.5	217/159.9	17.5	351/20	2717/610.81	1.2
2.05/2.75	129	152/112	259/190.9	23	1863/80	2986/671.28	1.1
	86	227/167.3	498/367	35	2268/65	4881/1097.30	1.5
1.92/2.57	51	360/265.3	561/413.5	59	117/2	5799/1303.67	1.0
1.94/2.60	43	430/316.9	791/583	70	279/4	7994/1797.13	1.2
1.93/2.59	171	108/79.6	217/159.9	17.5	351/20	2717/610.81	1.7
	173	107/78.9	373/274.9	17.5	1998/115	3869/869.49	3.0
	129	142/104.7	259/190.9	23	1863/80	2986/671.28	1.6
	128 86	144/106.1 213/157	458/337.5 720/530.6	23 35	117/5 873/25	4273/960.61 6347/1426.87	2.7 2.9
1.79/2.40	51	335/246.9	561/413.5	59	117/2	5799/1303.67	1.4
	43	399/294.1	609/448.8	70	2241/32	6157/1384.16	1.3
3.05/4.09	322	90.5/66.7	216/159.2	9.3	270/29	3143/706.58	1.6
3.01/4.04	173	166/122.3	373/274.9	17.5	1998/115	3869/869.79	1.5
3.03/4.06	172	168/123.8	557/410.5	17.5	612/35	5040/1133.04	2.2
2.98/4.00	128	222/163.6	458/337.5	23	117/5	4273/960.61	1.4
	128	222/163.6	685/504.8	23	117/5	5554/1248.59	2.0
2.95/3.96	86	328/241.7	720/530.6	35	873/25	6347/1426.87	1.4
3.47/4.65	259	128/94.3	371/274.9	11.5	81/7	4392/987.37	1.9
3.44/4.61	172	191/140.8	557/410.5	17.5	612/35	5040/1133.04	1.9
4.50/6.03	259	166/122.3	371/273.4	11.5	81/7	4392/987.37	1.3
4.45/5.97	172	247/182	557/410.5	17.5	612/35	5040/1133.04	1.3

Selection and ordering data for worm gear motors

Gearbox size	Motor frame size	Worm geared motors Order No.	Order codes Gearbox type	Type	Type of construction mounting position	Total weight, approx.
						kg/lb
	SH					
S202	63	1FK7063-5AF71-1 ■ ■ 5 - Z	E23	G ■ ■	H ■ ■	28.9/63.7
S202	63	1FK7063-5AF71-1 ■ ■ 5 - Z	E24	G ■ ■	H ■ ■	28.9/63.7
S202	63	1FK7063-5AF71-1 ■ ■ 5 - Z	E25	G ■ ■	H ■ ■	28.9/63.7
S302	63	1FK7063-5AF71-1 ■ ■ 5 - Z	E36	G ■ ■	H ■ ■	38.1/84.0
S302	63	1FK7063-5AF71-1 ■ ■ 5 - Z	E37	G ■ ■	H ■ ■	38.1/84.0
S402	63	1FK7063-5AF71-1 ■ ■ 5 - Z	E48	G ■ ■	H ■ ■	47.3/104.3
S202	80	1FK7080-5AF71-1 ■ ■ 5 - Z	E24	G ■ ■	H ■ ■	28.6/63.1
S302	80	1FK7080-5AF71-1 ■ ■ 5 - Z	E34	G ■ ■	H ■ ■	37.8/83.4
S202	80	1FK7080-5AF71-1 ■ ■ 5 - Z	E25	G ■ ■	H ■ ■	28.6/63.1
S302	80	1FK7080-5AF71-1 ■ ■ 5 - Z	E35	G ■ ■	H ■ ■	37.8/83.4
S402	80	1FK7080-5AF71-1 ■ ■ 5 - Z	E46	G ■ ■	H ■ ■	47/103.6
S302	80	1FK7080-5AF71-1 ■ ■ 5 - Z	E37	G ■ ■	H ■ ■	37.8/83.4
S302	80	1FK7080-5AF71-1 ■ ■ 5 - Z	E38	G ■ ■	H ■ ■	37.8/83.4
S302	80	1FK7083-5AF71-1 ■ ■ 5 - Z	E33	G ■ ■	H ■ ■	43/94.8
S302	80	1FK7083-5AF71-1 ■ ■ 5 - Z	E34	G ■ ■	H ■ ■	43/94.8
S402	80	1FK7083-5AF71-1 ■ ■ 5 - Z	E44	G ■ ■	H ■ ■	52.2/115.1
S302	80	1FK7083-5AF71-1 ■ ■ 5 - Z	E35	G ■ ■	H ■ ■	43/94.8
S402	80	1FK7083-5AF71-1 ■ ■ 5 - Z	E45	G ■ ■	H ■ ■	52.2/115.1
S402	80	1FK7083-5AF71-1 ■ ■ 5 - Z	E46	G ■ ■	H ■ ■	52.2/115.1
S402	100	1FK7100-5AF71-1 ■ ■ 5 - Z	E43	G ■ ■	H ■ ■	54.4/120.2
S402	100	1FK7100-5AF71-1 ■ ■ 5 - Z	E44	G ■ ■	H ■ ■	54.4/120.2
S402	100	1FK7101-5AF71-1 ■ ■ 5 - Z	E43	G ■ ■	H ■ ■	60/132.3
S402	100	1FK7101-5AF71-1 ■ ■ 5 - Z	E44	G ■ ■	H ■ ■	60/132.3
Encoder systems:	Incremental encoder sin/cos 1 V _{pp}	A				
Motors without DRIVE-CLiQ interface	Absolute encoder EnDat 2048 pulses/rev. (shaft height 48 and higher)	E				
	Absolute encoder EnDat 512 pulses/rev. (only shaft height 36)	H				
	Basic abs. encoder EnDat 32 pulses/rev. (shaft height 48 and higher)	G				
	Res., multi-pole (pole no. = pole no. motor)	S				
	Resolver, 2-pole	T				
Encoder systems:	Incremental encoder sin/cos 1 V _{pp}	D				
Motors with DRIVE-CLiQ interface	Absolute encoder EnDat 2048 pulses/rev. (shaft height 48 and higher)	F				
	Absolute encoder EnDat 512 pulses/rev. (only shaft height 36)	L				
	Basic abs. encoder EnDat 32 pulses/rev. (shaft height 48 and higher)	K				
	Res., multi-pole (pole no. = pole no. motor)	U				
	Resolver, 2-pole	P				
Holding brake:	Motor without holding brake	U				
	Motor with holding brake	V				

Order codes for type, type of construction and mounting position, refer to page 3/86

Order codes for 1FK7 servo gear motors

Order no. for geared motor + order codes

1FK7 ...-.5A.71-1..5-Z

□ □ □ G □ □ H □ □

1st order code, Gear type <ul style="list-style-type: none"> • Bevel gear unit K 102 to K 813 • Offset shaft gear unit F 202 to F 602 • Helical gear unit C 002 to C 812 • Worm gear unit S 002 to S 402 For complete order code for gear type, see selection and ordering data on pages 3/64 to 3/85		B	C	D	E	G	1	H	1
2nd order code, 1st and 2nd positions: Type <ul style="list-style-type: none"> • Foot-mounted • Tapped hole group • Flange (round) • Foot-mounted and flange (round) • Foot-mounted and tapped hole group 						G	2		
2nd order code, 3rd position: Gear unit shaft end Helical gear unit: <ul style="list-style-type: none"> • Solid shaft with fitted key Offset shaft gear unit: <ul style="list-style-type: none"> • Solid shaft with fitted key, gearbox side 5 • Hollow shaft with keyway, insertion gearbox side 5 • Hollow shaft with tensioning element, shrink disk, side 6, insertion gearbox side 5 For bevel and worm gearboxes: <ul style="list-style-type: none"> • Solid shaft with fitted key, gearbox side 4 • Hollow shaft with keyway, insertion gearbox side 4 • Hollow shaft with tensioning element, shrink disk, side 4, insertion gearbox side 3 • Solid shaft with fitted key, gearbox side 3 • Hollow shaft with keyway, insertion gearbox side 3 • Hollow shaft with tensioning element, shrink disk, side 3, insertion gearbox side 4 							3		
3rd order code, 1st and 2nd positions: Type of construction/mounting position <u>Type of construction for</u> Helical gear unit: <ul style="list-style-type: none"> • IM B3 / IM B5 / IM B14 / IM B34 / IM B35 • IM B7 • IM B8 • IM B6 • IM V1 • IM V3 / IM V6 / IM V19 • IM V5 • IM V18 <u>Mounting position for</u> Offset shaft, bevel and worm gearboxes: <ul style="list-style-type: none"> • EL 1 • EL 2 • EL 3 • EL 4 • EL 5 • EL 6 – – 							4	H	1
3rd order code, 3rd position: Connector attachment position <ul style="list-style-type: none"> • Connector position on gearbox side 2 • Connector position on gearbox side 4 • Connector position on gearbox side 1 • Connector position on gearbox side 3 									2
									3
									4

9.3 Motors with helical and bevel gearboxes

Order no. geared motor + order codes

Order no. geared motor + order codes			Q	□	□	and	G	2	or	□ ¹⁾	G	2	□ ¹⁾
4th order code,													
torque bracket for bevel (K) and worm gear units (S)													
Torque bracket position		Gear unit type and size											
Torque bracket	Side 1, eye side 4	K 102, S 102		Q	1	2	G	2	3	G	2	8	
	Side 1, eye side 3	K 102, S 102		Q	1	3	G	2	7	G	2	4	
	Side 5, eye side 4	K 102, S 102		Q	1	4	G	2	3	G	2	8	
	Side 5, eye side 3	K 102, S 102		Q	1	5	G	2	7	G	2	4	
	Side 2, eye side 4	K 102		Q	1	6	G	2	3	G	2	8	
	Side 2, eye side 3	K 102		Q	1	7	G	2	7	G	2	4	
Torque bracket	Side 1, eye side 4	K 202, S 202		Q	2	2	G	2	3	G	2	8	
	Side 1, eye side 3	K 202, S 202		Q	2	3	G	2	7	G	2	4	
	Side 5, eye side 4	K 202, S 202		Q	2	4	G	2	3	G	2	8	
	Side 5, eye side 3	K 202, S 202		Q	2	5	G	2	7	G	2	4	
Torque bracket	Side 1, eye side 4	K 302, S 302		Q	3	2	G	2	3	G	2	8	
	Side 1, eye side 3	K 302, S 302		Q	3	3	G	2	7	G	2	4	
	Side 5, eye side 4	K 302, S 302		Q	3	4	G	2	3	G	2	8	
	Side 5, eye side 3	K 302, S 302		Q	3	5	G	2	7	G	2	4	
Torque bracket	Side 1, eye side 4	K 402, S 402		Q	4	2	G	2	3	G	2	8	
	Side 1, eye side 3	K 402, S 402		Q	4	3	G	2	7	G	2	4	
	Side 5, eye side 4	K 402, S 402		Q	4	4	G	2	3	G	2	8	
	Side 5, eye side 3	K 402, S 402		Q	4	5	G	2	7	G	2	4	
Torque bracket	Side 1, eye side 4	K 513		Q	5	2	G	2	3	G	2	8	
	Side 1, eye side 3	K 513		Q	5	3	G	2	7	G	2	4	
	Side 5, eye side 4	K 513		Q	5	4	G	2	3	G	2	8	
	Side 5, eye side 3	K 513		Q	5	5	G	2	7	G	2	4	
Torque bracket	Side 1, eye side 4	K 613		Q	6	2	G	2	3	G	2	8	
	Side 1, eye side 3	K 613		Q	6	3	G	2	7	G	2	4	
	Side 5, eye side 4	K 613		Q	6	4	G	2	3	G	2	8	
	Side 5, eye side 3	K 613		Q	6	5	G	2	7	G	2	4	
Torque bracket	Side 1, eye side 4	K 713		Q	7	2	G	2	3	G	2	8	
	Side 1, eye side 3	K 713		Q	7	3	G	2	7	G	2	4	
	Side 5, eye side 4	K 713		Q	7	4	G	2	3	G	2	8	
	Side 5, eye side 3	K 713		Q	7	5	G	2	7	G	2	4	
Torque bracket	Side 1, eye side 4	K 813		Q	8	2	G	2	3	G	2	8	
	Side 1, eye side 3	K 813		Q	8	3	G	2	7	G	2	4	
	Side 5, eye side 4	K 813		Q	8	4	G	2	3	G	2	8	
	Side 5, eye side 3	K 813		Q	8	5	G	2	7	G	2	4	

¹⁾ Options Q12 to Q85 can be combined only with the following order codes:
B.. or E.. with G23 or G24 or G27 or G28

Gearbox

9.3 Motors with helical and bevel gearboxes

5th order code, other options

Paint finish, matt black RAL 9005

Paint finish, cream white RAL 9001

Paint finish, reseda green RAL 6011

Paint finish, pebble gray RAL 7032

Paint finish, sky blue RAL 5015

Paint finish, light ivory RAL 1015

Paint finish, ash gray RAL 7000

Paint finish, white aluminum RAL 9006

Paint finish, gentian blue RAL 5010

Paint finish, pure orange RAL 2004

Food-grade gear oil (1FK7... - 5A.71 - 1...7 - Z)

X	0	1
X	0	2
X	0	3
X	0	4
X	0	5
X	0	6
X	0	7
X	0	8
X	1	2
X	1	9
Q	9	0

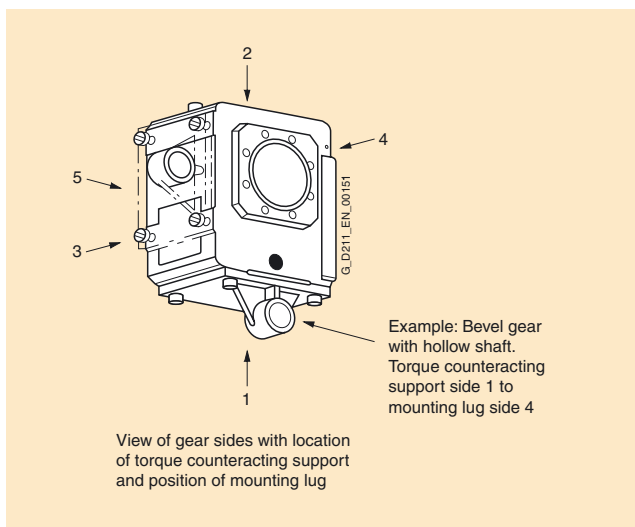

Overview of possible combinations of option Gxx with Hxx and Qxx

Description of options	Gear type				Permissible H options		
	Helical	Offset shaft	Bevel	Worm	Permissible H option for helical	Permissible H option for offset shaft	Permissible H option for bevel and worm
	Order code for option Gxx				Order code for option Hxx		
G11 Foot-mounted, solid shaft with fitted key	✓				H1x to H4x		
G13 Footed-mounted, hollow shaft with keyway (insertion gearbox side 4)							
G14 Footed-mounted, hollow shaft with shrink disk (insertion gearbox side 4)							
G15 Foot-mounted, solid shaft with fitted key (gearbox side 3)							
G17 Footed-mounted, hollow shaft with keyway (insertion gearbox side 3)							
G18 Footed-mounted, hollow shaft with shrink disk (gearbox side 3)							
G21 Tapped hole group, solid shaft with keyway (gearbox side 4 for bevel and worm)	✓		✓	✓ ¹⁾	H1x, H6x, H8x		H1x to H6x
G23 Tapped hole group, solid shaft with keyway (insertion gearbox side 5 for offset shaft, insertion gearbox side 4 for bevel and worm)		✓	✓	✓ ¹⁾		H1x to H6x	H1x to H6x, Qxx
G24 Tapped hole group, hollow shaft with tensioning element (shrink disk on gearbox side 6 and insertion side 5 for offset shaft; shrink disk on gearbox side 4 and insertion side 3 for bevel and worm)		✓	✓	✓ ¹⁾			
G25 Tapped hole group, solid shaft with fitted key (gearbox side 3)			✓	✓ ¹⁾			H1x to H6x
G27 Tapped hole group, hollow shaft with fitted key (insertion gearbox side 3)			✓	✓ ¹⁾			H1x to H6x, Qxx
G28 Tapped hole group, hollow shaft with tensioning element (shrink disk on gearbox side 3 and insertion side 4 for bevel and worm)			✓	✓ ¹⁾			
G31 Flange (round), solid shaft with fitted key (gearbox side 5 for offset shaft; side 4 for bevel and worm)	✓	✓	✓	✓ ¹⁾	H1x, H5x, H6x	H1x to H6x	H1x to H6x
G33 Flange (round), hollow shaft with keyway (insertion gearbox side 4)		✓	✓	✓ ¹⁾			
G34 Flange (round), hollow shaft with tensioning element, shrink disk on gearbox side 6 and insertion side 5 for offset shaft; shrink disk on gearbox side 4 and insertion side 3 for bevel and worm)		✓	✓	✓ ¹⁾			
G35 Flange (round), solid shaft with fitted key (gearbox side 3)			✓	✓ ¹⁾			
G37 Flange (round), hollow shaft with keyway (insertion gearbox side 3)			✓	✓ ¹⁾			
G38 Flange (round), hollow shaft with tensioning element (shrink disk on gearbox side 3 and insertion side 4 for bevel and worm)			✓	✓ ¹⁾			

Qxx: New options, torque bracket
H2x: Construction type IM B7 for helical gearboxes

¹⁾ Not for worm gear size S002 (E0x).

Overview of possible combinations of option Gxx with Hxx and Qxx

		Gear type				Permissible H options		
		Helical	Offset shaft	Bevel	Worm	Permissible H option for helical	Permissible H option for offset shaft	Permissible H option for bevel and worm
Description of options		Order code for option Gxx				Order code for option Hxx		
G51	Foot-mounted and flange (round), solid shaft with fitted key (gearbox side 4 for bevel and worm)	✓ ¹⁾		✓ ²⁾	✓	H1x, H2x		H1x to H6x
G53	Foot-mounted and flange (round), hollow shaft with keyway (insertion gearbox side 4)			✓	✓			
G54	Foot-mounted and flange (round), hollow shaft with tensioning element (shrink disk on gearbox side 4 and insertion side 4 for bevel and worm)			✓	✓			
G55	Foot-mounted and flange (round), solid shaft with fitted key (gearbox side 3)			✓	✓			
G57	Foot-mounted and flange (round), hollow shaft with keyway (insertion gearbox side 3)			✓	✓			
G58	Foot-mounted and flange (round), hollow shaft with tensioning element (shrink disk on gearbox side 3 and insertion side 4 for bevel and worm)			✓	✓			
G61	Foot-mounted and tapped hole group, solid shaft with fitted key (gearbox side 4 for bevel and worm)	✓		✓	✓	H1x, H2x		H1x to H6x
G63	Foot-mounted and tapped hole group, hollow shaft with keyway (insertion gearbox side 4)			✓	✓			
G64	Foot-mounted and tapped hole group, hollow shaft with tensioning element (shrink disk on gearbox side 4 and insertion side 4 for bevel and worm)			✓	✓			
G65	Foot-mounted and tapped hole group, solid shaft with fitted key (gearbox side 3)			✓	✓			
G67	Foot-mounted and tapped hole group, hollow shaft with keyway (insertion gearbox side 3)			✓	✓			
G68	Foot-mounted and tapped hole group, hollow shaft with tensioning element (shrink disk on gearbox side 3 and insertion side 4 for bevel and worm)			✓	✓			

Qxx: New options, torque bracket
H2x: Construction type IM B7 for helical gearboxes

1) The flange diameter for helical gearboxes with foot mounting and flange is one diameter grade smaller in each case than the diameter for helical units with flange only (without foot mounting).

2) Only for 1FK706. to 1FK10. with gear unit size K 513 to K 813 (B5x to B8x). These values refer to $n = 2500$ rpm.

9.3.3 Types of construction and mounting positions

Helical gear motors - types of construction

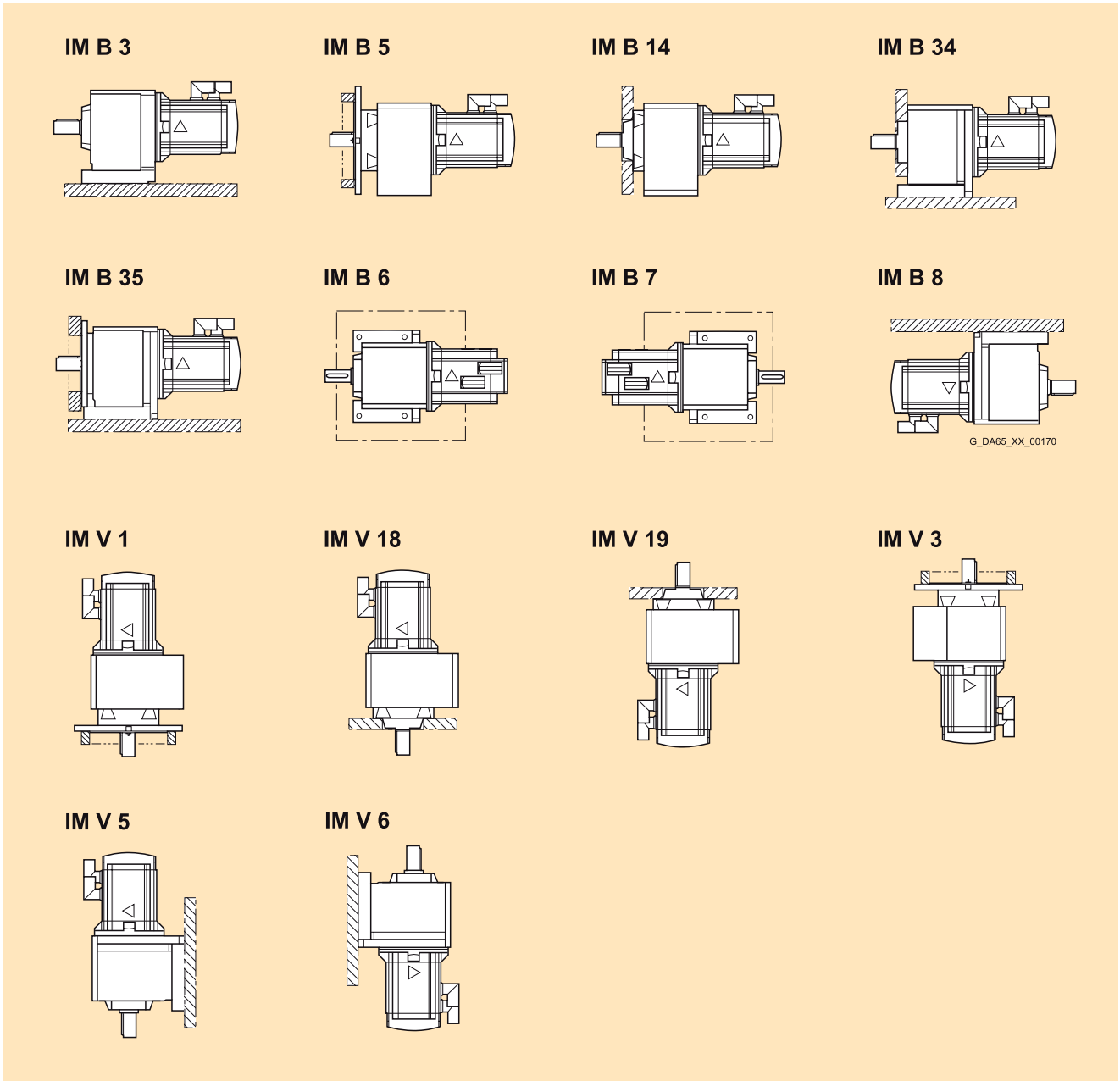

Flat gear motors - mounting positions EL 1 to EL 6

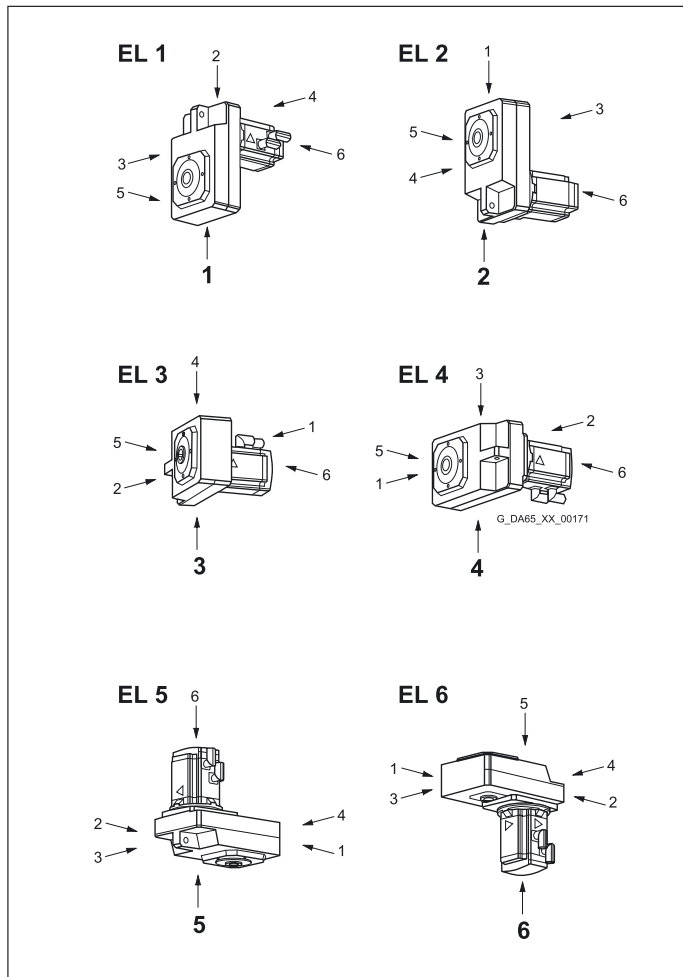

Bevel gear motors - mounting positions EL 1 to EL 6

Gear unit sizes K1 to K4

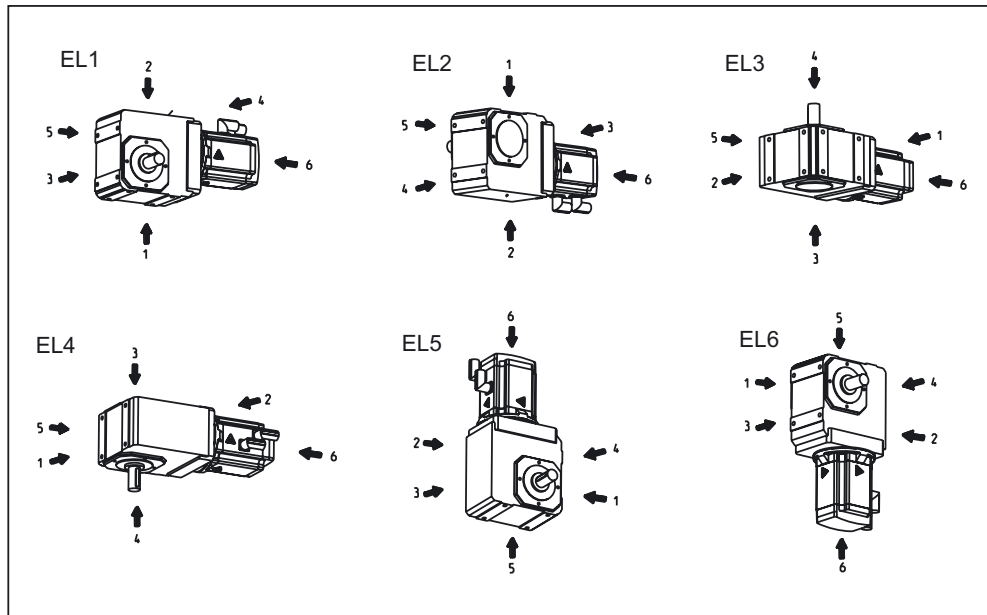

Gear unit sizes K5 to K8

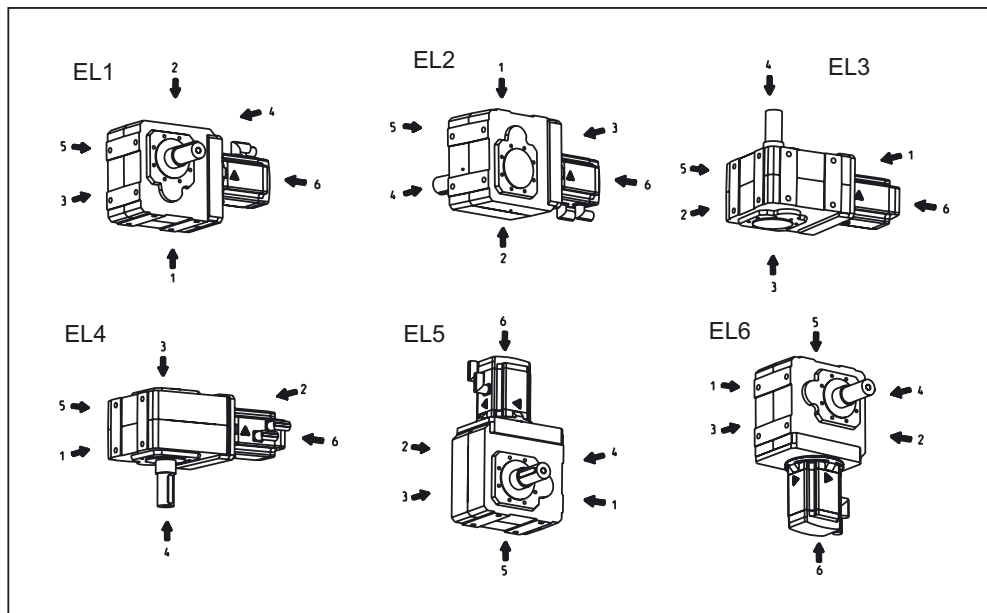

With foot-mounted versions, the feet are always on gearbox side 1.

Worm gear motors - mounting positions EL 1 to EL 6

Gear unit size S0

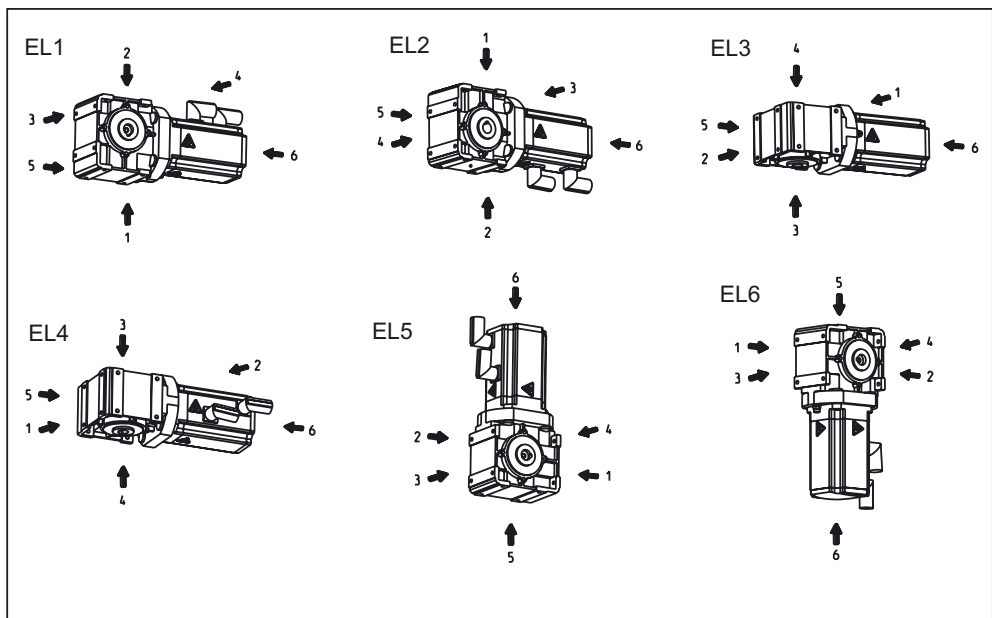

Gear unit sizes S1 to S4

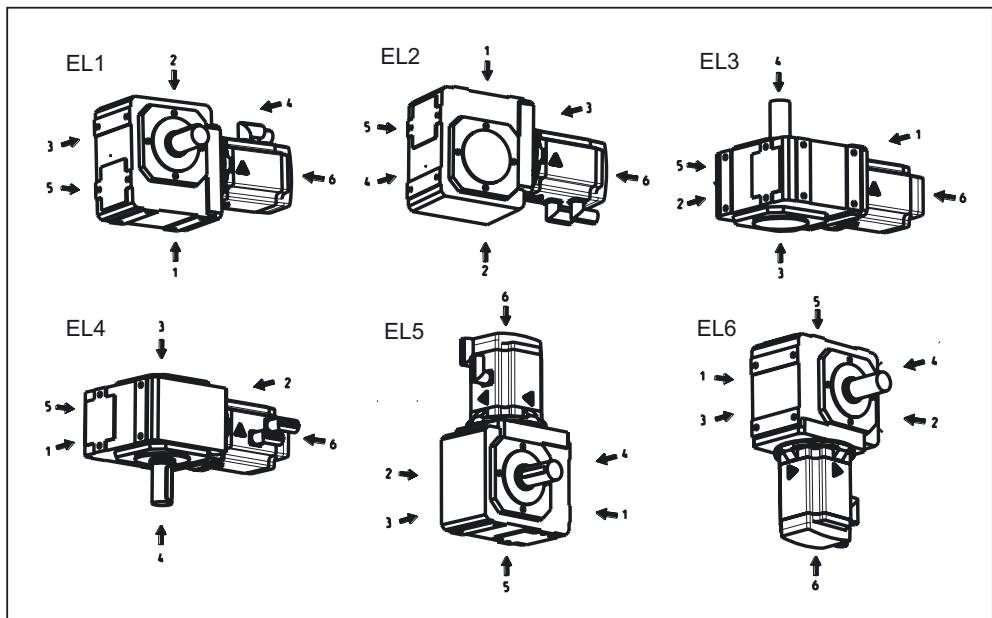

With foot-mounted versions, the feet are always on gearbox side 1.

Plug connection position

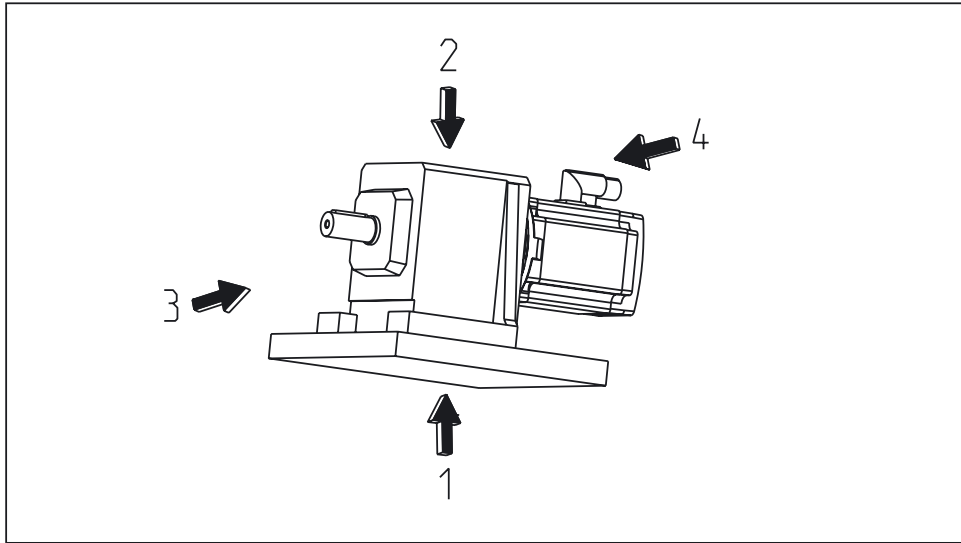

Appendix

A.1 References

An overview of publications that is updated monthly is provided in a number of languages in the Internet at:

<http://www.siemens.com/motioncontrol>
through "Support", "Technical Documentation", "Documentation Overview"

General Documentation

/D 21.1/	SINAMICS S120 Catalog Built-in converter units 0.12 kW to 1200 kW
/NC 60/	SINUMERIK and SIMODRIVE Catalog Automation Systems for Machine Tools
/NC 61/	SINUMERIK and SINAMICS Catalog Automation Systems for Machine Tools
/DA65.3/	SIMOVERT MASTERDRIVES Catalog Synchronous and Induction Motors for SIMOVERT MASTERDRIVES

Electronic Documentation

- /CD1/** **DOC ON CD**
The SINUMERIK System
(includes all SINUMERIK 840D/810D and SIMODRIVE 611D)
- /CD2/** **DOC ON CD**
The SINAMICS System

Manufacturer/Service Documentation

- /PJAL/** **Configuration Manual, Synchronous Motors**
SIMODRIVE 611, SIMOVERT MASTERDRIVES MC
Synchronous Motors General Section
- /PFK7S/** **Configuration Manual, Synchronous Motors**
SINAMICS S120
1FK7 Synchronous Motors
- /PFT6S/** **Configuration Manual, Synchronous Motors**
SINAMICS S120
1FT6 Synchronous Motors
- /PMH2/** **Configuration Manual, Hollow-Shaft Measuring System**
SINAMICS S120, SIMODRIVE 611, SIMOVERT MASTERDRIVES,
SIMAG H2 Hollow-Shaft Measuring System
- /PFK7/** **Configuration Manual, Synchronous Motors**
SIMODRIVE 611, SIMOVERT MASTERDRIVES
1FK7 Synchronous Motors
- /PFT6/** **Configuration Manual, Synchronous Motors**
SIMODRIVE 611, SIMOVERT MASTERDRIVES
1FT6 Synchronous Motors

/PFK6/	Configuration Manual, Synchronous Motors SIMODRIVE 611, SIMOVERT MASTERDRIVES 1FK6 Synchronous Motors
/PFS6/	Configuration Manual, Synchronous Motors SIMOVERT MASTERDRIVES 1FS6 Synchronous Motors, Explosion-Protected
/PFU/	Configuration Manual, Synchronous Motors SINAMICS S120, SIMOVERT MASTERDRIVES, MICROMASTER SIEMOSYN Synchronous Motors 1FU8
/ASAL/	Configuration Manual, Induction Motors SIMODRIVE 611, SIMOVERT MASTERDRIVES Induction Motors General Section
/APH2/	Configuration Manual, Asynchronous Motors SIMODRIVE 611 1PH2 Induction Motors
/APH4/	Configuration Manual, Asynchronous Motors SIMODRIVE 611 1PH4 Induction Motors
/APH7/	Configuration Manual, Asynchronous Motors SIMODRIVE 611 1PH7 Induction Motors
/PPM/	Configuration Manual, Hollow-Shaft Motors SIMODRIVE 611 Hollow Shaft Motors for Main Spindle Drives 1PM6 and 1PM4

/PJFE/	Configuration Manual, Synchronous Build-in Motors SIMODRIVE 611 Synchronous Motors for Main Spindle Drives 1FE1 Synchronous Build-in Motors
/PJTM/	Configuration Manual, Build-in Torque Motors SIMODRIVE 611 Build-in Torque Motors 1FW6
/PJLM/	Configuration Manual, Linear Motors SIMODRIVE 611 Linear Motors 1FN1 and 1FN3
/PMS/	Configuration Manual, ECS Motor Spindle SIMODRIVE 611 ECS Motor Spindle 2SP1
/APL6/	Configuration Manual, Asynchronous Motors SIMOVERT MASTERDRIVES VC/MC Induction Motors 1PL6
/APH7M/	Configuration Manual, Asynchronous Motors SIMOVERT MASTERDRIVES VC/MC Induction Motors 1PH7
/PKTM/	Configuration Manual, Complete Torque Motors SIMOVERT MASTERDRIVES Complete Torque Motors 1FW3

If you come across any misprints in this document, please let us know using this form.
We would also be grateful for any suggestions and recommendations for improvement.

On: SIEMENS AG A&D MC MS1 Postfach 3180 D-91050 Erlangen, Germany Telefax.: +49 (0) 9131 / 98 - 63315 (documentation) mailto:docu.motioncontrol@siemens.com http://www.siemens.com/automation/service&support	From
	Name:
	Company/dept.
	Street:
	Zip code: Location:
	Telephone: /
Telefax: /	

Suggestions and/or corrections

Index

A

Absolute value encoder, 75
Armature short-circuit braking, 84
Axial force stressing, 31

B

Balancing, 37
Bearing version, 37
Brake resistors, 84
 Dimensioning, 87

C

CAD CREATOR, 177
Cantilever force stressing, 30
Configuring
 SIZER, 54
 STARTER, 56
Coupling outputs, 89

D

Danger and warning information, 7
Disposal, 7
Drive coupling, 90
Drive ES, 58

E

Effects on mounting, 25
Encoders, 71
Engineering System, 58
ESDS instructions, 9

H

Holding brake, 79
Hotline, 6

I

Incremental encoders, 73
Induced vibrations, 30

R

Resolver, 77

S

Shaft end, 37
SIZER, 54
STARTER, 56

T

Technical data

1FK7011-5AK21, 156
1FK7011-5AK71, 92
1FK7015-5AK21, 158
1FK7015-5AK71, 94
1FK7022 - 5AK71, 96
1FK7022-5AK21, 160
1FK7032-5AF21, 162
1FK7032-5AK71, 98
1FK7033-7AF21, 164
1FK7033-7AK71, 134
1FK7034-5AF21, 166
1FK7034-5AK71, 100
1FK7040-5AK71, 102
1FK7042-5AF21, 168
1FK7042-5AF71, 104
1FK7042-5AK71, 106
1FK7043-7AF21, 170
1FK7043-7AH71, 136
1FK7043-7AK71, 138
1FK7044-7AF71, 140
1FK7044-7AH71, 142
1FK7060-5AF71, 108
1FK7060-5AH71, 110
1FK7061-7AF71, 144

1FK7061-7AH71, 146
1FK7063-5AF71, 112
1FK7063-5AH71, 114
1FK7064-7AF71, 148
1FK7064-7AH71, 150
1FK7080-5AF71, 116
1FK7080-5AH71, 118
1FK7083-5AF71, 120
1FK7083-5AH71, 122
1FK7085-7AF71, 152
1FK7086-7AF71, 154
1FK7100-5AF71, 124
1FK7101-5AF71, 126
1FK7103-5AF71, 128
1FK7105-5AC71, 130
1FK7105-5AF71, 132

Technical Data

1FK7 Compact, 18
1FK7 High Dynamic, 20

Technical features, 16

Technical Support, 6

Temperature sensor, KTY 84, 69

Thermal motor protection, 69

Torque characteristics, 40

V

Vibration severity grade, 37