



Magnetically latched lighting contactor
60 Amp
5NO / 0NC Poles
Maximum voltage rating 600VAC
Control voltage 440/480VAC 50/60Hz
NEMA Type 1 enclosure

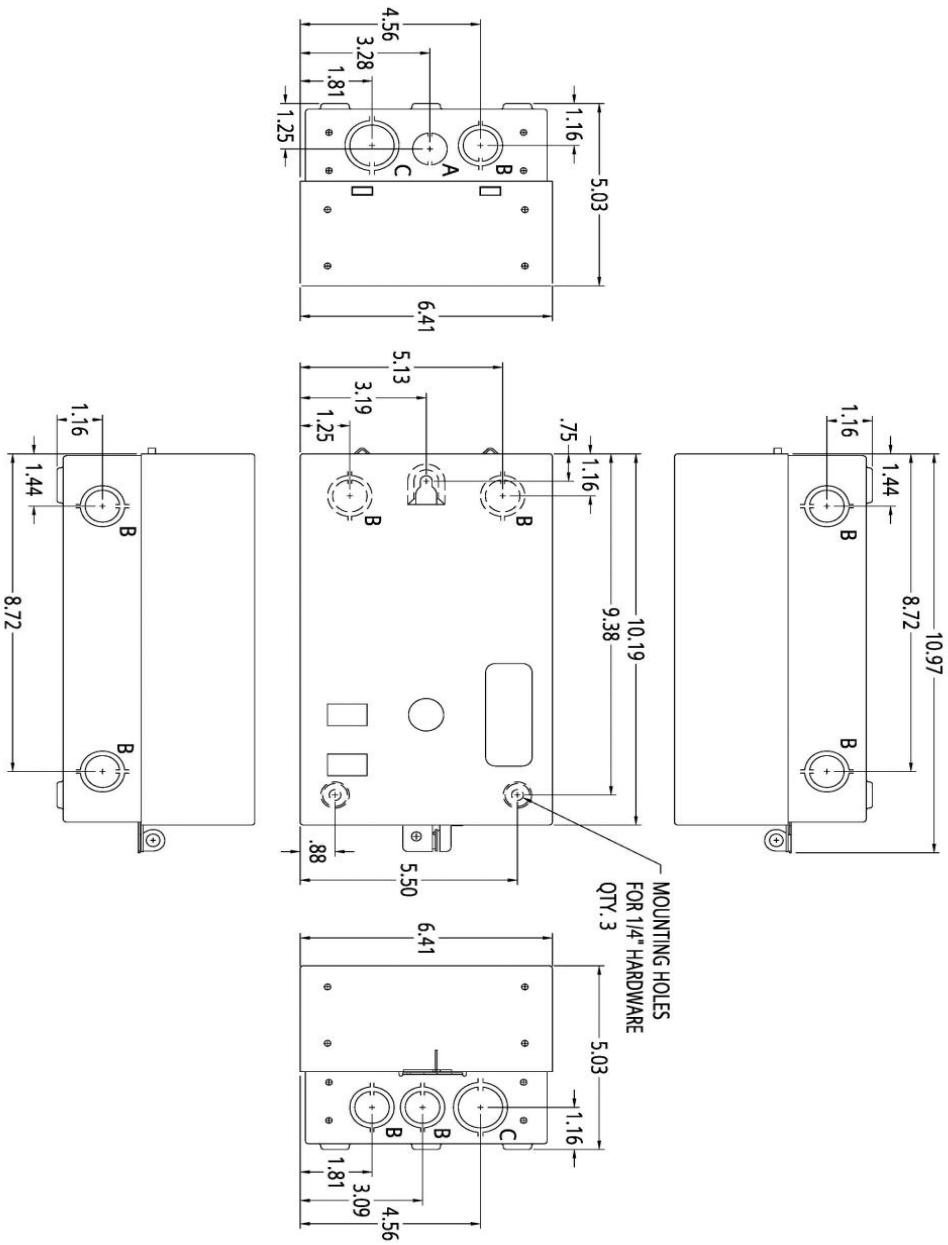

Image is representative and may not depict the actual product.

General technical data:	
Weight	8 lb
Height x Width x Depth	11 x 7 x 5 in.
Finger-safe (main circuit / control circuit)	NA / NA
Maximum altitude	6560 ft
Ambient storage temperature	(no data)
Ambient operating temperature	(no data)
Humidity (% non-condensing)	(no data)
Country of origin	USA
Contactors:	
Number of poles	5NO / 0NC
Mechanical operating cycles	10,000,000
Current ratings:	
Tungsten (poles per phase)	60A @277V 1p 1ph
	60A @480V 2p 1ph
	60A @480V 3p 3ph
Ballast (poles per phase)	60A @347V 1p 1ph
	60A @600V 2p 1ph
	60A @600V 3p 3ph
General & resistive (poles per phase)	60A @347V 1p 1ph
	60A @600V 2p 1ph
	60A @600V 3p 3ph
Internal/standard auxiliary contact:	
Number of NC / NO auxiliary contacts	0NC / 0NO
Rating	NA
Optional auxiliary contact:	
Max number of NC / NO auxiliary contacts	4 max NC/NO combination
Rating	10A@600VAC (A600), 1A@300VDC (R300)
Coil:	
Voltage	440/480V 50/60Hz Coil
Sealed watts	(no data)
Inrush / sealed power	600 / 40 VA
Normal coil operating limits (% of rated voltage)	85% - 110%
Typical drop-out volts (% of rated voltage)	(no data)
Pick-up time / Drop-out time	(no data)
Disconnect type (none):	
Rating	NA
Fuse type accepted	NA

Enclosure:	
Type	NEMA Type 1 enclosure
Rating	Indoor general purpose use
Mounting/wiring:	
Mounting orientation	Vertical
Mounting type	Surface
Line side connection type / torque	Box lug / 45 - 50 lb-in.
Line side solid & stranded conductors	14 - 4 AWG 75°C AL or CU
Load side connection type / torque	Box lug / 45 - 50 lb-in.
Load side solid & stranded conductors	14 - 4 AWG 75°C AL or CU
Coil connection type / torque	Screw / 8 - 12 lb in.
Coil solid & stranded conductors	2 x (16 - 12 AWG) CU 75°C
Main auxiliary contact connection type / torque	NA
Main auxiliary contact solid & stranded conductors	NA
Short circuit current rating:	
Fuses	none
Thermal magnetic circuit breaker	5kA@600V (60A max CB)
Additional information:	
	Brochure

OUTLINE 11X7X5 (SIZE 1) NEMA 1



MOUNTING HOLES
FOR 1/4" HARDWARE
QTY. 3

LETTER	KNOCKOUT & CONDUIT SIZE
A	7/8" DIA. FOR 1/2" CONDUIT
B	7/8" X 1-1/8" DIA. FOR 1/2" & 3/4" CONDUIT
C	1-1/8" X 1-3/8" DIA. FOR 3/4" & 1" CONDUIT

DIMENSIONS ARE IN INCHES.
FILE NAME: SFS-D68870001-0211

Wiring Diagram Class CLM 30-200 Amp 2, 3, 4 and 5 Pole

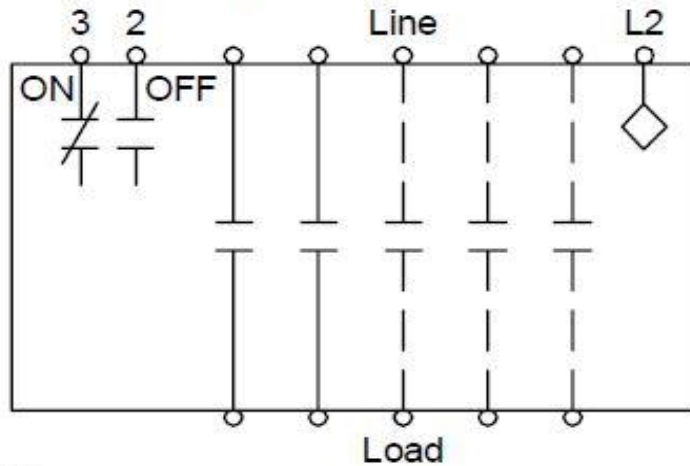

Notes:

1. Dotted lines represent additional poles. Contactor may have 2, 3, 4 or 5 poles.
2. Optional auxiliary contacts are not shown.