

# SIEMENS

## SIMATIC

### Industrial PC SIMATIC IPC377E

#### Operating Instructions

#### Preface

---

#### Overview

---

1

#### Safety instructions

---

2

#### Installing and connecting the device

---

3

#### Commissioning the device and device functions

---

4

#### Operating the device

---

5

#### Expanding and assigning parameters to the device

---

6

#### Maintaining and repairing the device

---

7

#### Technical specifications

---

8

#### Appendix Motherboard

---

A

#### Technical Support

---

B

#### Markings and symbols

---

C

#### List of abbreviations

---

D

## Legal information

### Warning notice system

This manual contains notices you have to observe in order to ensure your personal safety, as well as to prevent damage to property. The notices referring to your personal safety are highlighted in the manual by a safety alert symbol, notices referring only to property damage have no safety alert symbol. These notices shown below are graded according to the degree of danger.

<b>⚠ DANGER</b>
indicates that death or severe personal injury <b>will</b> result if proper precautions are not taken.
<b>⚠ WARNING</b>
indicates that death or severe personal injury <b>may</b> result if proper precautions are not taken.
<b>⚠ CAUTION</b>
indicates that minor personal injury can result if proper precautions are not taken.
<b>NOTICE</b>
indicates that property damage can result if proper precautions are not taken.

If more than one degree of danger is present, the warning notice representing the highest degree of danger will be used. A notice warning of injury to persons with a safety alert symbol may also include a warning relating to property damage.

### Qualified Personnel

The product/system described in this documentation may be operated only by **personnel qualified** for the specific task in accordance with the relevant documentation, in particular its warning notices and safety instructions. Qualified personnel are those who, based on their training and experience, are capable of identifying risks and avoiding potential hazards when working with these products/systems.

### Proper use of Siemens products

Note the following:

<b>⚠ WARNING</b>
Siemens products may only be used for the applications described in the catalog and in the relevant technical documentation. If products and components from other manufacturers are used, these must be recommended or approved by Siemens. Proper transport, storage, installation, assembly, commissioning, operation and maintenance are required to ensure that the products operate safely and without any problems. The permissible ambient conditions must be complied with. The information in the relevant documentation must be observed.

### Trademarks

All names identified by ® are registered trademarks of Siemens AG. The remaining trademarks in this publication may be trademarks whose use by third parties for their own purposes could violate the rights of the owner.

### Disclaimer of Liability

We have reviewed the contents of this publication to ensure consistency with the hardware and software described. Since variance cannot be precluded entirely, we cannot guarantee full consistency. However, the information in this publication is reviewed regularly and any necessary corrections are included in subsequent editions.

# Preface

These operating instructions contain all the information you need for commissioning and operating the SIMATIC IPC377E.

It is intended both for programming and testing personnel who commission the device and connect it with other units (automation systems, programming devices), as well as for service and maintenance personnel who install add-ons or carry out fault/error analyses.

## Basic knowledge required

A solid background in personal computers and Microsoft operating systems is required to understand this manual. General knowledge in the field automation control engineering is recommended.

## Scope of validity of this documentation

These operating instructions are valid for all versions of the SIMATIC IPC377E.

## Scope of this documentation

The documentation for SIMATIC IPC377E consists of:

- Product information, e.g. "Important notes on your device"
- Quick Install Guide SIMATIC IPC377E
- SIMATIC IPC377E operating instructions in English and Chinese

The PDF version of the documentation is supplied with the device on the "Documentation and Drivers" CD/DVD.

## Conventions

The terms "PC" or "device" are used in place of the product name SIMATIC IPC377E in these operating instructions.

In these operating instructions, "Windows 7" is used as an abbreviation for "Windows 7 Ultimate".

## History

The following earlier release versions of these operating instructions have been published:

<b>Edition</b>	<b>Comment</b>
08/2017	First edition
11/2017	Operating system information has been replaced by references to separate operating system documents.
07/2018	Amendment to certification part.
06/2019	Update the Advanced menu for BIOS description.

# Table of contents

	<b>Preface .....</b>	<b>3</b>
<b>1</b>	<b>Overview.....</b>	<b>8</b>
1.1	Product description .....	8
1.2	Structure of the devices .....	9
1.2.1	Views of the basic device .....	9
1.2.2	Interfaces of the basic device .....	10
1.2.3	Status displays.....	11
<b>2</b>	<b>Safety instructions.....</b>	<b>12</b>
2.1	Security information .....	12
2.2	General safety instructions .....	12
2.3	Notes on usage.....	15
<b>3</b>	<b>Installing and connecting the device .....</b>	<b>17</b>
3.1	Preparing for installation .....	17
3.1.1	Checking the delivery package .....	17
3.1.2	Identification data of the device .....	18
3.1.3	Permitted mounting positions .....	20
3.1.4	Preparing the mounting cutout.....	21
3.2	Installing the device .....	23
3.2.1	Installation guidelines.....	23
3.2.2	Secure with mounting clips .....	24
3.2.3	Fastening a device using a VESA adapter .....	27
3.3	Connecting the device .....	29
3.3.1	Notes on connecting .....	29
3.3.2	Connecting the function earth.....	30
3.3.3	Connecting the power supply .....	31
<b>4</b>	<b>Commissioning the device and device functions.....</b>	<b>34</b>
4.1	General information on commissioning .....	34
4.2	Initial commissioning.....	34
4.3	Switching off the device .....	35
4.4	Windows Security Center .....	37
<b>5</b>	<b>Operating the device.....</b>	<b>38</b>
5.1	Operator input options .....	39
5.2	IPC calibration function.....	39
5.3	Operating the touch screen .....	40
<b>6</b>	<b>Expanding and assigning parameters to the device .....</b>	<b>41</b>

6.1	Open the device .....	41
6.2	Installing the Mini card .....	43
<b>7</b>	<b>Maintaining and repairing the device .....</b>	<b>46</b>
7.1	Maintenance.....	46
7.2	Repair information.....	46
7.3	Cleaning the Device Front .....	47
7.4	Recycling and disposal .....	48
7.5	Installing and removing hardware .....	49
7.5.1	Replacing the backup battery .....	49
7.5.2	Replacing the drive of a basic device .....	50
7.6	Installing the software .....	51
7.6.1	Installing the drivers .....	52
<b>8</b>	<b>Technical specifications .....</b>	<b>56</b>
8.1	Certificates and approvals .....	56
8.2	Directives and declarations.....	59
8.2.1	Electromagnetic compatibility for industrial environments .....	59
8.2.2	ESD guideline .....	59
8.3	Dimension drawings.....	62
8.3.1	Dimension drawing 12" device.....	62
8.3.2	Dimension drawing 15" device.....	63
8.3.3	Dimension drawing 19" device.....	64
8.4	Technical data.....	64
8.4.1	General technical specifications .....	64
8.4.2	Environmental conditions.....	67
8.4.3	Power supply.....	68
8.5	Hardware description .....	69
8.5.1	Technical features of the motherboard .....	69
8.5.2	External interfaces .....	69
8.5.2.1	Overview of interfaces .....	69
8.5.2.2	DC in connector .....	70
8.5.2.3	Serial interface .....	70
8.5.2.4	USB 2.0 port.....	71
8.5.2.5	USB 3.0 port.....	71
8.5.2.6	DisplayPort.....	72
8.5.2.7	Ethernet port .....	72
8.5.3	Internal interface .....	73
8.5.3.1	Overview of internal interfaces.....	73
8.5.3.2	Mini PCIe and mSATA interface .....	73
8.5.4	Currently allocated system resources.....	74
8.6	BIOS description .....	75
8.6.1	BIOS getting started.....	75
8.6.2	Main setup.....	76
8.6.3	Advanced setup .....	78
8.6.4	Chipset setup .....	82
8.6.5	Security setup .....	83

8.6.6	Boot Setup .....	85
8.6.7	Save and Exit.....	88
<b>A</b>	<b>Appendix Motherboard.....</b>	<b>90</b>
A.1	Jumpers .....	90
<b>B</b>	<b>Technical Support.....</b>	<b>93</b>
B.1	Service and support.....	93
B.2	Problem solving .....	94
<b>C</b>	<b>Markings and symbols .....</b>	<b>95</b>
C.1	Overview .....	95
C.2	Safety.....	95
C.3	Operator controls .....	95
C.4	Certificates, approvals and markings.....	96
C.5	Interfaces .....	97
<b>D</b>	<b>List of abbreviations .....</b>	<b>98</b>
	<b>Glossary .....</b>	<b>102</b>
	<b>Index.....</b>	<b>110</b>

# Overview

## 1.1 Product description



SIMATIC IPC377E provides high-level industrial functionality.

- Compact design
- Rugged
- Maintenance-free operation possible

SIMATIC IPC377E is available with various operating units that differ with regard to the display size. This display is a color display with a backlit "wide-screen" format TFT color display.

Displays are available for the SIMATIC IPC377E:

- 12" touch
- 15" touch
- 19" touch



## 1.2 Structure of the devices

### 1.2.1 Views of the basic device

#### Front and side view

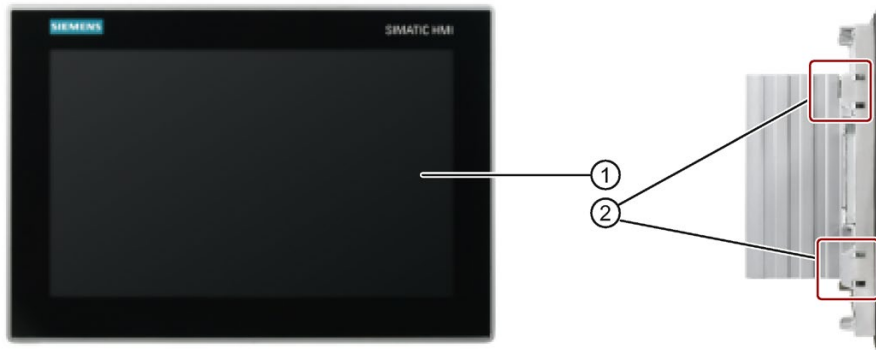

- ① Display/touch screen
- ② Recesses for mounting clips

#### Rear view

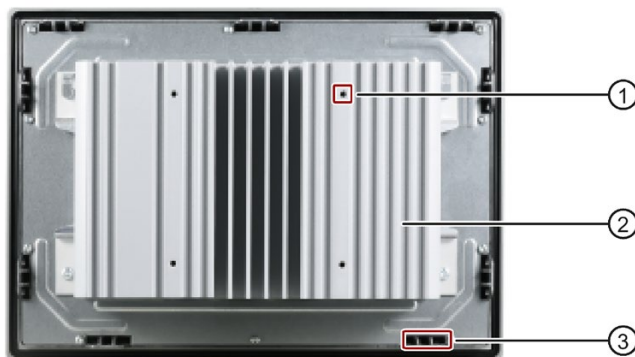

- ① Recesses hole for VESA mounting
- ② Cooling fin
- ③ Recesses for mounting clips

Bottom view

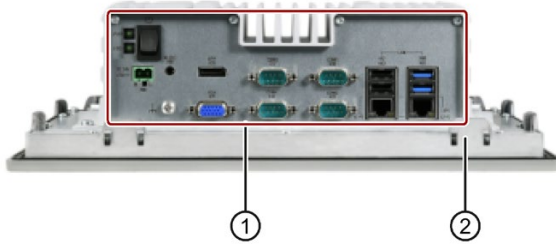

- ① Interfaces and operating elements
- ② Recesses for mounting clips

Top view



- ① Product label

1.2.2 Interfaces of the basic device

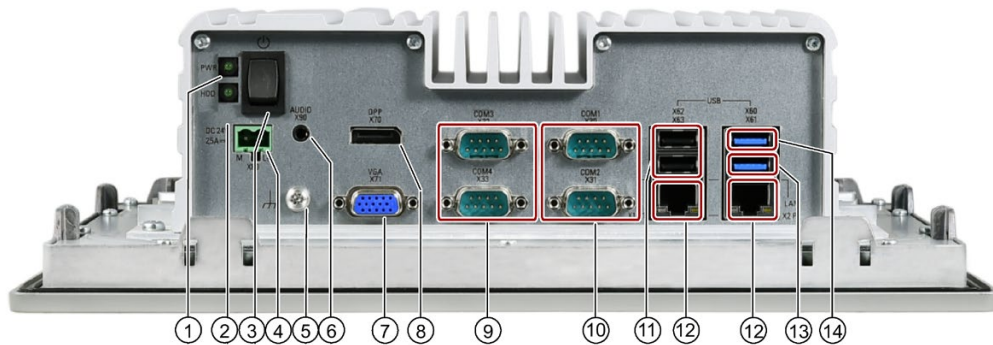

- ① Power status display
- ② HDD status display
- ③ On/off switch.
- ④ Connection for a 24 VDC power supply
- ⑤ Function earth
- ⑥ Connection for analog audio source and speaker
- ⑦ VGA interface

- ⑧ Display Port connection
- ⑨ Serial interface, 9-pin
  - RS-232
- ⑩ Serial interface, 9-pin
  - RS-232
  - RS-422
  - RS-485
- ⑪ USB 2.0, high current
- ⑫ RJ45 Ethernet connection for 10/100/1000 Mbps
- ⑬ USB 3.0 port 2, high current
- ⑭ USB 3.0 port 1, high current

Observe the printing on the rear of the device.

### 1.2.3 Status displays



Display	Meaning	LED	Description
PWR	PC operating status display	Off	Hibernate, switched off or unplugged
		Green	PC is in operation.
		Green flashing	standby
HDD	Display for hard disk access	Off	No accessing
		Green flashing	Accessing data

## Safety instructions

### 2.1 Security information

Siemens provides products and solutions with industrial security functions that support the secure operation of plants, systems, machines and networks.

In order to protect plants, systems, machines and networks against cyber threats, it is necessary to implement – and continuously maintain – a holistic, state-of-the-art industrial security concept. Siemens' products and solutions constitute one element of such a concept.

Customers are responsible for preventing unauthorized access to their plants, systems, machines and networks. Such systems, machines and components should only be connected to an enterprise network or the internet if and to the extent such a connection is necessary and only when appropriate security measures (e.g. firewalls and/or network segmentation) are in place.

For additional information on industrial security measures that may be implemented, please visit (<https://www.siemens.com/industrialsecurity>).

Siemens' products and solutions undergo continuous development to make them more secure. Siemens strongly recommends that product updates are applied as soon as they are available and that the latest product versions are used. Use of product versions that are no longer supported, and failure to apply the latest updates may increase customers' exposure to cyber threats.

To stay informed about product updates, subscribe to the Siemens Industrial Security RSS Feed visit (<https://www.siemens.com/industrialsecurity>).

### 2.2 General safety instructions

 **WARNING**

**Life-threatening voltages are present with an open control cabinet**

When you install the device in a control cabinet, some areas or components in the open control cabinet may be carrying life-threatening voltages.

If you touch these areas or components, you may be killed by electric shock.

Switch off the power supply to the cabinet before opening it.

## System expansions

<b>NOTICE</b>
---------------

<b>Damage through system expansions</b>
---

Device and system expansions may be faulty and can affect the entire machine or plant.
--

The installation of expansions can damage the device, machine or plant. Device and system expansions may violate safety rules and regulations regarding radio interference suppression. If you install or exchange system expansions and damage your device, the warranty becomes void.
---

Note the following for system expansions:

- Only install system expansion devices designed for this device. Contact your technical support team or where you purchased your PC to find out which system expansion devices may safely be installed.
- Observe the information on electromagnetic compatibility (Page 59).

 <b>WARNING</b>
--

<b>Risk of fire</b>
---------------------

For vertical installation in upright format, observe the following:
---

Install the device in an enclosure that meets the requirements of paragraphs 4.6 and 4.7.3 of the standards EN 60950-1:2006 and IEC/UL/EN/DIN-EN 60950-1.
---

<b>NOTICE</b>
---------------

<b>"Open Type" UL61010-2-201</b>
----------------------------------

Note that the device is classified as "Open Type" for use in the area of Industrial Control Equipment (UL61010-2-201). A UL61010-2-201 conform enclosure is therefore a mandatory requirement for approval or operation according to UL61010-2-201.
---

## Battery

 **WARNING**

**Risk of explosion and release of harmful substances**

Improper handling of lithium batteries can result in an explosion of the batteries.

Explosion of the batteries and the released pollutants can cause severe physical injury. Worn batteries jeopardize the function of the device.

Note the following when handling lithium batteries:

- Replace used batteries in good time; see the section "Replacing the backup battery (Page 49)" in the operating instructions.
- Replace the lithium battery only with an identical battery or types recommended by the manufacturer (type: CR2032).
- For any requirements on product maintenance, contact Siemens Technical support. (Page 93)
- Do not throw lithium batteries into fire, do not solder on the cell body, do not recharge, do not open, do not short-circuit, do not reverse polarity, do not heat above 100°C, and protect from direct sunlight, moisture and condensation.

## Strong high-frequency radiation

**NOTICE**

**Observe immunity to RF radiation**

The device has an increased immunity to RF radiation according to the specifications on electromagnetic compatibility in the technical specifications.

Radiation exposure in excess of the specified immunity limits can impair device functions, result in malfunctions and therefore injuries or damages.

Read the information on immunity to RF radiation in the technical specifications.

## ESD Guideline



Electrostatic sensitive devices can be labeled with an appropriate symbol.

**NOTICE**

**Electrostatic sensitive devices (ESD)**

When you touch electrostatic sensitive components, you can destroy them through voltages that are far below the human perception threshold.

If you work with components that can be destroyed by electrostatic discharge, observe the ESD Guideline (Page 59).

## 2.3 Notes on usage

 <b>WARNING</b>
<b>Risks associated with the unprotected machine or plant</b>
According to the results of a risk analysis, certain hazard potentials associated with the unprotected machine exist. These hazards could lead to personal injury.
Avoid such hazards by taking the following precautions in accordance with the risk analysis:
<ul style="list-style-type: none"><li>• Installation of additional safety equipment on the machine or plant. In particular, the programming, parameter assignment and wiring of the inserted I/O must be executed in accordance with the safety performance identified by the necessary risk analysis (SIL, PL or Cat.).</li><li>• Use as intended must be validated for the device by means of a function test on the plant. These tests help you to identify programming, parameter assignment and wiring errors.</li><li>• Documentation of the test results that you can enter in the relevant safety verification documents, if necessary.</li></ul>

## Environment

<b>NOTICE</b>
<b>Ambient conditions and chemical resistance</b>
Unsuitable environmental conditions have a negative impact on device operation. Chemical substances such as cleaners or fuels may alter the color, shape and structure of the device surface, for example, the front panel.
The device may be damaged, possibly resulting in malfunctions.
For this reason, please observe the following precautions:
<ul style="list-style-type: none"><li>• Always operate the device in closed rooms. All warranties shall be void in the case of noncompliance.</li><li>• Operate the device only in accordance with the ambient conditions specified in the technical specifications.</li><li>• Protect the device against dust, moisture and heat.</li><li>• Do not expose the device to direct sunlight or to other strong sources of light.</li><li>• Without additional safety measures, such as a supply of clean air, the device may not be used in locations with harsh operating conditions caused by acidic vapors or gases.</li><li>• Always use suitable cleaning agents. Read the information about chemical resistance in the Internet, see "SIMATIC IPC after-sales information system (<a href="http://www.siemens.com/asis">http://www.siemens.com/asis</a>)".</li></ul>

**Note**

**Use in an industrial environment without additional protective measures**

The device has been designed for use in a normal industrial environment in accordance with IEC 60721-3-3 (pollutant class 3C2 for chemical influences, 3S2 for sand and dust).

---

**TFT displays**

<b>NOTICE</b>
<b>Burn-in effect and backlighting</b>
<p>A permanent picture with bright screen objects leads to a burn-in effect. The longer the same screen contents are displayed, the longer it will take for the burn-in effect to disappear. Screensavers (for example, "starfield simulation") for the backlit active black mode reduce the burn-in effect. The brightness of the backlighting deteriorates over the course of the screen's life cycle.</p> <p>The service life of the screen and backlighting is extended by the following measures:</p> <ul style="list-style-type: none"><li>• Switch on the screensaver. The backlight brightness is reduced while the screensaver is active.</li><li>• You should also reduce the backlighting.</li><li>• Observe the backlighting operating time.</li></ul>

**Defective pixels in the display**

At present, the manufacturing process of modern displays does not guarantee that all pixels of the display will be perfect. A small number of defective pixels in the display is therefore unavoidable. This does not present a functional problem as long as the defective pixels are not bunched in one location.

Additional information is available in the section "Technical specifications (Page 56)".



# Installing and connecting the device

## 3.1 Preparing for installation

### 3.1.1 Checking the delivery package

#### Procedure

1. When accepting a delivery, please check the packaging for visible transport damage.
2. If any transport damage is present at the time of delivery, lodge a complaint at the shipping company in charge. Have the shipper confirm the transport damage immediately.
3. Unpack the device at its installation location.
4. Keep the original packaging in case you have to transport the unit again.

---

#### Note

##### Damage to the device during transport and storage

If a device is transported or stored without packaging, shocks, vibrations, pressure and moisture may impact the unprotected unit. A damaged packaging indicates that ambient conditions have already had a massive impact on the device.

The device may be damaged.

Do not dispose of the original packaging. Pack the device during transportation and storage.

---

5. Check the contents of the packaging and any accessories you may have ordered for completeness and damage.
6. If the contents of the packaging are incomplete, damaged or do not match your order, inform the responsible delivery service immediately.

 <b>WARNING</b>
--

<b>Electric shock and fire hazard due to damaged device</b>
---

A damaged device can be under hazardous voltage and trigger a fire in the machine or plant. A damaged device has unpredictable properties and states.
---

Death or serious injury could occur.
--------------------------------------

Make sure that the damaged device is not inadvertently installed and put into operation. Label the damaged device and keep it locked away. Send off the device for immediate repair.
--

<b>NOTICE</b>
<b>Damage from condensation</b>
If the device is subjected to low temperatures or extreme fluctuations in temperature during transportation, for example in cold weather, moisture could build up on or inside the device.
Moisture causes a short circuit in electrical circuits and damages the device.
In order to prevent damage to the device, proceed as follows:
<ul style="list-style-type: none"><li>• Store the device in a dry place.</li><li>• Bring the device to room temperature before starting it up.</li><li>• Do not expose the device to direct heat radiation from a heating device.</li><li>• If condensation develops, wait approximately 12 hours or until the device is completely dry before switching it on.</li></ul>

7. Please keep the enclosed documentation in a safe place. It belongs to the device. You need the documentation when you commission the device for the first time.
8. Write down the identification data of the device.

### 3.1.2 Identification data of the device

The device can be clearly identified with the help of this identification data in case of repairs or theft.







Enter the identification data in the following table:

Order number	6AV...
Serial number	S V
Product version	FS
Windows "Product Key"	
Ethernet address 1 (MAC)	
Ethernet address 2 (MAC)	

You can find this information on the product label and COA label. The product label is located on the back of the unit. The COA label is only available with pre-installed Windows operating systems and is affixed to the rear of the device.

## Procedure

1. Get the information of order number, serial number, production version (FS), and Ethernet addresses from the product label. Below is an example of a product label.

<b>SIEMENS</b>	
SIMATIC IPC377E  (1P) 6AV4022-0AA21-0BA1  (S) V-FN952598 FS: 01 <b>SERVICE &amp; SUPPORT:</b> www.siemens.com/asis	500 GB HDD 4 GB RAM 12" Touch Celeron N3160 Cabinet / VESA Mount Windows 7 Ultimate 64 Bit MAC-ADDRESSES: ETHERNET LAN: 00:1B:1B:C2:38:A9 ETHERNET LAN: 00:1B:1B:C2:38:DE <small>THIS DEVICE COMPLIES WITH PART 15 OF THE FCC RULES. OPERATION IS SUBJECT TO THE FOLLOWING TWO CONDITIONS: (1) THIS DEVICE MAY NOT CAUSE HARMFUL INTERFERENCE, AND (2) THIS DEVICE MUST ACCEPT ANY INTERFERENCE RECEIVED, INCLUDING INTERFERENCE THAT MAY CAUSE UNDESIRABLE OPERATION. CAN ICES-3(A)/NMB-3(A)</small>
   	
Siemens AG, Gleiwitzer Str. 555, DE-90475 Nuremberg Made in China	

### Note

#### Replacement device without storage media

When you order a replacement device, remove all the storage media from your device, for example HDD. Insert the storage media in the replacement device.

2. Take down the Windows "Product Key" from the COA label.

## Example of a COA label

Microsoft Windows "Product Key" on the "Certificate Of Authenticity" (COA):  
 The COA label is only attached to the rear of the device containing a preinstalled and activated Windows operating system.

- COA label of a device with Windows operating system

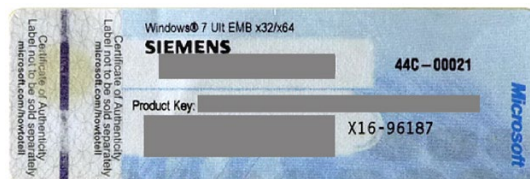

### 3.1.3 Permitted mounting positions

The device may be mounted in the following positions:

- Standard position: Vertical installation in horizontal format

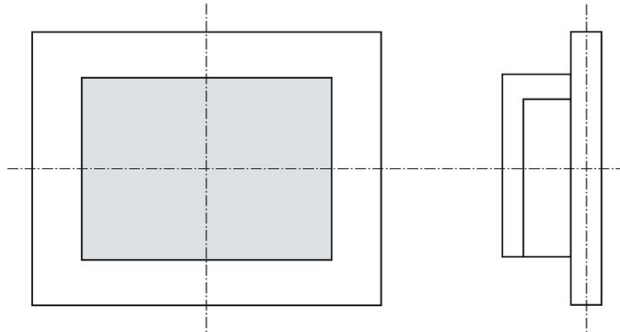

For vertical installation in horizontal format, the following ambient temperatures are permitted:

Maximum ambient temperature at the device	Comment
45 °C	The device enclosure fulfills the requirement of a fire protection enclosure.

- Inclined installation in horizontal format with a vertical inclination of maximum  $\pm 45^\circ$

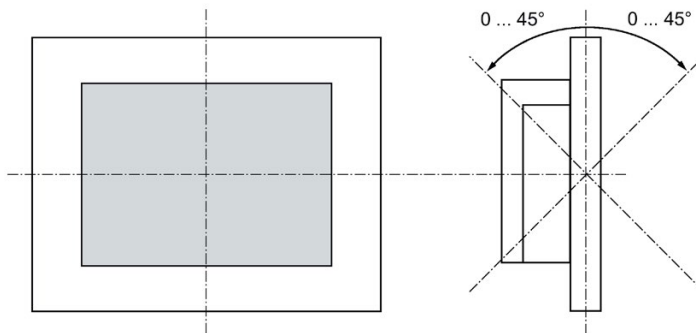

For inclined installation in horizontal format, the following ambient temperatures are permitted:

Maximum ambient temperature at the device	Comment
45 °C	The device enclosure fulfills the requirement of a fire protection enclosure.

- Vertical installation in upright format, display turned through  $\pm 90^\circ$  compared with the standard position

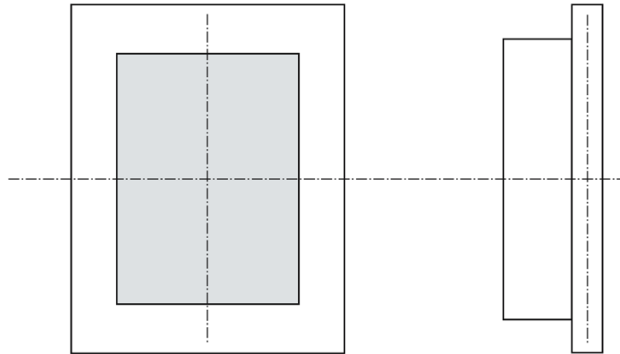

For vertical installation in upright format, the following ambient temperatures are permitted:

Maximum ambient temperature at the device	Comment
45 °C	The device must be installed in a fire protection enclosure (see "General safety instructions (Page 12)").

### 3.1.4 Preparing the mounting cutout

#### Note

#### Stability of the mounting cutout

The material in the area of the mounting cutout must provide sufficient strength to guarantee the enduring and safe mounting of the device.

To achieve the degrees of protection described below, it must be ensured that deformation of the material cannot occur due to the force of the mounting clips or operation of the device.

#### Degrees of protection

The degrees of protection of the device can only be guaranteed if the following requirements are met:

- In order to achieve IP65 protection degree or NEMA type4X/type12, the material thickness for the mounting cutout should be: 2 mm to 6 mm
- Permissible deviation from plane at the mounting cutout:  $\leq 0.5$  mm  
This condition must be fulfilled for the mounted device.
- Permissible surface roughness in the area of the seal:  $\leq 120$   $\mu\text{m}$  ( $R_z 120$ )

### Dimensions of the mounting cutout

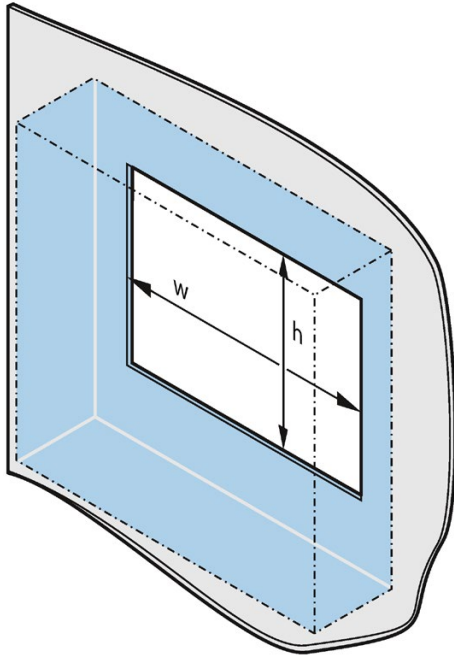

The following table shows the dimensions of the required mounting cutout:

Mounting cutout	Device		
	12 Inch	15 Inch	19 Inch
Width w *	302 <sup>+1</sup> mm	388.4 <sup>+1</sup> mm	455 <sup>+1</sup> mm
Height h *	208 <sup>+1</sup> mm	240.5 <sup>+1</sup> mm	279.2 <sup>+1</sup> mm

\* Width and height should be reversed accordingly when mounting in vertical format.

## 3.2 Installing the device

### 3.2.1 Installation guidelines

The installer of the plant is responsible for proper installation of the device.

#### WARNING

##### **Dangerous voltage in control cabinet**

A high voltage may be present in the switchgear cabinet and could cause a dangerous electric shock.

It may result in death or serious physical injury.

Isolate the power supply to the control cabinet before opening it. Ensure that the power to the control cabinet cannot be turned on accidentally.

#### NOTICE

##### **Risk of fire**

If you install the device in an unapproved mounting position or if you do not observe the ambient conditions, the device can overheat.

Overheating can cause a fire. Proper functioning of the device is no longer guaranteed.

Before you install the device, note the following general installation information.

#### **Note**

In the standard installation position, the device meets the requirements for fire protection enclosures in accordance with EN 60950-1. It can therefore be installed without an additional fire protection covering.

#### **Note**

If the equipment is used in manner not specified by the manufacture, the protection provided by the equipment may be impaired.

- Install the device only in one of the permitted mounting positions, and it is approved for operation indoor only.
- For installation in a control cabinet, observe the applicable country-specific regulations.
- Ensure that the device is classified as "Open Type" when using it in the area of Industrial Control Equipment (UL61010-2-201). A UL61010-2-201 conform enclosure is therefore a mandatory requirement for approval or operation according to UL61010-2-201.
- Provide adequate volume in the control cabinet for air circulation and heat transport. Keep at least 5 cm distance between the device and control cabinet.

3.2 Installing the device

- Equip the control cabinet with struts for stabilizing the mounting cut-out. Install struts where necessary.
- All the external circuit of the device should be SELV circuit.

IP65 degree of protection

 <b>WARNING</b>
<b>Risk of electric shock</b> The specified degree of protection cannot be guaranteed if the device is not correctly installed. Moisture or water could leak in and cause electric shock or destroy the plant. The degree of protection IP65 is ensured for the front of the device under the following conditions: <ul style="list-style-type: none"><li>• The mounting cutout was prepared based on the correct dimensions; see chapter "Preparing the mounting cutout (Page 21)".</li><li>• The device was secured with the supplied mounting clamps or with clamps which can be optionally ordered.</li><li>• The mounting seal is undamaged.</li></ul>

3.2.2 Secure with mounting clips

Positions of the mounting clips

To achieve the degree of protection for the device, the positions for the mounting clips shown below must be adhered to.

The positions of the mounting clips are marked by stamps on the cutouts. Fit the mounting clips in all the stamped cutouts.

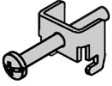
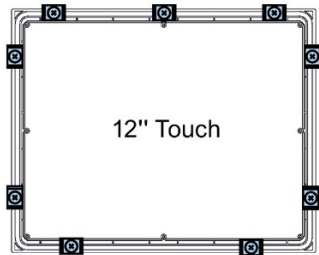
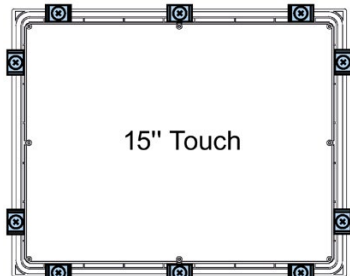
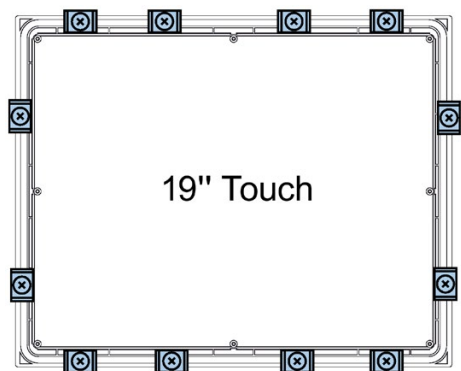

The following table shows the type, number, and position of the mounting clips needed for the respective devices.

Device	Mounting clips		
	Type	Quantity	Position on the device
12" display		9	 <p>12" Touch</p>
15" display		10	 <p>15" Touch</p>
19" display		12	 <p>19" Touch</p>

**Requirement**

- All packaging components and protective films should be removed from the device.
- To install the panel, you need the mounting clips from the accessories kit.

Procedure

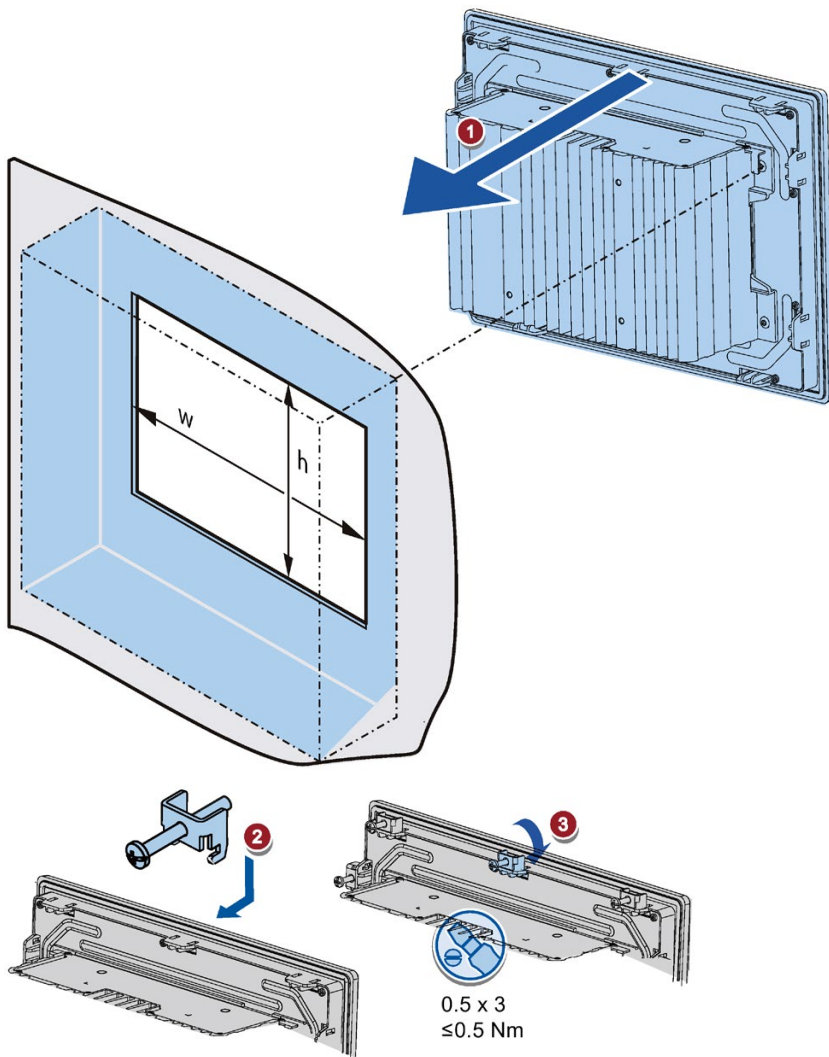

- 1** Insert the panel device into the mounting cutout from the front.
- 2** Insert a mounting clip into the cutout provided on the device.
- 3** Tighten the threaded pin to secure the mounting clip. The threaded pins have a maximum tightening torque of 0.5 Nm.
- 4** Repeat steps 2 and 3 for all mounting clips.
- 5** Check the fit of the mounting seal.

Result

The device is mounted and the relevant degree of protection is ensured at the front.

### 3.2.3 Fastening a device using a VESA adapter

You can also fasten the SIMATIC IPC377E using a VESA (Video Electronics Standards Association) adapter.

Different models of VESA adapters are offered by third-party manufacturers.

---

#### Note

To meet UL requirements, the type of VESA adapter must be an UL1678 listed device.

When fastening the VESA adapter, shock or vibration is not permitted.

---

<b>NOTICE</b>
<b>Degree of protection for overall device</b>
If you are fastening the device via a VESA adapter, degree of protection of the device will be lost. Spray and water jets as well as penetrating substances can then damage the device.

<b>NOTICE</b>
<b>Dimensioning of the VESA adapter</b>
When selecting the VESA adapter, make sure that it is designed for at least four times the weight of the device.

 <b>WARNING</b>
<b>The device must be mounted securely</b>
Inadequately dimensioned fastening material may cause the device to fall down. Serious bodily injury may result.
Make sure that fasteners are adequately dimensioned during installation of the device. Make sure to consider the weight of the device and the forces acting on the device when dimensioning the fasteners. This applies in particular to dynamic load of the device. All fasteners including mounting surfaces, support arm systems, and fastening elements such as screws must be able to carry at least four times the weight of the device.
Observe any further statutory specifications applying at the location of use of the device and further applicable regulations with regard to the fastening of the device.

IPC377E is VESA compliant and can be mounted on all kinds of applications utilizing the standard VESA100 mounting interfaces.

Fasten the VESA adapter with the designated screws (M4).

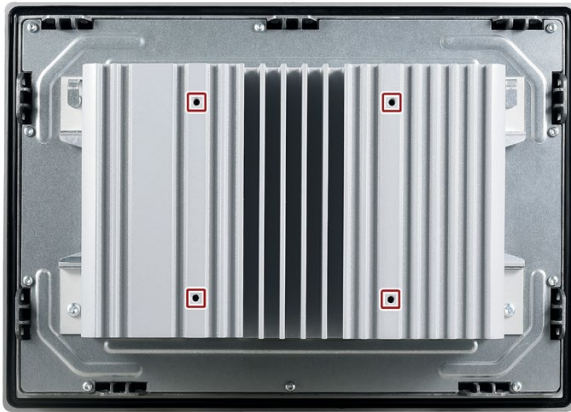

## Requirements

- All packaging components and protective films have been removed.
- VESA support application (for example, an arm or a stand) from a third party

## Procedure

---

### Note

Make sure your support application is VESA100 compliant. Otherwise, you cannot use it to support IPC377E.

---

### Note

#### Observe the torques

If you use **too much** torque to tighten the screws of the screws for fastening the device to a support arm or stand, the support arm may be damaged. If you tighten the screws with a torque that is **too low**, the device is not sealed.

Tighten the screws with the following torques, which may not be exceeded.

Adhere to the torque specifications of the third-party vendors:

1.5 Nm for connecting the device and the VESA mounting interface.

---

Secure the device to the mounting interface with four M4 x 10 screws.

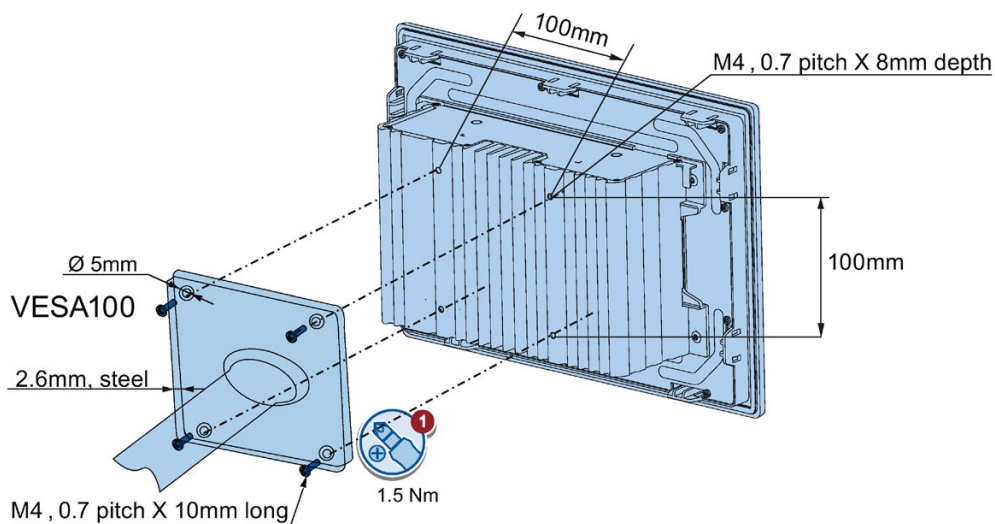

## 3.3 Connecting the device

### 3.3.1 Notes on connecting

#### **⚠ WARNING**

##### **Risk of fire and electric shock**

The on/off switch does not isolate the device from the power supply. Risk of electric shock if the device is opened incorrectly or defective. There is also a risk of fire if the device or connecting lines are damaged. Death or serious bodily injury can result.

You should therefore protect the device as follows:

- Always pull out the power plug when you are not using the device or if the device is defective. The power plug must be freely accessible.
- Use a central power isolating switch for cabinet installation.

 <b>WARNING</b>
<b>Risk of lightning strikes</b> A lightning flash may enter the mains cables and data transmission cables and jump to a person. Death, serious injury and burns can be caused by lightning. Take the following precautions: <ul style="list-style-type: none"><li>• Disconnect the device from the power supply in good time when a thunderstorm is approaching.</li><li>• Do not touch mains cables and data transmission cables during a thunderstorm.</li><li>• Keep a sufficient distance from electric cables, distributors, systems, etc.</li></ul>

### 3.3.2 Connecting the function earth

A connected function earth discharges hazardous electric charges from the metal enclosure. The current flowing through the function earth when such a fault occurs triggers an upstream protective device that disconnects the machine from the power supply.

The function earth also improves the discharge of interference generated by external power cables, signal cables or cables for I/O modules to ground.

The connection for the function earth is labeled with the following symbol:



---

#### Note

The function earth cannot connect hazard live parts.

---

 <b>WARNING</b>
<b>Electric shock and risk of fire</b> High voltage may be present in a defective device, which can cause fire or an electric shock if touched. Death and serious bodily injury can result. <ul style="list-style-type: none"><li>• Connect the device to the function earth before you put it into operation.</li><li>• The FE terminal on the device must be connected to the function conductor of the control cabinet or system in which the device is installed.</li><li>• Never operate the device without function earth.</li><li>• If a device is defective, remove it from operation without delay and label it accordingly.</li></ul>

**Requirement**

- PH2 screwdriver
- Cable lug for M4
- Function earth with a minimum cross-section of 2.5 mm<sup>2</sup> copper cable

**Procedure**

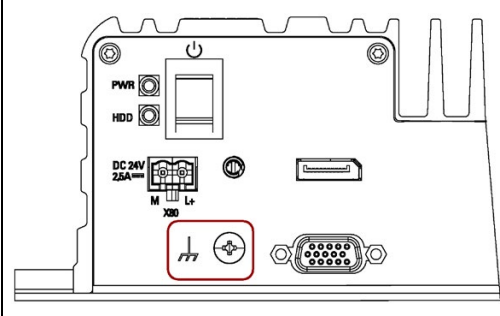
	<b>1</b>	Clamp the cable lug onto the function earth.
	<b>2</b>	Firmly attach the cable lug to the function earth connection on the device using the M4 thread (see part labeled).
	<b>3</b>	Connect the function earth to the function earth connection of the cabinet or the plant in which the device is installed.

**3.3.3 Connecting the power supply****Note**

The device should only be connected to a 24 VDC power supply which meets the requirements of safe extra low voltage (SELV) according to IEC/EN/DIN EN/UL 60950-1.

The power supply must meet the requirement NEC Class 2 or LPS according to the IEC/EN/DIN EN/UL 60950-1.

**Note**

The 24 V DC power supply must be adapted to the input data of the device (see Technical specifications (Page 56)).

**Requirement**

- The function earth is connected.
- You are using the supplied terminal.
- A two-core cable with a cable cross-section of 0.75 mm<sup>2</sup> to 2.5 mm<sup>2</sup> for the 24 VDC connection.
- A slotted screwdriver with approx. 3 mm blade.

### Procedure

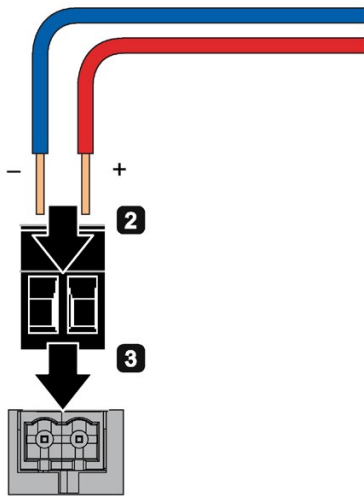

- 1 Switch off the 24 VDC power supply.
- 2 Connect the wires of the power supply.

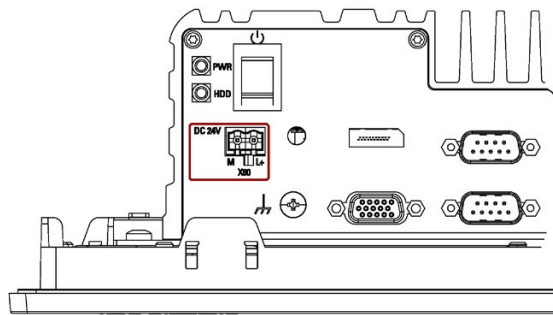

- 3 Connect the connection terminal at the marked position.

The following options are available for integrating the device in existing or planned system environments and networks.

### Ethernet

You can use the integrated Ethernet interfaces (10/100/1000 Mbps) for communication and data exchange with automation devices, e.g. SIMATIC S7.

You need a suitable software to use this functionality: STEP 7, WinCC, SIMATIC NET.



## **Industrial Ethernet**

You can establish a network between the device and other computers via Industrial Ethernet. The on-board LAN interfaces are twisted-pair TP interfaces that support data transmission rates of 10/100/1000 Mbps.

---

### **Note**

You need a category 6 Ethernet cable for operation at 1000 Mbps.

---

## **PROFINET**

PROFINET RT can be operated via:

- Standard Ethernet interfaces
- Implemented PROFINET Driver and valid runtime license (for further information, refer to PROFINET Driver (<http://w3.siemens.com/mcms/distributed-io/en/profinet/profinet-driver/pages/default.aspx>) )

## **SIMATIC NET**

Use this software package to create, operate and configure an innovative network for Field & Control level. Information on this can be found on the SIMATIC NET Manual Collection CD. The software package and the documentation are not included in the product package.

## **Additional information**

You can find additional information on the Internet at: Technical support (<https://support.industry.siemens.com/cs/?lc=en-WW>)

# Commissioning the device and device functions

## 4.1 General information on commissioning

---

**Note****Windows Embedded Standard 7**

Read the EWF and FBWF information

Two configurable write filters (Enhanced Write Filter and File Based Write Filter) are provided with Windows Embedded Standard. Read the EWF/FBWF information if you activate and use them, otherwise you may experience data loss.

---

**Requirement**

- The device is connected to the power supply.
- The function earth is connected.
- The connection cables are plugged in correctly.
- The following hardware is available for initial commissioning:
  - One USB keyboard
  - One USB mouse

## 4.2 Initial commissioning

Following the initial switch-on, the operating system pre-installed on the device is set up automatically on the device.

**NOTICE****Faulty installation**

If you change the default values in the BIOS setup or if you turn off the device during installation, you disrupt the installation and the operating system is not installed correctly. The operating safety of the device and the plant is at risk.

Do not switch off the device during the entire installation process. Do not change the default values in the BIOS setup.

**Note**

If you install Windows 7 not by our restore or recovery DVD, you need to do the following two steps:

- Get the xHCI (USB) driver from the Documentation and Drivers DVD.
- Refer to "Walkthrough: Create a Windows RE Image ([https://technet.microsoft.com/en-us/library/dd744525\(v=ws.10\).aspx](https://technet.microsoft.com/en-us/library/dd744525(v=ws.10).aspx))" to mount USB driver into the Windows Recovery Environment(RE).

If you install Windows 8 or Windows 10, you don't need to do the above two steps.

---

**Procedure - Switching on the device**

1. Press the on/off switch.

The module carries out a self-test. During the self-test, the following message appears:

```
Press ESC for boot options
```

2. Wait for the message to disappear.
3. Follow the instructions on the screen.
4. Make the region and language settings.

If you want your system language to be international, select English. For information on changing the region and language settings at a later point in time, refer to the section Installing the software (Page 51).

---

**Note**

Once the operating system has been set up, the device may restart.

---

**Result**

The interface of the operating system is displayed every time you turn on the device and after the startup routine.

## 4.3 Switching off the device

**Shutting down the operating system**

**For Windows operating systems:**

- Select "Start" > "Shut down"
- or
- Briefly press the on/off switch (unless otherwise configured in the power options). Information on the position of the button is available in the section "Interfaces of the basic device (Page 10)".

4.3 Switching off the device

**For non-Windows operating systems:**

- Briefly press the on/off switch.

The operating system is shut down. The "POWER" LED goes out. The device is switched off but not fully disconnected from the mains voltage.

**Fully disconnecting the device from mains voltage**

 <b>WARNING</b>
<b>Risk of fire and electric shock</b>
The on/off switch do not fully disconnect the device from the mains. If the device is switched off with the on/off switch, there remains a risk of electric shock and fire hazard, for example, if the device or connection cables are damaged or if the device is used improperly.
Always fully disconnect the device from the mains voltage as described below before performing work on the device or when the device will not be used over an extended period of time.

**If the device was not mounted in a control cabinet:**

- Shut down the operating system and pull the power plug on the rear of the device.

**If the device was mounted in a control cabinet:**

- Shut down the operating system and switch the AC circuit breaker to "Off".

The device is switched off and fully disconnected from the mains voltage. No trickle current is flowing.

**Hardware reset**

You can perform a hardware reset to switch off the device when the operating system no longer responds to input from the keyboard or mouse. The operating system is not safely shut down in this case.

<b>NOTICE</b>
<b>Risk of data loss</b>
The device is restarted in the case of a hardware reset. Data in the main memory can be deleted. Data on the drive may be lost. The device may be damaged.
Perform a hardware reset only in the case of an emergency.

**For all operating systems:**

- Press the on/off switch for more than four seconds.

## 4.4 Windows Security Center

### Warning from the Windows Security Center

A warning from the Windows Security Center is displayed the first time you switch on your device. The Security Center checks the status of the device in regard to the three important security aspects listed below. If a problem is detected (an outdated antivirus program, for example), the Security Center issues a warning and makes recommendations on how you can better protect the device.

- **Firewall:** The Windows Firewall adds protection to the device by blocking network or Internet access to the device by unauthorized users. Windows checks if the device is protected by a software firewall.  
The firewall is enabled by default in the delivery state.
- **Antivirus software:** Antivirus programs add protection to the device by searching for and eliminating viruses and other security threats. Windows checks if a full-range, up-to-date antivirus program is running on the device.  
No antivirus software is installed in the delivery state.
- **Automatic updates:** Using the Automatic Update feature allows Windows to regularly search for the latest critical updates for the device and to install them automatically. This feature is disabled in the delivery state.
- **Real-time protection (Windows 7 only):** Windows Defender displays warnings if spyware or possibly unwanted software is installed or executed on the computer. You will also receive a warning if programs attempt to modify important Windows settings.

Configure the Security Center according to your requirements.

## Operating the device

The device variants differ with regard to their dimensions and display size.

The example in the following figure shows the front view of the 12" touchscreen variant.



① Display with touchscreen

## 5.1 Operator input options

Depending the connected I/O devices, the following operator input options are available:

- Touch screen

 <b>CAUTION</b>
<b>Unintentional actions with touch screen operation</b> If you touch the touch screen while system-internal processes are running, unintended reactions of the device may be triggered. Do not touch the screen in the following situations: <ul style="list-style-type: none"><li>• During the boot process</li><li>• When plugging or unplugging USB components</li><li>• While Scandisk is running</li><li>• During a BIOS update</li></ul>
<b>NOTICE</b>
<b>Damage to the touch screen</b> Hitting the touch screen with hard objects may damage it and can result in a total failure of the touch screen. Only touch the touch screen with your fingers or a suitable touch stylus.

- Screen keyboard for touch device
- External keyboard, connected via USB
- External mouse, connected via USB

## 5.2 IPC calibration function

### Software introduction

After install the Touch driver in Installing the drivers (Page 52), you will see the HIDEGalax Touch software is installed in IPC automatically.

The HIDEGalax Touch software contains the following features:

- Advanced touch features
- Calibrating

This calibration function has three calibration methods: 4 points calibration, 9 points calibration and 25 points calibration. You can select any of them for calibrating as your request.

## 5.3 Operating the touch screen

Application-specific user interface elements, for example buttons, are shown on the display. Tapping a button with your finger activates the function assigned to the button.

 **WARNING**

**Incorrect operation of the touch screen**

Incorrect operations at the touch screen cannot be excluded. Such actions may lead to personal injury or damage to the machine or plant.

Take the following precautions:

- Never use the touch screen to control safety-related functions.
- Use a suitable touch pen to operate the touch screen.
- Calibrate the touch screen regularly.
- Cut off the power supply of the device for cleaning and maintenance.

**The following types of pressure are permissible:**

- Using a plastic pen with a 1 mm radius at the point: 25 g.
- Using a silicone finger with a diameter of 1.6 cm: 50 g.

---

**Note**

Only touch one point on the touch screen and not several points at one time, as this may trigger unintended reactions.

---



## Expanding and assigning parameters to the device

### 6.1 Open the device

#### Requirement

- The device is disconnected from the power supply.
- All cables have been disconnected from the device.
- The device has been removed from the control cabinet.
- A T10 screwdriver and a T20 screwdriver.

#### Procedure – Opening the device



---

##### Note

The drive is located on the underside of the device cover.

- Carefully open the device.
  - You cannot set the device cover down because of the connecting cable of the drive.
  - You first have to pull out the connection plug in order to completely remove the device cover.
-

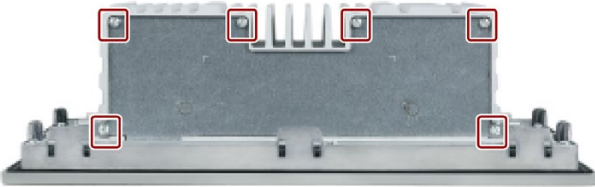
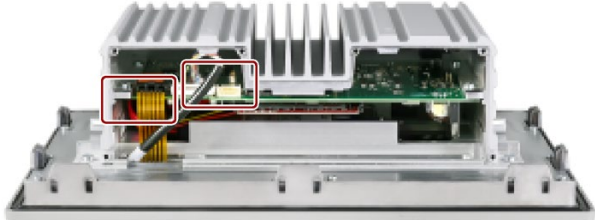
6.1 Open the device

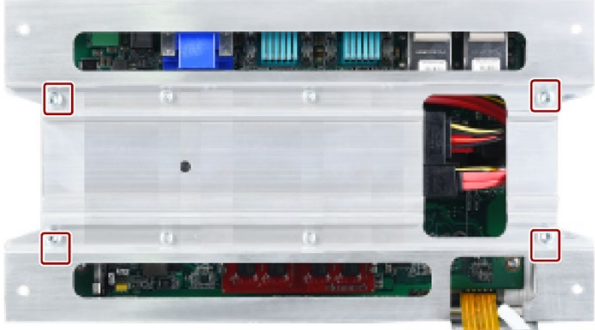
	<p><b>1</b> Remove the marked screws on the interface shield.</p>
	<p><b>2</b> Remove the Interface shield carefully.</p> <p><b>3</b> Unplug the marked cable connectors.  <b>Notice:</b></p> <ul style="list-style-type: none"> <li>• For 12" device, only has two cable connectors: LVDS connector and touch connector;</li> <li>• For 15" and 19" devices, there are three cable connectors: LVDS connector, power connector and touch connector.</li> </ul>
	<p><b>4</b> Remove the marked screws on the back of the panel PC.</p>
	<p><b>5</b> Hold the main machine and turn it back.</p> <p><b>6</b> Remove the marked screws.</p>

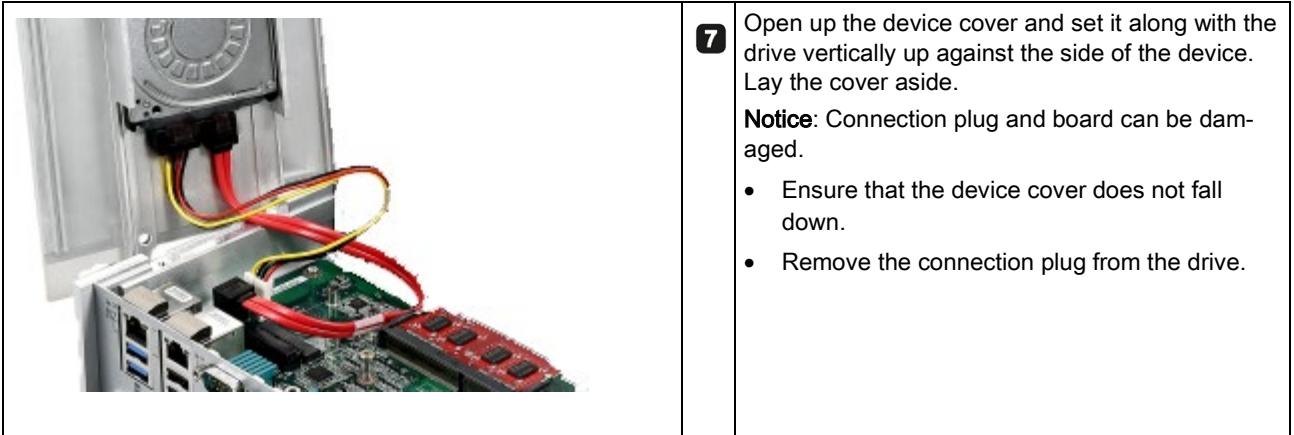

### Procedure - closing the device.

Close the device in reverse order.

## 6.2 Installing the Mini card

This device supports the below expansion cards:

- a half-size mini card: you can install a half-size mini PCIe card into this slot.
- a full-size mini card: you can install a mSATA card or a mini card with USB2.0 interface in this slot

---

### Note

#### Power consumption

If the power consumption of the Mini cards are too high, the device will be damaged.

Ensure that the power consumption amounts to a maximum of 1 W.

#### Ambient temperature

The temperature inside the IPC can be up to 25 °C above the maximum permissible ambient temperature of the device.

Make sure that the maximum permissible ambient temperature of the Mini cards are specified accordingly.

---

### Note

If you want to use both of the two slots, insert the half-size mini card first.

---

### Requirement

- The device is opened.

### Install a half-size mini card

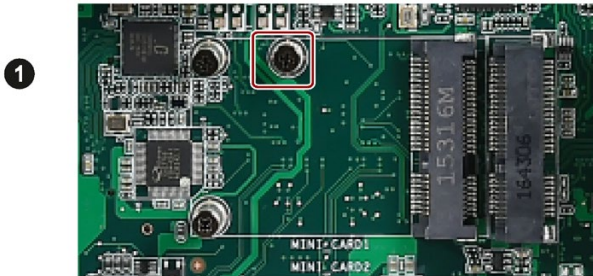

- 1 Remove the screw head of the half-size min card holder.

- 2 Insert a half-size mini PCIe card into the slot.
- 3 Secure the card with the screw that you removed from the card holder into the same hole.

### Install a full-size mini card

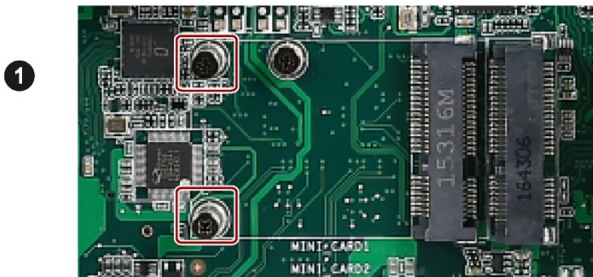

- 1 Remove the screw head of the full-size min card holder.

- 2 Insert a full-size mSATA card or a mini card with USB2.0 interface into the slot.
- 3 Secure the card with the screw that you removed from the card holder into the same hole.



## Set the antenna

Follow the below instructions to set the antenna if your cards have an external antenna.



**1** Remove the flaps of the two holes with a screw driver.

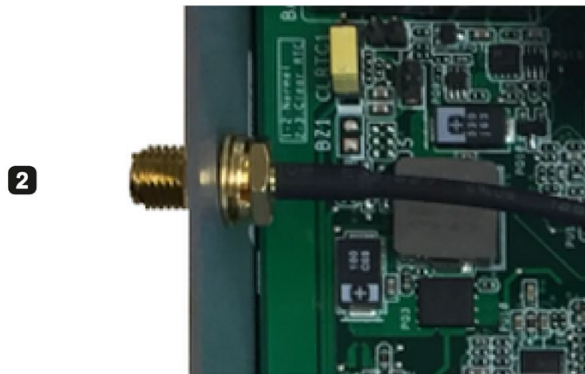

**2** Secure the antenna in the device through the hole.

## Maintaining and repairing the device

### 7.1 Maintenance

To maintain high system availability, we recommend the preventative replacement of those PC components that are subject to wear. The table below indicates the intervals for this replacement.

Component	Replacement interval:
Hard disk drive / Solid state drive	3 years
CMOS backup battery	5 years

<sup>1</sup> The interval for replacement depends greatly on the type of use. A specific interval cannot be given.

### 7.2 Repair information

#### Carrying out repairs

Only qualified personnel are permitted to repair the device.

 <b>WARNING</b>
<p><b>Unauthorized opening and improper repairs on the device may result in substantial damage to equipment or endanger the user.</b></p> <ul style="list-style-type: none"> <li>• Always disconnect the power plug before you open the device.</li> <li>• Only install system expansion devices designed for this device. If you install other expansion devices, you may damage the device or violate the safety requirements and regulations on RF suppression. Contact your technical support team or where you purchased your PC to find out which system expansion devices may be installed.</li> </ul>

If you install or exchange system expansions and damage your device, the warranty becomes void.

 <b>CAUTION</b>
<p><b>Electrostatic sensitive devices (ESD)</b></p> <p>The device contains electronic components which are destroyed by electrostatic charges. This can result in malfunctions and damage to the machine or plant.</p> <p>Make sure you take precautionary measures even when you open the device, for example, when opening device doors, device covers or the housing cover. For more information, refer to the chapter "ESD guideline (Page 59)"</p>

### Limitation of liability

All technical specifications and approvals of the device only apply if you use expansion components that have a valid CE approval (CE mark). The installation instructions for expansion components in the associated documentation must be observed.

UL approval of the device only applies when the UL-approved components are used according to their "Conditions of Acceptability".

We are not liable for functional limitations caused by the use of third-party devices or components.

### Tools

Tools to open the device, see section "Open the device (Page 41)". You can make repairs on the device with the following tools:

- T20 screwdriver for function earth connection and enclosure
- T10 screwdriver for all of the remaining screws

## 7.3 Cleaning the Device Front

The device is designed for low-maintenance operation. You should still clean the device front regularly, however.

 <b>CAUTION</b>
<p><b>Unwanted reactions when cleaning the device</b></p> <p>You risk unintentional actuation of control elements if you clean the device while it is switched on.</p> <p>You may possibly trigger unwanted actions of the device or controller that are liable to cause personal injury or damage to the machinery.</p> <p>Always cut off the power supply of the device before you clean it.</p>

## Cleaning Agents

### NOTICE

#### Damage to the device caused by impermissible cleaning agents

Impermissible and unsuitable cleaning agents may cause damage to the device.

Use dish soap or foaming screen cleaner only as cleaning agents. Do not use the following cleaning agents:

- Aggressive solvents or scouring powder
- Steam jets
- Compressed air

## Cleaning the Device Front

1. Cut off the power supply of the device.
2. Dampen the cleaning cloth.
3. Spray the cleaning agent on the cloth and not directly on the device.
4. Clean the device with the cleaning cloth.

## 7.4 Recycling and disposal

The devices described in these operating instructions can be recycled thanks to their low level of pollutants. Contact a certified disposal service company for environmentally sound recycling and disposal of your old devices.



## 7.5 Installing and removing hardware

### 7.5.1 Replacing the backup battery

#### Prior to replacement

 <b>WARNING</b>
<b>Risk of explosion and release of harmful substances</b> Improper handling of lithium batteries can result in an explosion of the batteries. Explosion of the batteries and the released pollutants can cause severe physical injury. Worn batteries jeopardize the function of the device. Note the following when handling lithium batteries: <ul style="list-style-type: none"><li>• Replace the battery every 5 years.</li><li>• Replace the lithium battery only with the type recommended by the manufacturer (type: CR2032).</li><li>• For any requirements on product maintenance, contact Siemens Technical support (Page 93).</li><li>• Do not throw lithium batteries into fire, do not solder on the cell body, do not recharge, do not open, do not short-circuit, do not reverse polarity, do not heat above 100°C and protect from direct sunlight, moisture and condensation.</li></ul>

<b>NOTICE</b>
<b>Disposal of batteries</b> Batteries do not belong in domestic garbage. The user is legally obliged to return used batteries. Used batteries pollute the environment as special waste. You as a user are liable to prosecution if you do not properly dispose of batteries. Please observe the following when disposing of batteries: <ul style="list-style-type: none"><li>• Dispose of used batteries as hazardous waste in accordance with local regulations.</li><li>• You can return used batteries to public collection points and wherever batteries of the type in question are sold.</li><li>• Label the battery container "Used batteries".</li></ul>

#### Requirement

- The device is disconnected from the power supply.
- The device is opened.

### Procedure - removing

<b>NOTICE</b>
<b>Time may be deleted</b>
The time will be deleted if it takes you longer than 30 seconds to replace the battery. The device is no longer synchronous. Time-controlled programs will no longer run or will run at the wrong time. This may damage the plant.
Reset the time for the device.

#### Basic device

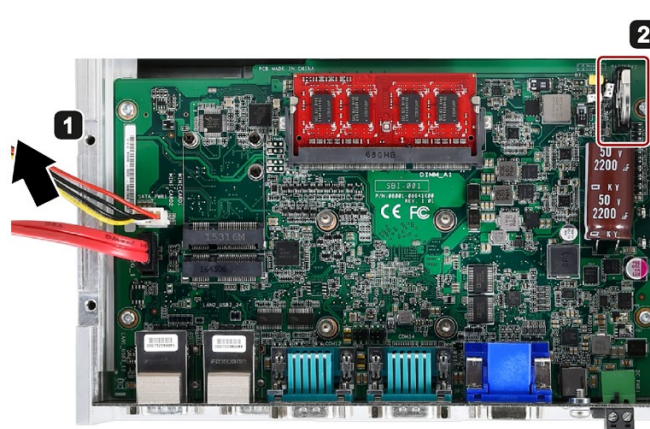

**1** Lift up the cover slightly and open it carefully.  
Lay the cover aside next to the device.

**2** Move the marked clip to one side, and then take out the battery.

### Procedure - installation

To install the replacement battery, follow the steps for removing the battery in the reverse order.

#### 7.5.2 Replacing the drive of a basic device

The procedure only applies to the basic device: Carry out the procedure if you want to replace the hard disk drive in the case of a fault.

Read the information in section "Repair information (Page 46)".

#### Requirement

- The device is open.
- A hard disk drive
- A T10 screwdriver

**Procedure - removing**

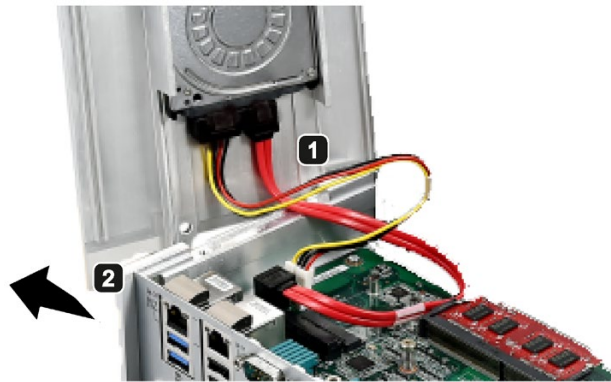

- 1** Pull out the connection plug.
- 2** Lay down the device's rear panel including the drive.

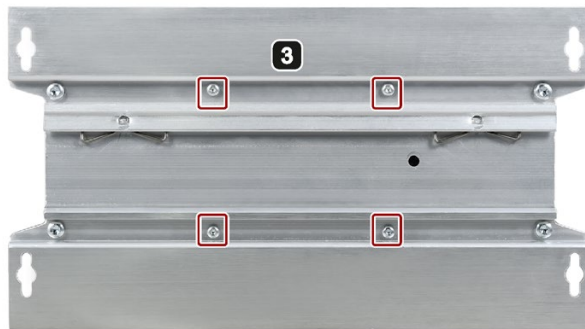

- 3** Remove the indicated screws.
- 4** Take out the HDD.

**Procedure - installation**

Proceed in reverse order.

**7.6 Installing the software**

Information on installation of the operating system is available on the Internet and on the supplied DVD:

Microsoft® Windows® 7 (<https://support.industry.siemens.com/cs/ww/en/view/109752041>)

Microsoft® Windows® 10 (<https://support.industry.siemens.com/cs/ww/en/view/109768887>)

**Note**

Before installing Windows 10, set the boot mode and video as **UEFI** in BIOS. On how to set the boot mode and Video, refer to Boot Setup (Page 85).

**Note**

To restore or recovery your Windows 10 system, you can use the Windows 10 restore DVD for IPC 327E/377E.

### 7.6.1 Installing the drivers

#### Requirements

- Windows 7/Windows Embedded Standard 7, or Windows 10 Operating System is installed in your IPC.
- You need to connect a mouse and a keyboard to your PC.
- You also need an external DVD drive to your PC.

#### Drivers list

The drivers need to be installed on Windows 7 and Windows 10 are different:

Operating system	Drivers needed
Windows 7/Windows Embedded Standard 7	<ul style="list-style-type: none"><li>• Chipset</li><li>• Graphic</li><li>• LAN</li><li>• Audio</li><li>• Touch</li><li>• Trusted Execution Engine</li><li>• xHCI (USB)</li></ul>
Windows 10	<ul style="list-style-type: none"><li>• Chipset</li><li>• Graphic</li><li>• LAN</li><li>• Audio</li><li>• Touch</li><li>• Trusted Execution Engine</li></ul>

#### To open the driver list

1. Put the *Documentation and Drivers* DVD into the external DVD drive.
2. Double-click **My Computer** → **Documentation and Drivers** to open the DVD.
3. Double-click **index.htm**.
4. Click **Drivers** to open the available OS list.
5. Click the OS you use.

The available driver list opened.

#### Alternative way to access the drivers

You can also find the drivers in the below path of the *Documentation and Drivers* DVD.

---

E:\Drivers

---

**Note**

Install the Windows system patch before installing the Intel chipset driver.

---

**Step 1: install Intel chipset driver**

1. Click **Setup Chipset Driver**.
2. Click  to install the chipset driver.
3. Click **Next** to continue.
4. Click **Accept** to accept the license agreement.
5. Click **Install** to allow the computer to start the installation.  
The installation starts.
6. Click **Yes** to confirm the user account control question.
7. Click **Finish**.  
The chipset installation is completed.

**Step 2: install the Intel graphic driver**

1. Click **Setup Graphic Driver**.
2. Click  to install the chipset driver.
3. Click **Yes** to confirm the user account control question.
4. Click **Next** to continue
5. Click **Yes** to accept license agreement.
6. Click **Next** to confirm the *Readme File Information* and move on.  
The installation starts.
7. Click **Next** to continue the installation.
8. Select the radio button next to "**Yes, I want to restart this computer now.**" and click **Finish** to restart the computer for the changes to take effect.

**Step 3: install LAN driver**

1. Click **Setup LAN Driver**.
2. Click  to install the chipset driver.
3. Click **Yes** to confirm the user account control question.
4. Click **Next** to continue.
5. Select the radio button before "**I accept the terms in the license agreement**", and click **Next** to accept license agreement.

6. Set the setup option as you like and click **Next**.
7. Click **Install** to start the driver installation.
8. Click **Finish**.

The installation is completed.

#### Step 4: install Realtek AUDIO driver

1. Click **Setup Audio Driver**.
2. Click  to install the Audio driver.
3. Click **Yes** to confirm the user account control question.
4. Click **Yes** to continue.
5. Click **Install** to continue the installation.
6. Select the radio button next to **"Yes, I want to restart my computer now."** and click **OK** to restart the computer for the changes to take effect.

#### Step 5: install Touch driver

1. Click **Setup Touch Driver**.
2. Click  to install the Audio driver.
3. Click **Yes** to confirm the user account control question.
4. Click **Next** to continue the installation.
5. Select the Destination Folder and click **Next**.
6. Type a new program folder name or select one from the existing folders list, and then click **Next**.
7. Click **Next** to continue the installation.
8. Select the radio button next to **"Yes, I want to restart this computer now."** and click **Finish** to restart the computer for the changes to take effect.
9. After restart the computer, the system will do 4 points calibration automatically.

#### Step 6: install Intel Trusted Execution Engine driver

1. Click **Setup Trusted Execution Engine Driver**.
2. Click  to install the Intel Trusted Execution Engine driver.
3. Click **Yes** to confirm the user account control question.
4. Click **Next** to continue.
5. Select the radio button before **"I accept the terms in the License Agreement"**, and click **Next** to accept license agreement.

6. Click **Next** to start the driver installation.

7. Click **Finish**.

The installation is completed.

#### Optional step: install xHCI driver

1. Click **Setup xHCI (USB) Driver**.

2. Click  to install the chipset driver.

3. Click **Yes** to confirm the user account control question.

4. Click **Next** to continue.

5. Click **Yes** to accept license agreement.

6. Click **Next** to confirm the *Readme File Information* and move on.

The installation starts.

7. Click **Next** to continue.

8. Select the radio button next to "**Yes, I want to restart my computer now.**" and click **Finish** to restart the computer for the changes to take effect.

# Technical specifications

## 8.1 Certificates and approvals

---

**Note****Applicability**

The following shows the approvals that may be available. For the device itself, it is certificated as shown on the product label and package label.

---

### ISO 9001 certificate

The Siemens quality management system for all production processes (development, production and sales) meets the requirements of GB/T 19001-2008/ISO 9001:2008, ISO 14001:2004 + Cor. 1:2009 and BS OHSAS 18001:2007.

Certificate registration no. 01 100 1430201, 01 104 1430201 and 01 113 1430201.

### Software license agreements

If the device is supplied with preinstalled software, you must observe the corresponding license agreements.

### CE marking



2014/30/EU Directive of the European Parliament and of the Council of 26 February 2014 on the harmonisation of the laws of the Member States relating to electromagnetic compatibility; Official Journal of the EU L96, 29/03/2014, p. 79–106

EMC EN 61000-6-4:2007 + A1:2011, EN 61000-6-2:2005



## FCC and Canada

USA	
Federal Communications Commission Radio Frequency Interference Statement	This equipment has been tested and found to comply with the limits for a Class A digital device, pursuant to Part 15 of the FCC Rules. These limits are designed to provide reasonable protection against harmful interference when the equipment is operated in a commercial environment. This equipment generates, uses, and can radiate radio frequency energy and, if not installed and used in accordance with the instruction manual, may cause harmful interference to radio communications. Operation of this equipment in a residential area is likely to cause harmful interference in which case the user will be required to correct the interference at his own expense.
Shielded cables	Shielded cables must be used with this equipment to maintain compliance with FCC regulations.
Modifications	Changes or modifications not expressly approved by the manufacturer could void the user's authority to operate the equipment.
Conditions of operations	This device complies with Part 15 of the FCC Rules. Operation is subject to the following two conditions: (1) this device may not cause harmful interference, and (2) this device must accept any interference received, including interference that may cause undesired operation.

CANADA	
Canadian notice	This Class A digital apparatus complies with Canadian ICES-003.
Avis Canadian	Cet appareil numérique de la classe A est conforme à la norme NMB-003 du Canada.

### Responsible party for Supplier's Declaration of Conformity

Siemens Industry, Inc.  
Digital Factory - Factory Automation  
5300 Triangle Parkway, Suite 100  
Norcross, GA 30092  
USA  
Mail to ([amps.automation@siemens.com](mailto:amps.automation@siemens.com))

### UL approval



The following approvals are available for the device:

- Underwriters Laboratories (UL) in accordance with Standard UL61010-1 and UL61010-2-201 (IND.CONT.EQ), File E472609
- Canadian National Standard CAN/CSA No.61010-1-12 and CAN/CSA C22.2 No.61010-2-201

### Identification for Eurasian Customs Union



- EAC (Eurasian Conformity)
- Customs union of Russia, Belarus and Kazakhstan
- Declaration of conformity according to Technical Regulations of the Customs Union (TR CU)

### Korea Certificate



This product meets the requirements of Korean certification.

This product satisfies the requirement of the Korean Certification (KC Mark).

이 기기는 업무용(A 급) 전자파 적합기기로서 판매자 또는 사용자는 이 점을 주의하시기  
바라며 가정 외의 지역에서 사용하는 것을 목적으로 합니다.

### BSMI



This product meets the requirements of CNS15663(102/07), CNS13438(095/06/01) generic standard.

警告使用者：本產品是甲類的資訊產品，在居家的環境中使用時，可能會造成射頻干擾，在  
這類情況下，使用者會被要求採取某些適當的對策。

### WEEE label (European Union)



Disposal instructions, observe the local regulations and the section "Recycling and disposal (Page 48)".

## 8.2 Directives and declarations

### 8.2.1 Electromagnetic compatibility for industrial environments

#### Electromagnetic compatibility

This product meets the requirements of EC Directive 2014/30/EU "Electromagnetic Compatibility".

The device is designed for the following areas of application corresponding to the CE marking:

Scope of application	Requirements for	
	Interference emission	Immunity to interference
Industrial area	EN 61000-6-4:2007 +A1:2011	EN 61000-6-2:2005

### 8.2.2 ESD guideline

#### What does ESD mean?

An electronic module is equipped with highly integrated components. Due to their design, electronic components are highly sensitive to overvoltage and thus to the discharge of static electricity. Such electronic components or modules are labeled as electrostatic sensitive devices.

The following abbreviations are commonly used for electrostatic sensitive devices:

- ESD – Electrostatic sensitive device
- ESD – Electrostatic Sensitive Device as a common international designation

Electrostatic sensitive devices can be labeled with an appropriate symbol.



#### NOTICE

##### Damage to ESD from touch

Electrostatic sensitive devices, ESD, can be destroyed by voltages which are far below the human perception limit. If you touch a component or electrical connections of a module without discharging any electrostatic energy, these voltages may arise.

The damage to a module by an overvoltage can often not be immediately detected and only becomes evident after an extended period of operation. The consequences are incalculable and range from unforeseeable malfunctions to a total failure of the machine or system.

Avoid touching components directly. Make sure that persons, the workstation and the packaging are properly grounded.

### Charge

Every person without a conductive connection to the electrical potential of his/her surroundings can be electrostatically charged.

The material with which this person comes into contact is of particular significance. The figure shows the maximum electrostatic voltages with which a person is charged, depending on humidity and material. These values conform to the specifications of IEC 61000-4-2.

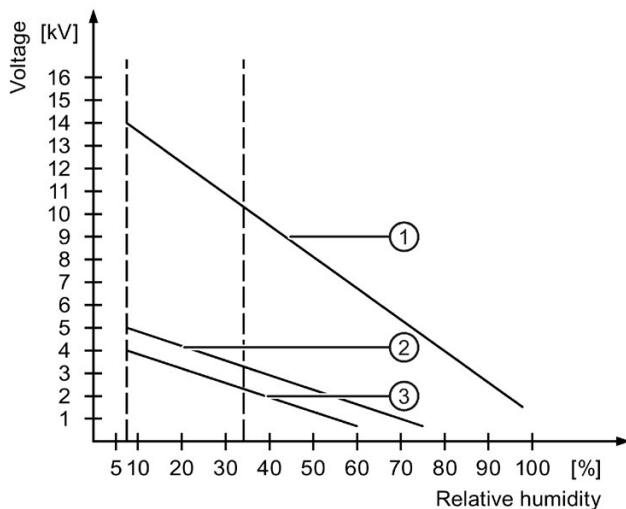

- ① Synthetic materials
- ② Wool
- ③ Antistatic materials such as wood or concrete

<b>NOTICE</b>
<b>Grounding measures</b>
There is no equipotential bonding without grounding. An electrostatic charge is not discharged and may damage the ESD.
Protect yourself against discharge of static electricity. When working with electrostatic sensitive devices, make sure that the person and the workplace are properly grounded.

### **Protective measures against discharge of static electricity**

- Disconnect the power supply before you install or remove modules which are sensitive to ESD.
- Pay attention to good grounding:
  - When handling electrostatic sensitive devices, make sure that persons, the workstation and devices, tools and packaging used are properly grounded. This way you avoid static discharge.
- Avoid direct contact:
  - As a general rule, do not touch electrostatic sensitive devices, except in the case of unavoidable maintenance work.
  - Hold the modules at their edge so that you do not touch the connector pins or conductor paths. This way, the discharge energy does not reach and damage the sensitive components.
  - Discharge your body electrostatically before you take a measurement at a module. Do so by touching grounded metallic parts. Always use grounded measuring instruments.

### 8.3 Dimension drawings

#### 8.3.1 Dimension drawing 12" device

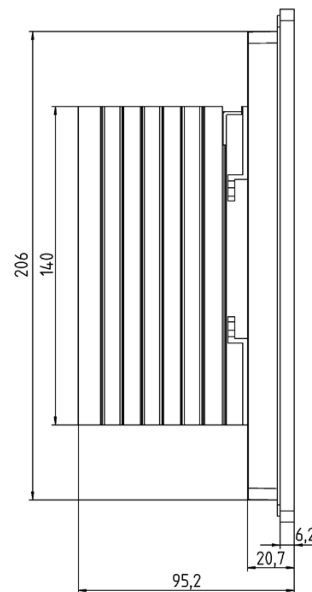
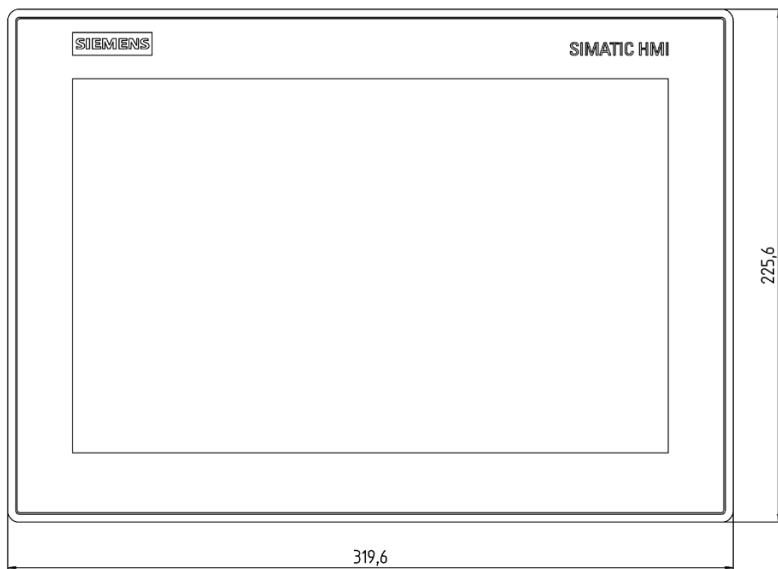
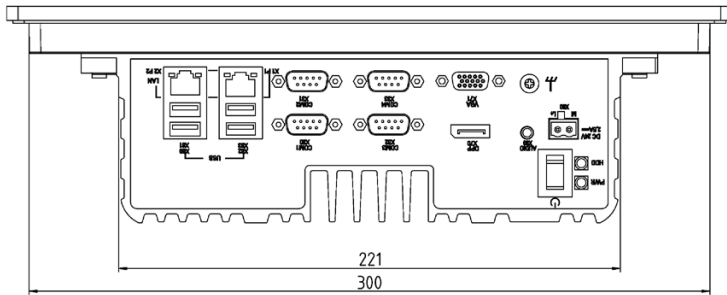

all dimensions in mm

### 8.3.2 Dimension drawing 15" device

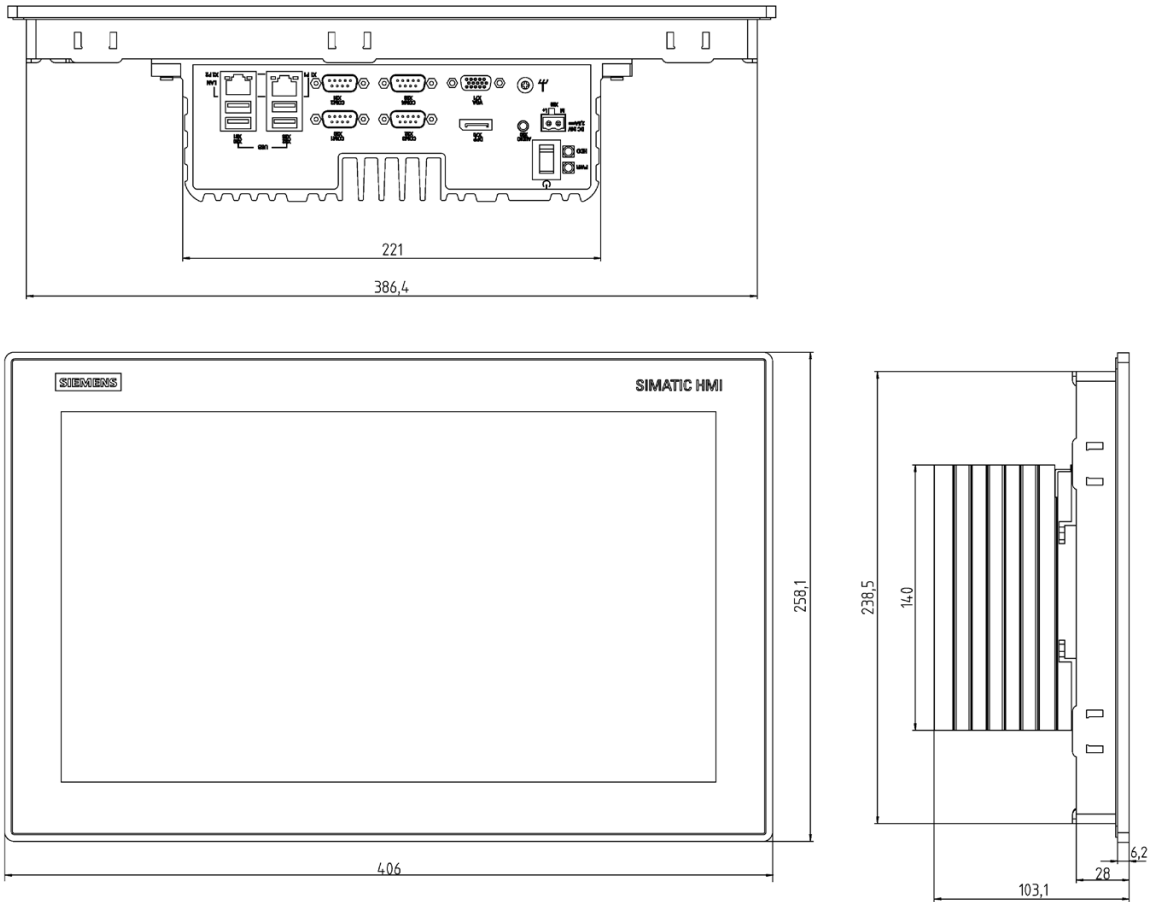

all dimensions in mm

### 8.3.3 Dimension drawing 19" device

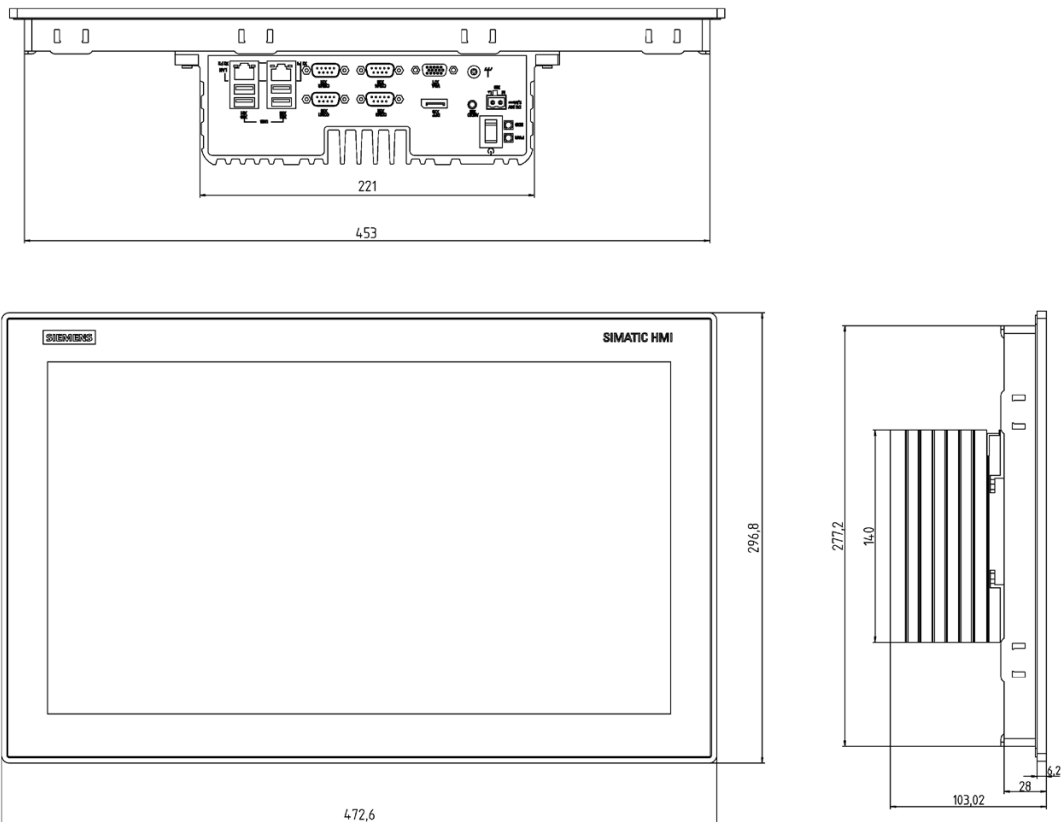

all dimensions in mm

## 8.4 Technical data

### 8.4.1 General technical specifications

Device	12" device	15" device	19" device
Weight	3.6 kg	5.1 kg	6.0 kg
Power supply <sup>1</sup>	24V DC (20.4 to 28.8 V)		
Power consumption (DC): The current may differ depending on the operating mode and extensions.	Continuous current	Continuous current	Continuous current
	<ul style="list-style-type: none"> <li>24 V, 1.4 A</li> </ul> maximum current <ul style="list-style-type: none"> <li>2.5 A at 20.4 V</li> </ul>	<ul style="list-style-type: none"> <li>24 V, 1.5 A</li> </ul>	<ul style="list-style-type: none"> <li>24 V, 1.9 A</li> </ul>
Noise emission	< 40 dB(A) according to DIN 45635-1		



Degree of protection	<ul style="list-style-type: none"> <li>IP40 (except front panel)</li> <li>IP65 (front panel)</li> </ul> in accordance with IEC 60529
Protection class	Protection class III in accordance with IEC 61140
Quality assurance	In accordance with ISO 9001

<sup>1</sup> The device should only be connected to a 24 VDC power supply which meets the requirements of safe extra low voltage (SELV) according to IEC/EN/DIN EN/UL 60950-1. The power supply must fulfill the requirement NEC Class 2 or LPS according to IEC/EN/DINEN/UL 60950-1.

## Electromagnetic compatibility

Radiation Emission (Enclosure port) in accordance with IEC 61000-6-3 + A1/ EN61000-6-4+A1	30 to 230 MHz / 40dB(μV/m) quasi-peak 230 to 1000 MHz / 47dB(μV/m) quasi-peak 1 GHz to 3 GHz / 76 dB(μV/m) peak, 56 dB(μV/m) average 3 GHz to 6 GHz / 80 dB(μV/m) peak 60 dB(μV/m) average
Immunity with regard to conducted interference on the supply lines	± 2 kV in accordance with IEC 61000-4-4; Burst ± 1 kV in accordance with IEC 61000-4-5; Surge, line to line
Noise immunity on signal lines	± 1 kV to IEC 61000-4-4; Burst; Length < 30 m ± 2 kV in accordance with IEC 61000-4-4; Burst; length ≥ 30 m ± 2 kV in accordance with IEC 61000-4-5; Surge; length ≥ 30 m
Immunity to electrostatic discharge	± 6 kV contact discharge at the front in accordance with IEC 61000-4-2 ± 8 kV air discharge in accordance with IEC 61000-4-2
Immunity to RF interference	10 V/m, 80 to 1000 MHz, 80 % AM according to IEC 61000-4-3 3 V/m, 1.4 GHz to 6 GHz, 80 % AM according to IEC 61000-4-3
Conducted Emission (Low voltage DC mains port), in accordance with IEC 61000-6-4 + A1	0.15 to 0.5 MHz / 79 dB (μV) Q, 66 dB (μV) M 0.5 to 30 MHz / 73 dB (μV) Q, 60 dB (μV) M
Conducted Emission (Telecommunications/Network Port), in accordance with IEC 61000-6-4 + A1	0,15 to 0,5 MHz: 97 dB(μV) to 87 dB(μV) Q 84 dB(μV) to 74 dB(μV) M 0,5 MHz to 30 MHz: 87 dB(μV) Q / 74 dB(μV) M
Immunity to magnetic fields	30 A/m, 50/60 Hz according to IEC 61000-4-8

## Main circuit board

Processor	<ul style="list-style-type: none"> <li>Intel Celeron N3160: Quad Core, 1.6 GHz, burst frequency 2.24 GHz, 2 MB 2nd level cache, 6 W TDP</li> </ul>
Main memory	DDR3L memory up to 8 GB, 1× SODIMM modules / non-ECC
Expansion slots	<ul style="list-style-type: none"> <li>1 Mini PCIe half-size slot</li> <li>1 mSATA slot with USB2.0 bus signal</li> </ul>

### Drive, memory medium

Hard disk drive, optional	≥ 500 GB, 2.5" HDD
Solid state drive, optional	256GB, 2.5" SSD
Floppy and CD-ROM drive	External, can be connected via USB port <sup>1</sup>
USB stick	External, can be connected via USB port

<sup>1</sup> Only to device USB port, not via USB hub

### Graphics

Display, resolution	<ul style="list-style-type: none"> <li>• 12" screen diagonal with backlighting, resolution 1280 × 800 pixels</li> <li>• 15" screen diagonal with backlighting, resolution 1366 × 768 pixels</li> <li>• 19" screen diagonal with backlighting, resolution 1366 × 768 pixels</li> </ul>
Touch controller	Resistive Touch controller ETP-CP-MER4485XRU Touch screen analog resistive Touch force with R0.8 Delin stylus pen, at 250g forces
Backlighting (MTBF) Half brightness life time, typical	LCD min. 50000 h at 25 °C, 50% brightness
Pixel error class in accordance with ISO 9241-307	III
Graphics controller	Integrated Graphic Controller
Resolution	<ul style="list-style-type: none"> <li>• at least support 2 channels: 1 x VGA(DB-15) + 1 x DP(DDI)</li> <li>• 32bit, support from 640*480 pixels to 1920*1200 pixels</li> <li>• support backlight control</li> </ul>

### Interfaces

COM	<ul style="list-style-type: none"> <li>• RS 232, max. 115 Kbps, D-sub connector, 9-pin</li> <li>• RS 232 /RS 422 /RS 485 <sup>1</sup> (optional), max. 115 Kbps, D-sub connector, 9-pin</li> </ul>
USB	<ul style="list-style-type: none"> <li>• USB 2.0, high speed/high current,</li> <li>• USB 3.0, high current</li> </ul> <p>You can find additional information in the section Power supply (Page 68).</p>
LAN interface X1 P1, RJ45	Intel Ethernet Controller I211-AT 10, 100, 1000 Mbps

LAN interface X2 P1, RJ45	Intel Ethernet Controller I211-AT 10, 100, 1000 Mbps
Keyboard, mouse	Connection via USB port

<sup>1</sup> In BIOS Setup, you can configure support for RS 232/ RS 422/ RS 485 for COM1 and COM2 ports.

## 8.4.2 Environmental conditions

### Climatic ambient conditions

For permitted mounting positions, see section Preparing for installation (Page 17).

Temperature, tested in accordance with IEC 60068-2-1, IEC 60068-2-2 and IEC 60068-2-14	
Operation, USB load max. 6 W, mini card load max. 1 W:	0 °C to +40 °C applies to 12", 15" and 19" devices for all permitted mounting positions 0 °C to +45 °C applies to device for all permitted mounting positions for SSD configuration
Temperature during storage/transport	-20°C to +60 °C
Gradient	<ul style="list-style-type: none"> <li>• Operation: Max. 10 °C/h</li> <li>• Storage: 20 °C/h, no condensation</li> </ul>
Relative humidity, tested in accordance with IEC 60068-2-78, IEC 60068-2-30	
Operation	5% to 85% at 30 °C, no condensation
Storage/transport	5% to 95% at 25/55 °C, no condensation
Atmospheric pressure	
Operation	1080 to 795 hPa, corresponds to an elevation of -1000 to 2000 m
Storage/transport	1080 to 660 hPa, corresponds to an elevation of -1000 to 3500 m

### Mechanical ambient conditions

Vibration, tested in accordance with DIN IEC 60068-2-6	
Operation	With hard disk : <ul style="list-style-type: none"> <li>• 10 to 58 Hz: 0.0375 mm</li> <li>• 58 to 200 Hz: 4.9 m/s<sup>2</sup></li> </ul> With SSD : <ul style="list-style-type: none"> <li>• 10 to 58 Hz: 0.075 mm</li> <li>• 58 to 200 Hz: 9.8 m/s<sup>2</sup></li> </ul>

8.4 Technical data

Storage/transport	<ul style="list-style-type: none"> <li>• 5 to 8.4 Hz: 3.5 mm</li> <li>• 8.4 to 500 Hz: 9.8 m/s<sup>2</sup></li> </ul>
Shock resistance, tested in accordance with IEC 60068-2-27, IEC 60068-2-29	
Operation	<ul style="list-style-type: none"> <li>• With hard disk: 9.8 m/s<sup>2</sup>, 20 ms;</li> <li>• With SSD: 150 m/s<sup>2</sup>, 11 ms;</li> </ul>
Storage/transport	<ul style="list-style-type: none"> <li>• 250 m/s<sup>2</sup>, 6 ms</li> </ul>

### 8.4.3 Power supply

#### Maximum permitted current consumption at the USB ports

Auxiliary components		Maximum permitted power consumption			Max. total power
		+5 V	+3.3 V	+1.5 V	
USB device 3.0	High current	900 mA	-	-	6 W (for all USB devices)
	Low current	100 mA	-	-	
USB Device 2.0	High current	500 mA	-	-	
Mini PCIe module	Per slot	-	1.5 A <sup>1</sup>	0.5 A <sup>2</sup>	1 W in total
mSATA module	Per slot	-	1.5 A <sup>1</sup>	0.5 A <sup>2</sup>	

<sup>1</sup> May amount to maximum 3.0 A for up to 100 ms at start-stop torque of device.

<sup>2</sup> May amount to maximum 1.2 A for up to 100 ms at start-stop torque of device

#### DC power supply

	12" device	15" device	19" device
Input voltage	24 VDC (20.4 to 28.8 VDC)		
Power consumption <sup>1</sup>	Max. 30 W	Max. 35 W	Max. 45 W
Power failure buffering	Hold-up time > 10 ms		

<sup>1</sup> The performance specifications apply to the power supply component, but not to the device.

**Note**

**Inrush current**

The device needs an inrush current of at least 4 A for 25 ms.

The peak value of the inrush current depends on the input voltage and the impedance of the 24 V source; peak currents in excess of 4 A are possible. This will not have a negative impact on device functionality.

## 8.5 Hardware description

### 8.5.1 Technical features of the motherboard

Component / port	Description	Parameters
Chipset	integrated in CPU	
CPU	Intel Celeron N3160	
Memory	DDR3L SODIMM	2 GB, 4 GB and 8 GB
Graphics	Integrated graphics	up to 512 MB graphics memory taken dynamically from RAM

### 8.5.2 External interfaces

#### 8.5.2.1 Overview of interfaces

Interface	Position	Description
COM	External	9-pin D-sub: <ul style="list-style-type: none"> <li>• 2 x RS 232</li> <li>• 2 x RS 232/ RS 422/ RS 485</li> </ul>
USB <sup>1</sup>	External	2 x USB 3.0 2 x USB 2.0
Ethernet	External	2 x RJ45 10/100/1000 Mbps
DisplayPort	External	1 x DP 1 x VGA

<sup>1</sup> Only two of these USB ports may be operated simultaneously in high current mode, max. 6 W.

8.5.2.2 DC in connector

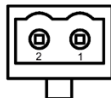

Pin	Short description
1	24V
2	GND

8.5.2.3 Serial interface

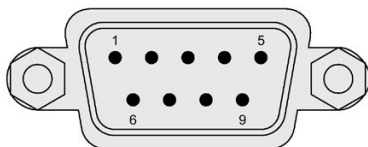

RS232

RS422

RS485

Pin assignment RS232

Pin	Short description	Meaning
1	DCD	Data carrier detect (I)
2	RxD	Received data (I)
3	TxD	Transmitted data (O)
4	DTR	Data terminal ready (O)
5	M	Ground
6	DSR	Data set ready (I)
7	RTS	Request to send (O)
8	CTS	Clear to send (I)
9	RI	Incoming call (I)

Pin assignment RS422

Pin	Short description	Meaning
1	TX-	Transmit data - (O) for full-duplex mode
2	TX+	Transmit data + (O) for full-duplex mode
3	RX+	Receive data + (I) for full-duplex mode
4	RX-	Receive data - (I) for full-duplex mode
5	M	Signal ground
6	nc	
7	nc	

Pin	Short description	Meaning
8	nc	
9	nc	

### Pin assignment RS485

Pin	Short description	Meaning
1	Data-	Transmit / receive data - (I/O) for half-duplex mode
2	Data+	Transmit / receive data+ (I/O) for half-duplex mode
3	nc	
4	nc	
5	M	Signal ground
6	nc	
7	nc	
8	nc	
9	nc	

### 8.5.2.4 USB 2.0 port



Pin	Short description	Meaning
1	USB_P5V_fused (O)	+5 V, fused
2	USB_D0M (I/O)	Data-
3	USB_D0P (I/O)	Data+
4	USB_GND	GND

### 8.5.2.5 USB 3.0 port

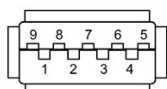

Pin	Short name	Meaning	Input / output
1	VBUS	+ 5 V (fused)	Output
2	D-	Data channel USB2	Input / output
3	D+	Data channel USB2	Input / output
4	GND	Ground	-
5	RX-	Data channel USB3	Input
6	RX+	Data channel USB3	Input
7	GND	Ground	-

8	TX-	Data channel USB3	Output
9	TX+	Data channel USB3	Output

### 8.5.2.6 DisplayPort

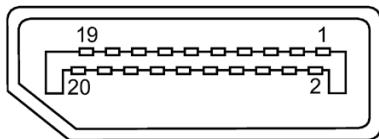

Pin	Short name	Meaning	Input / output
1	ML_Lane0+	DP data 0+	Output
2	GND	Ground	-
3	ML_Lane0-	DP data 0-	Output
4	ML_Lane1+	DP data 1+	Output
5	GND	Ground	-
6	ML_Lane1-	DP data 1-	Output
7	ML_Lane2+	DP data 2+	Output
8	GND	Ground	-
9	ML_Lane2-	DP data 2-	Output
10	ML_Lane3+	DP data 3+	Output
11	GND	Ground	-
12	ML_Lane3-	DP data 3-	Output
13	CONFIG1 CAD	Cable Adapter Detect	Input
14	CONFIG2	Ground (PullDown)	-
15	AUX_CH+	Auxiliary channel+	Bidirectional
16	GND	Ground	-
17	AUX_CH-	Auxiliary channel-	Bidirectional
18	HPD	Hot Plug Detect	Input
19	GND	Ground	-
20	DP_PWR	+3.3V (fused)	Output

### 8.5.2.7 Ethernet port

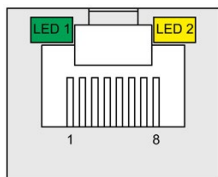

Pin	Short description	Meaning
1	BI_DA+	Bidirectional data A+, input/output
2	BI_DA-	Bidirectional data A-, input/output



Pin	Short description	Meaning
3	BI_DB+	Bidirectional data B+, input/output
4	BI_DC+	Bidirectional data C+, input/output
5	BI_DC-	Bidirectional data C-, input/output
6	BI_DB-	Bidirectional data B-, input/output
7	BI_DD+	Bidirectional data D+, input/output
8	BI_DD-	Bidirectional data D-, input/output

LED	Short description	Meaning
1	LED 1	Off: Port is Not Active Lit orange: Port is Active, but No Data Activity Blinking: Port is Active and there is Data Activity
2	LED 2	Off: 10Mbps Lit red: 100Mbps Lit green: 1Gbps

## 8.5.3 Internal interface

### 8.5.3.1 Overview of internal interfaces

Interface	Position	Connect- or	Description
Mini PCIe x1	Internal		PCIe x1 interface
mSATA x 1	internal		mSATA x 1 interface with USB2.0 signal

### 8.5.3.2 Mini PCIe and mSATA interface

Assignment of the PCIe x1 interface					
Top side			Bottom side		
Pin no.	Name	Description	Pin no.	Name	Description
1	WAKE#	Signal for link reactivation	2	3.3 V	3.3 V power
3	Reserved**		4	GND	Ground
5	Reserved**		6	1.5 V	1.5 V power
7	CLKREQ#	Clock request	8	UIM PMR	
9	GND	Ground	10	UIM DATA	
11	REFCLK-	Reference clock (differential pair)	12	UIM CLK	

Assignment of the PCIe x1 interface					
13	REFCLK+	Reference clock (differential pair)	14	UIM RESET	
15	GND	Ground	16	UIM VPP	
17	Reserved***(UIM_C 4)		18	GND	Ground
19	Reserved***(UIM_C 8)		20	W DISABLE#	
21	GND	Ground	22	PERST#	Fundamental reset
23	PERn0	Receiver differential pair, Lane 0	24	+3.3 Vaux	3.3 V power
25	PERp0	Receiver differential pair, Lane 0	26	GND	Ground
27	GND	Ground	28	+1.5 V	1.5 V power
29	GND	Ground	30	SMB_CLK	
31	PETn0	Transmitter differential pair, Lane 0	32	SMB_DATA	
33	PETp0	Transmitter differential pair, Lane 0	34	GND	Ground
35	GND	Ground	36	USB_D-	
37	Reserved*		38	USB_D+	
39	Reserved*		40	GND	Ground
41	Reserved*		42	LED_WWAN#	
43	Reserved*		44	LED_WLAN#	
45	Reserved*		46	LED_WPAN#	
47	Reserved*		48	+1.5 V	1.5 V power
49	Reserved*		50	GND	Ground
51	Reserved*		52	3.3 V	3.3 V power

### 8.5.4 Currently allocated system resources

All system resources (hardware addresses, memory utilization, interrupt assignment, DMA channels) are assigned dynamically by the Windows operating system, depending on the hardware equipment, drivers and connected external devices. You can view the current allocation of system resources or possible conflicts in the Control Panel.

## Procedure

To view the system resources, proceed as follows:

1. In the Windows Start menu, select "Start -> Run".
2. Enter "msinfo32" in the command prompt and confirm your entry with "OK".

## 8.6 BIOS description

### 8.6.1 BIOS getting started

#### BIOS setup utility: Aptio TSE

The motherboard's BIOS is developed on AMI based code. AMI provides Aptio™ Text Setup Environment (TSE), a test-based basic input and output system as BIOS setup utility. The purpose of Aptio™ TSE is to empower the user with complete system control at boot.

#### Getting BIOS setup

To enter BIOS Setup at startup:

1. Power on the motherboard.
2. Press **DELETE** or **ESC** key on your keyboard during the Power - On - Self - Test (POST) when the SIEMENS logo is shown on screen.

The Aptio™ TSE main BIOS setup menu is displayed.

You can access the other setup screens from the main BIOS setup menu, such as 'Advanced' or 'Chipset' menus.

#### NOTICE

- If **DELETE** or **ESC** is not pressed, POST continues its routines.
- If the timing is missed for entering BIOS setup during POST, a system reset is required by one of following methods:
  - Press **CTRL + ALT + DELETE** simultaneously.
  - Press the power button to turn off system then turn it on.

#### BIOS setup menu

The Aptio™ TSE BIOS setup menu is the first screen that you can navigate. Each BIOS setup menu option is described in this manual.

### Navigation

The Aptio™ TSE keyboard-based navigation can be accomplished using a combination of the keys, for example, function keys, **ENTER**, **ESC**, **ARROW** keys. Function description for navigation keys is listed below.

Press	To
→ ← : Select Screen	Menu Bar and select a BIOS setup page, for example, the Main page.
↑ ↓/Click : Select Item	Select a BIOS setup item or sub page.
Enter/Dbf Click : Select	Select an option to edit its value or access a sub menu.
+ / - : Change Opt.	Change the field value of a particular setup item, for example, date, time.
F1 : General Help	To display the general help window.
F2: Previous Values	To enable user to load previous values in BIOS setup Menu.
F3: Optimized Defaults	To enable user to load optimized default values in BIOS Setup Menu.
F4: Save & Exit	To enable user to save the current configuration and exit BIOS Setup Menu.
ESC/Right Click: Exit	The <ESC> Key or Right Click allows user to discard any change have made and exit BIOS Setup Menu. Press <ESC> Key or Right Click to exit BIOS Setup Menu without saving change. The following screen will appear: You can press <Enter> Key to discard changes and exit. Or use arrow keys to select “No” then press <Enter> Key to abort this function and return to previous screen.

### 8.6.2 Main setup

#### The main setup menu

The main setup menu is shown as below.

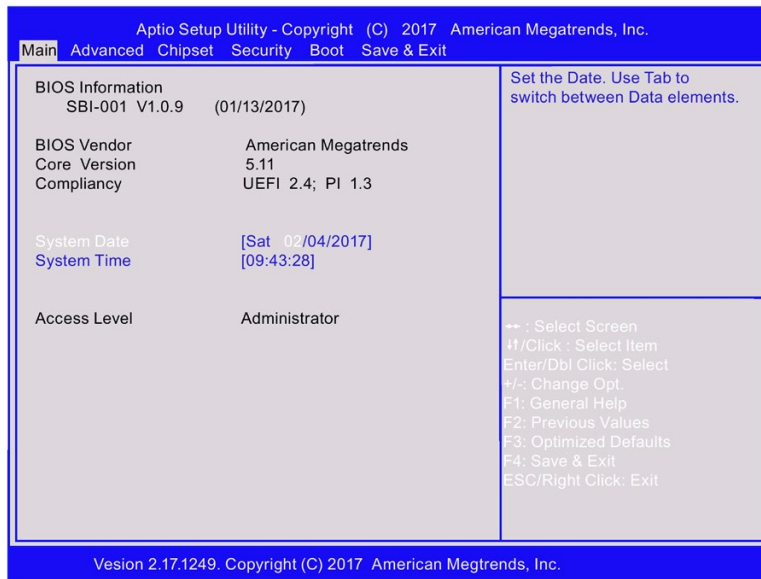

**Note**

Take the BIOS version installed on your IPC as standard.

**BIOS information**

Item	Description
BIOS information	Show the BIOS release information.
BIOS Vendor	Show the vendor information.
Core Version	Show the BIOS core version information.
Compliance	Show the UEFI specification version.

**System date**

1. Use arrow key to select the data.
2. Navigate to the month, day and year and type in the value as you need. Press **Enter** to jump to next filed.
3. Press **F4** key and save the change.

**System time**

1. Use arrow key to select the data.
2. Navigate to the hour, minute and second and type in the value as you need. Press **Enter** to jump to next filed.
3. Press **F4** key and save the change.

**Note**

Enter the time in the 24-hour format. For example, you should enter 06:30:00 for 6:30 AM.

**Access level**

Access level shows what access right you have to setup BIOS. For setting the access level, go to the chapter Security Menu.

Access right	Description
Administrator	Have full access right to change BIOS settings.
User	Have guest level access right and can only change limited items.

### 8.6.3 Advanced setup

#### Advanced setup

The **Advanced** setup menu allows you to change the settings for the CPU and other system devices.

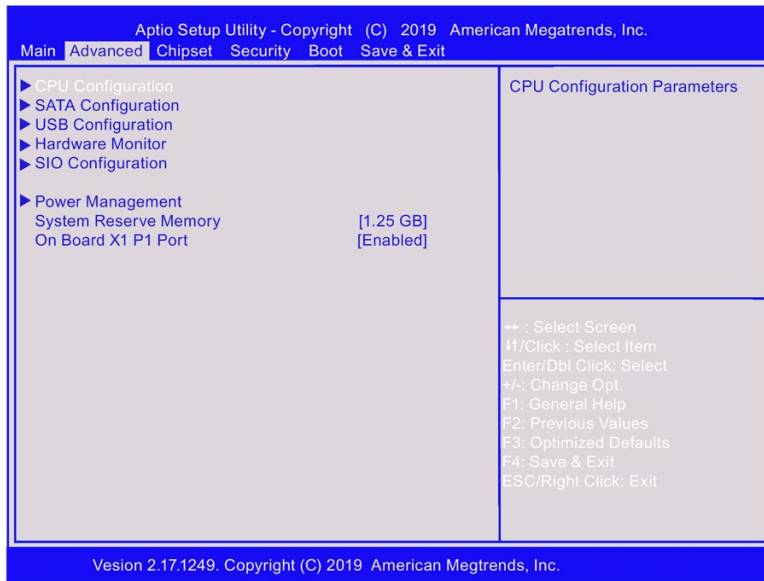

#### CPU Configuration

In CPU configuration page, you can view and configure CPU parameters.

##### Intel virtualization technology/EIST/Turbo Mode

You can enable or disable the intel virtualization technology with the following steps:

1. Select **Intel virtualization technology/EIST/Turbo Mode** with the arrow keys and press **Enter** key.
2. Select **Enabled** or **Disabled** as you need and press **Enter** key in the pop-up window.
3. Press **F4** key and save the change.

#### USB Configuration

In USB configuration page, you can view and configure USB parameters.

##### USB device

The USB device shows the USB device detected by BIOS during POST. If there is no device attached to the motherboard, only 2 Hubs is shown.

### Legacy USB support

You can enable or disable the USB support with the following steps:

1. Select **Legacy USB support** with the arrow keys and press **Enter** key.
2. Select **Enabled, Disabled** or **Auto** as you need and press **Enter** key in the pop-up window.
3. Press **F4** key and save the change.

See the configuration options for **Legacy USB support** below:

Configuration options	Description
Auto	This option disables Legacy USB Support if there is no USB device is connected.
Enabled	This option enables Legacy USB Support.
Disabled	This option keeps USB device available only for EFI application.

### USB3.0 Port 1,USB3.0 Port 2 and USB2.0 Ports

You can enable or disable the USB Ports Per-port disable control with the following steps:

1. Select **USB 3.0 Port 1** or **USB 3.0 Port 2** or **USB2.0 Ports** with the arrow keys and press **Enter** key.
2. Select **Enabled/Disabled** as you need and press **Enter** key in the pop-up window.
3. Press **F4** key and save the change.

---

#### Note

If you select **Disable** on **USB 2.0 Ports**, all the USB2.0 ports cannot be used.

---

## Hardware Monitor

In Hardware Monitor page, you can view and monitor the hardware status. See the hardware monitor parameters below:

Configuration options	Description
system temperature	Show the temperature inside chassis.
CPU temperature	Show the CPU temperature.
VCORE	Show VCORE power voltage.
+3.3V	Show +3.3V power voltage.
+5V	Show +5V power voltage.
+12V	Show +12V power voltage.
VCC3V	Show VCC3V power voltage.
VS3	Show VS3 power voltage.
VBAT	Show VBAT power voltage.

## SIO Configuration

In Super IO configuration page, you can view and configure super IO chip parameters.

### Serial port 1 configuration

Follow the steps below to enable or disable the serial port 1.

1. Select the port which you want to set with the arrow keys and press **Enter** key.
2. Select **Enabled** or **Disabled** as you need and press **Enter** key in the pop-up window.
3. The enabled port can select corresponding Change Setting and Device Mode and press **Enter** key.
4. Press **F4** key and save the change.

The table below is the detailed port setting.

Port type	Change Settings	Device Mode
Serial port 1	Auto IO=3F8h; IRQ=3; IO=2F8h; IRQ=3;	RS-232 RS-422 RS-485
Serial port 2	Auto IO=2F8h; IRQ=4; IO=3F8h; IRQ=4;	RS-232 RS-422 RS-485
Serial port 3	Auto IO=3E8h; IRQ=5; IO=2E8h; IRQ=5;	-
Serial port 4	Auto IO=2E8h; IRQ=7; IO=3E8h; IRQ=7;	-
Serial port 5	Auto IO=2D0h; IRQ=10; IO=2C0h; IRQ=10;	-
Serial port 6	Auto IO=2C0h; IRQ=11; IO=2D0h; IRQ=11;	-

See the options for device mode below:

Configuration options	Description
RS-232	To enable RS-232 mode for serial port 1/2.
RS-422	To enable RS-422 mode for serial port 1/2.
RS-485	To enable RS-485 mode for serial port 1/2.

See the baud rate for RS-422 and RS-485 below: 50, 75, 110, 134.5, 150, 300, 600, 1200, 1800, 2000, 2400, 3600, 4800, 7200, 9600, 19200, 38400, 57600, 115200.



## Power Management

You can view and configure power management in this page.

### Restore AC Power Loss

You can restore the AC power loss with the following steps:

1. Select **Last State, Always On and Always Off** with the arrow keys and press **Enter** key.
2. Press **F4** key and save the change.

See the configuration options for **Restore AC Power Loss** below:

Configuration options	Description
Always On	The system goes into on state after the AC power restores.
Always Off	The system goes into off state after the AC power restores.
Last State	The system goes into on state if system state was on before AC power loss; the system goes into off state if system state was sleep, hibernate or off before AC power loss.

### Resume from Network

You can enable or disable the function of resuming from network with the following steps:

1. Select **Resume from Network** with the arrow keys and press **Enter** key.
2. Select **Disabled** or **Enabled** as you need and press **Enter** key in the pop-up window.
3. Press **F4** key and save the change.

## System Reserve Memory

If you plug external mini PCIe device, you can adjust system reserve memory for mini PCIe device with the following steps:

1. Select **2 GB, 1.75 GB, 1.5 GB, 1.25 GB** or **1 GB** with the arrow keys and press **Enter** key.
2. Press **F4** key and save the change.

## On Board X1 P1 Port

You can enable or disable On Board X1 P1 Port with the following steps:

1. Select **Disabled** or **Enabled** as you need and press **Enter** key in the pop-up window.
2. Press **F4** key and save the change.

## 8.6.4 Chipset setup

### Chipset page

Select **Chipset** from the BIOS setup page to enter the Chipset BIOS setup page. The Chipset page is shown as below.

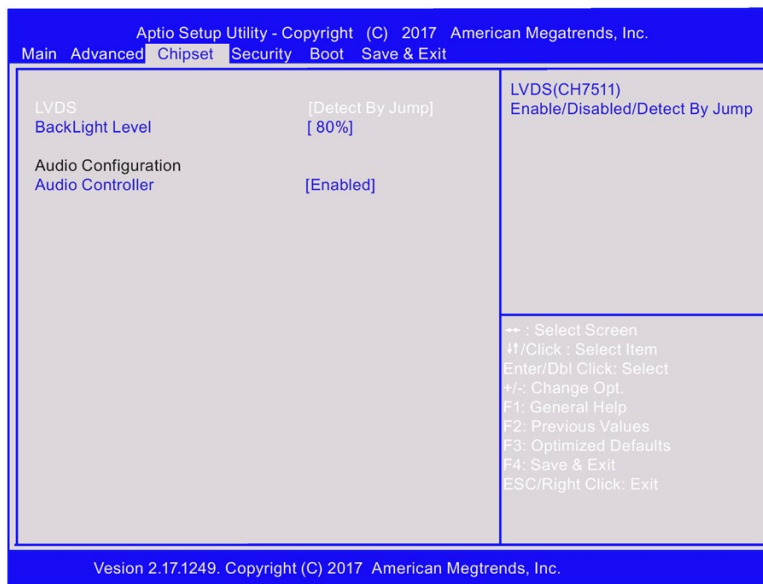

### LVDS

Follow the instructions below to enable or disable LVDS:

1. Select **LVDS** with the arrow keys and press **Enter** key.
2. Select **Enabled**, **Disabled** or **Detect By Jump** as you need and press **Enter** key in the active window pop-up.
3. When you select **Enabled**, for LVDS type, you can choose "1280\*800, 24bits, 60Hz" for 12" panel, choose "1366\*768, 24bits, 60Hz" for 15" and 19" panels.
4. Press **F4** key and save the change.

### Audio configuration

In Audio configuration page, you can view and configure Audio Controller.

1. Select **Audio Controller** with the arrow keys and press **Enter** key.
2. Select **Enabled** or **Disabled** as you want and press **Enter** key.
3. Press **F4** key and save the change.

## 8.6.5 Security setup

### Security setup

<p><b>NOTICE</b></p> <p><b>Risk of unauthorized modification for BIOS setting</b></p> <p>Everyone can access BIOS and change its setting if you don't set a password for BIOS.</p> <p>Modify the BIOS setting arbitrarily may interfere with device function.</p> <p>Set passwords for administrator and user. In this way to avoid unauthorized access and modification to BIOS.</p>
---

Security setup provides both Administrator and User password. If you want use both of these two passwords, the Administrator password must be set firstly. The Administrator and User passwords activate two different levels of password security.

After the passwords are set, you must enter a password every time when you enter BIOS.

Select **Security** menu item in BIOS Setup screen to enter Security setup screen. Security menu is shown below:

Aptio Setup Utility - Copyright (C) 2017 American Megatrends, Inc.

Main Advanced Chipset **Security** Boot Save & Exit

<p>Password Description</p> <p>If ONLY the Administrator's password is set, then this only limits access to Setup and is only asked for when entering Setup.</p> <p>If ONLY the User's password is set, then this is a power on password and must be entered to boot or enter Setup. In Setup the User will have Administrator rights.</p> <p>The password length must be in the following range:</p> <p>Minimum length                    3</p> <p>Maximum length                    20</p> <p>Administrator Password</p> <p>User Password</p>	<p>Set Administrator Password</p> <p>←→ : Select Screen          ↑/Click : Select Item          Enter/Dbl Click: Select          +/-: Change Opt.          F1: General Help          F2: Previous Values          F3: Optimized Defaults          F4: Save &amp; Exit          ESC/Right Click: Exit</p>
---	--

Vesion 2.17.1249. Copyright (C) 2017 American Megtrends, Inc.

### Administrator password

In the security setup page, you can set an administrator password level password for BIOS.

1. Select **Administrator Password** with the arrow keys and press **Enter** key.
2. Enter a password of at least three characters in length. The password can be up to 20 characters long and case-sensitive.
3. Re-enter the password when you are asked to confirm the password in the screen popped up.

### User password

In the security setup page, you can set a user level password for BIOS.

1. Select **User Password** with the arrow keys and press **Enter** key.
2. Enter a password of at least three characters in length. The password can be up to 20 characters long and case-sensitive.
3. Re-enter the password when you are asked to confirm the password in the screen popped up.

---

#### Note

Record the new password when the password is changed. If you forget the password, you must erase the system configuration information in NVRAM.

---

## 8.6.6 Boot Setup

### Boot Setup

Select **Boot** from the BIOS setup page to enter the boot setup page. The boot page is shown as below.

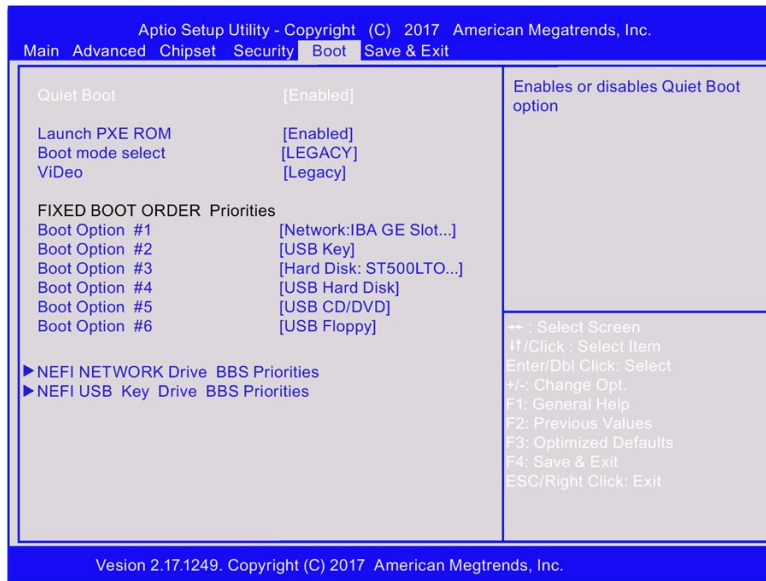

### Boot configuration

In the Boot configuration page, you can modify the boot up screen between POST message and SIEMENS logo.

#### Quiet Boot

Follow the steps below to select your boot-up screen.

1. Select **Quiet Boot** with the arrow keys and press **Enter** key.
2. Select the **Disabled** or **Enabled** as you want and press **Enter** key.
3. Press **F4** key and save the change.

See the quiet boot options below:

Option	Description
Disabled	Set the motherboard to display the POST message.
Enabled	Set the motherboard to display the SIEMENS logo. This is the default setting for Quiet boot.

---

**Note**

If quiet boot function is set as **Enabled** in BIOS, you can press TAB key to switch to POST message when the IPC is booting.

---

**Launch PXE ROM**

Follow the steps below to set the **PXE ROM**.

1. Select **Launch PXE ROM** with the arrow keys and press **Enter** key.
2. Select the **Disabled** or **Enabled** as you want and press **Enter** key.
3. Press **F4** key and save the change.

**Boot mode select**

Follow the steps below to select your boot-up screen.

1. Select **Boot mode select** with the arrow keys and press **Enter** key.
2. Select the **LEGACY** or **UEFI** as you want and press **Enter** key.

---

**Note**

Before installing Windows 10, set the boot mode as **UEFI** in BIOS.

---

3. Press **F4** key and save the change.

**Video**

Follow the steps below to select your boot-up screen.

1. Select **Video** with the arrow keys and press **Enter** key.
2. Select the **UEFI** or **Legacy** as you want and press **Enter** key.

---

**Note**

Before installing Windows 10, set the Video as **UEFI** in BIOS.

---

3. Press **F4** key and save the change.

**Set boot priority**

In set boot priority page, you can set the boot devices priority for all your boot devices.

Follow the steps below to set the boot devices priority.

1. Select boot priority you wish to change with the arrow keys and press **Enter** key.  
The option screen opens.
2. Select the device category and press **Enter** key .
3. Press **F4** key and save the change.

See the default priority for booting device below:

Boot priority	Device category
1 <sup>st</sup> boot	HDD/SSD
2 <sup>nd</sup> boot	USB-Key
3 <sup>rd</sup> boot	USB-FDD
4 <sup>th</sup> boot	USB-CD/DVD
5 <sup>th</sup> boot	USB-HDD
6 <sup>th</sup> boot	Network (PXE enable)

Once bootable devices are attached, the following items show up.

Bootable device	Description
Hard Disk Drive BBS Priorities	All the boot options that are configured as Hard Disk Drive are displayed in this page. You can change the priority as similar as changing the main boot option priorities. The 1st boot option has the highest boot priority and appears at the boot option priorities and boot order.
Floppy Drive BBS Priorities	You can set the system boot order for floppy drives in this field. The 1st boot option has the highest boot priority and appears at the boot option priorities and boot order.
CD/DVD ROM Drive BBS Priorities	You can set the system boot order for CD/DVD ROM drives in this field. The 1st boot option has the highest boot priority and appears at the boot option priorities and boot order.
USB Hard Disk Drive BBS Priorities	All the Boot options that are configured as USB Hard Disk Drive are displayed in this field. You can change the priority as similar to the main boot option priorities. The 1st boot option has the highest boot priority and appears at the boot option priorities and boot order.
USB Floppy Drive BBS Priorities	You can set the system boot order for USB floppy drives in this field. The 1st boot option has the highest boot priority and appears at the boot option priorities and boot order.
USB CD/DVD ROM Drive BBS Priorities	All the Boot options that are configured as USB CD/DVD ROM Drive are displayed in this field. You can change the priority as similar to the main boot option priorities. The 1st boot option has the highest boot priority and appears at the boot option priorities and boot order.

## 8.6.7 Save and Exit

### Save and exit

Select **Save & Exit** from the BIOS setup page to enter the save and exit page. The save and exit page is shown as below.

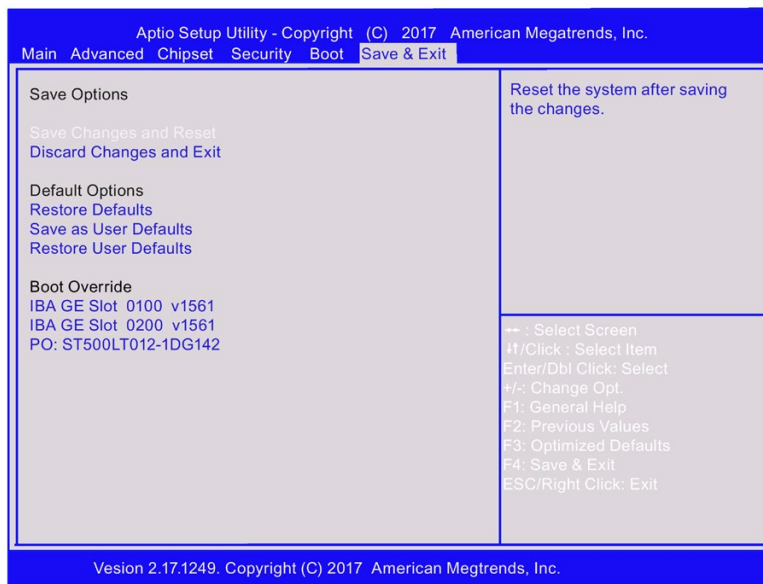

### Save Options

#### Save changes and reset

When you completed the system configuration changes, save the changes with the following instructions.

1. Select **Save Changes and Reset** with the arrow keys and press **Enter** key.
2. Select **Yes** and press **Enter** key to save changes and reset. Or Select **No** to quit the save.

After the system is rebooted, the new system configurations take effect.

#### Discard changes and reset

You can reboot the system without saving the changes with the following instructions.

1. Select **Discard Changes and Reset** with the arrow keys and press **Enter** key.
2. Select **Yes** and press **Enter** key to discard changes and reset. Or Select **No** to quit.



## Defaults Options

### Restore defaults

You can restore the system with the following instructions.

1. Select **Restore Defaults** with the arrow keys and press **Enter** key.
2. Select **Yes** and press **Enter** key to the load optimized defaults. Or Select **No** to quit.

### Save as user defaults

You can save your settings as user default settings with the following instructions.

1. Select **Save as User Defaults** with the arrow keys and press **Enter** key.
2. Select **Yes** and press **Enter** key to save the settings as user defaults. Or Select **No** to quit.

### Restore user defaults

You can restore the user default settings with the following instructions.

1. Select **Restore User Defaults** with the arrow keys and press **Enter** key.
2. Select **Yes** and press **Enter** key to load optimized defaults. Or Select **No** to quit.

## Boot override

All the available boot options are listed below the **Boot Override**. You can select any of the options to boot from a particular device.

# Appendix Motherboard

# A

## A.1 Jumpers



### WARNING

#### Electrostatic sensitive devices (ESD)

The motherboard contains electronic components which can be destroyed by electrostatic charges. This can result in malfunctions and damage to the machine or plant.

Always completely disconnect the power cord from your motherboard when you are working on it. Do not make connections while the power is on, because a sudden rush of power can damage the sensitive electronic components.

Always ground yourself to remove any static charge before touching the board. Modern electronic devices are very sensitive to static electric charges. Use a grounding wrist strap at all times. Place all electronic components on a static-dissipative surface or in a static-shielded bag when they are not in the chassis.

**⚠ WARNING**

**Improper operations on the motherboard may result in substantial damage to the motherboard or endanger the operator.**

- Do not remove or ruin the motherboard serial number labels. These labels and the serial numbers are required for warranty validation.
- Wear electrostatic discharge (ESD) wrist strap or gloves when handling or touching the motherboard.
- When handling the motherboard, avoid to touch any metal leads or connectors.
- Always unplug the AC power cord from the power outlet before you installing or removing the motherboard.
- Place the motherboard on an anti-static pad or in a electrostatic shielding container during the operation.
- Turn off the power supply before you removing the power supply cable from the motherboard.
- Before turning on the power supply, check if the input voltage setting follows the local voltage standard.
- Before operating the motherboard, make sure that the cables and the power connectors of all the attached hardware components are connected. Turning on the power before you connected them, the motherboard and the system components may get damaged and injure operator.
- Make sure you securely attached the hardware components to the motherboard connectors/ slots/ sockets.
- The screws are not allowed to connect with motherboard circuit or components. The motherboard can be get damaged by this action.
- Do not leave the screws or the metal components on the motherboard or inside of the chassis.

## Setting Jumpers

The board has a number of jumpers that allow you to configure. A jumper is a kind of electric switch. By setting jumpers, you can configure your card to match the needs of your application.

A jumper consists of two metal pins and a small metal clip (often protected by a plastic cover).

To connect the pins, lid the pin with the clip. To disconnect a jumper, remove the clip. Some jumpers have three pins, labeled 1, 2 and 3. In this case you can connect either pins 1 and 2 or 2 and 3.

A pair of needle nose pliers may be helpful when working with jumpers. If you have any questions about the best hardware configuration for you application, contact your local distributor or sales representative before you make any change.

**Clear COMS**

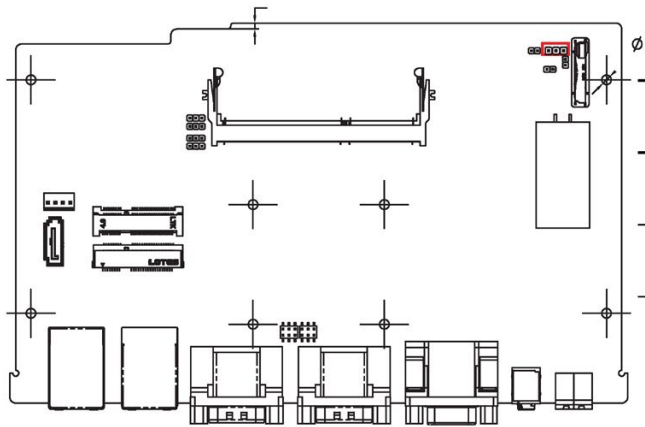

CLRTC1

Jumper position	Function
1-2	protected (default)
2-3	Clear COMS

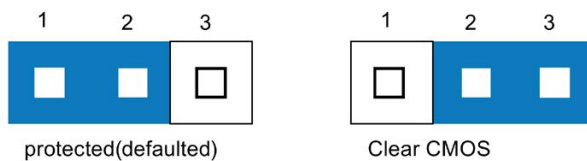

**Note**

Set the jumper back to protected mode after clearing CMOS.

**Jumper for COM port voltage setting**

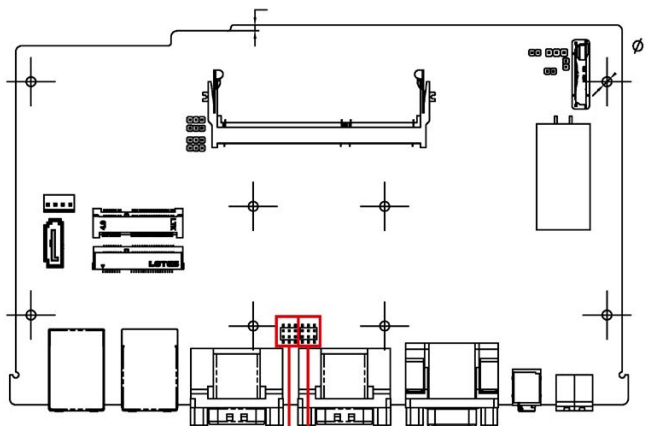

For COM2      For COM1

Jumper for COM port voltage setting

Jumper position	Function
1-2	+12V
3-4	+5V
5-6	RI (Default)

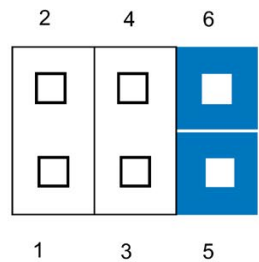

# Technical Support

## B.1 Service and support

You can find additional information and support for the products described on the Internet at the following addresses:

- Technical support  
(<https://support.industry.siemens.com/cs/start?lc=en-WW>)
- Support request form  
(<https://support.industry.siemens.com/My/ww/en/requests#createRequest>)
- After Sales Information System SIMATIC IPC/PG  
(<http://www.siemens.com/asis>)
- SIMATIC Documentation Collection  
(<http://www.siemens.com/simatic-tech-doku-portal>)
- Your local representative  
([http://w3.siemens.com/aspa\\_app/](http://w3.siemens.com/aspa_app/))
- Training center  
(<http://sitrain.automation.siemens.com/sitrainworld/?AppLang=en>)
- Industry Mall  
(<https://mall.industry.siemens.com>)

When contacting your local representative or Technical Support, please have the following information at hand:

- MLFB of the device
- BIOS version for industrial PC or image version of the device
- Other installed hardware
- Other installed software

### Tools & downloads

Please check regularly if updates and hotfixes are available for download to your device. The download area is available on the Internet at the following link:

After Sales Information System SIMATIC IPC/PG (<http://www.siemens.com/asis>)

## B.2 Problem solving

This section provides you with tips on how to locate and/or troubleshoot problems which occur.

Problem	Possible cause	Possible remedy
The device is not operational	No power supply	<ul style="list-style-type: none"> <li>• Check the power supply, the power cord and the power plug.</li> <li>• Check if the On/Off switch is in the correct position.</li> </ul>
	Device is being operated outside the specified ambient conditions	<ul style="list-style-type: none"> <li>• Check the ambient conditions.</li> <li>• After transport in cold weather, wait approximately 12 hours before switching on the device.</li> </ul>
The monitor remains dark	The brightness button has been set to dark	Increase brightness using the brightness button. For detailed information, refer to the monitor operating instructions.
	Power cord is not connected	<ul style="list-style-type: none"> <li>• Check whether the power cord has been properly connected to the monitor and to the system unit or to the grounded shockproof outlet.</li> </ul>
		If the monitor screen still remains dark after you have performed these checks and measures, contact your technical support team.
The mouse pointer does not appear on the screen	The mouse driver is not loaded	Check whether the mouse driver is properly installed and available when you start the user program. Detailed information about the mouse driver is available in the corresponding documentation.
	Mouse not connected	<ul style="list-style-type: none"> <li>• Check whether the mouse cord is properly connected to the system unit.</li> <li>• If you use an adapter or expansion for the mouse cable, also check these connectors.</li> </ul>
		If the mouse pointer still does not appear on the screen after you have performed these checks and actions, contact your technical support team.
Wrong time and/or date on the PC		<ol style="list-style-type: none"> <li>1. Open BIOS Setup.</li> <li>2. Set the time or date.</li> </ol>
Although the BIOS setting is OK, the time and data are still wrong.	The backup battery is dead.	Replace the backup battery.
USB device not responding.	The USB ports are not correctly supported.	<ul style="list-style-type: none"> <li>• Turn on USB Legacy Support for mouse and keyboard.</li> <li>• For other devices, you need the USB device drivers for the required operating system.</li> </ul>
"chkdsk" is not functioning	EFW (Enhanced Write Filter) has been activated. The "chkdsk" command is not supported if the EFW has been activated.	Deactivate the EFW or use an alternative method to "chkdsk".









## Markings and symbols

### C.1 Overview



The following tables show all the symbols which may be found on your SIMATIC industrial PC, SIMATIC industrial monitor or SIMATIC Field PG in addition to the symbols which are explained in the operating instructions.

The symbols on your device may vary in some details from the symbols shown in the following tables.

### C.2 Safety











Symbol	Meaning	Symbol	Meaning
	Warning, observe the supplied documentation.		Lock is closed
	Attention, radio equipment		Lock is open
	Disconnect the power plug before opening		Opening for Kensington lock
	Attention ESD (Electrostatic sensitive device)		Warning of hot surface

### C.3 Operator controls

Symbol	Meaning	Symbol	Meaning
	On/off switch, without electrical isolation		Eject CD/DVD
	On/off switch, without electrical isolation		















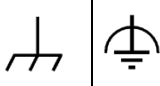



## C.4 Certificates, approvals and markings

The following table shows symbols relating to certificates, approvals and markings which may be on the device. You can find more information in the operating instructions for your device:

Symbol	Meaning	Symbol	Meaning
	Approved for Australia and New Zealand		Marking for the Eurasian Customs Union
	Approved for China		Test mark of Factory Mutual Research
	CE markings for European countries		Marking of Federal Communications Commission for the USA
	EFUP (Environment Friendly Use Period) marking for China		Approved for Korea
	Test mark of the Underwriters Laboratories		Disposal information, observe the local regulations.



## C.5 Interfaces

Symbol	Meaning	Symbol	Meaning
	Connection to the power supply		PS/2 mouse interface
	Protective conductor terminal		PS/2 keyboard-interface
	Connection for functional earthing (equipotential bonding line)		Multimedia Card Reader
DPP	DisplayPort interface		Smart Card Reader
	DVI-D interface		Line In
LAN 	LAN interface, not approved for connecting WAN or telephone		Line Out
	Serial port		Microphone input
	USB port		Universal Audio Jack
	USB 2.0 high-speed port		Headphone output
	USB 3.0 super-speed port		

# D

## List of abbreviations

AC	Alternating current	Alternating current
ACPI	Advanced Configuration and Power Interface	
AHCI	Advanced Host Controller Interface	Standardized controller interface for SATA devices. This is supported in Microsoft Windows XP as of SP1 and IAA driver.
APIC	Advanced Programmable Interrupt Controller	
AT	Advanced Technology	
ATA	Advanced Technology Attachment	
AWG	American Wire Gauge	A standardized wire gauge system. Used in North America and Canada.
BIOS	Basic Input Output System	
CAN	Controller Area Network	
CD-ROM	Compact Disc – Read Only Memory	
CE	Communauté Européenne	
CF	CompactFlash	
CMOS	Complementary Metal Oxide Semiconductors	
COA	Certificate of authentication	
COM	Communications Port	Term for the serial interface
CPU	Central Processing Unit	CPU
CSA	Canadian Standards Association	Canadian organization for tests and certifications according to national or binational standards
CTS	Clear To Send	Clear to send
DC	Direct Current	DC current
DCD	Data Carrier Detect	Data carrier signal detection
DMA	Direct Memory Access	
DOS	Disk Operating System	
DP	DisplayPort	
DQS	Deutsche Gesellschaft zur Zertifizierung von Qualitätsmanagement mBH	
DSR	Data Set Ready	Ready for operation
DTR	Data Terminal Ready	Data terminal is ready

DVD	Digital Versatile Disk	
ESD	Components sensitive to electrostatic charge	
EN	European standard	
EEPROM	Electrically Erasable Programmable Read-Only Memory	
ESD	Electrostatic Sensitive Device	Electrostatic Sensitive Devices
	Electrostatic discharge	Electrostatic discharge
EWF	Enhanced Write Filter	
FBWF	File Based Write Filter	
GND	Ground	Chassis ground
HD	Hard disk	Hard disk
HDD	Hard Disk Drive	HDD
HMI	Human Machine Interface	User interface
HORM	Hibernate Once - Resume Many	
HT	Hyper Threading	
I/O	Input/Output	Data input/output for computers
IDE	Integrated Device Electronics	
IEC	International Electrotechnical Commission	
IGD	Integrated Graphics Device	
IP	International Protection	Degree of protection
	in English-speaking countries: Ingress Protection	
IRQ	Interrupt Request	
ISA	Industry Standard Architecture	Bus for expansion modules
LAN	Local Area Network	Computer network that is limited to a local area.
LEDs	Light Emitting Diode	Light emitting diode
LPS	Limited Power Source	
MAC	Media access control	Media access control
MLFB	Machine-readable product designation	
MRAM	Magnetoresistive random-access memory	Backup memory
MS	Microsoft	
MTBF	Mean Time Between Failures	
MUI	Multilanguage User Interface	Language localization in Windows
NEMA	National Electrical Manufacturers Association	
NTFS	New Technology File System	
NVRAM	Non Volatile Random Access Memory	Non-volatile data memory. Data memory is retained without external power supply.
ODD	Optical Disk Drive	

PC	Personal computer	
PCI	Peripheral Component Interconnect	High-speed expansion bus
PCIe	Peripheral Component Interconnect express	High-speed serial, differential full-duplex PtP interface with high data rate.
PG	Programming device	
POST	Power On Self Test	
PXE	Preboot Execution Environment	Software for running new PCs without hard disk data via the network
RAID	Redundant Array of Independent Disks	Redundant hard disk array
RAL	Restricted Access Location	
RAM	Random Access Memory	
RI	Ring Input	Incoming call
ROM	Read-Only Memory	
RS 485	Reconciliation Sublayer 485	Bidirectional bus system
RTC	Real Time Clock	Real-time clock
RTS	Request to send	Request to send
RxD	Receive Data	Data transfer signal
SATA	Serial Advanced Technology Attachment	
SCU	Setup Configuration Utility	
SELV	Safety Extra Low Voltage	Safety extra low voltage
SMART	Self Monitoring Analysis and Reporting Technology	Hard disk error diagnostics program
SRAM	Static Random Access Memory	Static RAM
SSD	Solid State Drive	
TFT	Thin-Film-Transistor	
TxD	Transmit Data	Data transfer signal
UEFI	Unified Extensible Firmware Interface	
UL	Underwriters Laboratories Inc.	US organization for testing and certification according to national or binational standards.
USB	Universal Serial Bus	
VDE	Verband der Elektrotechnik, Elektronik und Informationstechnik e.V (Association for Electrical, Electronic and Information Technologies)	
VT	Virtualization Technology	Intel technology which provides a virtual, closed environment.

VT-d	Virtualization Technology for Directed I/O	Enables the direct assignment of a device (e.g. network adapter) to a virtual device.
WD	Watchdog	Program monitoring with error detection and alarming.

# Glossary

## AHCI mode

AHCI is a standardized method to address the SATA controller. AHCI describes a structure in the RAM, which contains a general area for control and status, as well as a command list.

## APIC mode

Advanced peripheral interrupt controller. 24 interrupt lines are available.

## Automation system

A programmable controller (PLC) of the SIMATIC S7 system consist of a central controller, one or several CPUs, and various I/O modules.

## Backup

Duplicate of a program, data medium or database, used either for archiving purposes or for the protection of vital and non-replaceable data against loss when the working copy is corrupted. Certain applications automatically generate backup copies of data files, and manage both the current and the previous versions on the hard disk.

## Baud

Physical unit for the step speed in signal transmission. Defines the number of transferred signal states per second. With only two states, one baud is equivalent to a transmission rate of 1 bps.

## Cache

High-speed access buffer for interim storage (buffering) of requested data.

## CE marking

Communauté Européene: The CE symbol confirms the conformity of the product with all applicable EC directives such as the EMC Directive.

## CFast

The faster SATA protocol is used with the CFast standard for memory cards based on CompactFlash. The connectors on these cards are not compatible with a classic CompactFlash card.

**Chipset**

Located on the motherboard, connects the processor with the PCI or PCIe bus and the external interfaces.

**Cold restart**

A start sequence, starting when the computer is switched on. The system usually performs some basic hardware checks within the cold start sequence, and then loads the operating system from the hard disk to work memory -> boot

**COM interface**

The COM interface is a serial V.24 interface. The interface is suitable for asynchronous data transfer.

**CompactFlash card**

CompactFlash is a digital storage medium in card format and without moving parts. The CF card contains the non-volatile memory and the controller. The interface of the CF card corresponds with the IDE interface. CF cards can be operated without additional electronics on PCMCIA or IDE hard disk controllers using a plug and socket adapter. There are two design forms: CF-I (42.6 x 36.4 x 3.3 mm) and CF-II (42.8 x 36.4 x 5 mm).

**Configuration files**

These are files containing data which define the configuration after restart. Examples of such files are CONFIG.SYS, AUTOEXEC.BAT and the registry files .

**Configuration software**

The configuration software updates the device configuration when new modules are installed . This is done either by copying the configuration files supplied with the module or by manual configuration using the configuration utility.

**Controller**

Integrated hardware and software controllers that control the functions of certain internal or peripheral devices (for example, the keyboard controller).

**Device configuration**

The configuration of a PC or programming device contains information on hardware and device options, such as memory configuration, drive types, monitor, network address, etc. The data are stored in a configuration file and enable the operating system to load the correct device drivers and configure the correct device parameters. . If changes are made to the hardware configuration, the user can change entries in the configuration file using the SETUP program. .

## Drivers

Program parts of the operating system. They adapt user program data to the specific formats required by I/O devices such as hard disk, printers, and monitors.

## EMC directive

Directive concerning **Electromagnetic Compatibility**. Compliance is confirmed by the CE symbol and the EC certificate of conformity.

## Energy management

The energy management functions of a modern PC allow individual control over the current consumption of vital computer components (e.g. of the monitor, hard disk and CPU), by restricting their activity based on the current system or component load. Energy management is of particular importance for mobile PCs.

## Energy options

The energy options can be used to reduce energy consumption of the computer, while keeping it ready for immediate use. This can be configured in Windows by selecting Settings > Control Panel > Energy options.

## Enhanced Write Filter

Configurable write filter that allows you to, for example, boot Windows Embedded Standard from write-protected media (e.g., CD-ROM), set write protection for individual partitions, and adapt the file system performance to user requirements (when using memory cards, for example).

## ESD Guideline

Guideline for using electrostatic sensitive components.

## Ethernet

Local network (bus structure) for text and data communication with a transfer rate of 10/100/1000 Mbps.

## Execute Disable Capability

Hardware implementation that prevents mutual memory accesses by programs and applications. It is only effective when all relevant system components, such as processors, operating systems and applications are supported.



**Extensible Firmware Interface**

Refers to the central interface between the firmware, the individual components of a computer and the operating system. EFI is located logically below the operating system and represents the successor to PC BIOS, focusing on 64-bit systems.

**File Based Write Filter**

Configurable write filter to protect individual files from write access.

**Formatting**

Basic partitioning of memory space on a magnetic data medium into tracks and segments. Formatting deletes all data on a data medium. All data media must be formatted prior to their first use.

**HORM**

Hibernate once, resume many is a method for fast booting from a single Hibernate file that only needs to be created once. HORM ensures restoration of a uniform, saved system state when booting. This minimizes write access, for example to a memory card, when you start up and shut down Windows Embedded Standard 7.

**Hub**

A term in network technology. In a network, a device joining communication lines at a central location, providing a common connection to all devices on the network.

**Hyper Threading**

HT technology (multi-threading) enables the parallel computing of processes. HT is only effective when all relevant system components, such as processors, operating systems and applications are supported.

**IGD**

Integrated Graphics Device. Graphics interface integrated in the chipset.

**Image**

This refers to the image, for example, of hard disk partitions saved to a file in order to restore them when necessary.

**Intel Active Management Technology**

This technology permits diagnostics, management and remote control of PCs. It is only effective when all relevant system components, such as processors, operating systems and applications are supported.

## Intel VT

The Intel Virtualization Technology (IVT) is the implementation of a secure closed environment for applications. Special (visualization) software on a VT-capable processor is required for its use.

## Interface

- Physical interconnection (cable) of hardware elements such as PLCs, PCs, programming devices, printers or monitors.
- Interface for interactive software applications.

## LAN

**Local Area Network:** LAN is a local network that consists of a group of computers and other devices that are distributed across a relatively restricted range and are linked with communication cables. The devices connected to a LAN are called nodes. The purpose of networks is the mutual use of files, printers or other resources.

## Legacy Boot Device

Conventional drives can be used as USB devices.

## License key

The license key represents the electronic license stamp of a license. Siemens AG issues a license key for each software that is protected by a license.

## License key USB flash drive

The license key USB flash drive contains the authorizations or license keys required to enable protected SIMATIC software.

## Low-voltage directive

EC Product Safety Directive relating to the safety of products which are operated on low voltage (50 V AC to 1000 V AC, 70 V DC to 1500 V DC) and not specified in other directives. Compliance is confirmed by the CE symbol and the EC certificate of conformity.

## Module

Modules are plug-in units for PLCs, programming devices or PCs. They are available as local modules, expansion modules, interfaces or mass storage (Mass storage module).

## Motherboard

The motherboard is the core of the computer. Here, data are processed and stored, and interfaces and device I/Os are controlled and managed.

**Operating system**

Generic term which describes all functions for controlling and monitoring user program execution, distribution of system resources to the user programs and the operating mode in cooperation with the hardware (for example, Windows 7 Ultimate).

**Pixel**

The pixel represents the smallest element that can be reproduced on-screen or on a printer.

**Plug&Play**

Generally, a reference to the ability of a computer to automatically configure the system for communication with peripheral devices (for example monitors, modems or printers). The user can plug in a peripheral and "play" it at once without manually configuring the system. A Plug&Play PC requires both a BIOS that supports Plug&Play and a Plug&Play expansion card.

**POST**

Self-test performed by the BIOS after the computer is switched on. Performs a RAM test and a graphics controller test, for example. The system outputs audible signals (beep codes) if the BIOS detects any errors; the relevant message indicating cause of error is output on the screen.

**Programmable controller**

The programmable controllers of the SIMATIC S7 system consist of a central controller, one or more CPUs, and various other modules (e.g. I/O modules).

**PXE server**

A **Preboot Execution Environment** server is part of a network environment and can provide software to connected computers even before they boot. This can involve operating system installations or servicing tools, for example.

**RAL**

**Restricted Access Location**: Installation of the device in a production facility with restricted access, for example, a locked control cabinet.

**Recovery DVD**

Contains the tools for configuring hard disks and the Windows operating system.

**Reset**

Hardware reset: Reset/restart of the PC using a button/switch.

## **Restart**

Warm restart of a computer without switching the power off (Ctrl + Alt + Del)

## **Restore DVD**

The Restore DVD is used to restore the system partition or the entire hard disk to delivery state if the system has crashed. The DVD contains all the necessary image files and is bootable.

## **ROM**

Read-Only Memory ROM is a read-only memory in which every memory location can be addressed individually. The programs or data are permanently stored and are not lost in the event of a power failure.

## **S.M.A.R.T**

Self-Monitoring, Analysis and Reporting Technology (SMART or S.M.A.R.T.) is an industry standard integrated in storage media. It makes for permanent monitoring of important parameters and early detection of imminent problems.

## **SATA**

Serial ATA Interface for hard disk drives and optical drives with serial data transmission rates of up to 300 Mbps.

## **SETUP (BIOS Setup)**

A program in which information about the device configuration (that is the configuration of the hardware on the PC/PG) is defined. The device configuration of the PC/PG is preset with defaults. Changes must therefore be entered in the SETUP if a memory expansion, new modules or a new drive are added to the hardware configuration.

## **SSD (Solid State Drive)**

A Solid State Drive is a drive that can be installed like any other drive; it does not contain a rotating disk or other moving parts because only semiconductor memory chips of similar capacity will be used. This design makes SSDs more rugged, provides shorter access times, low energy consumption and rapid data transfer.

## **STEP 7**

Programming software for the creation of user programs for SIMATIC S7 controllers.

## **Troubleshooting**

Error cause, cause analysis, remedy

### **Trusted Execution Technology**

Hardware implementation that allows secured execution of programs and applications. It is only effective when all relevant system components, such as processors, operating systems and applications are supported.

### **Wake on LAN**

Wake on Local area network. This function allows the PC to be started via the LAN interface.

### **Warm restart**

The restart of a computer after a program was aborted. The operating system is loaded and restarted again. The CTRL+ ALT+ DEL hotkey can be used to initiate a warm restart.

# Index

## A

Antivirus software, 37  
Approval, (EAC)

## B

Backup battery  
  Installing, 49  
BSMI, 58

## C

Canada, 57  
Certificates  
  Certifications and approvals, 56  
chkdsk, 94  
Cleaning Agents, 48  
COA label, 19, 19  
Components sensitive to electrostatic charge, 59  
Condensation, 18  
Connecting  
  function earth, 31  
  Network, 32  
Connecting the function earth, 31

## D

Data exchange, 32  
DC power supply, 68  
Degree of protection, 21, 65  
Device  
  Closing, 43  
  Mounting, 26  
  Opening, 41  
Directive  
  ESD Directive, 59  
Display, 16  
  Size, 8  
DisplayPort  
  Interface, 72  
Drive, 66

## E

EAC, 58  
ESD, 59  
ESD Directive, 59  
Ethernet, 32, 69  
External interfaces, 69

## F

FCC, 57  
Fire protection covering, 23  
Fire protection enclosure, 23  
Firewall, 37  
function earth, 30, 30  
  Connecting, 30

## H

Hardware reset, 36

## I

Identification data, 18  
Industrial Ethernet, 33  
Initial commissioning, 34  
Installation guidelines, 23  
Installation information, 23  
Installing  
  Backup battery, 49  
  Drive, 50  
  PCIe plug-in card, 44  
Integration  
  Ethernet, 32  
  Industrial Ethernet, 33  
  PROFINET, 33  
Interface, 66  
Interfaces  
  DisplayPort, 72  
  USB 2.0, 71  
  USB 3.0, 71  
IT communication, 32

**K**

Korea Certificate, 58

**L**

Limitation of liability, 47

**M**

Memory medium, 66  
 Motherboard  
   External interfaces, 69  
   Technical features, 69  
 Mounting  
   Mounting clip, 24  
 Mounting clip  
   Installing, 24  
 Mounting cutout  
   Dimensions, 22  
   Preparing, 22  
 Mounting positions, 20

**N**

Note, 23  
   General Information, 15  
   Installation guidelines, 23

**O**

Operating system  
   Initial commissioning, 34  
   Shutdown, 35  
 Operation  
   Touch screen, 39, 40

**P**

Package contents, 17  
   Checking, 17  
 Packaging, 17  
   Checking, 17  
   Removing, 17  
 PCIe plug-in card  
   Installing, 44  
 Pixel, 16  
   Defective pixel, 16

Power supply

  DC power supply, 68  
   Power requirements of auxiliary components, 68

Product label, 19

PROFINET, 33

Protective measure

  Static electricity, 61

**R**

Radiation, 14  
   High frequency radiation, 14  
 Real-time protection, 37  
 Repairs, 46, 47

**S**

Safety information  
   Storage, 18  
   Transportation, 18  
 SIMATIC NET, 33  
 SIMATIC S7, 32  
   Integration, 32  
 Static electricity  
   Protective measures, 61  
 Switching off the device  
   Disconnect from mains voltage, 36  
   Shutting down the operating system, 35  
 System resources, 74  
   Currently allocated system resources, 74

**T**

Tools, 47  
 Touch screen  
   Operation, 39, 40

**U**

USB, 69  
 USB 2.0  
   Port, 71  
 USB 3.0  
   Interface, 71

**W**

Warranty, 13  
 Windows Security Center, 37

