

CIRCUIT BREAKER 3VA6 UL FRAME 250 BREAKING CAPACITY CLASS H 65KA @ 480V 4-POLE, LINE PROTECTION ETU820, LI, IN=250A OVERLOAD PROTECTION IR=100A ...250A SHORT CIRCUIT PROTECTION II=1,5...10 X IN W/O CONNECTION



Model	
Product brand name	SENTRON
Product designation	Molded-case circuit breaker
Design of the product	System protection
Design of the load switch / acc. to UL 489 / Heating, Air Conditioning, and Refrigeration circuit breaker (HACR Type)	Yes
Design of the overcurrent release	ETU820
Protective function of the overcurrent release	LI
Number of poles	4
General technical data	
Tension assignée d'isolement Ui	600 V
Max. rated operational voltage Ue with AC 50/60Hz	600 V
Active power loss / for rated value of the current / at AC / in hot operating state / per device	42 W
Active power loss / for rated value of the current / at AC / in hot operating state / per pole	14 W
Mechanical service life (switching cycles) / typical	20 000

Electrical endurance (switching cycles) / at AC-1 / at 380/415 V 50/60 Hz	6 000
Electrical endurance (switching cycles) / at AC-1 / at 690 V 50/60 Hz	3 000
Electrical endurance (switching cycles) / at 480 V / at 50/60 Hz	6 000
Electrical endurance (switching cycles) / at 600 V / at 50/60 Hz	7 500
Neutral conductors / upgradeable/retrofitable	No
Ground fault monitoring version	Without
Product function	
• communication function	Yes
• other measurement function	Yes

Electricity

Marking / acc. to UL 489 / 100%-rated breaker	No
Max. rated operational voltage of the size of the circuit-breaker	250 A
Courant permanent assigné lu	250 A
Operating current	
• at 40 °C	250 A
• at 45 °C	250 A
• at 50 °C	250 A
• at 55 °C	250 A
• at 60 °C	250 A
• at 65 °C	245 A
• at 70 °C	277 A

Switching capacity according to IEC 60947

Switching capacity class of the circuit breaker	H
Maximum short-circuit current breaking capacity (I _{cu})	
• at 240 V	110 kA
• at 415 V	85 kA
• at 690 V	3 kA
Operational short-circuit current breaking capacity (I _{cs})	
• at 240 V	110 kA
• at 415 V	85 kA
• at 690 V	3 kA
Short-circuit current making capacity (I _{cm})	
• at 240 V	242 kA
• at 415 V	187 kA
• at 690 V	4.5 kA

Switching capacity according to UL 489

Breaking capacity current	
<ul style="list-style-type: none"> • at 240 V • at 480 Y/277 V • at 480 V • at 600 Y/347 V 	100 kA 65 kA 65 kA 22 kA

Adjustable parameters

Adjustable response value current / I _g min.	100 A
Adjustable response value current / I _g min.	250 A
Adjustable response value current / I _g min.	0.5
Adjustable response value current / I _g min.	13
Adjustable response value current / I _i min.	375 A
Adjustable response value current / I _i max.	2 500 A
Ground fault protection / tripping switchable / I _{2t} =ON/OFF	No

Mechanical Design

Height [in]	7.8 in
Height	198 mm
Width [in]	5.5 in
Width	140 mm
Depth [in]	3.4 in
Depth	86 mm

Connections

Arrangement of electrical connectors / for main current circuit	Without connection
Type of electrical connection / for main current circuit	Without

Auxiliary circuit

Number of CO contacts / for auxiliary contacts	0
--	---

Accessories







Product extension / optional / motor drive	Yes
--	-----

Environmental conditions

Protection class IP / on the front	IP40
Ambient temperature	
<ul style="list-style-type: none"> • during operation / minimum • during operation / maximum • during storage / minimum • during storage / maximum 	-25 °C 70 °C -40 °C 80 °C

Certificates

Equipment marking / acc. to DIN EN 81346-2	Q
Certificate of suitability / as approval for NAVAL (no combat vessels) / Supplement SB	No

General Product Approval		EMC	Declaration of Conformity	Shipping Approval	
 CSA	 UL		 RCM	 EG-Konf.	 ABS

other

[Miscellaneous](#)

Further information

Information- and Downloadcenter (Catalogs, Brochures,...)

<http://www.siemens.com/lowvoltage/catalogs>

Industry Mall (Online ordering system)

<https://mall.industry.siemens.com/mall/en/en/Catalog/product?mlfb=3VA6225-6KL41-0AA0>

Service&Support (Manuals, Certificates, Characteristics, FAQs,...)

<https://support.industry.siemens.com/cs/ww/en/ps/3VA6225-6KL41-0AA0>

Image database (product images, 2D dimension drawings, 3D models, device circuit diagrams, ...)

http://www.automation.siemens.com/bilddb/cax_en.aspx?mlfb=3VA6225-6KL41-0AA0

CAX-Online-Generator

<http://www.siemens.com/cax>

Tender specifications

<http://www.siemens.com/specifications>

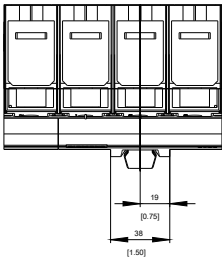
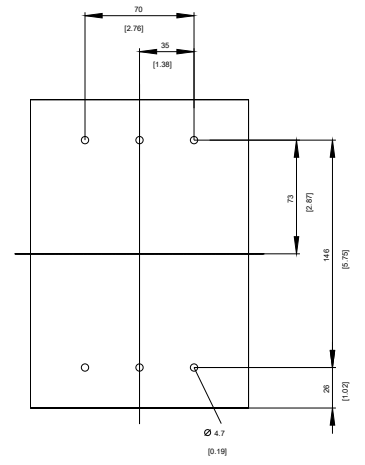
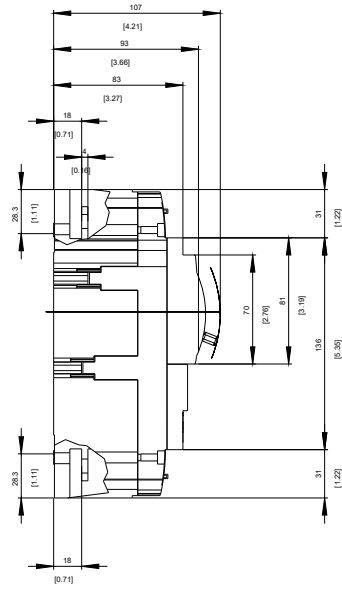
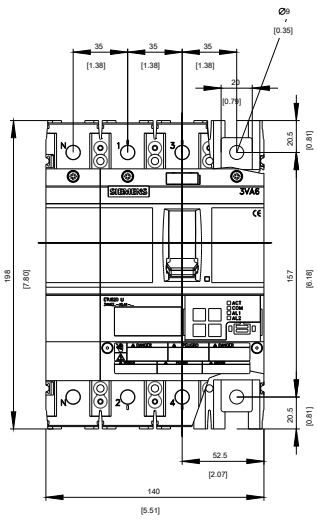

-Q

SIEMENS

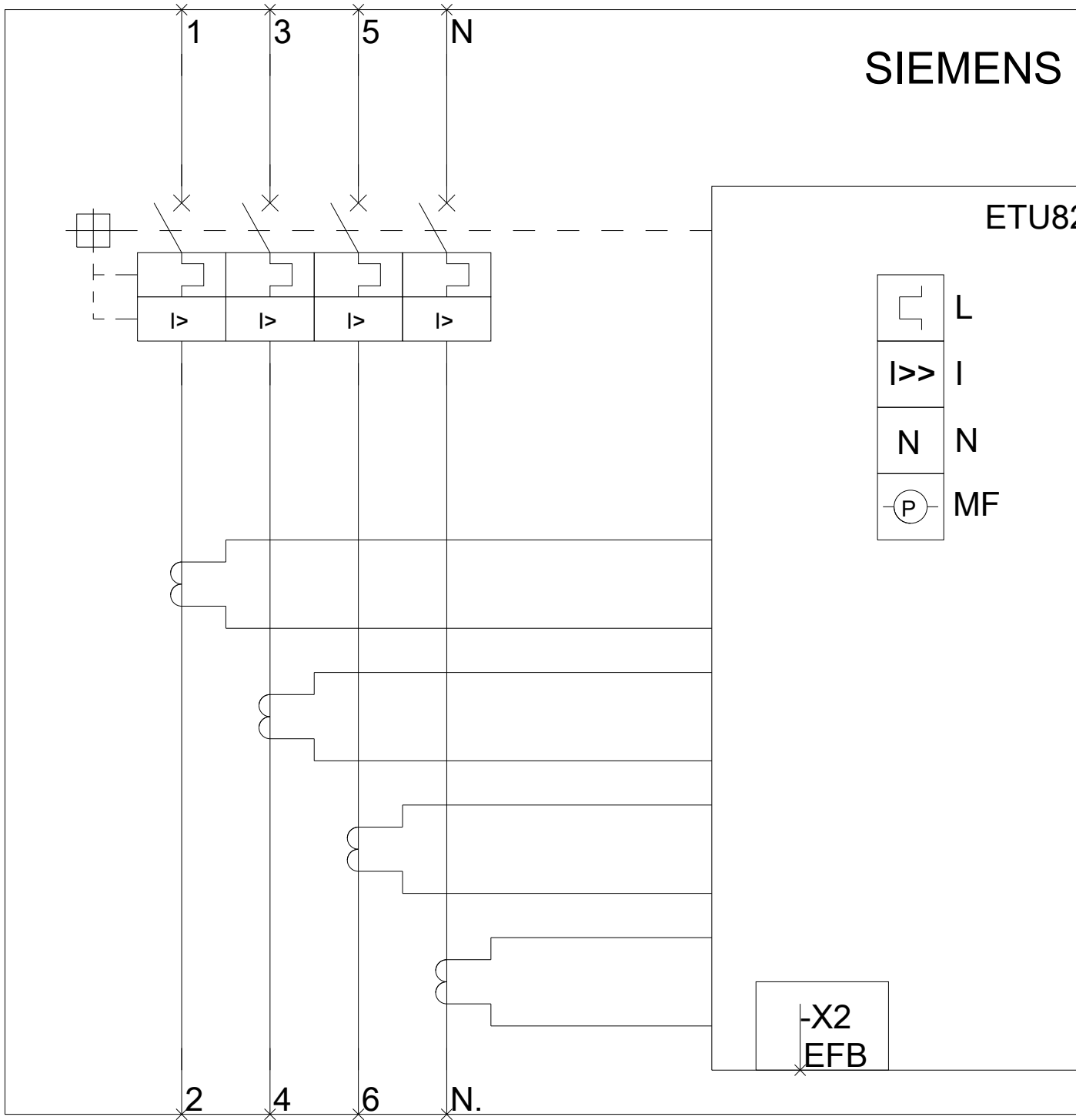

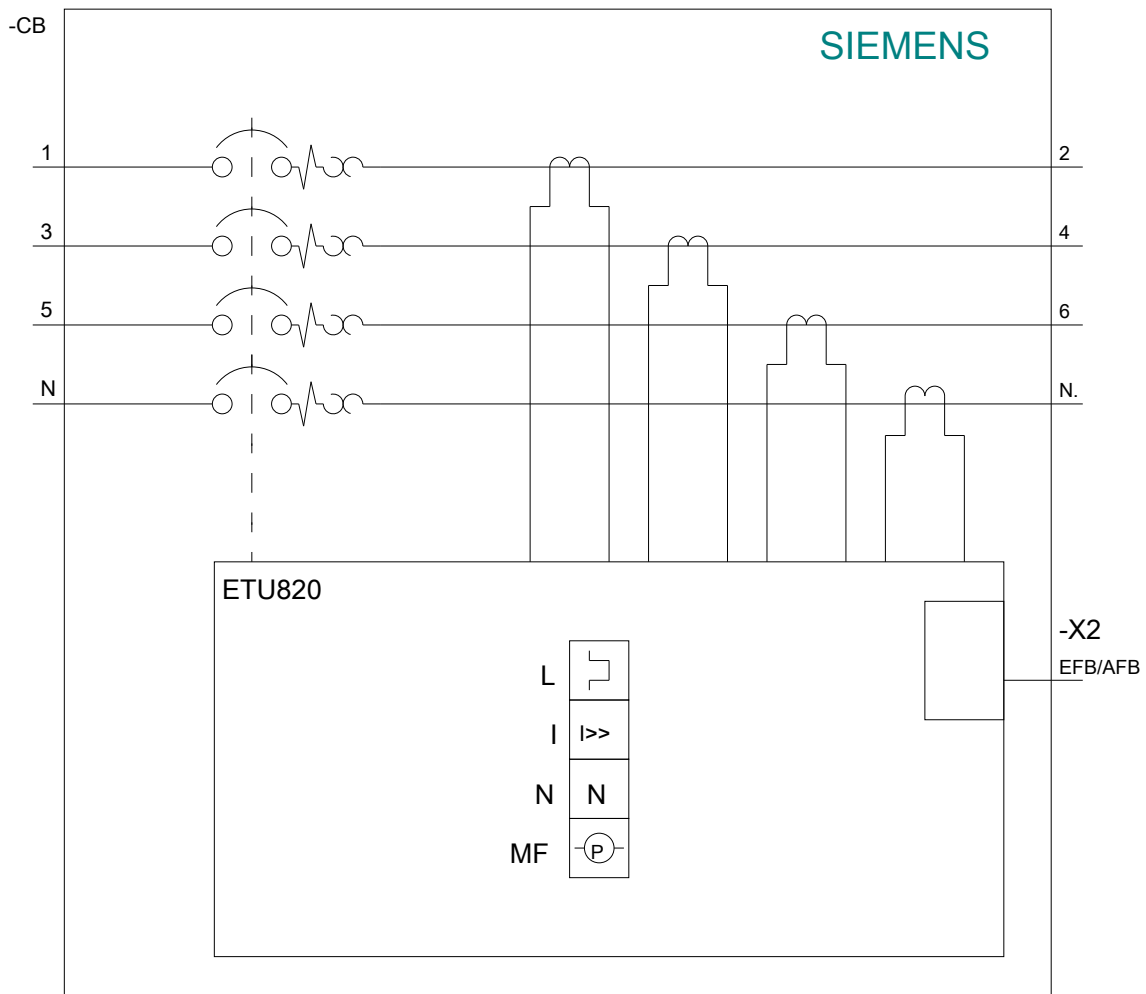

last modified:

09/15/2017