



Mechanically latched lighting contactor
400 Amp
3NO / 0NC Poles
Maximum voltage rating 600VAC
Control voltage 208VAC 60Hz
NEMA Type 12 enclosure

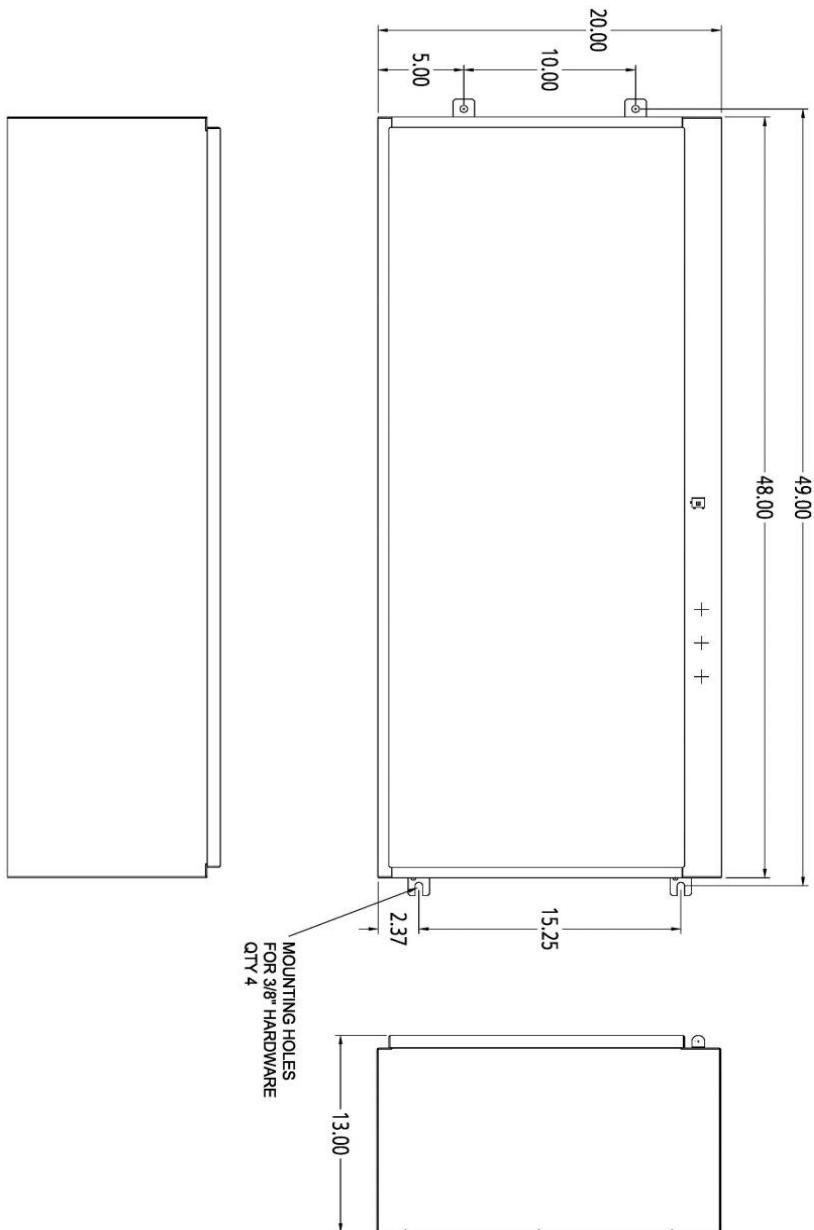

Image is representative and may not depict the actual product.

General technical data:	
Weight	145 lb
Height x Width x Depth	48 x 20 x 13 in.
Finger-safe (main circuit / control circuit)	NA / NA
Maximum altitude	6560 ft
Ambient storage temperature	(no data)
Ambient operating temperature	(no data)
Humidity (% non-condensing)	(no data)
Country of origin	USA
Contactors:	
Number of poles	3NO / 0NC
Mechanical operating cycles	600,000
Current ratings:	
Tungsten (poles per phase)	400A @277V 1p 1ph
	400A @480V 2p 1ph
	400A @480V 3p 3ph
Ballast (poles per phase)	400A @347V 1p 1ph
	400A @600V 2p 1ph
	400A @600V 3p 3ph
General & resistive (poles per phase)	400A @347V 1p 1ph
	400A @600V 2p 1ph
	400A @600V 3p 3ph
Internal/standard auxiliary contact:	
Number of NC / NO auxiliary contacts	0NC / 0NO
Rating	NA
Optional auxiliary contact:	
Max number of NC / NO auxiliary contacts	4 max NC/NO combination
Rating	10A@600VAC (A600), 1A@300VDC (R300)
Coil:	
Voltage	208V 60Hz Coil
Sealed watts	(no data)
Inrush / sealed power	1600 / 550 VA
Normal coil operating limits (% of rated voltage)	85% - 110%
Typical drop-out volts (% of rated voltage)	(no data)
Pick-up time / Drop-out time	(no data)
Disconnect type (none):	
Rating	NA
Fuse type accepted	NA

Enclosure:	
Type	NEMA Type 12 enclosure
Rating	Dust tight and drip proof for indoors
Mounting/wiring:	
Mounting orientation	Vertical
Mounting type	Surface
Line side connection type / torque	Box lug / 275 - 300 lb-in.
Line side solid & stranded conductors	2 x (2 AWG - 350 kcmil) 75°C AL or CU
Load side connection type / torque	Box lug / 275 - 300 lb-in.
Load side solid & stranded conductors	2 x (2 AWG - 350 kcmil) 75°C AL or CU
Coil connection type / torque	Screw / 8 - 12 lb in.
Coil solid & stranded conductors	2 x (16 - 12 AWG) CU 75°C
Main auxiliary contact connection type / torque	NA
Main auxiliary contact solid & stranded conductors	NA
Short circuit current rating:	
Fuses	none
Thermal magnetic circuit breaker	10kA@600V (400A max CB)
Additional information:	
	Brochure

OUTLINE 48X20X13 NEMA 4/12



DIMENSIONS ARE IN INCHES.
FILE NAME: SFS-D65608009-0211

Wiring Diagram Class CLM 300 & 400 Amp 2 & 3 Pole

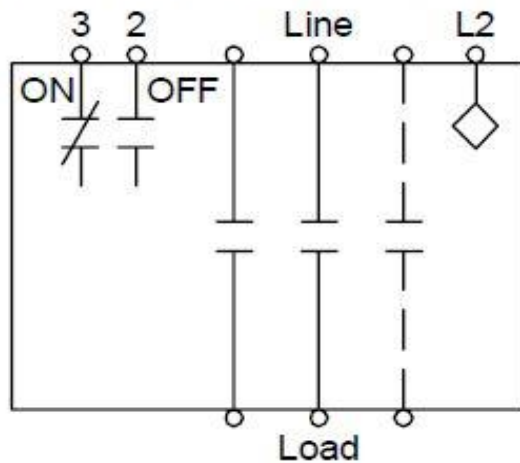

Notes:

1. Dotted line represents third pole.
Contactor may have 2 or 3 poles.
2. Optional auxiliary contacts are not shown.