

back view

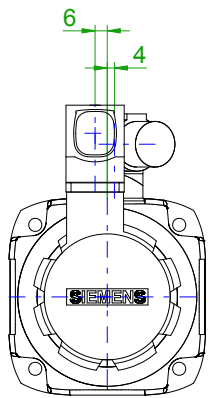

front view

center hole
DIN 332-DR M6

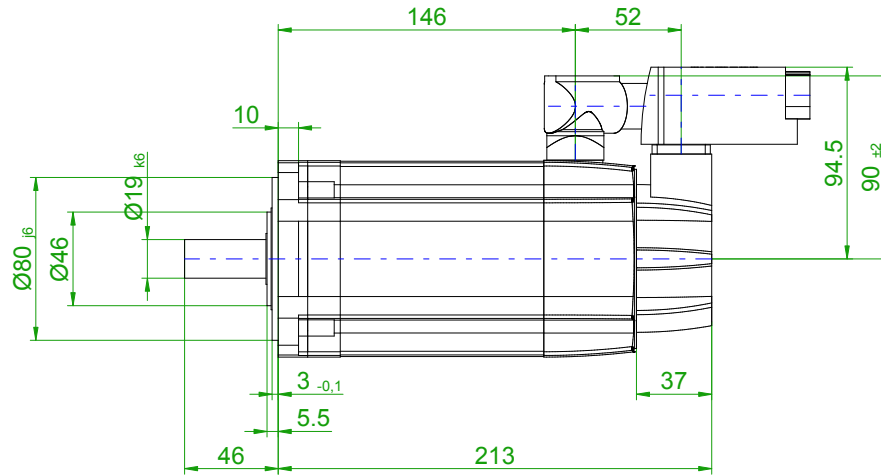
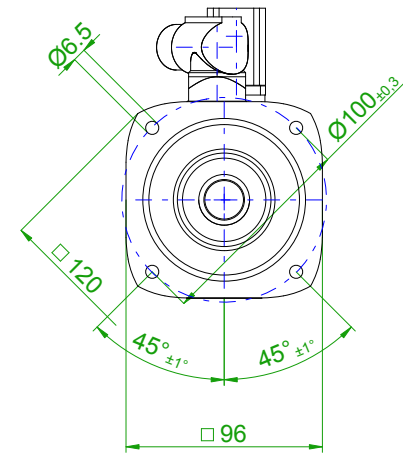

6-pole plug size 1
for power

10-pole
signal plug

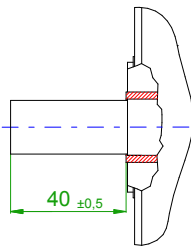
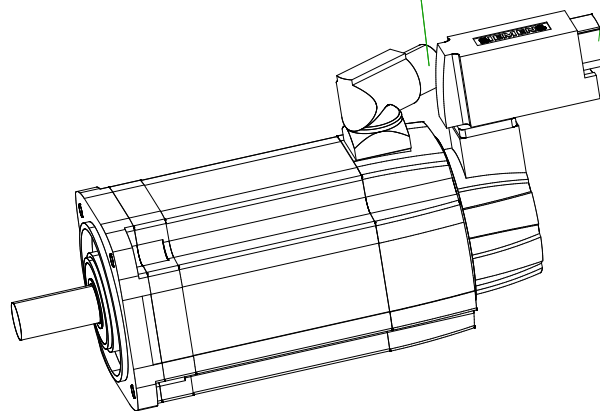

rotating angle of the plug

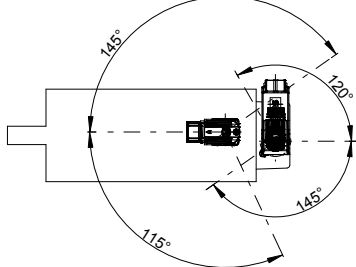

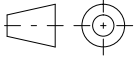
		SIEMENS	
Einheit / unit: mm		Synchron-Servomotor Synchronous Servo Motor:	1FT7044-5AF70-1FG2
nicht tolerierte Maße / not toleranced dimensions: ±1		Optionen / options:	
Maßstab / scale: ohne / without		Gewicht / mass:	7.2 kg
CAD CREATOR 2.2 (WWW-Version V02.20.00.00)		Bemerkung / notice:	
		Druckdatum / print date:	13.02.2020