

SIRIUS ACT: Terminal module (LED module), integrated LED yellow, for front plate mounting



| | |
|--------------------------|---------------------|
| Product brand name | SIRIUS ACT |
| Product designation | Terminal module |
| Design of the product | with integrated LED |
| Product type designation | 3SU1 |

| Display | |
|--|-----|
| Display version | |
| <ul style="list-style-type: none"> for diagnostic function: Supply voltage monitoring Power LED | Yes |
| <ul style="list-style-type: none"> status Tx/Rx link | No |

| General technical data | |
|---|--|
| Product function | |
| <ul style="list-style-type: none"> Reverse polarity protection | Yes; Ribbon cable can be rotated 180°. |
| <ul style="list-style-type: none"> Diagnostics function | Yes |
| Firmware version | 1.0.0 |
| Hardware version | 1 |
| Software version with STEP 7 in the TIA Portal required | V13 SP1 (V13 SP1 and V14 with HSP0132) |
| Power loss [W] typical | 0.115 W |
| Degree of pollution | 3 |

| | |
|--|--------|
| Type of voltage | |
| • of the operating voltage | DC |
| • of the input voltage | DC |
| Surge voltage resistance rated value | 0.8 kV |
| Consumed current | |
| • maximum | 27 mA |
| • Rated value | 23 mA |
| Protection class IP | IP20 |
| Reference code acc. to DIN EN 81346-2 | K |

Communication/ Protocol

| | |
|------------------------------|----|
| Protocol is supported | |
| • PROFI-safe protocol | No |

Connections/ Terminals

| | |
|---|---|
| Type of electrical connection | Insulation displacement connection |
| Type of connectable conductor cross-sections | Ribbon cable 7-pole, 7 x 0.08 mm ² |
| Connectable conductor cross-section for auxiliary contacts | |
| • single or multi-stranded | 0.08 ... 0.08 mm ² |
| • finely stranded with core end processing | 0.08 mm ² |
| Connectable conductor cross-section | |
| • solid | 0.08 ... 0.08 mm ² |
| • solid with core end processing | 0.08 ... 0.08 mm ² |
| • finely stranded with core end processing | 0.08 ... 0.08 mm ² |
| • finely stranded without core end processing | 0.08 ... 0.08 mm ² |
| AWG number as coded connectable conductor cross section | 28 ... 28 |

Lamp

| | |
|----------------------------------|--------|
| Color of the light source | yellow |
|----------------------------------|--------|

Safety related data

| | |
|-----------------------------|------|
| Service life maximum | 20 y |
|-----------------------------|------|

Ambient conditions

| | |
|--|--|
| Environmental category during operation acc. to IEC 60721 | 3M6, 3S2, 3B2, 3K6 (with relative air humidity of 10 ... 95 %, no condensation in operation permitted) |
| Explosion protection marking for intrinsic safety of related equipment EEx ia | No |
| Explosion protection marking for intrinsic safety of related equipment EEx ib | No |



Installation/ mounting/ dimensions

| | |
|--|------------------|
| Mounting type of modules and accessories | Snap-on mounting |
| Height | 32.6 mm |
| Width | 30 mm |

Depth

31.5 mm

Certificates/ approvals

| General Product Approval | Declaration of Conformity | Test Certificates | other |
|---|---|---|---|
|  UL |  |  EG-Konf. | Miscellaneous Type Test Certificates/Test Report Confirmation |

Further information

Information- and Downloadcenter (Catalogs, Brochures,...)

www.siemens.com/sirius/catalogs

Industry Mall (Online ordering system)

<https://mall.industry.siemens.com/mall/en/en/Catalog/product?mlfb=3SU1401-1ME30-1DA1>

Cax online generator

<http://support.automation.siemens.com/WW/CAXorder/default.aspx?lang=en&mlfb=3SU1401-1ME30-1DA1>

Service&Support (Manuals, Certificates, Characteristics, FAQs,...)

<https://support.industry.siemens.com/cs/ww/en/ps/3SU1401-1ME30-1DA1>

Image database (product images, 2D dimension drawings, 3D models, device circuit diagrams, EPLAN macros, ...)

http://www.automation.siemens.com/bilddb/cax_de.aspx?mlfb=3SU1401-1ME30-1DA1&lang=en

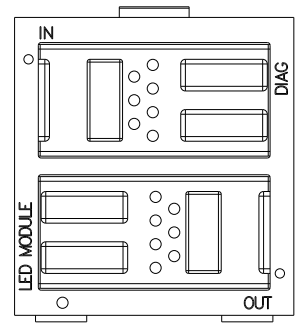
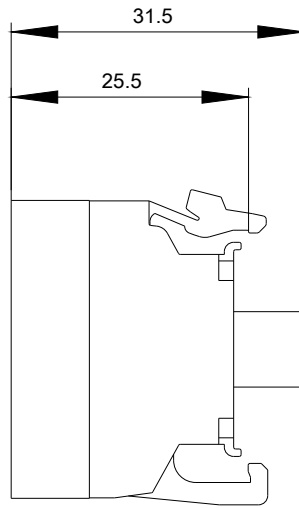
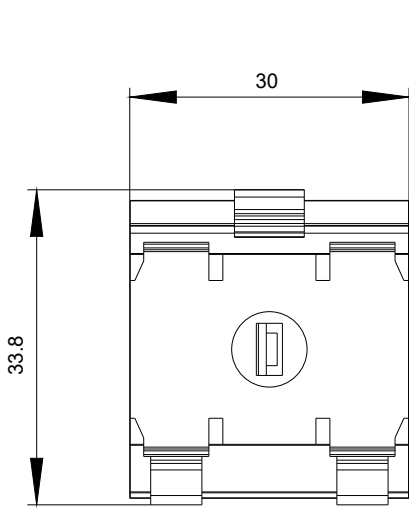

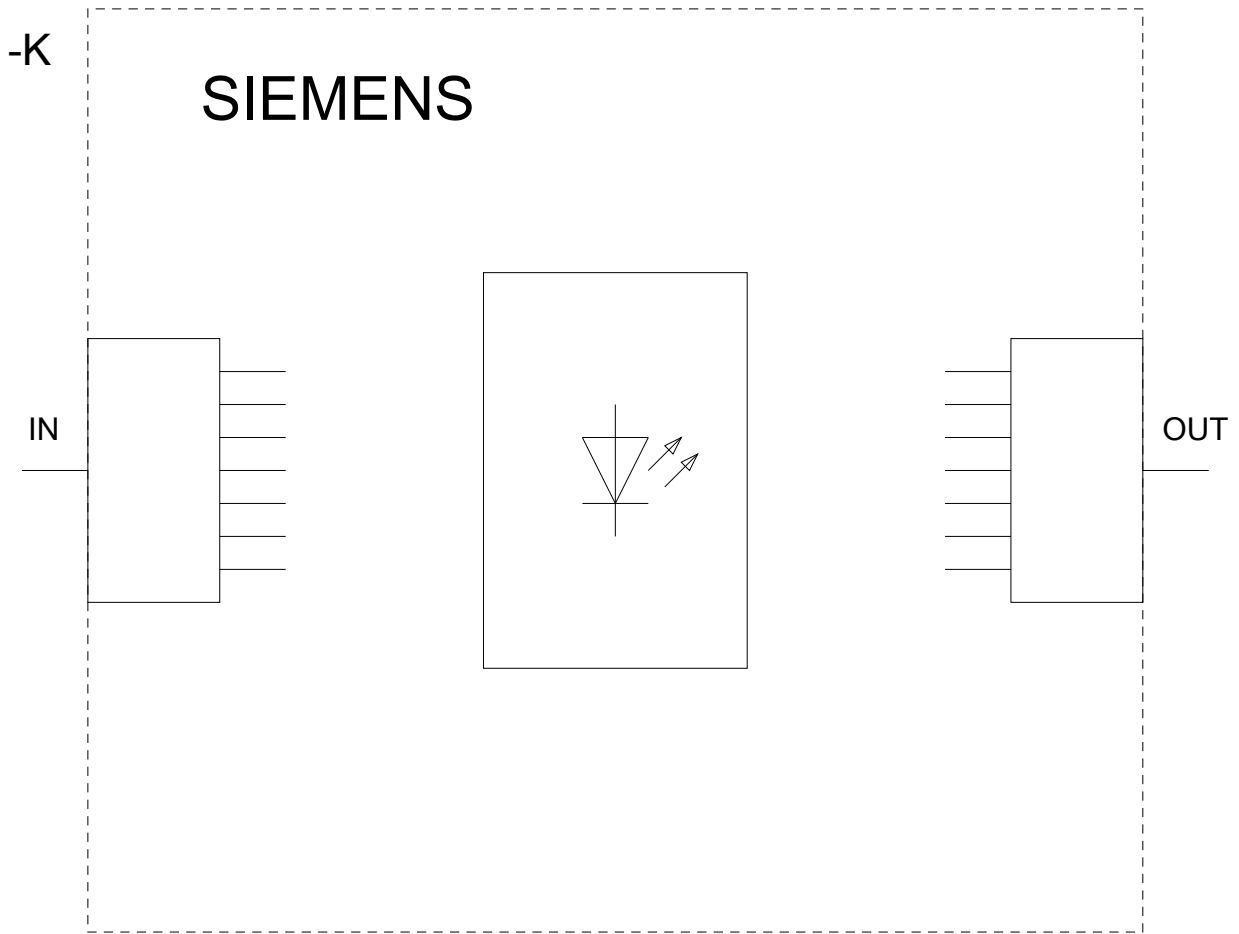

last modified:

10/30/2019