

power contactor, AC-3 12 A, 5.5 kW / 400 V 1 NC, 24 V DC 0.7-1.25\*US with integrated suppressor diode 3-pole, Size S00 screw terminal suitable for PLC outputs



Product brand name	SIRIUS
Product designation	Coupling relay
Product type designation	3RT2

General technical data	
Size of contactor	S00
Product extension	
<ul style="list-style-type: none"> <li>function module for communication</li> </ul>	No
<ul style="list-style-type: none"> <li>Auxiliary switch</li> </ul>	No
Power loss [W] for rated value of the current	
<ul style="list-style-type: none"> <li>at AC in hot operating state</li> </ul>	3.6 W
<ul style="list-style-type: none"> <li>at AC in hot operating state per pole</li> </ul>	1.2 W
Power loss [W] for rated value of the current without load current share typical	2.8 W
Surge voltage resistance	
<ul style="list-style-type: none"> <li>of main circuit rated value</li> </ul>	6 kV
<ul style="list-style-type: none"> <li>of auxiliary circuit rated value</li> </ul>	6 kV
maximum permissible voltage for safe isolation	
<ul style="list-style-type: none"> <li>between coil and main contacts acc. to EN 60947-1</li> </ul>	400 V

<b>Protection class IP</b>	
• on the front	IP20
• of the terminal	IP20
<b>Shock resistance at rectangular impulse</b>	
• at DC	7.3g / 5 ms, 4.7g / 10 ms
<b>Shock resistance with sine pulse</b>	
• at DC	11,4g / 5 ms, 7,3g / 10 ms
<b>Mechanical service life (switching cycles)</b>	
• of contactor typical	30 000 000
<b>Reference code acc. to DIN 40719 extended according to IEC 204-2 acc. to IEC 750</b>	K
<b>Reference code acc. to DIN EN 81346-2</b>	Q

### Ambient conditions

<b>Installation altitude at height above sea level</b>	
• maximum	2 000 m
<b>Ambient temperature</b>	
• during operation	-25 ... +60 °C
• during storage	-55 ... +80 °C

### Main circuit

<b>Number of poles for main current circuit</b>	3
<b>Number of NO contacts for main contacts</b>	3
<b>Operating voltage</b>	
• at AC-3 rated value maximum	690 V
<b>Operating current</b>	
• at AC-1 at 400 V	
— at ambient temperature 40 °C rated value	22 A
• at AC-1	
— up to 690 V at ambient temperature 40 °C rated value	22 A
— up to 690 V at ambient temperature 60 °C rated value	20 A
• at AC-2 at 400 V rated value	12 A
• at AC-3	
— at 400 V rated value	12 A
— at 500 V rated value	9.2 A
— at 690 V rated value	6.7 A
• at AC-4 at 400 V rated value	8.5 A
• at AC-5a up to 690 V rated value	19.4 A
• at AC-5b up to 400 V rated value	9.9 A
• at AC-6a	
— up to 230 V for current peak value n=20 rated value	7.2 A

— up to 400 V for current peak value n=20 rated value	7.2 A
— up to 500 V for current peak value n=20 rated value	7.2 A
— up to 690 V for current peak value n=20 rated value	6.7 A
• at AC-6a	
— up to 230 V for current peak value n=30 rated value	4.8 A
— up to 400 V for current peak value n=30 rated value	4.8 A
— up to 500 V for current peak value n=30 rated value	4.8 A
— up to 690 V for current peak value n=30 rated value	4.8 A
<b>Minimum cross-section in main circuit</b>	
• at maximum AC-1 rated value	4 mm <sup>2</sup>
<b>Operating current for approx. 200000 operating cycles at AC-4</b>	
• at 400 V rated value	4.1 A
• at 690 V rated value	3.3 A
<b>Operating current</b>	
• at 1 current path at DC-1	
— at 24 V rated value	20 A
— at 110 V rated value	2.1 A
— at 220 V rated value	0.8 A
— at 440 V rated value	0.6 A
— at 600 V rated value	0.6 A
• with 2 current paths in series at DC-1	
— at 24 V rated value	20 A
— at 110 V rated value	12 A
— at 220 V rated value	1.6 A
— at 440 V rated value	0.8 A
— at 600 V rated value	0.7 A
• with 3 current paths in series at DC-1	
— at 24 V rated value	20 A
— at 110 V rated value	20 A
— at 220 V rated value	20 A
— at 440 V rated value	1.3 A
— at 600 V rated value	1 A
<b>Operating current</b>	
• at 1 current path at DC-3 at DC-5	
— at 24 V rated value	20 A

<ul style="list-style-type: none"> <li>— at 110 V rated value</li> <li>• with 2 current paths in series at DC-3 at DC-5 <ul style="list-style-type: none"> <li>— at 24 V rated value</li> <li>— at 110 V rated value</li> </ul> </li> <li>• with 3 current paths in series at DC-3 at DC-5 <ul style="list-style-type: none"> <li>— at 24 V rated value</li> <li>— at 110 V rated value</li> <li>— at 220 V rated value</li> <li>— at 440 V rated value</li> <li>— at 600 V rated value</li> </ul> </li> </ul>	<p>0.1 A</p> <p>20 A</p> <p>0.35 A</p> <p>20 A</p> <p>20 A</p> <p>1.5 A</p> <p>0.2 A</p> <p>0.2 A</p>
<b>Operating power</b>	
<ul style="list-style-type: none"> <li>• at AC-1 <ul style="list-style-type: none"> <li>— at 230 V rated value</li> <li>— at 230 V at 60 °C rated value</li> <li>— at 400 V rated value</li> <li>— at 400 V at 60 °C rated value</li> <li>— at 690 V rated value</li> <li>— at 690 V at 60 °C rated value</li> </ul> </li> <li>• at AC-2 at 400 V rated value</li> <li>• at AC-3 <ul style="list-style-type: none"> <li>— at 230 V rated value</li> <li>— at 400 V rated value</li> <li>— at 500 V rated value</li> <li>— at 690 V rated value</li> </ul> </li> </ul>	<p>7.5 kW</p> <p>7.5 kW</p> <p>13 kW</p> <p>13 kW</p> <p>22 kW</p> <p>22 kW</p> <p>5.5 kW</p> <p>3 kW</p> <p>5.5 kW</p> <p>5.5 kW</p> <p>5.5 kW</p>
<b>Operating power for approx. 200000 operating cycles at AC-4</b>	
<ul style="list-style-type: none"> <li>• at 400 V rated value</li> <li>• at 690 V rated value</li> </ul>	<p>2 kW</p> <p>2.5 kW</p>
<b>No-load switching frequency</b>	
<ul style="list-style-type: none"> <li>• at DC</li> </ul>	10 000 1/h
<b>Operating frequency</b>	
<ul style="list-style-type: none"> <li>• at AC-1 maximum</li> <li>• at AC-2 maximum</li> <li>• at AC-3 maximum</li> <li>• at AC-4 maximum</li> </ul>	<p>1 000 1/h</p> <p>750 1/h</p> <p>750 1/h</p> <p>250 1/h</p>
<b>Control circuit/ Control</b>	
<b>Type of voltage of the control supply voltage</b>	DC
<b>Control supply voltage at DC</b>	
<ul style="list-style-type: none"> <li>• rated value</li> </ul>	24 V
<b>Operating range factor control supply voltage rated value of magnet coil at DC</b>	

<ul style="list-style-type: none"> <li>• initial value</li> </ul>	0.7
<ul style="list-style-type: none"> <li>• Full-scale value</li> </ul>	1.25
<b>Design of the surge suppressor</b>	with suppressor diode
<b>Closing power of magnet coil at DC</b>	2.8 W
<b>Holding power of magnet coil at DC</b>	2.8 W
<b>Closing delay</b>	
<ul style="list-style-type: none"> <li>• at DC</li> </ul>	30 ... 100 ms
<b>Opening delay</b>	
<ul style="list-style-type: none"> <li>• at DC</li> </ul>	7 ... 13 ms
<b>Arcing time</b>	10 ... 15 ms
<b>Control version of the switch operating mechanism</b>	Standard A1 - A2

### Auxiliary circuit

<b>Number of NC contacts for auxiliary contacts</b>	
<ul style="list-style-type: none"> <li>• instantaneous contact</li> </ul>	1
<b>Operating current at AC-12 maximum</b>	10 A
<b>Operating current at AC-15</b>	
<ul style="list-style-type: none"> <li>• at 230 V rated value</li> </ul>	10 A
<ul style="list-style-type: none"> <li>• at 400 V rated value</li> </ul>	3 A
<ul style="list-style-type: none"> <li>• at 500 V rated value</li> </ul>	2 A
<ul style="list-style-type: none"> <li>• at 690 V rated value</li> </ul>	1 A
<b>Operating current at DC-12</b>	
<ul style="list-style-type: none"> <li>• at 24 V rated value</li> </ul>	10 A
<ul style="list-style-type: none"> <li>• at 48 V rated value</li> </ul>	6 A
<ul style="list-style-type: none"> <li>• at 60 V rated value</li> </ul>	6 A
<ul style="list-style-type: none"> <li>• at 110 V rated value</li> </ul>	3 A
<ul style="list-style-type: none"> <li>• at 125 V rated value</li> </ul>	2 A
<ul style="list-style-type: none"> <li>• at 220 V rated value</li> </ul>	1 A
<ul style="list-style-type: none"> <li>• at 600 V rated value</li> </ul>	0.15 A
<b>Operating current at DC-13</b>	
<ul style="list-style-type: none"> <li>• at 24 V rated value</li> </ul>	10 A
<ul style="list-style-type: none"> <li>• at 48 V rated value</li> </ul>	2 A
<ul style="list-style-type: none"> <li>• at 60 V rated value</li> </ul>	2 A
<ul style="list-style-type: none"> <li>• at 110 V rated value</li> </ul>	1 A
<ul style="list-style-type: none"> <li>• at 125 V rated value</li> </ul>	0.9 A
<ul style="list-style-type: none"> <li>• at 220 V rated value</li> </ul>	0.3 A
<ul style="list-style-type: none"> <li>• at 600 V rated value</li> </ul>	0.1 A
<b>Contact reliability of auxiliary contacts</b>	1 faulty switching per 100 million (17 V, 1 mA)

### UL/CSA ratings

<b>Full-load current (FLA) for three-phase AC motor</b>	
<ul style="list-style-type: none"> <li>• at 480 V rated value</li> </ul>	11 A
<ul style="list-style-type: none"> <li>• at 600 V rated value</li> </ul>	11 A

<b>Yielded mechanical performance [hp]</b>	
<ul style="list-style-type: none"> <li>• for single-phase AC motor <ul style="list-style-type: none"> <li>— at 110/120 V rated value</li> <li>— at 230 V rated value</li> </ul> </li> <li>• for three-phase AC motor <ul style="list-style-type: none"> <li>— at 200/208 V rated value</li> <li>— at 220/230 V rated value</li> <li>— at 460/480 V rated value</li> <li>— at 575/600 V rated value</li> </ul> </li> </ul>	<p>0.5 hp</p> <p>2 hp</p> <p>3 hp</p> <p>3 hp</p> <p>7.5 hp</p> <p>10 hp</p>
<b>Contact rating of auxiliary contacts according to UL</b>	A600 / Q600

### Short-circuit protection

<b>Design of the fuse link</b>	
<ul style="list-style-type: none"> <li>• for short-circuit protection of the main circuit <ul style="list-style-type: none"> <li>— with type of coordination 1 required</li> <li>— with type of assignment 2 required</li> </ul> </li> <li>• for short-circuit protection of the auxiliary switch required</li> </ul>	<p>gG: 50A (690V,100kA), aM: 20A (690V,100kA), BS88: 35A (415V,80kA)</p> <p>gG: 20A (690V,100kA), aM: 16A (690V, 100kA), BS88: 20A (415V, 80kA)</p> <p>gG: 10 A (500 V, 1 kA)</p>

### Installation/ mounting/ dimensions

<b>Mounting position</b>	+/-180° rotation possible on vertical mounting surface; can be tilted forward and backward by +/- 22.5° on vertical mounting surface
<b>Mounting type</b>	screw and snap-on mounting onto 35 mm standard mounting rail according to DIN EN 60715
<ul style="list-style-type: none"> <li>• Side-by-side mounting</li> </ul>	Yes
<b>Height</b>	58 mm
<b>Width</b>	45 mm
<b>Depth</b>	73 mm
<b>Required spacing</b>	
<ul style="list-style-type: none"> <li>• with side-by-side mounting <ul style="list-style-type: none"> <li>— forwards</li> <li>— upwards</li> <li>— downwards</li> <li>— at the side</li> </ul> </li> <li>• for grounded parts <ul style="list-style-type: none"> <li>— forwards</li> <li>— upwards</li> <li>— at the side</li> <li>— downwards</li> </ul> </li> <li>• for live parts <ul style="list-style-type: none"> <li>— forwards</li> </ul> </li> </ul>	<p>10 mm</p> <p>10 mm</p> <p>10 mm</p> <p>0 mm</p> <p>10 mm</p> <p>10 mm</p> <p>6 mm</p> <p>10 mm</p> <p>10 mm</p>

— upwards	10 mm
— downwards	10 mm
— at the side	6 mm

## Connections/ Terminals





<b>Type of electrical connection</b>	
<ul style="list-style-type: none"> <li>• for main current circuit</li> <li>• for auxiliary and control current circuit</li> <li>• at contactor for auxiliary contacts</li> <li>• of magnet coil</li> </ul>	<p>screw-type terminals</p> <p>screw-type terminals</p> <p>Screw-type terminals</p> <p>Screw-type terminals</p>
<b>Type of connectable conductor cross-sections</b>	
<ul style="list-style-type: none"> <li>• for main contacts <ul style="list-style-type: none"> <li>— solid</li> <li>— single or multi-stranded</li> <li>— finely stranded with core end processing</li> </ul> </li> <li>• at AWG conductors for main contacts</li> </ul>	<p>2x (0.5 ... 1.5 mm<sup>2</sup>), 2x (0.75 ... 2.5 mm<sup>2</sup>), 2x 4 mm<sup>2</sup></p> <p>2x (0,5 ... 1,5 mm<sup>2</sup>), 2x (0,75 ... 2,5 mm<sup>2</sup>), 2x 4 mm<sup>2</sup></p> <p>2x (0.5 ... 1.5 mm<sup>2</sup>), 2x (0.75 ... 2.5 mm<sup>2</sup>)</p> <p>2x (20 ... 16), 2x (18 ... 14), 2x 12</p>
<b>Connectable conductor cross-section for main contacts</b>	
<ul style="list-style-type: none"> <li>• solid</li> <li>• stranded</li> <li>• finely stranded with core end processing</li> </ul>	<p>0.5 ... 4 mm<sup>2</sup></p> <p>0.5 ... 4 mm<sup>2</sup></p> <p>0.5 ... 2.5 mm<sup>2</sup></p>
<b>Connectable conductor cross-section for auxiliary contacts</b>	
<ul style="list-style-type: none"> <li>• single or multi-stranded</li> <li>• finely stranded with core end processing</li> </ul>	<p>0.5 ... 4 mm<sup>2</sup></p> <p>0.5 ... 2.5 mm<sup>2</sup></p>
<b>Type of connectable conductor cross-sections</b>	
<ul style="list-style-type: none"> <li>• for auxiliary contacts <ul style="list-style-type: none"> <li>— single or multi-stranded</li> <li>— finely stranded with core end processing</li> </ul> </li> <li>• at AWG conductors for auxiliary contacts</li> </ul>	<p>2x (0,5 ... 1,5 mm<sup>2</sup>), 2x (0,75 ... 2,5 mm<sup>2</sup>), 2x 4 mm<sup>2</sup></p> <p>2x (0.5 ... 1.5 mm<sup>2</sup>), 2x (0.75 ... 2.5 mm<sup>2</sup>)</p> <p>2x (20 ... 16), 2x (18 ... 14), 2x 12</p>
<b>AWG number as coded connectable conductor cross section</b>	
<ul style="list-style-type: none"> <li>• for main contacts</li> <li>• for auxiliary contacts</li> </ul>	<p>20 ... 12</p> <p>20 ... 12</p>



## Safety related data

<b>B10 value</b>	
<ul style="list-style-type: none"> <li>• with high demand rate acc. to SN 31920</li> </ul>	1 000 000
<b>Proportion of dangerous failures</b>	
<ul style="list-style-type: none"> <li>• with low demand rate acc. to SN 31920</li> <li>• with high demand rate acc. to SN 31920</li> </ul>	<p>40 %</p> <p>73 %</p>
<b>Failure rate [FIT]</b>	
<ul style="list-style-type: none"> <li>• with low demand rate acc. to SN 31920</li> </ul>	100 FIT

Product function	Yes
• Mirror contact acc. to IEC 60947-4-1	
T1 value for proof test interval or service life acc. to IEC 61508	20 y
Protection against electrical shock	finger-safe

### Certificates/ approvals

General Product Approval	EMC
 CCC	 CSA
 UL	 EAC
	 RCM

Functional Safety/Safety of Machinery	Declaration of Conformity	Test Certificates	Marine / Shipping
<a href="#">Type Examination Certificate</a>	 EG-Konf.	<a href="#">Miscellaneous</a> <a href="#">Type Test Certificates/Test Report</a> <a href="#">Special Test Certificate</a>	 ABS

 BUREAU VERITAS	 LRS	 PRS	 RINA	 RMRS	 TYPE APPROVED PRODUCT DNV-GL DNVGL.COM/AF
---	--	--	---	---	--

other	Railway
<a href="#">Confirmation</a>	<a href="#">Special Test Certificate</a>
 VDE	

### Further information

Information- and Downloadcenter (Catalogs, Brochures,...)

[www.siemens.com/sirius/catalogs](http://www.siemens.com/sirius/catalogs)

Industry Mall (Online ordering system)

<https://mall.industry.siemens.com/mall/en/en/Catalog/product?mlfb=3RT2017-1KB42>

Cax online generator

<http://support.automation.siemens.com/WW/CAXorder/default.aspx?lang=en&mlfb=3RT2017-1KB42>

Service&Support (Manuals, Certificates, Characteristics, FAQs,...)

<https://support.industry.siemens.com/cs/ww/en/ps/3RT2017-1KB42>

Image database (product images, 2D dimension drawings, 3D models, device circuit diagrams, EPLAN macros, ...)

[http://www.automation.siemens.com/bilddb/cax\\_de.aspx?mlfb=3RT2017-1KB42&lang=en](http://www.automation.siemens.com/bilddb/cax_de.aspx?mlfb=3RT2017-1KB42&lang=en)

Characteristic: Tripping characteristics, I<sup>t</sup>, Let-through current

<https://support.industry.siemens.com/cs/ww/en/ps/3RT2017-1KB42/char>

Further characteristics (e.g. electrical endurance, switching frequency)

<http://www.automation.siemens.com/bilddb/index.aspx?view=Search&mlfb=3RT2017-1KB42&objecttype=14&gridview=view1>

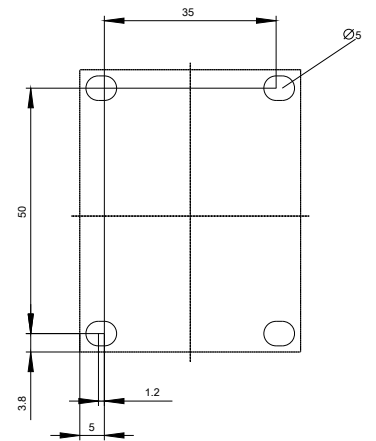
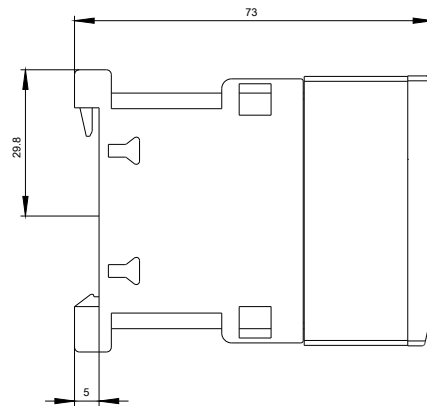
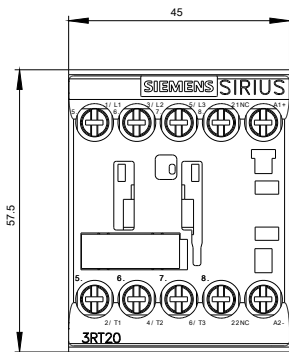

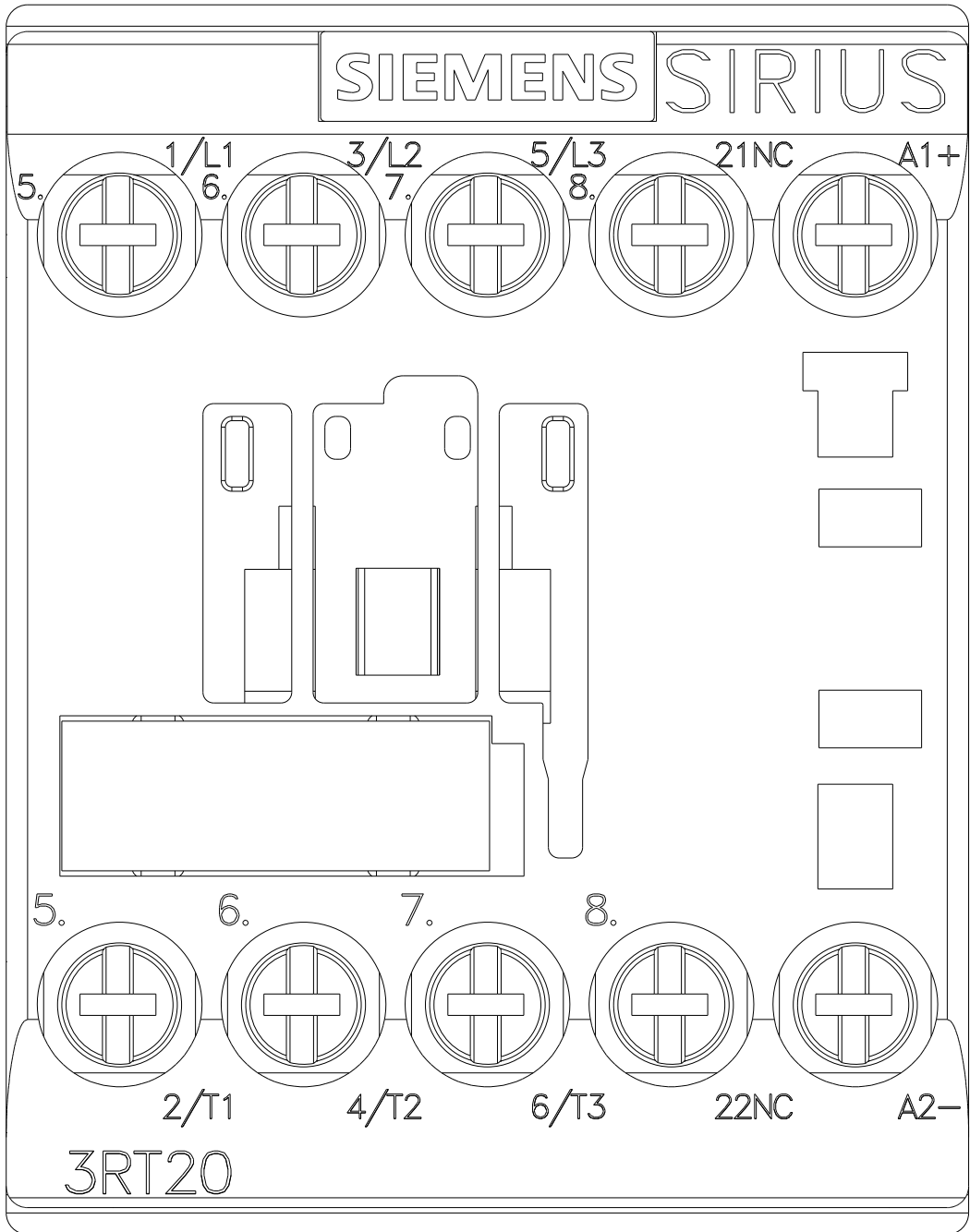

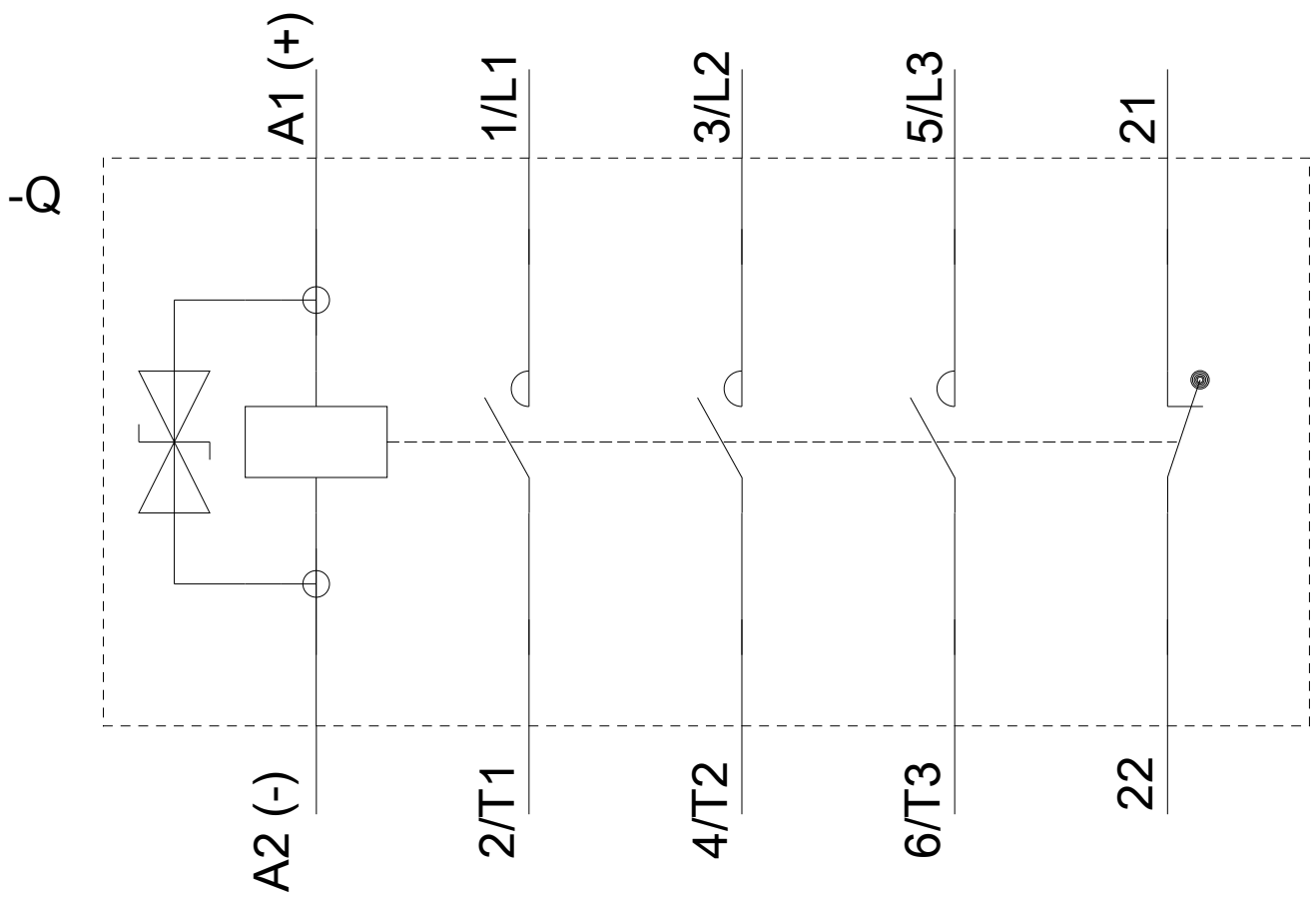

last modified:

11/19/2019