



SIEMENS

Ingenuity for life

Selection & Application Guide

Multi-Family Metering Solutions

Power Mod™ & Uni-PAK

usa.siemens.com/powermod

Power Mod™ and Uni-PAK

Introduction

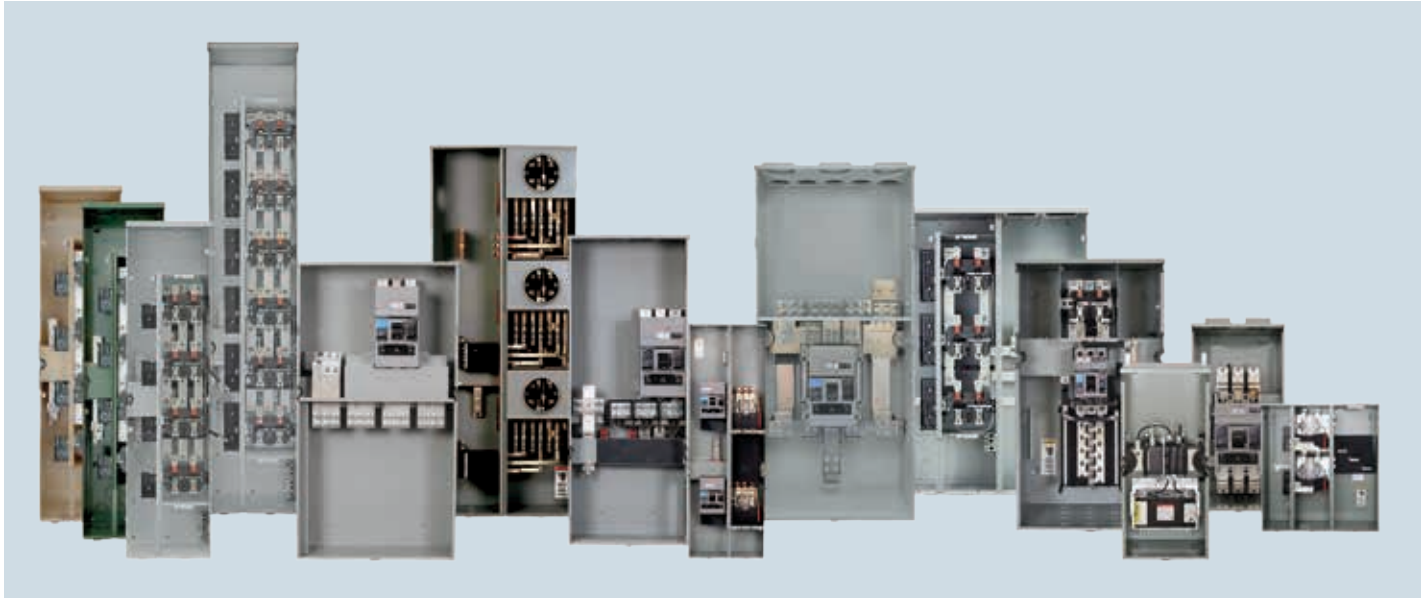

Siemens Power Mod is a robust, flexible, and feature-rich line of modular metering designed to exceed today's market demands. Power Mod's exclusive QuickSystem has been proven to reduce labor by as much as 43% over comparable solutions while exclusive products such as the BFT Main Feed Thru family of mains, allow for lower material cost and incredible flexibility.

Power Mod is built upon service, quality, and flexibility:

Service: every order is made to order and shipped within a competitive lead time. This means all products arrive at the job site on time and together avoiding multiple shipment delays and confusion.

Quality: Power Mod has been tested to all applicable UL and ANSI standards as well as Siemens own rigorous internal specifications. Power Mod only offers 1200amp thru bussing.

All of this is delivered at a competitive lead time and price to other, lower rated products.

Flexibility: for Power Mod flexibility goes well beyond exclusive QuickSystem features. For Siemens this means allowing a variety of solutions to any application that can focus on labor savings, material savings, or both. This also means allowing the ability to configure Power Mod within the COMPAS configuration tool which allows the user to receive a PDF or DXF file of any custom line up.

Power Mod, when combined with Siemens broad line of load centers and exclusive feature arc fault circuit breakers, offers multiple solutions for any application utilizing the industry's broadest portfolio of multi-family metering solutions.



Power Mod™ Basic Installation | Volt Stream Video Series



Power Mod™ Advanced Installation | Volt Stream Video Series

Power Mod™ and Uni-PAK

Table of Contents

QuickSystem Features	2-3
Overview of Power Mod Families	4-10
Introduction and Configuration Tips and Applications	11-19
WB - Standard and Skinny Circuit Breaker Mains	20-24
WEB - Circuit Breaker Pullbox Combinations	25-27
WXB - Cross Bus Mains	28-29
WBT - Feed Thru Tap Box with Breaker	30-31
BFT - Main Feed Thru	32-35
WS - Standard Switch Mains	36-37
WES - Switch Pullbox Combinations	38-39
WXS - Cross Bus Switch Mains	40-41
WTB - Standard Tap boxes	42-43
WET - Tap box Pullbox Combinations	44-45
WT - Feed-Thru Tap boxes	46-47
WMM - Residential Meter Stacks	48-51
WML - Lever Bypass Meter Stacks	52-58
WMLZ - Fusible Residential Lever Bypass Meter Stacks	59-61
WMT - Test Block Bypass Meter Stacks	62-63
WMK - K-Base Meter Stacks	64-65
WC, WCL, WCT - House Power Modules	66-72
WSPD - Surge Protection Units	73-74
WMN ConEd Residential Meter Stacks	75-76
WTBN ConEd Tap boxes	77-78
WMMB - Aux Pull Box	79
Custom Options, Elbows and Spacers	80-81
Uni-PAK Metering Introduction	82-84
Uni-PAK Metering - WP, WEP, WPL	85-89
Multifamily Metering Accessories and Replacement Parts	90-98
Tenant Circuit Breakers	99-100
Uni-PAK Metering Accessories	101
Obsolete Metering Replacement Parts Kits	102
Meter Stack Rating Charts	103-105
Understanding 2017 NEC 240.87 Arc Energy Reduction	106-107
Power Mod Express Stocking Program	108-109
Savings Estimator	110

Power Mod

Introduction to QuickSystem™ Features

Contractor-focused features, robust quality, dependable service, and exclusive products define Siemens Power Mod. The new standard in multi family metering. QuickSystem showcases the key strengths of Power Mod through five labor saving features:



QuickConnect™

A Siemens exclusive feature, QuickConnect reduces bussing connections from many to one – ensuring a single reliable connection instead of multiple connections.

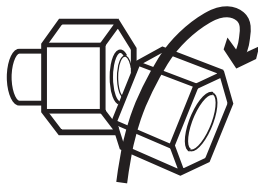

QuickTorque™

QuickTorque eliminates the need for time consuming torque readings. This breakaway nut provides a visual indicator of torque for the QuickConnect. When tightened, the outer head twists off at the proper torque for connection, leaving a single nut for future maintenance.

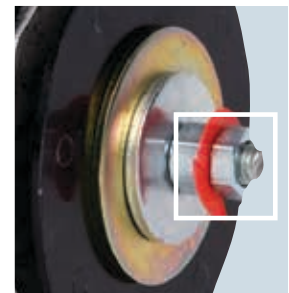

QuickBolt™

A Siemens exclusive feature, QuickBolt eliminates the requirement to line up mechanical connections – instead bolts remain retracted until the openings line up – allowing the bolts to protrude through automatically. Springs push the bolts through and provide positive pressure to keep bolts in place while wingnuts are attached and tightened.

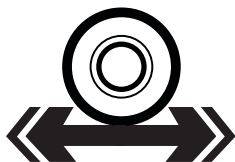

QuickRoll™

A Siemens exclusive feature, QuickRoll eliminates typical metal brackets for mounting modules on the wall. Instead of metal scraping metal, QuickRoll allows the module to glide down the mounting rail via a durable nylon wheel inside a mounting bracket.

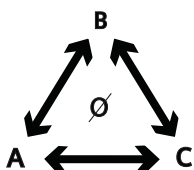

QuickPhase™

Each individual meter position can be phased independently according to the users needs. QuickPhase allows the user the ultimate flexibility to adjust to each individual application. Some exclusions apply.



Power Mod

Introduction to Basic Features

Siemens Modular Metering includes an assortment of module types that can be configured to meet a wide range of residential and commercial group metering applications.

Siemens modular metering provides for single phase, three wire, 120/240V AC; three phase, four wire 120/208Y applications, and three phase in/out, 240 Volt max delta systems. The cross bus that connects devices is aluminum and has a 1200 Amp continuous current rating.

A typical application requires a main device module and one or more residential or commercial meter stacks. Depending on the application additional modules such as a pullbox, tap box, or a spacer may be required.

All of the enclosures are made with G90 galvanized steel and painted with ANSI 61 paint. All swing latches and rivets are made with stainless steel.



QuickConnect™

The time-saving QuickConnect™ (QC) provides a single connection for phase, neutral, and ground – all tightened by a single torque-indicating nut. Factory installed QuickBolt™ spring loaded bolts are located just above and below the QC opening to compress the surrounding gaskets together to form a water-tight seal. For extra stability additional nuts and bolts above and below QuickBolts are included as a means of physically joining the meter stacks together both above and below the QC opening.

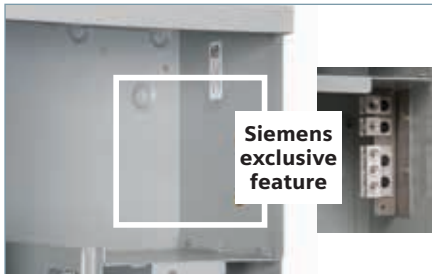

Neutral and Ground Provisions

All grounds and neutrals may be relocated toward the top or bottom of the enclosure depending on where the cables exit.



Tenant Breaker Provisions



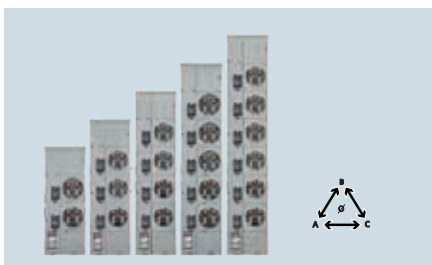



Each 225 Amp meter socket has a provision for a 2-pole 225A max plug-in type QS circuit breaker. The compact QS breaker fits in two inches and reduces enclosure size limited total mounting space required. Single right hand bend wiring saves time and wire. Insert a 125A QP into a 225 Amp QS slot without conversion kits or filler plates. Generous gutter space allows for wires to exit the top, bottom, or back of the meter module.

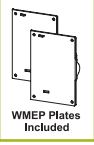

WMM Module factory phasing is as follows:

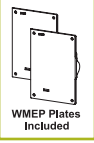

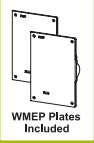

- 2 Gang: AB, BC
- 3 Gang: AB, BC, AC
- 4 Gang: AB, BC, AC, AB
- 5 Gang: AB, BC, AC, AB, BC
- 6 Gang: AB, BC, AC, AB, BC, AC



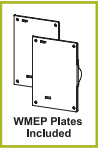
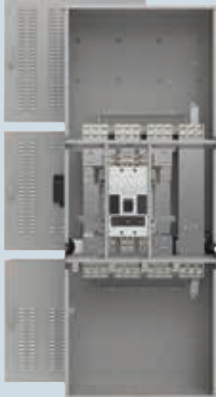
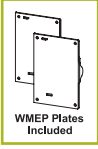

Any position can be adjusted to any phase in the field.

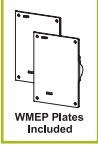

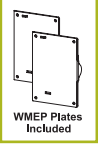

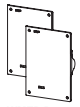
	<p>WB – Standard Circuit Breaker Mains</p> <p>Standard breaker modules (type WB) offer a balance between functionality, feature, and size constraints.</p> <p>Features include:</p> <ul style="list-style-type: none"> ■ Compression lug landing pads (field install up to 1200A, standard feature up to 2000A) ■ Combination overhead and underground feed up to 1200A, dedicated overhead or under ground feed up to 2000A ■ 750kcmil AL wire options ■ 65K AIC standard, 100K AIC available for all models ■ Removable blank bottom endwall ■ Externally accessible breaker handle with padlock capability ■ Broad ampacity ratings up to 2000A with non-standard amperages available (such as 700, 900, etc.) ■ Field installable shunt trips 	<p>Standard Circuit Breaker Mains quick reference</p> <ul style="list-style-type: none"> ■ 200-2000A ■ 1200A thru-bus rating ■ UL Standard # 67 ■ UL file # E27100 ■ AIC rating (65k and 100k) ■ Voltage: <ul style="list-style-type: none"> – Single phase 120/240V AC max – Three phase 240V AC max ■ NEMA 3R rated 
	<p>WEB – Circuit Breaker-Pullbox Combinations</p> <p>EUSERC - compliant breaker - pullbox combination modules (type WEB) offer EUSERC compatibility, a wider range of lug options, and extra space for pulling in conductors.</p> <p>Features include:</p> <ul style="list-style-type: none"> ■ Factory installed NEMA II studs ■ 750 kcmil AL wire options ■ 65K AIC standard, 100K AIC available for all models ■ Removable blank bottom endwall ■ Externally accessible breaker handle with padlock capability ■ Field installable shunt trips ■ Large removable ground wire trough with generous space for grounding conductors 	<p>Circuit Breaker-Pullbox Combo quick reference</p> <ul style="list-style-type: none"> ■ 200-1200A ■ 1200A thru-bus rating ■ UL standard # 67 ■ UL file # E27100 ■ AIC rating (65k and 100k) ■ Voltage <ul style="list-style-type: none"> – Single phase 120/240V AC Max – Three phase 240V AC Max ■ NEMA 3R rated ■ EUSERC drawing number 347 
	<p>WXB – Cross Bus Main</p> <p>The WXB family of main breaker devices features incoming and out-going thru bus connections (no incoming lugs). This patented design allows the user to utilize the WXB family to connect to Siemens Sentron Busway or connect to a tap box (or other main) to lower the overall ampacity of the service disconnect. In addition users can now utilize incoming tap boxes to split the service between multiple mains. This can save the end-user on the material cost of the meter bank. Please see the applications pages for more information.</p> <p>Features include:</p> <ul style="list-style-type: none"> ■ Incoming and Outgoing Power Mod thru bus ■ 65K AIC standard, 100K AIC available for all models ■ Broad ampacity ratings up to 1200A with non-standard amperages available (such as 700, 900, etc...) ■ Field installable shunt trip 	<p>Cross Bus Mains quick reference</p> <ul style="list-style-type: none"> ■ 400-1200A ■ 1200A thru-bus rating ■ UL Standard #67 ■ UL file # E27100 ■ AIC rating (65k and 100k) ■ Voltage: <ul style="list-style-type: none"> – Single phase 120/240V AC max – Three Phase 240V AC max ■ NEMA 3R (outdoor)  

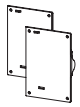

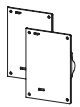

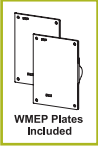

Power Mod





Overview of Families







	<p>WBT - Feed Thru Tap Box with Horizontal Bus Breaker</p> <p>Feed thru tap box and breaker module (type WBT) offers the ability to pull conductors in and out of the enclosure for rise cable or loop feed applications as well as a main breaker device utilizing an incoming and out-going thru bus connections (including incoming lugs). This patented design allows the user to utilize the WBT family to connect to Siemens Sentron Busway.</p> <p>Features include:</p> <ul style="list-style-type: none"> ■ Incoming and Outgoing Power Mod thru bus ■ Standard compression lug capability ■ 65K AIC standard, 100K AIC available for all models ■ Broad ampacity ratings up to 1200 Amps 	<p>Feed Thru Tap Box with Breaker quick reference</p> <ul style="list-style-type: none"> ■ 200-1200A (breaker) ■ 400-2400A (feed thru) ■ 1200 thru-bus rating ■ UL Standard #67 ■ UL file #E27100 ■ AIC rating (65K and 100K) ■ Voltage: <ul style="list-style-type: none"> – Three Phase 240V AC max ■ NEMA 3R rated 
	<p>BFT - Main Feed Thru</p> <p>Main feed thru (type BFT) breaker modules has the ability to isolate power to side-mounted modules just like any other Power Mod main breaker module, but also contains feed-through lugs that can be used to supply and isolate power vertically to downstream group metering line ups.</p> <p>Features include:</p> <ul style="list-style-type: none"> ■ Incoming and Outgoing Power Mod thru bus ■ Standard compression lug capability ■ 65K AIC standard, 100K AIC available for all models ■ Main breaker with broad ampacity ratings from 1200A to 2000A 	<p>Main Feed Thru quick reference</p> <ul style="list-style-type: none"> ■ 1200 - 2000A main bus rating ■ 1200A Horizontal bus rating ■ UL Standard #67, file #E27100 ■ AIC rating (65K & 100K) ■ Voltage: 240V AC max ■ Available in single and three phase ■ NEMA 1 (Indoor) ■ Bottom feed only ■ All units come with no hubs ■ EUSERC drawing number 347 (EUSERC applies to 1200A unit only) 
	<p>WS - Standard Switch Mains</p> <p>Standard switch modules (type WS) are designed for flexibility, space savings, and durability.</p> <p>Features include:</p> <ul style="list-style-type: none"> ■ Standard compression lug capability ■ Invertibility: 400-800 Amp devices can be rotated to accommodate the desired incoming feed direction ■ 750 kcmil AL wire options for most models ■ 100K AIC standard for all models ■ Class T fuse provisions ■ Broad ampacity ratings up to 1200 Amps 	<p>Standard Switch Mains quick reference</p> <ul style="list-style-type: none"> ■ 400-1200A ■ 1200A thru-bus rating ■ UL Standard # 98 ■ UL file #E25506 ■ AIC rating (100k AIC) ■ Voltage: <ul style="list-style-type: none"> – Single phase 120/240V AC max – Three phase 240V AC max ■ NEMA 3R rated 
	<p>WES - Switch-Pullbox Combinations</p> <p>EUSERC - compliant switch-pullbox combination modules (type WES) offer EUSERC compatibility, a wider range of lug options, and extra space for pulling in conductors.</p> <p>Features include:</p> <ul style="list-style-type: none"> ■ Factory installed NEMA II studs ■ Broad ampacity ratings up to 1200 Amps ■ 750kcmil AL wire options ■ 100K AIC standard for all models ■ Removable blank bottom endwall ■ Class T fuse provisions ■ Extra ground lugs in each device 	<p>Switch-Pullbox Combo quick reference</p> <ul style="list-style-type: none"> ■ 400-1200A ■ 1200A thru-bus rating ■ UL standard # 98 ■ UL file # E25506 ■ AIC Rating (100k AIC) ■ Voltage: <ul style="list-style-type: none"> – Single phase 120/240V AC max – Three phase 240V AC max ■ NEMA 3R rated ■ EUSERC drawing numbers 315, 343, and 347 

	<p>WXS - Cross Bus Switch</p> <p>The WXS family of switches offers a standardized means of connecting Siemens Sentron busway to Power Mod for mid and high-rise applications. The Sentron Busway is connected via the TapStack which converts Sentron busway connections over to Power Mod thru bus connections. This enables the user to connect to Power Mod in as little as 9" of wall space.</p> <p>Features include:</p> <ul style="list-style-type: none"> ■ Fast connection of end-feed busway to Power Mod meter banks ■ Class T fuse provisions ■ 100K AIC standard for all models 	<p>Pull Box quick reference</p> <ul style="list-style-type: none"> ■ 400,600,800A ■ 1200 Amp thru-bus rating ■ UL Standard #98 ■ UL file # E25506 ■ AIC rating: 100K ■ Voltage <ul style="list-style-type: none"> - Single phase 120/240V AC max - Three Phase 240V AC max ■ NEMA 3R rated <div data-bbox="1377 281 1474 426">  <p>WMEP Plates Included</p> </div> <div data-bbox="1377 447 1474 592">  <p>QuickConnect™ Included</p> </div>
	<p>WTB - Standard Tap boxes</p> <p>Standard tap box modules (type WTB) are designed for versatility, space savings, and flexibility.</p> <p>Features include:</p> <ul style="list-style-type: none"> ■ Standard compression lug capability ■ Invertibility: devices can be rotated to accommodate the desired incoming feed direction ■ 750 kcmil AL wire options for most models ■ 100K AIC standard for all models ■ Broad ampacity ratings from 400 to 2400 Amps ■ Line and load capability- service entrance and sub-feed rated 	<p>Standard Tap box quick reference</p> <ul style="list-style-type: none"> ■ 400-2400A ■ 1200A thru-bus rating ■ UL Standard # 67 ■ UL file # E27100 ■ AIC rating (100K AIC) ■ Voltage <ul style="list-style-type: none"> - Single phase 120/240V AC max - Three phase 240V AC max ■ All swing latches and rivets are stainless steel. ■ NEMA 3R rated <div data-bbox="1377 806 1474 951">  <p>WMEP Plates Included</p> </div>
<p>⚠ Restrictions for 1600-2400A type WTB Power Mod Tap Boxes: ⚠</p> <p>When the 1600, 2000, or 2400A tap boxes are used as service entrance equipment (fed directly from utility transformer) or when the supply originates from a Class L fuse or Siemens WL circuit breaker there are restrictions on the use of an additional down-stream (thru-bus connected) WTBN, WTB, WET, or WT type Power Mod tap boxes. In these instances a type "WXB" module must be used as protection for the down- stream tap box. box (placed between the incoming WTB tap box and the downstream outgoing tap box). This restriction does NOT apply if the tap box is fed from a Siemens Sentron or VL series molded case circuit breaker. Note that the maximum amperage for a Siemens Sentron circuit breaker is 2,000A.</p>		
	<p>WET - Tap box - Pullbox Combinations</p> <p>EUSERC - compliant Tap box-Pullbox Combination modules (type WET) offer EUSERC compatibility, a wider range of lug options, and extra space for pulling in conductors.</p> <p>Features include:</p> <ul style="list-style-type: none"> ■ Standard compression lug capability ■ 750 kcmil AL wire options for most models ■ 100K AIC standard for all models ■ Broad ampacity ratings from 400 to 1200 Amps ■ Removable bottom endwall 	<p>Tap box- Pullbox Combination quick reference</p> <ul style="list-style-type: none"> ■ 400-1200A ■ 1200 Amp thru-bus rating ■ UL Standard #'s 67 ■ UL file # E27100 ■ AIC Rating (100k) ■ Voltage <ul style="list-style-type: none"> - Single phase 120/240V AC max - Three phase 240V AC max ■ All swing latches and rivets are stainless steel. ■ NEMA 3R rated ■ EUSERC drawing numbers 343, 343A, 347 (Pullbox) <div data-bbox="1377 1501 1474 1646">  <p>WMEP Plates Included</p> </div>

	<p>Feed-thru tap boxes (type WT) offer the ability to pull conductors in and out of the enclosure for riser cable or loop feed applications.</p> <p>Features include:</p> <ul style="list-style-type: none"> ■ Standard compression lug capability ■ 750kcmil Al wire options ■ 100k AIC standard ■ Removable bottom endwall ■ Broad ampacity ratings from 400 to 2400 Amps 	<ul style="list-style-type: none"> ■ 400-2400A ■ 1200A thru bus ■ UL Standard #67 ■ UL file no. E27100 ■ AIC rating (100k AIC) ■ Voltage <ul style="list-style-type: none"> - Single phase 120/240V AC max - Three phase 240V AC max ■ NEMA 3R rated 
<p>⚠ Restrictions for 1600-2400A type WT Power Mod Pull-Thru Tap Boxes: ⚠</p> <p>When the 1600, 2000, or 2400A tap boxes are used as service entrance equipment (fed directly from utility transformer) or when the supply originates from a Class L fuse there are restrictions on the use of an additional down-stream (thru-bus connected) WTBN, WTB, WET, or WT type Power Mod tap boxes. In these instances a type "WXB" module must be used as protection for the downstream tap box (placed between the incoming WT tap box and the downstream outgoing tap box). This restriction does NOT apply if the tap box is fed from a Siemens Sentron or VL series molded case circuit breaker. Note that the maximum amperage for a Siemens Sentron circuit breaker is 2,000A. Please note that Siemens type WL circuit breakers can NOT be used to feed WT Power Mod tap boxes.</p>		
	<p>WMM – Residential Meter Stacks</p> <p>The residential meter stacks (type WMM) are designed for residential applications. This core product offers many variations to meet the customers' requirements.</p> <p>Features include:</p> <ul style="list-style-type: none"> ■ Movable neutrals and grounds. ■ Pivoting rain gutter. ■ Removable back plate. ■ Center punch dimples (outdoor). ■ QP breakers used in 125A. ■ 225A versions can use QS or QP breakers. 	<p>Residential Meter Stacks quick reference</p> <ul style="list-style-type: none"> ■ 2-6 gang ■ 125/225A per position ■ 1200 Amp thru-bus rating ■ UL Standard #67 and #414 ■ UL file no. E27100 ■ AIC rating (65k and 100k) ■ Voltage: <ul style="list-style-type: none"> - Single phase 120/240V AC max. - Three phase in single phase out <ul style="list-style-type: none"> ● 120/208V AC max. ● 240/120V AC max. ■ Outdoor= NEMA 3R rated ■ Indoor= NEMA 1 rated 
	<p>WML – Lever Bypass Meter Stacks</p> <p>Commercial Lever Bypass meter stacks (type WML) are designed to meet the requirements of those utilities specifying lever bypass meter sockets for residential and commercial applications.</p> <p>Features include:</p> <ul style="list-style-type: none"> ■ High-quality, time-proven Talon HQ sockets ■ A line of 3-phase 100 Amp meter stacks to minimize tenant main cost ■ Removable back knockout plate to facilitate wiring ■ 225 Amp capability in single and three phase designs ■ Up to 4 positions with 225 Amp tenant mains, up to 2 positions with 400 Amp tenant mains ■ Ease of wiring – tenant mains require only a single bend 	<p>Lever Bypass quick reference</p> <ul style="list-style-type: none"> ■ 100A/225A 1-4 position ■ 400A 1-2 position ■ 1200A thru-bus rating ■ UL Standard # UL67 ■ UL file # E27100 ■ AIC rating (25K, 65K and 100K) ■ Voltage <ul style="list-style-type: none"> - Single phase 120/240V AC max - Three in single phase out 208Y/120V AC - Three Phase 240V AC max ■ All swing latches and rivets are stainless steel. ■ Outdoor = NEMA 3R rated ■ Indoor = NEMA 1 rated 

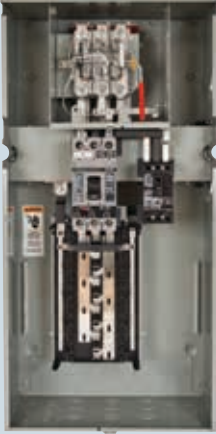
	<p>WML - Fusible Switch Lever Bypass Meter stacks</p> <p>This Commercial Lever Bypass meter stacks (type WML) feature a 400 Amp - class T - fusible pull out assembly. Features include:</p> <ul style="list-style-type: none"> ■ High-quality, time proven Talon HQ sockets ■ Removable back knockout plate to facilitate wiring ■ Available in single and three phases designs ■ Single position with 400 Amp tenant main ■ Ease of wiring 	<p>Lever Bypass With Fusible Switch Quick Reference:</p> <ul style="list-style-type: none"> ■ 400A 1 position ■ 1200A thru bus rating ■ UL Standard #UL67 ■ UL file #E27100 ■ AIC rating 65KAIC ■ Voltage: <ul style="list-style-type: none"> – Single phase 120/240V AC max – Three phase in, single phase out 208Y/120V AC – Three Phase 240V AC max ■ Outdoor= NEMA 3R rated ■ Indoor= NEMA 1 rated 
	<p>WMLZ/ WMLZF – Fusible Residential Lever Bypass Meter Stacks</p> <p>The WMLZ and WMLZF lever bypass meter stacks are designed to allow the use of class T (400 Amp max) fuses ahead of all meter positions where the local serving utility may require it. WMLZF stacks feature a 400 Amp fusible pull out assembly which connects to a secondary 400 Amp thru bus that can feed downstream meter stacks. The WMLZ stacks include the secondary thru bus that can connect from the WMLZF meter stacks. The standard Power Mod 1200amp thru bus "passes thru" to feed downstream modules – the meter sockets in WMLZ and WMLZF do NOT connect directly to the 1200 Amp thru bus – only to the 400 Amp thru bus.</p> <p>Features include:</p> <ul style="list-style-type: none"> ■ High-quality, time proven Talon HQ sockets ■ 125 Amp capability for 3-phase in/ single-phase out ■ 3 to 6 positions in both the fused stack and the expansion stack ■ 400 Amp class T fusible-pullout in WMLZF stacks ■ Secondary 400 Amp thru bus to supply power to downstream sockets ■ Ease of wiring – tenant mains require only a single bend ■ Preconfigures and wired. 	<p>Xcel Residential Lever Bypass Quick Reference:</p> <ul style="list-style-type: none"> ■ 125A 3-6 position ■ 1200A thru bus rating ■ 400A secondary thru-bus rating and vertical bus rating ■ UL Standard #UL67 ■ UL file #E27100 ■ AIC rating (100K) ■ Voltage <ul style="list-style-type: none"> – Three phase in, single phase out 208Y/120V AC ■ Outdoor = NEMA 3R rated ■ Indoor = NEMA 1 rated 
	<p>WMT – Test Block Bypass Meter Stacks</p> <p>Commercial Test Block Bypass Meter Stacks (type WMT) are designed to meet the requirements of those utilities specifying test block bypass meter sockets for commercial applications in areas subscribing to the EUSERC standards.</p> <p>Features include:</p> <ul style="list-style-type: none"> ■ High-quality, time-proven Siemens SMM switchboard meter socket ■ Removable back knockout plate to facilitate wiring ■ 225 Amp capability in single and three phase designs ■ Up to 3 positions with 225 Amp tenant mains ■ Wiring flexibility - tenant mains require only a single bend ■ Three phase input, single phase output modules ■ In line wiring: side knockouts allow wiring for adjacent units to pass through 	<p>Test Block Bypass quick reference</p> <ul style="list-style-type: none"> ■ 225A 1-3 positions ■ 1200A thru-bus rating ■ UL Standard #'s 67 ■ UL file # E27100 ■ AIC Rating (100k) ■ Voltage <ul style="list-style-type: none"> – Single phase 120/240V AC max – 3 phase in single phase out 120Y/208V AC max – Three phase 240V AC max ■ Outdoor= NEMA 3R rated ■ Indoor= NEMA 1 rated ■ EUSERC drawing numbers 312 and 353 

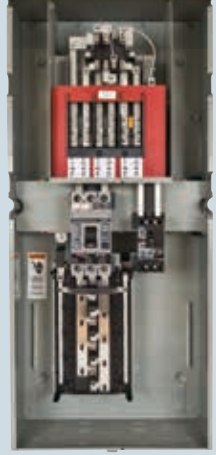
	<p>WSPD – Integral surge protection device for multi-family applications</p> <p>Surge protection modules for Power Mod (type WSPD) are thru-bus connected modules that allow the user to view surge status as well as access the SPD control panel without breaking the utility seal on the enclosure. An optional breaker disconnect is available to enable the end user to replace the SPD (surge protection device) without having to disconnect utility power to the Power Mod installation.</p> <p>Features include:</p> <ul style="list-style-type: none"> ■ 100,200,300,400,500kA ratings available ■ External, vandal resistant and lockable clear cover over SPD control panel ■ Single phase thru bus and three phase thru bus ■ Optional breaker disconnect that opens phase and neutral to make SPD replacement quick and easy 	<p>Surge Module quick reference</p> <ul style="list-style-type: none"> ■ 100-500kA ratings available ■ 1200A thru-bus rating ■ UL Standard #67 ■ UL file # E27100 ■ AIC rating: 100K ■ Voltage <ul style="list-style-type: none"> – Single phase 120/240V AC max – Three Phase 240V AC max ■ NEMA 3R rated 
	<p>WMK – K-Base Meter Stacks</p> <p>Commercial K-Base Meter Stacks (type WMK) are designed to meet the requirements of those utilities specifying bolt-in meter sockets for 400 and 600 Amp residential and commercial applications.</p> <p>Features include:</p> <ul style="list-style-type: none"> ■ Exclusive Talon K4, K5, and K7 meter sockets ■ 1 position K4, K5, K7 modules with 400 and 600 Amp tenant mains ■ 2 position K7 module with 400 Amp tenant main ■ Space saving design 	<p>K-Base quick reference</p> <ul style="list-style-type: none"> ■ 400A and 600A 1-2 positions ■ 1200A Thru bus-rating ■ UL Standard # 67 ■ UL file # E27100 ■ AIC Rating (25k) ■ Voltage <ul style="list-style-type: none"> – Single Phase 120/240V AC Max – Three In Single Phase Out 208Y/120V AC – Three Phase 240V AC Max ■ NEMA 3R rated 
	<p>WMMB – auxillary pull boxes for use with WB, WTB, and WS Power Mod modules</p> <p>Auxillary pull boxes are used in cases where WEB, WES, or WET modules were not or cannot be used, but the user still needs to comply with the EUSERC standard. These modules feature incoming NEMA II stud pattern lugs for underground feed and allow the user to pull wire from the lug landing in the pull box thru a 6" knockout and into: 400-1200A WB, WTB and 400-800A WS modules. Note this family does NOT have any thru bus.</p> <p>Features include:</p> <ul style="list-style-type: none"> ■ 6" side opening (right or left) with available gasket to help mitigate wire insulation damage ■ EUSERC compliant incoming pull section 	<p>Pull Box quick reference</p> <ul style="list-style-type: none"> ■ 400A, 800A,1200A ■ UL Standard #67 ■ UL file # E27100 ■ AIC rating: 100K ■ Voltage <ul style="list-style-type: none"> – Single phse 120/240V AC max – Three Phase 240V AC max ■ NEMA 3R rated

	<p>WC – Residential meter socket with load center distribution panel</p> <p>The meter-load center combination offered by the WC series is unique and exclusive to the Siemens Power Mod family. This product offers the ability to combine house power applications with a meter socket thereby reducing material (pipe and wire) and installation time (separate load center or panel board).</p> <p>Features include:</p> <ul style="list-style-type: none"> ■ Single phase thru bus and three phase thru bus ■ 20 space - 40 circuit interior for single phase out put devices ■ 24 space - 42 circuit interior for three phase out put devices ■ Copper bus PL Series Siemens load center interior ■ Dual neutral and ground provisions with Siemens patented Instawire technology ■ Optional subfeed breaker for elevator applications ■ 250 Amp overall device rating 	<p>WC House Power Panel quick reference:</p> <ul style="list-style-type: none"> ■ 250A, 1 position ■ 1200 Amp thru-bus rating ■ UL Standard #67 ■ UL Standard #414 ■ UL file # E27100 ■ AIC rating: 100K ■ Voltage <ul style="list-style-type: none"> – Single phase 120/240V AC max – Three in single phase out 208Y120V AC – Three Phase 240V AC max ■ NEMA 3R rated ■ Copper load center bus bars ■ 125A MAX subfeed breaker- factory installed (type HED4) ■ 225A MAX main breaker- factory installed (type HFD6) 
	<p>WCL – Commercial Lever Bypass meter socket with load center distribution panel</p> <p>The meter-load center combination offered by the WCL series is unique and exclusive to the Siemens Power Mod family. This product offers the ability to combine house power applications with a meter socket thereby reducing material (pipe and wire) and installation time (separate load center or panel board). WCL modules feature the Talon HQ lever bypass for those utilities that specify lever bypass for residential and commercial applications.</p> <p>Features include:</p> <ul style="list-style-type: none"> ■ Single phase thru bus and three phase thru bus ■ 20 space - 40 circuit interior for single phase out put devices ■ 24 space - 42 circuit interior for three phase out put devices ■ Copper bus PL Series Siemens load center interior ■ Dual neutral and ground provisions with Siemens patented Instawire technology ■ Optional subfeed breaker for elevator applications ■ 250 Amp overall device rating 	<p>WCL House Power Panel quick reference:</p> <ul style="list-style-type: none"> ■ 250A, 1 position ■ 1200A thru-bus rating ■ UL Standard #67 ■ UL Standard #414 ■ UL file # E27100 ■ AIC rating: 100K ■ Voltage <ul style="list-style-type: none"> – Single phase 120/240V AC max – Three in single phase out 208Y120V AC – Three Phase 240V AC max ■ NEMA 3R rated ■ Copper load center bus bars ■ 125A MAX subfeed breaker- factory installed (type HED4) ■ 225A MAX main breaker- factory installed (type HFD6) 
	<p>WCT – Commercial Test Block Bypass meter socket with load center distribution panel</p> <p>The meter-load center combination offered by the WCT series is unique and exclusive to the Siemens Power Mod family. This product offers the ability to combine house power applications with a meter socket thereby reducing material (pipe and wire) and installation time (separate load center or panel board). WCT modules feature a test block bypass socket for utilities subscribing to the EUSERC standard.</p> <p>Features include:</p> <ul style="list-style-type: none"> ■ Single phase thru bus and three phase thru bus ■ 20 space - 40 circuit interior for single phase out put devices ■ 24 space - 42 circuit interior for three phase out put devices ■ Copper bus PL Series Siemens load center interior ■ Dual neutral and ground provisions with Siemens patented Instawire technology ■ Optional subfeed breaker for elevator applications ■ 250amp overall device rating 	<p>WCT House Power Panel quick reference:</p> <ul style="list-style-type: none"> ■ 250A, 1 position ■ 1200A thru-bus rating ■ UL Standard #67 ■ UL Standard #414 ■ UL file # E27100 ■ AIC rating: 100K ■ Voltage <ul style="list-style-type: none"> – Single phase 120/240V AC max – Three in single phase out 208Y120V AC – Three Phase 240V AC max ■ NEMA 3R rated ■ Copper load center bus bars ■ 125A MAX subfeed breaker- factory installed (type HED4) ■ 225A MAX main breaker- factory installed (type HFD6) 

Power Mod

Introduction

The breadth of the Power Mod product line is unmatched in the industry today. The available options result in many different ways to configure the same project with some solutions focusing on material cost and other solutions that create the opportunity for labor savings. The following pages contain examples and tips for using Power Mod in common multi-family metering applications including, but not limited to high rise buildings, mixed use, and garden style apartment complexes.

The following items are configuration tips and rules to keep in mind:

Ampacity and Bussing

Configurations are limited by the continuous current ratings for the main device (service entrance) and the thru bus. The Power Mod thru bus is always rated for 1200A from the factory. Siemens does not offer low 800A rated thru bus. All thru bus within the same meter bank must be single phase or three phase. Single and three phase thru bus cannot be mixed within the same meter bank.

Connections

A QuickConnect is required for each thru bus connection and is supplied with all WMM, WML, WMT, WC, WCL, WCT, WSPD, WMK, WXB, WXS, BE, WSP and WELB modules. The QuickConnect houses all phase, neutral, ground/bonding connections between Power Mod modules.

Utility Requirements

Utilities have varying requirements for equipment height, cover types, and bypass types. Therefore, utility acceptance should be verified prior to installation of any equipment. The COMPAS configuration tool can be utilized by any authorized Siemens sales or distributor representative to show critical dimensions of any installation.

Service Entrance Modules and Requirements

- In group metering applications, breaker mains larger than 1200A have been used for years as center-fed devices where the load out of either side is 1200A or lower. This practice is acceptable because the products are tested as a complete system in accordance with UL standards. When installed per these instructions, the Panelboard will meet the UL listing of the product and will be consistent with proven industry standard practice.
- EUSERC-compliant service entrance modules (families WEB, WES, WET) are underground feed only and offer a wider range of lug options due to the larger enclosure size. These devices are also setup for compression lug installations from the factory.
- Tap boxes (families WTB, WT, WET) provide a direct connection to the thru bus and do not provide any overcurrent protection. These families should never be used to feed other main devices that have incoming lugs (families WB, WEB, WS, WES). A tap box CAN be used with the WXB

and WXS cross bus main families. All tap box families can be used as a service entrance point or a load side feed for remote equipment. An additional QuickConnect must be ordered separately when using a tap box on the load side. The WTB family features invertibility on 400 –1600A models. Each item from this family includes two sets of QuickBolts. The eventual left side must be removed prior to installation.

- WB service entrance breaker modules: 200 thru 1200A modules are combination feed allowing service entrance conductors to enter the top or bottom of the enclosure. 1400-1600amp WB modules come in top or bottom feed (combination feed is not available). 2000A WB modules are available in dedicated bottom feed or combination feed configurations.
- WS service entrance switch modules: 400 to 800A modules are invertible for top or bottom feed. Each includes two sets of QuickBolts. The eventual left side must be removed prior to installation. 1200A WS modules are bottom feed only and utilize a molded case switch (looks like a breaker) for the switching mechanism.

Spacing Requirements

A spacer is commonly required between a meter stack and a service entrance module. This is usually due to the need to have a minimum distance (left or right) from the meter to any obstruction. TIP: when the service entrance main is on the LEFT and you need a 125A tenant main WMM stack use a 225A WMM meter stack instead. The extra width of the 225A stack will provide 10" of clearance from the main and, since you can use a standard Q2100 or Q2125 in the stack, the cost increase from 125A to 225A is still less than adding a spacer (type WSP). This also saves the installation labor of the spacer.

Breaker Provisions

A tenant breaker must be ordered separately for each tenant position or configured as factory installed within the COMPAS configuration tool. Blank filler plates are not available thus un-used positions must have a breaker installed or the access cover must be locked.

Space Savings

Utilize the WC-WCL-WCT families to save space. These devices allow for consolidating the typical setup of a meter stack and separate panel into a single device if the application. This allows for less wall space, increased material savings, and a lower install cost. Please see the configurations on the following pages for examples.

Material Savings

Utilize the WXB cross bus mains to lower your overall material cost. When a large ampacity main is needed (1200A or above) utilizing a tap box and a WXB main can lower the overall cost by eliminating costly large frame breakers from the installation. As shown in figures 3 and 4 the installation does require more wall space, but the overall dollars are lower.

Power Mod

Applications: Typical Configurations

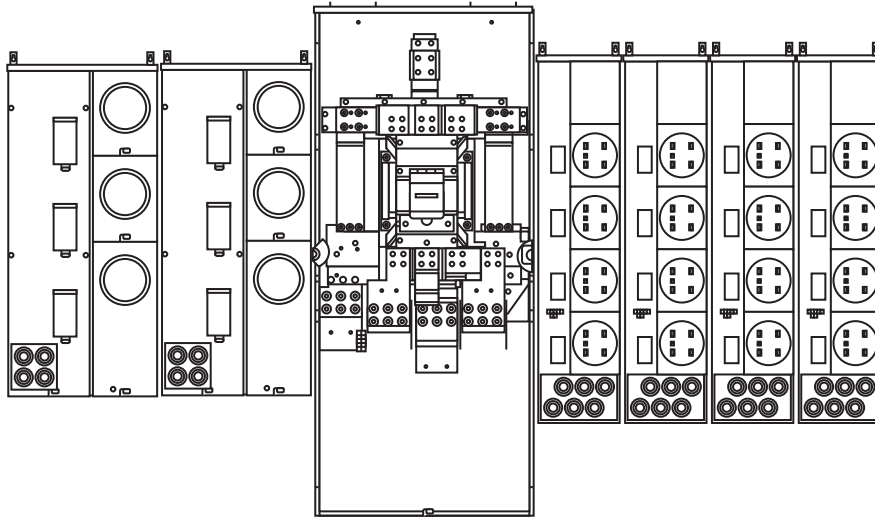

Figure 1

Incoming Service: 1600 Amps

Details: This installation requires a center fed main because the incoming service is over the thru bus rating of 1200 Amps.

Takeaway: Any main or tapbox over 1200A must be center-fed so not to overload the bus.

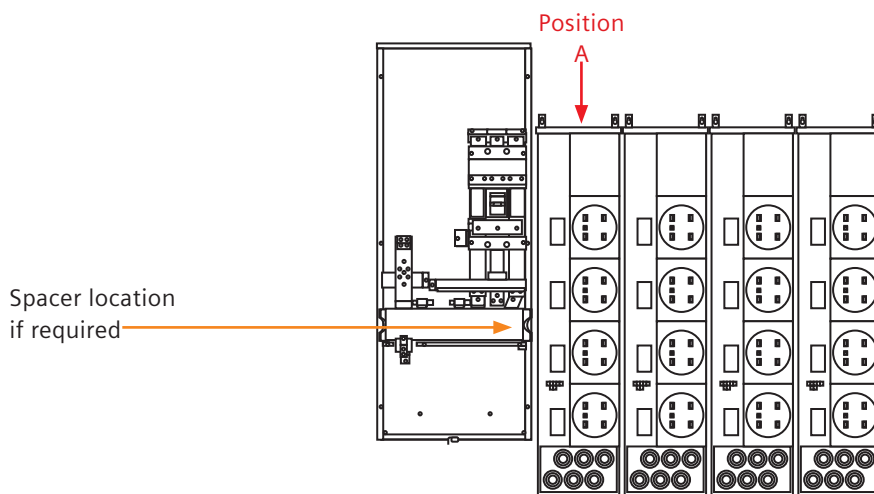

Figure 2

Incoming Service: 1200 Amps

Details: This installation is shown as end feed from the left, but could be right or center fed as well since the main service does not exceed 1200 Amps. Some areas of the US have maintenance space requirements regarding meter sockets. In these areas a spacer (family WSP) could be placed between the WB module and the WMM stack labeled "Position A" to give a technician space to work on the watt hour meter. Another option would be to utilize a 225 Amp WMM stack in position A thereby eliminating the need for the spacer and lowering the overall cost.

Power Mod

Applications: WXB Family of Cross Bus Mains

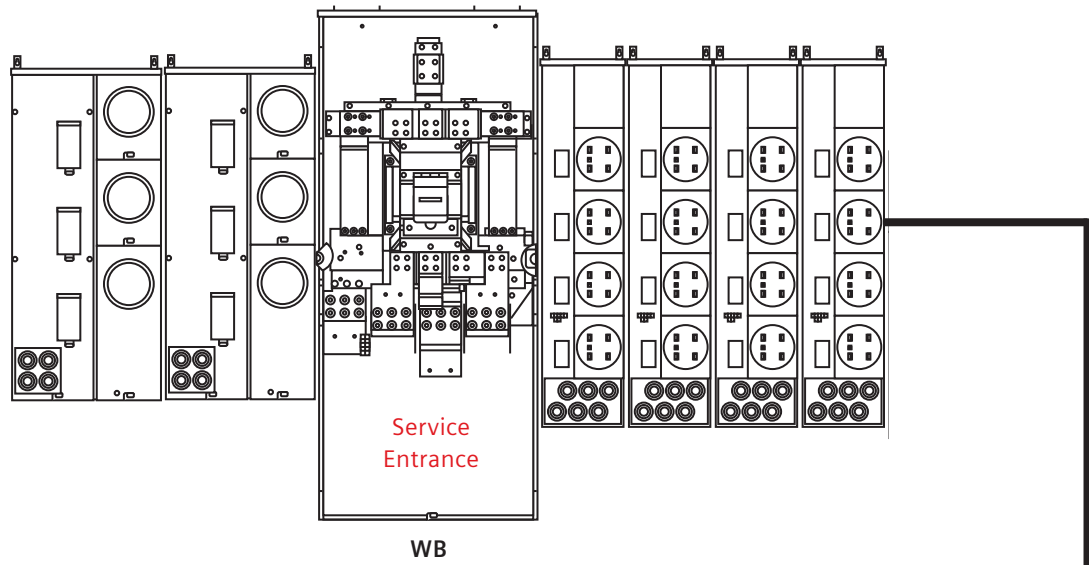

Figure 3

Incoming Service: 1600 Amps

Details: The installation above has a 1600 Amp 3 phase WB main (WB31600B) which is feeding WML321225RJ stacks to the left and WMM42125RJ stacks to the right. Overall it has a width of 130.7" and has a list price of \$15,366.①

Functionally, these two lineups are accomplishing the same task using different modules

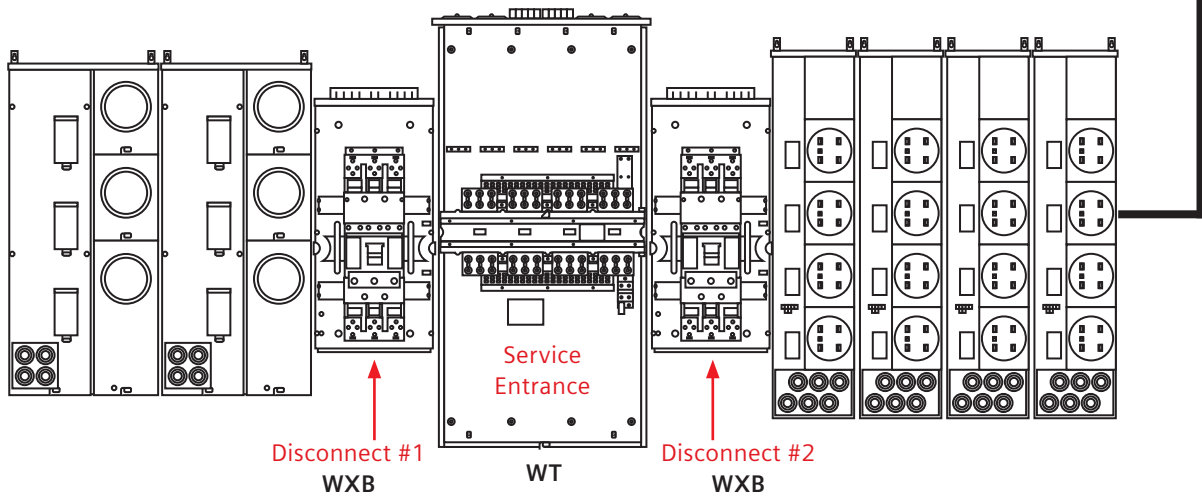

Figure 4

Incoming Service: 1600 Amps

Details: This installation can meet the same application as Figure 3 above, but replaces the 1600 Amp WB main with a tap box (WT31600PU in this case). The service disconnects are labeled #1 and #2 above. By dividing the incoming current into 2 mains- even though more modules were added- the overall list price DROPS to \$13,982. Width grows by 31", BUT there is now a 9% savings on material! ①

① Pricing subject to change without notice.

Power Mod

Applications: WXB Family of Cross Bus Mains

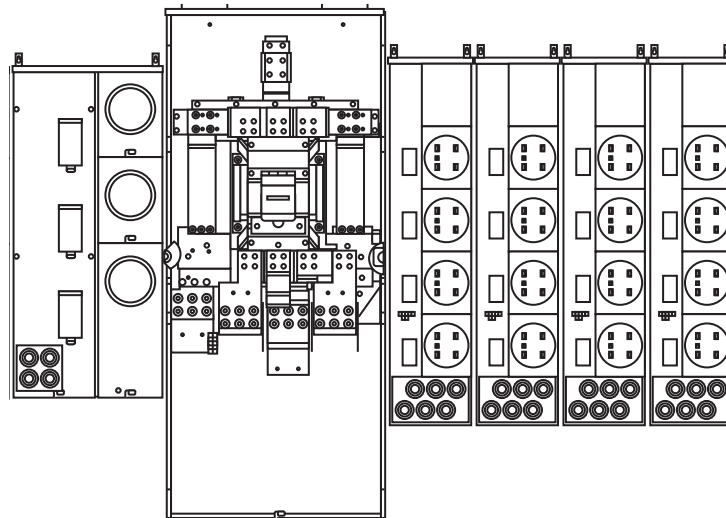

Figure 5

Incoming Service: 1600 Amps

Details: The installation above has a 1600 Amp 3 phase WB main (WB31600B) which is feeding a WML321225RJ stack to the left and WMM42125RJ stacks to the right.

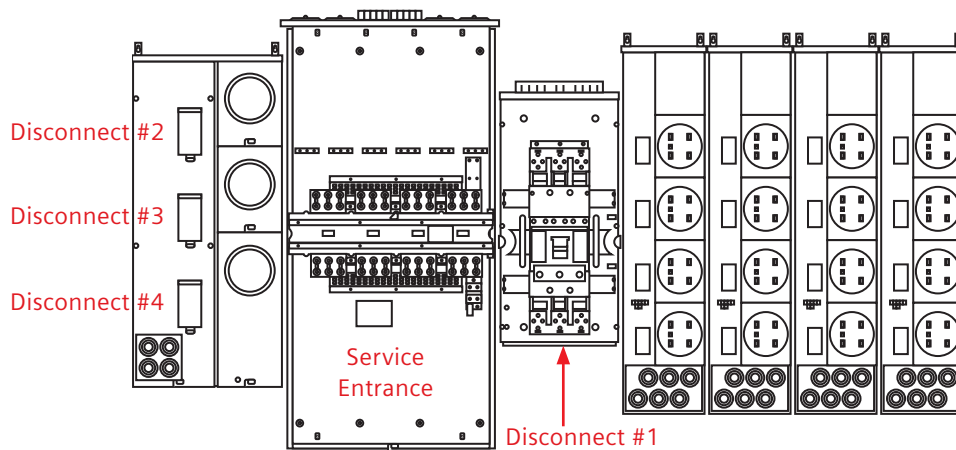

Figure 6

Incoming Service: 1600 Amps

Details: This installation can meet the same application as Figure 5 above, but replaces the 1600amp WB main with a tap box (WT31600PU in this case). The right side utilizes the new WXB31200N cross bus main. The left side works off of the six disconnect rule. In removing the 1600 Amp WB and adding the WXB the width grew by 8", but the list price drops by over 20% offering a tremendous savings on material. Another option would be to utilize a WB main breaker to feed a remotely mounted CT cabinet. The overall application remains the same- taking the large 1600amp incoming service and splitting it between 2 main disconnects.

Power Mod

Applications: WC-WCT-WCL House Power Modules

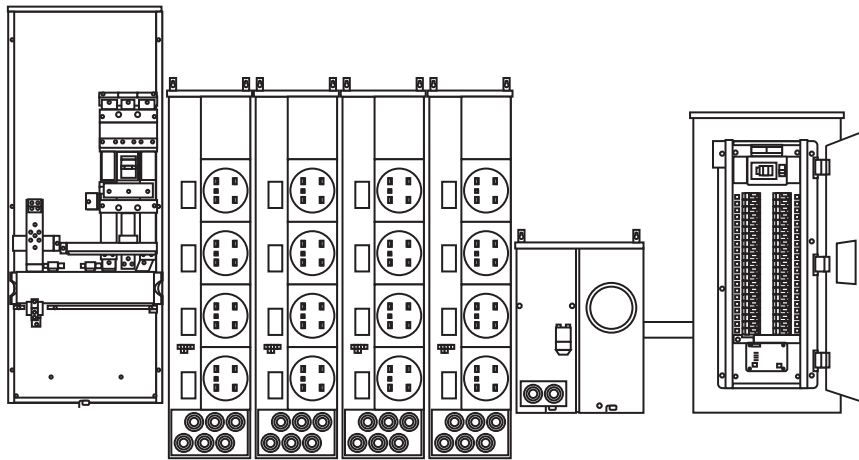

Figure 9

Incoming Service: 1200 Amps

Details: The installation above has a 1200 Amp 3 phase WB main (WB31200C) feeding WMM residential stacks and a WML13225RJ (1) position commercial meter stack. The WML is feeding a P1 lighting panel approximately 2' away. The P1 is the house power panel.

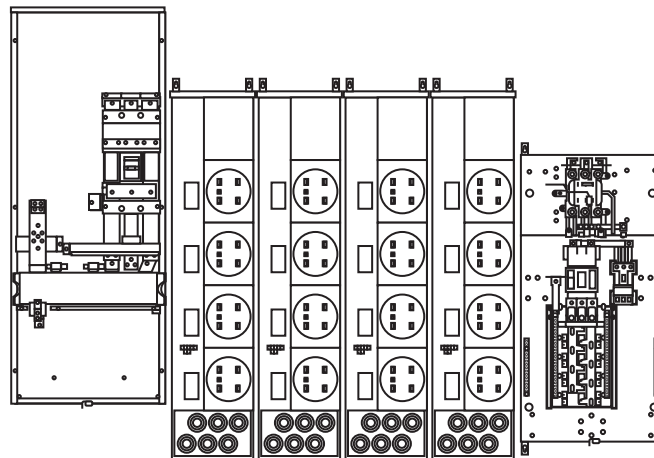

Figure 10

Incoming Service: 1200 Amps

Details: This is the same application as figure 7 shown above, however the WCL house power module now takes the place of both the WML and the P1. The WCL is rated for up to 250A and can accommodate 40 circuits + 1 subfeed breaker of up to 125A. The WCL, in this application, saves over 4 FEET of wall space plus lowers the material cost for the application by 15%! The WCL in this case could also be a WCT or WC. This application simplifies smaller house power needs such as elevators, parking lot lighting, common area lighting, or club houses.

Power Mod

Applications: WTB Tap Boxes 1600 – 2400 Amps (when used with load side tap boxes WT or WTB)

Figure 14

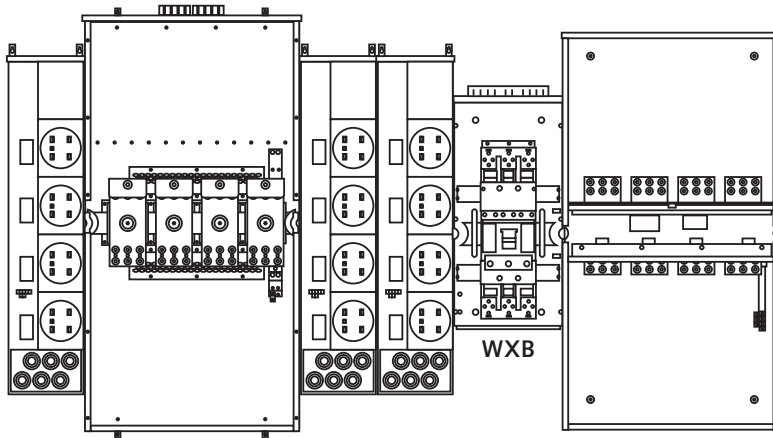

✓ This application shown **IS** allowed because the tap box has circuit protection via the WXB main.

- Siemens Type WL Circuit Breaker
- Class L fuse
- Service Entrance (direct from utility transformer)^①

Figure 15

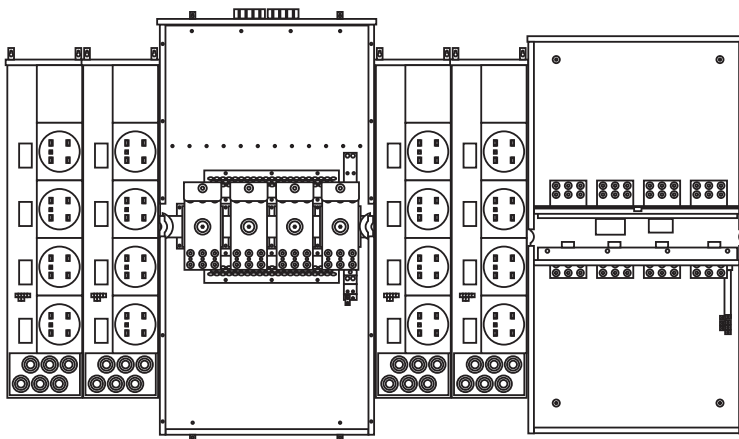

✗ The application shown is **NOT** allowed. A down stream WT or WTB tap box requires circuit protection in the form of a WXB Main.

- Siemens Type WL Circuit Breaker
- Class L fuse
- Service Entrance (direct from utility transformer)^①

^① Drawings are for illustrative purposes only.

Power Mod

Applications: WT Tap Boxes 1600 – 2400 Amps

Figure 16

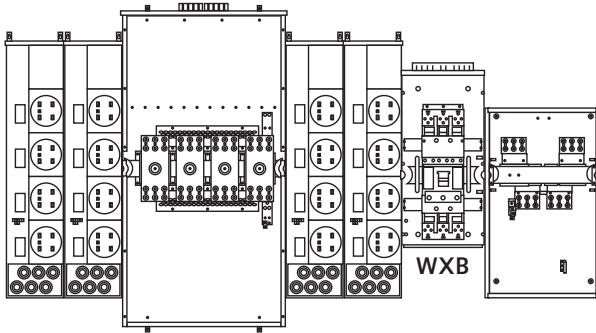

- Siemens Sentron or VL MCCB

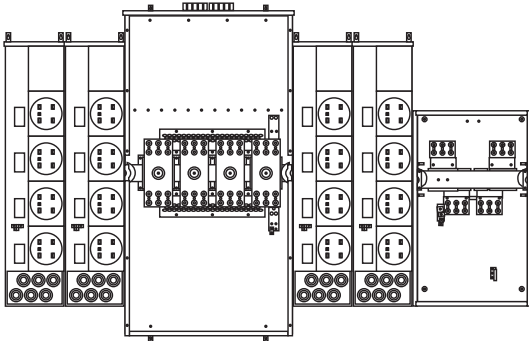

Either of the applications shown are acceptable due to the presence of the VL or Sentron MCBB

Figure 18

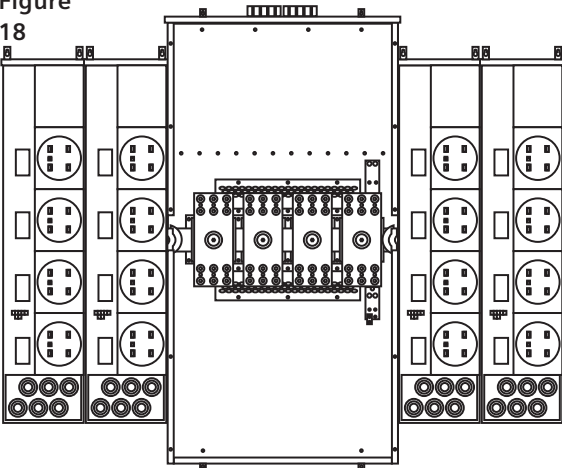

- Service Entrance (direct from utility transformer)^①
- Siemens Type WL circuit breaker

① Drawings are for illustrative purposes only.

Figure 17



The application shown is **NOT** allowed. A down stream WT or WTB tap box requires circuit protection in the form of a WXB Main.

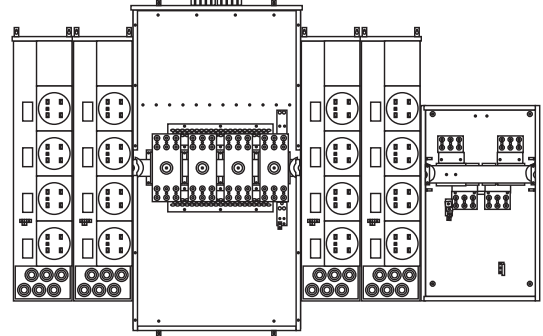

- Class L Fuse

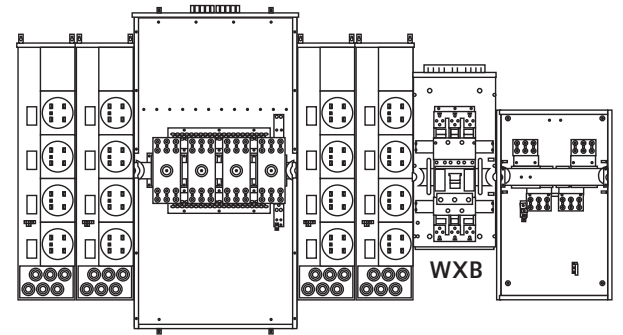

This application shown **IS** allowed because the tap box has circuit protection via the WXB main.



A type WL circuit breaker cannot be used to feed a WT series tap box. Additionally WT tap boxes are not rated for service entrance.

Power Mod

Applications: Bus Duct Connections

Busway application

Siemens Power Mod offers an efficient and standardized means of connecting Sentron Busway to Power Mod utilizing the TapStack module. This module connects to a joint in the busway and converts the bus structure over to that of the Power Mod thru bus in only nine inches.

TapStacks are configured, priced, built, and shipped with the Sentron Busway. They require an additional QuickConnect coupler and are for indoor use on end-feed applications. TapStacks can connect to any Power Mod thru bus.

Options for the user are:

1. Direct Connection: in this option (below) the connection is made directly to any meter stack family. This application is for use when the service disconnect is located at the beginning of the busway.

2. Connection to a service disconnect: in this option a connection is made to either a WXB cross bus main or a WXS switch main. Please note that ANY other mains (WB, WEB, WS, WES) cannot act as a service disconnect for downstream meter stacks. The WB, WEB, WS, WES mains CAN be used as tenant mains on the load-side of a service disconnect for use in feeding large remote loads such as a CT cabinet. WXB mains are available up to 1200A and WXS mains are available up to 800A. Both families have 100K AIC options for all models.

3. Connection to a load-side main: In applications where branch circuit monitoring is used in lieu of Power Mod a tap stack plus Power Mod main (WB, WS) can be used where the installer cables out of the main over to a distribution panel (Siemens P3, P4, and P5 panel types). This essentially replaces a bus plug function.

For Center feed bus duct application please contact your Siemens representative.

Critical and recommended dimensions for Sentron Busway to Power Mod connections

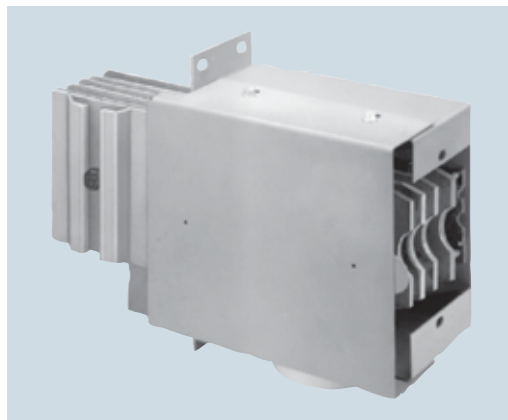
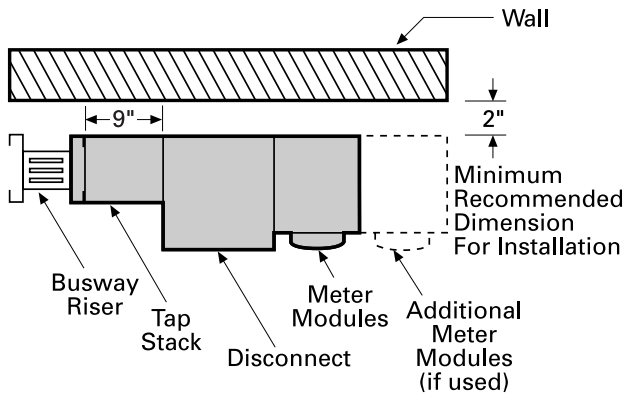

Tap Stack Module

Warning

Do not connect the Power Mod NEMA 1 corner units (BE) directly to busway; always use a WELB in its place or use another module as an intermediary between the two.

Power Mod

Applications: Examples of Busway configurations

Figure 11

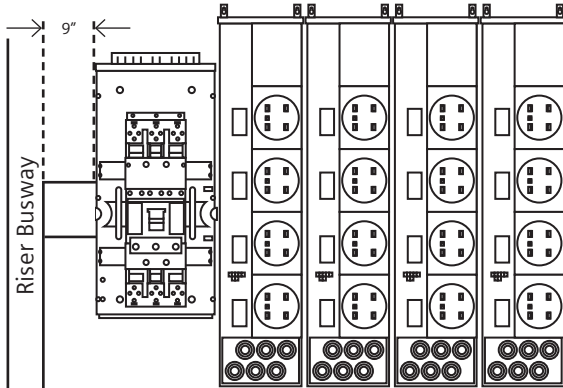

Example of WXB or WXS cross bus mains protecting stacks being fed by busway

Figure 12

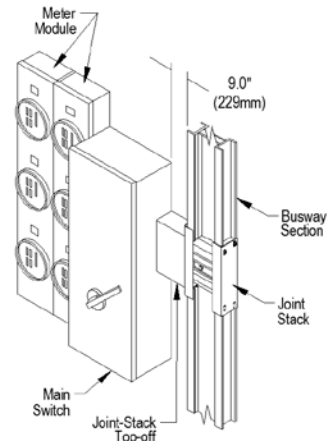
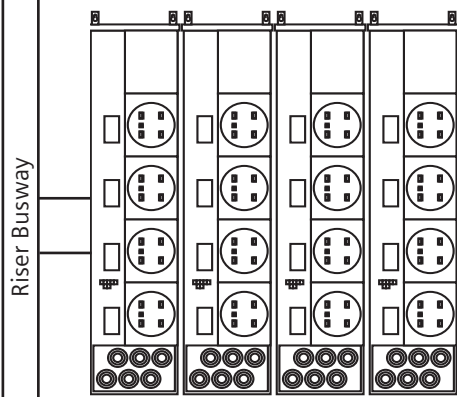
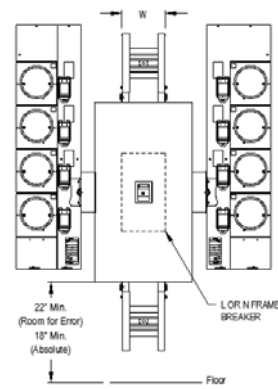

Figure 13



Example of stacks fed by busway tapstack with an upstream main

Figure 14



Example of stacks being fed by a meter center cubicle built inline with busway

Figure 15

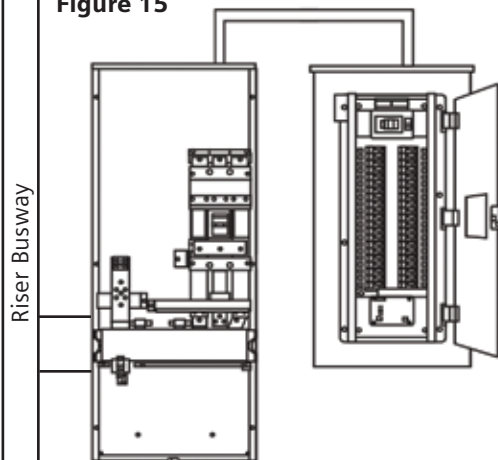

A WB main can be used to back-feed panel board off of busway

Please Note:

- There typically will be an offset off of the wall coming off of busway
- Strut or artificial walls can be used to mount power mod when fed by busway
- When fed by a cubicle tapstacks are not necessary
- Tapstacks are busway products and must be used when connecting Power Mod products to busway when a cubicle is not used
- Tapstacks and cubicles transpose busway phasing to match power mod phasing

Power Mod

Type WB Standard and Skinny Circuit Breaker Mains

Standard and Skinny Circuit Breaker Mains

Standard breaker modules (type WB) offer a balance between functionality, feature, and size constraints.

Features include:

- QuickSystem™ features
- Compression lug landing pads (field install up to 1200 Amps, standard feature up to 2000 Amps)
- Standard Mains offer combination overhead and underground feed up to 1200 Amps as well as dedicated overhead or underground feed up to 2000 Amps
- Skinny Mains offer dedicated feed options, overhead or underground, in modules 200-1200 Amps
- 750kcmil AL wire options
- 65K AIC standard, 100K AIC available for all models
- Removable blank bottom endwall
- Externally accessible breaker handle with padlock capability
- Broad ampacity ratings up to 2000 Amps with non-standard amperages available (such as 700, 900, etc.)
- Field installable shunt trips
- DAS blue light models available in amperages of 1200-1600

Standard and Skinny Circuit Breaker Mains Quick Reference

- 200-2000A module rating
- 1200A thru-bus rating
- UL Standard # UL67
- UL file # E27100
- AIC rating (65k and 100k)
- Voltage:
 - Single phase 120/240V AC max
 - Three phase 240V AC max
- All swing latches and rivets are stainless steel
- NEMA 3R rated
- Custom options now available.
- G90 galvanized steel
- ANSI 61 paint
- Custom options available.

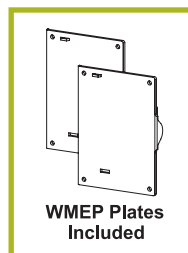

Power Mod

Type WB Standard Circuit Breaker Mains

Suitable for use as service equipment. Certain conditions may apply. See wiring diagram for details.

Lugs are NOT included on 1400A-2000A standard breaker main modules and must be ordered separately.
Refer to pages 92-93 for lug size options.



Standard Mains - Single Phase

Thermal magnetic circuit breaker service entrance modules: 1-phase, 3-wire SN, 120/240V AC

Catalog No. (65k AIC) ^③	Catalog No. (100k AIC) ^{②③}	Catalog No. (65k AIC) Blank Endwall	Catalog No. (100k AIC) Blank Endwall	Amp. Rating	Service Feed	Breaker Type ^⑤	Dimensions (inches) ^①			Factory Installed Line Side Connections	Knockout Diagram
							Height	Width	Depth		
WB1200C ^②	WB1200CU	WB1200CNH	WB1200CUNH	200	OH/UG	JXD6	39.19	15.20	11.03	(2) 3/0-500 kcmil CU (2) 4/0-500 kcmil AL	KB-1
WB1250C ^②	WB1250CU	WB1250CNH	WB1250CUNH	250	OH/UG	JXD6	39.19	15.20	11.03	(2) 3/0-500 kcmil CU (2) 4/0-500 kcmil AL	
WB1300C ^②	WB1300CU	WB1300CNH	WB1300CUNH	300	OH/UG	JXD6	39.19	15.20	11.03	(2) 3/0-500 kcmil CU (2) 4/0-500 kcmil AL	
WB1350C ^②	WB1350CU	WB1350CNH	WB1350CUNH	350	OH/UG	JXD6	39.19	15.20	11.03	(2) 3/0-500 kcmil CU (2) 4/0-500 kcmil AL	
WB1400C	WB1400CU	WB1400CNH	WB1400CUNH	400	OH/UG	JXD6	39.19	15.20	11.03	(2) 3/0-500 kcmil CU (2) 4/0-500 kcmil AL	
WB1450C ^②	WB1450CU	WB1450CNH	WB1450CUNH	450	OH/UG	LXD6	39.19	15.20	11.03	(2) 3/0-500 kcmil CU (2) 4/0-500 kcmil AL	
WB1500C ^②	WB1500CU	WB1500CNH	WB1500CUNH	500	OH/UG	LXD6	39.19	15.20	11.03	(2) 3/0-500 kcmil CU (2) 4/0-500 kcmil AL	
WB1600C	WB1600CU	WB1600CNH	WB1600CUNH	600	OH/UG	LXD6	39.19	15.20	11.03	(2) 3/0-500 kcmil CU (2) 4/0-500 kcmil AL	KB-2
WB1700C ^②	WB1700CU	WB1700CNH	WB1700CUNH	700	OH/UG	MXD6	61.19	24.19	11.03	(3) 1/0-500 kcmil	
WB1800C	WB1800CU	WB1800CNH	WB1800CUNH	800	OH/UG	MXD6	61.19	24.19	11.03	(3) 1/0-500 kcmil	KB-3
WB1900C ^②	WB1900CU	WB1900CNH	WB1900CUNH	900	OH/UG	NXD6	61.19	24.19	11.03	(4) 1/0-500 kcmil	
WB11000C	WB11000CU	WB11000CNH	WB11000CUNH	1000	OH/UG	NXD6	61.19	24.19	11.03	(4) 1/0-500 kcmil	KB-4
WB11200C	WB11200CU	WB11200CNH	WB11200CUNH	1200	OH/UG	NXD6	61.19	24.19	11.03	(4) 1/0-500 kcmil	
WB11400T ^{②④}	WB11400TU ^④	WB11400TNH	WB11400TUNH	1400	OH	PXD6	72.06	31.34	14.66	3 Sets of 2 Studs (lugs not included)	KB-4
WB11400B ^{②④}	WB11400BU ^④	—	—		UG	PXD6	72.06	31.34	14.66		KB-5
WB11600T ^④	WB11600TU ^④	WB11600TNH	WB11600TUNH	1600	OH	PXD6	72.06	31.34	14.66		KB-4
WB11600B ^④	WB11600BU ^④	—	—		UG	PXD6	72.06	31.34	14.66		KB-5
WB11800B ^{②④}	WB11800BU ^④	—	—	1800	UG	RXD6	72.06	31.34	14.66		KB-6
WB11800W	WB11800WU	WB11800WNH	WB11800WUNH		OH/UG	RXD6	72.06	50.56	14.66		KB-5
WB12000B ^④	WB12000BU ^④	—	—	2000	UG	RXD6	72.06	31.34	14.66		KB-5
WB12000W ^{②④}	WB12000WU ^④	WB12000WNH	WB12000WUNH		OH/UG	RXD6	72.06	50.56	14.66		KB-6

DAS electronic circuit breaker service entrance modules with blue light maintenance mode: 1-phase, 3 wire SN, 120/240V AC

Catalog No. (65k AIC) ^③	Catalog No. (100k AIC) ^{②③}	Catalog No. (65k AIC) Blank Endwall	Catalog No. (100k AIC) Blank Endwall	Amp. Rating	Service Feed	Breaker Type ^⑤	Dimensions (inches) ^①			Factory Installed Line Side Connections	Knockout Diagram
							Height	Width	Depth		
WBM11200C	WBM11200CU	WBM11200CNH	WBM11200CUNH	1200	OH/UG	SND6	61.19	24.19	11.03	(4) 1/0-500 kcmil	KB-3
WBM11400T	WBM11400TU	WBM11400TNH	WBM11400TUNH	1400	OH	SND6	72.06	31.34	14.66	3 Sets of 2 Studs (lugs not included)	KB-4
WBM11400B	WBM11400BU	—	—	1400	OH	SND6	72.06	31.34	14.66		KB-5
WBM11600T	WBM11600TU	WBM11600TNH	WBM11600TUNH	1600	UG	SND6	72.06	31.34	14.66		KB-4
WBM11600B	WBM11600BU	—	—	1600	UG	SND6	72.06	31.34	14.66		KB-5

① Dimensions shown are representative of outside box dimensions and do not include allowances for mounting bumps, endwalls, covers, hubs, or hardware protrusions. Dimensions are subject to change.
② Additional lead time required. Contact sales office for details. 100K and non-standard amperage modules.

③ Factory installed lugs standard on 200-1200A standard breaker main modules. Additional lug kit options available for 750 conductor size. Field installable compression lug landing pad also available. NEMA II Stud Pattern compression lugs must be installed by user or utility. Lugs NOT included on 1400A-2000A standard breaker main modules and must be ordered separately.

④ 1200 amp maximum feed per side-must be used as a center fed main.
⑤ All breakers have a non-interchangeable trip unit.

Power Mod

Type WB Standard Circuit Breaker Mains

Suitable for use as service equipment. Certain conditions may apply. See wiring diagram for details.

Lugs are NOT included on 1400A-2000A standard breaker main modules and must be ordered separately.

Refer to pages 92-93 for lug size options.



Standard Mains - Three Phase

Thermal magnetic circuit breaker service entrance modules: 3-phase, 4-wire SN, 240V AC max

Catalog No. (65k AIC) ^③	Catalog No. (100k AIC) ^{②③}	Catalog No. (65k AIC) Blank Endwall	Catalog No. (100k AIC) Blank Endwall	Amp. Rating	Service Feed	Breaker Type ^⑤	Dimensions (inches) ^①			Factory Installed Line Side Connections	Knockout Diagram
							Height	Width	Depth		
WB3200C ^②	WB3200CU	WB3200CNH	WB3200CUNH	200	OH/UG	JXD6	39.19	15.20	11.03	(2) 3/0-500 kcmil CU (2) 4/0-500 kcmil AL	KB-1
WB3250C ^②	WB3250CU	WB3250CNH	WB3250CUNH	250	OH/UG	JXD6	39.19	15.20	11.03	(2) 3/0-500 kcmil CU (2) 4/0-500 kcmil AL	
WB3300C ^②	WB3300CU	WB3300CNH	WB3300CUNH	300	OH/UG	JXD6	39.19	15.20	11.03	(2) 3/0-500 kcmil CU (2) 4/0-500 kcmil AL	
WB3350C ^②	WB3350CU	WB3350CNH	WB3350CUNH	350	OH/UG	JXD6	39.19	15.20	11.03	(2) 3/0-500 kcmil CU (2) 4/0-500 kcmil AL	
WB3400C	WB3400CU	WB3400CNH	WB3400CUNH	400	OH/UG	JXD6	39.19	15.20	11.03	(2) 3/0-500 kcmil CU (2) 4/0-500 kcmil AL	
WB3450C ^②	WB3450CU	WB3450CNH	WB3450CUNH	450	OH/UG	LXD6	39.19	15.20	11.03	(2) 3/0-500 kcmil CU (2) 4/0-500 kcmil AL	
WB3500C ^②	WB3500CU	WB3500CNH	WB3500CUNH	500	OH/UG	LXD6	39.19	15.20	11.03	(2) 3/0-500 kcmil CU (2) 4/0-500 kcmil AL	
WB3600C	WB3600CU	WB3600CNH	WB3600CUNH	600	OH/UG	LXD6	39.19	15.20	11.03	(2) 3/0-500 kcmil CU (2) 4/0-500 kcmil AL	KB-2
WB3700C ^②	WB3700CU	WB3700CNH	WB3700CUNH	700	OH/UG	MXD6	61.19	24.19	11.03	(3) 1/0-500 kcmil	
WB3800C	WB3800CU	WB3800CNH	WB3800CUNH	800	OH/UG	MXD6	61.19	24.19	11.03	(3) 1/0-500 kcmil	
WB3900C ^②	WB3900CU	WB3900CNH	WB3900CUNH	900	OH/UG	NXD6	61.19	24.19	11.03	(4) 1/0-500 kcmil	KB-3
WB31000C	WB31000CU	WB31000CNH	WB31000CUNH	1000	OH/UG	NXD6	61.19	24.19	11.03	(4) 1/0-500 kcmil	
WB31200C	WB31200CU	WB31200CNH	WB31200CUNH	1200	OH/UG	NXD6	61.19	24.19	11.03	(4) 1/0-500 kcmil	3 Sets of 2 Studs  (lugs not included)
WB31400T ^{②④}	WB31400TU ^④	WB31400TNH	WB31400TUNH	1400	OH	PXD6	72.06	31.34	14.66		
WB31400B ^{②④}	WB31400BU ^④	—	—		UG	PXD6	72.06	31.34	14.66		
WB31600T ^④	WB31600TU ^④	WB31600TNH	WB31600TUNH	1600	OH	PXD6	72.06	31.34	14.66		
WB31600B ^④	WB31600BU ^④	—	—		UG	PXD6	72.06	31.34	14.66		
WB31800B ^{②④}	WB31800BU ^④	—	—	1800	UG	RXD6	72.06	31.34	14.66		
WB31800W	WB31800WU	WB31800WNH	WB31800WUNH		OH/UG	RXD6	72.06	50.56	14.66		
WB32000B ^{③④}	WB32000BU ^④	—	—	2000	UG	RXD6	72.06	31.34	14.66		
WB32000W ^{②④}	WB32000WU ^④	WB32000WNH	WB32000WUNH		OH/UG	RXD6	72.06	50.56	14.66		

DAS electronic circuit breaker service entrance modules with blue light maintenance mode: 3-phase, 4 wire SN, 240V AC max

Catalog No. (65k AIC) ^③	Catalog No. (100k AIC) ^{②③}	Catalog No. (65k AIC) Blank Endwall	Catalog No. (100k AIC) Blank Endwall	Amp. Rating	Service Feed	Breaker Type ^⑤	Dimensions (inches) ^①			Factory Installed Line Side Connections	Knockout Diagram
							Height	Width	Depth		
WBM31200C	WBM31200CU	WBM31200CNH	WBM31200CUNH	1200	OH/UG	SND6	61.19	24.19	11.03	(4) 1/0-500 kcmil	KB-3
WBM31400T	WBM31400TU	WBM31400TNH	WBM31400TUNH	1400	OH	SND6	72.06	31.34	14.66	3 Sets of 2 Studs  (lugs not included)	KB-4
WBM31400B	WBM31400BU	—	—	1400	OH	SND6	72.06	31.34	14.66		KB-5
WBM31600T	WBM31600TU	WBM31600TNH	WBM31600TUNH	1600	UG	SND6	72.06	31.34	14.66		KB-4
WBM31600B	WBM31600BU	—	—	1600	UG	SND6	72.06	31.34	14.66		KB-5

① Dimensions shown are representative of outside box dimensions and do not include allowances for mounting bumps, endwalls, covers, hubs, or hardware protrusions. Dimensions are subject to change.

② Additional lead time required. Contact sales office for details. 100K and non-standard amperage modules.

③ Factory installed lugs standard on 200-1200A standard breaker main modules. Additional lug kit options available for 750 conductor size. Field installable compression lug landing pad also available. NEMA II Stud Pattern compression lugs must be installed by user or utility. Lugs NOT included on 1400A-2000A standard breaker main modules and must be ordered separately.

④ 1200 amp maximum feed per side-must be used as a center fed main.

⑤ All breakers have a non-interchangeable trip unit.

Power Mod

Type WB Skinny Circuit Breaker Mains with Dedicated Feed Direction

Suitable for use as service equipment. Certain conditions may apply. See wiring diagram for details.

Skinny Mains are narrower than standard WB mains because they require a predetermined dedicated feed direction; either top feed or bottom feed. This direction must be known prior to selecting the unit. If feed direction is unknown, use a combination feed unit from previous pages.



Skinny Mains - Single Phase

Skinny thermal magnetic circuit breaker service entrance modules: 1-phase, 3-wire SN, 120/240V AC

Catalog No. (65k AIC)	Catalog No. (100k AIC) ^②	Catalog No. (65k AIC) Blank Endwall	Catalog No. (100k AIC) Blank Endwall ^②	Amp Rating	Service Feed	Breaker Type ^④	Dimensions (inches) ^①			Factory Installed Line Side Connections ^③					
							Height	Width	Depth						
WB1200T	WB1200TU	WB1200TNH	WB1200TUNH	200	Top	JXD6	45.06	9.56	11	(2) 3/0-500 kcmil CU (2) 4/0-500 kcmil AL					
WB1200B	WB1200BU	—	—	200	Bottom										
WB1250T	WB1250TU	WB1250TNH	WB1250TUNH	250	Top										
WB1250B	WB1250BU	—	—	250	Bottom										
WB1300T	WB1300TU	WB1300TNH	WB1300TUNH	300	Top										
WB1300B	WB1300BU	—	—	300	Bottom										
WB1350T	WB1350TU	WB1350TNH	WB1350TUNH	350	Top										
WB1350B	WB1350BU	—	—	350	Bottom										
WB1400T	WB1400TU	WB1400TNH	WB1400TUNH	400	Top										
WB1400B	WB1400BU	—	—	400	Bottom										
WB1450T	WB1450TU	WB1450TNH	WB1450TUNH	450	Top						LXD6	58.56	11.06	13.25	(3) 1/0-500 kcmil
WB1450B	WB1450BU	—	—	450	Bottom										
WB1500T	WB1500TU	WB1500TNH	WB1500TUNH	500	Top										
WB1500B	WB1500BU	—	—	500	Bottom										
WB1600T	WB1600TU	WB1600TNH	WB1600TUNH	600	Top										
WB1600B	WB1600BU	—	—	600	Bottom										
WB1700T	WB1700TU	WB1700TNH	WB1700TUNH	700	Top	MXD6	58.56	11.06	13.25	(4) 1/0-500 kcmil					
WB1700B	WB1700BU	—	—	700	Bottom										
WB1800T	WB1800TU	WB1800TNH	WB1800TUNH	800	Top										
WB1800B	WB1800BU	—	—	800	Bottom	NXD6	58.56	11.06	13.25	(4) 1/0-500 kcmil					
WB1900T	WB1900TU	WB1900TNH	WB1900TUNH	900	Top										
WB1900B	WB1900BU	—	—	900	Bottom										
WB11000T	WB11000TU	WB11000TNH	WB11000TUNH	1000	Top										
WB11000B	WB11000BU	—	—	1000	Bottom										
WB11200T	WB11200TU	WB11200TNH	WB11200TUNH	1200	Top										
WB11200B	WB11200BU	—	—	1200	Bottom										

Skinny DAS electronic circuit breaker service entrance modules with blue light: 1-phase, 3 wire SN, 120/240V AC^③

Catalog No. (65k AIC)	Catalog No. (100k AIC) ^②	Catalog No. (65k AIC) Blank Endwall	Catalog No. (100k AIC) Blank Endwall ^②	Amp Rating	Service Feed	Breaker Type ^④	Dimensions (inches) ^①			Factory Installed Line Side Connections ^③
							Height	Width	Depth	
WBM11200T	WBM11200TU	WBM11200TNH	WBM11200TUNH	1200	Top	SND6	58.56	11.06	13.25	(4) 1/0-500 kcmil
WBM11200B	WBM11200BU	—	—	1200	Bottom	SND6	64.56			



Caution: Feed direction is not changeable in the field. Only select a Skinny Main if feed direction is certain. If feed direction is not certain, use combination feed mains found on pages 21-22.

① Dimensions shown are representative of outside box dimensions and do not include allowances for mounting bumps, endwalls, covers, hubs, or hardware protrusions. Dimensions are subject to change.

② Additional lead time required. Contact sales office for details. 100K and non-standard amperage modules.

③ Factory installed lugs standard on 200-1200A standard breaker main modules. Additional lug kit options available for 750 conductor size.

④ All breakers have a non-interchangeable trip unit.

⑤ Skinny Mains are non-compatible with the lug landing pads LLP600 and LLP1200.

Power Mod

Type WB Skinny Circuit Breaker Mains with Dedicated Feed Direction

Suitable for use as service equipment. Certain conditions may apply. See wiring diagram for details.

Skinny Mains are narrower than standard WB mains because they require a predetermined dedicated feed direction; either top feed or bottom feed. This direction must be known prior to selecting the unit. If feed direction is unknown, use a combination feed unit from previous pages.



Skinny Mains - Three Phase

Skinny thermal magnetic circuit breaker service entrance modules: 3-phase, 4-wire SN, 240V AC max

Catalog No. (65k AIC)	Catalog No. (100k AIC)®	Catalog No. (65k AIC) Blank Endwall	Catalog No. (100k AIC) Blank Endwall®	Amp Rating	Service Feed	Breaker Type④	Dimensions (inches)①			Factory Installed Line Side Connections⑤					
							Height	Width	Depth						
WB3200T	WB3200TU	WB3200TNH	WB3200TUNH	200	Top	JXD6	45.06	9.56	11	(2) 3/0-500 kcmil CU (2) 4/0-500 kcmil AL					
WB3200B	WB3200BU	—	—	200	Bottom										
WB3250T	WB3250TU	WB3250TNH	WB3250TUNH	250	Top										
WB3250B	WB3250BU	—	—	250	Bottom										
WB3300T	WB3300TU	WB3300TNH	WB3300TUNH	300	Top										
WB3300B	WB3300BU	—	—	300	Bottom										
WB3350T	WB3350TU	WB3350TNH	WB3350TUNH	350	Top										
WB3350B	WB3350BU	—	—	350	Bottom										
WB3400T	WB3400TU	WB3400TNH	WB3400TUNH	400	Top										
WB3400B	WB3400BU	—	—	400	Bottom										
WB3450T	WB3450TU	WB3450TNH	WB3450TUNH	450	Top						LXD6	58.56	11.06	13.25	(3) 1/0-500 kcmil
WB3450B	WB3450BU	—	—	450	Bottom										
WB3500T	WB3500TU	WB3500TNH	WB3500TUNH	500	Top										
WB3500B	WB3500BU	—	—	500	Bottom										
WB3600T	WB3600TU	WB3600TNH	WB3600TUNH	600	Top										
WB3600B	WB3600BU	—	—	600	Bottom										
WB3700T	WB3700TU	WB3700TNH	WB3700TUNH	700	Top	MXD6	58.56	11.06	13.25	(4) 1/0-500 kcmil					
WB3700B	WB3700BU	—	—	700	Bottom										
WB3800T	WB3800TU	WB3800TNH	WB3800TUNH	800	Top										
WB3800B	WB3800BU	—	—	800	Bottom	NXD6	58.56	11.06	13.25	(4) 1/0-500 kcmil					
WB3900T	WB3900TU	WB3900TNH	WB3900TUNH	900	Top										
WB3900B	WB3900BU	—	—	900	Bottom										
WB31000T	WB31000TU	WB31000TNH	WB31000TUNH	1000	Top										
WB31000B	WB31000BU	—	—	1000	Bottom										
WB31200T	WB31200TU	WB31200TNH	WB31200TUNH	1200	Top										
WB31200B	WB31200BU	—	—	1200	Bottom										

Skinny DAS electronic circuit breaker service entrance modules with blue light: 3-phase, 4 wire SN, 240V AC max

Catalog No. (65k AIC)	Catalog No. (100k AIC)®	Catalog No. (65k AIC) Blank Endwall	Catalog No. (100k AIC) Blank Endwall®	Amp Rating	Service Feed	Breaker Type④	Dimensions (inches)①			Factory Installed Line Side Connections⑤
							Height	Width	Depth	
WBM31200T	WBM31200TU	WBM31200TNH	WBM31200TUNH	1200	Top	SND6	58.56	11.06	13.25	(4) 1/0-500 kcmil
WBM31200B	WBM31200BU	—	—	1200	Bottom	SND6	64.56			



Caution: Feed direction is not changeable in the field. Only select a Skinny Main if feed direction is certain. If feed direction is not certain, use combination feed mains found on pages 21-22.

① Dimensions shown are representative of outside box dimensions and do not include allowances for mounting bumps, endwalls, covers, hubs, or hardware protrusions. Dimensions are subject to change.

② Additional lead time required. Contact sales office for details. 100K and non-standard amperage modules.

③ Factory installed lugs standard on 200-1200A standard breaker main modules. Additional lug kit options available for 750 conductor size.

④ All breakers have a non-interchangeable trip unit.

⑤ Skinny Mains are non-compatible with the lug landing pads LLP600 and LLP1200.

Power Mod

Type WEB Circuit Breaker – Pullbox Combinations

Circuit Breaker – Pullbox Combinations

EUSERC – compliant breaker – pullbox combination modules (type WEB) offer EUSERC compatibility, a wider range of lug options, and extra space for pulling in conductors.

Features include:

- QuickSystem™ features
- Factory installed NEMA II studs
- 750 kcmil AL wire options
- 65K AIC standard, 100K AIC available for all models
- Removable blank bottom endwall
- Externally accessible breaker handle with padlock capability
- Field installable shunt trips
- Large removable ground wire trough with generous space for grounding conductors
- DAS blue light models available in 1200 Amps

Circuit Breaker-Pullbox Combinations Quick Reference

- 200-1200A module rating
- 1200A thru-bus
- UL standard # UL67
- UL file # E27100
- AIC rating (65k and 100k)
- Voltage
 - Single phase 120/240V AC max
 - Three phase 240V AC max
- All swing latches and rivets are stainless steel
- NEMA 3R rated
- G90 galvanized steel
- ANSI 61 paint
- EUSERC drawing number 347
- Custom options available.

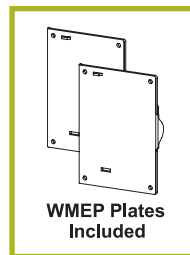

Power Mod



Type WEB Circuit Breaker – Pullbox Combinations

Suitable for use as service equipment. Certain conditions may apply. See wiring diagram for details.

Lugs are NOT included and must be ordered separately.
Refer to pages 92-93 for lug size options.



Thermal magnetic combination circuit breaker and pullbox modules: 1-phase, 3-wire SN, 120/240V AC max, meets EUSERC requirements

Catalog No. (65k AIC)	Catalog No. (100k AIC) ^②	Ampere Rating	Service Feed	Breaker Type ^④	Dimensions (inches) ^①			Line Side ^③ Connections (lugs not included)	Knockout Diagram
					Height	Width	Depth		
WEB1200B ^②	WEB1200BU	200	UG	JXD6	54.88	28.28	13.06	1 set of 2 studs 	EB-1
WEB1250B ^②	WEB1250BU	250	UG	JXD6	54.88	28.28	13.06		
WEB1300B ^②	WEB1300BU	300	UG	JXD6	54.88	28.28	13.06		
WEB1350B ^②	WEB1350BU	350	UG	JXD6	54.88	28.28	13.06		
WEB1400B	WEB1400BU	400	UG	JXD6	54.88	28.28	13.06		
WEB1500B ^②	WEB1500BU	500	UG	LXD6	54.88	28.88	13.06	2 sets of 2 studs 	EB-2
WEB1600B	WEB1600BU	600	UG	LXD6	54.88	28.28	13.06		
WEB1700B ^②	WEB1700BU	700	UG	MXD6	59.34	34.22	12.47	3 sets of 2 studs 	EB-3
WEB1800B	WEB1800BU	800	UG	MXD6	59.34	34.22	12.47		
WEB1900B ^②	WEB1900BU	900	UG	NXD6	59.34	34.22	12.47		
WEB11000B	WEB11000BU	1000	UG	NXD6	59.34	34.22	12.47		
WEB11200B	WEB11200BU	1200	UG	NXD6	59.34	34.22	12.47		

DAS electronic combination circuit breaker and pullbox modules with blue light maintenance mode: 1-phase, 3-wire SN, 120/240V AC max, meets EUSERC requirements

Catalog No. (65k AIC)	Catalog No. (100k AIC) ^②	Ampere Rating	Service Feed	Breaker Type ^④	Dimensions (inches) ^①			Line Side ^③ Connections (lugs not included)	Knockout Diagram
					Height	Width	Depth		
WEBM11200B	WEBM11200BU	1200	UG	SND6	59.34	34.22	12.47	3 sets of 2 studs 	EB-3

① Dimensions shown are representative of outside box dimensions and do not include allowances for mounting bumps, endwalls, covers, hubs, or hardware protrusions. Dimensions are subject to change.

② Additional lead time required. Contact sales office for details. Non-standard modules

③ Lugs not included. Refer to pages 92-93 for lug size options. 750 conductor size available. NEMA II stud pattern compression lugs must be installed by user or utility.
④ All breakers have a non-interchangeable trip unit.

Power Mod

Type WEB Circuit Breaker - Pullbox Combinations



Suitable for use as service equipment. Certain conditions may apply. See wiring diagram for details.

Lugs are NOT included and must be ordered separately.

Refer to pages 92-93 for lug size options.



Thermal magnetic combination circuit breaker and pullbox modules: 3-phase, 4-wire SN, 240V AC max, meets EUSERC requirements

Catalog No. (65k AIC)	Catalog No. (100k AIC) ^②	Ampere Rating	Service Feed	Breaker Type ^④	Dimensions (inches) ^①			Line Side ^③ Connections (lugs not included)	Knockout Diagram
					Height	Width	Depth		
WEB3200B ^②	WEB3200BU	200	UG	JXD6	54.88	28.28	13.06	1 set of 2 studs 	EB-1
WEB3250B ^②	WEB3250BU	250	UG	JXD6	54.88	28.28	13.06		
WEB3300B ^②	WEB3300BU	300	UG	JXD6	54.88	28.28	13.06		
WEB3350B ^②	WEB3350BU	350	UG	JXD6	54.88	28.28	13.06		
WEB3400B	WEB3400BU	400	UG	JXD6	54.88	28.28	13.06		
WEB3500B ^②	WEB3500BU	500	UG	LXD6	54.88	28.28	13.06	2 sets of 2 studs 	EB-2
WEB3600B	WEB3600BU	600	UG	LXD6	54.88	28.28	13.06		
WEB3700B ^②	WEB3700BU	700	UG	MXD6	59.34	34.22	12.47	3 sets of 2 studs 	EB-3
WEB3800B	WEB3800BU	800	UG	MXD6	59.34	34.22	12.47		
WEB3900B ^②	WEB3900BU	900	UG	NXD6	59.34	34.22	12.47		
WEB31000B	WEB31000BU	1000	UG	NXD6	59.34	34.22	12.47		
WEB31200B	WEB31200BU	1200	UG	NXD6	59.34	34.22	12.47		

DAS electronic combination circuit breaker and pullbox modules with blue light maintenance mode: 3-phase, 4-wire SN, 240V AC max, meets EUSERC requirements

Catalog No. (65k AIC)	Catalog No. (100k AIC) ^②	Ampere Rating	Service Feed	Breaker Type ^④	Dimensions (inches) ^①			Line Side ^③ Connections (lugs not included)	Knockout Diagram
					Height	Width	Depth		
WEBM31200B	WEBM31200BU	1200	UG	SND6	59.34	34.22	12.47	3 sets of 2 studs 	EB-3

^① Dimensions shown are representative of outside box dimensions and do not include allowances for mounting bumps, endwalls, covers, hubs, or hardware protrusions. Dimensions are subject to change.

^② Additional lead time required. Contact sales office for details. Non-standard modules

^③ Lugs not included. Refer to pages 92-93 for lug size options. 750 conductor size available. NEMA II stud pattern compression lugs must be installed by user or utility.
^④ All breakers have a non-interchangeable trip unit.

Power Mod

Type WXB Main Units

Cross Bus Main modules

Cross Bus Main modules (type WXB) offer two distinct functions: first they can be used to connect Siemens Sentron Busway to a Power Mod line-up. Second they can be utilized to offer lower service disconnect ampacities or unique configurations where an incoming tap box is preferred. See application pages for examples.

Features include:

- QuickSystem™ features
- Incoming and outgoing bus connections (right to left or left to right)
- Standardized connection points to Siemens Sentron Busway
- 65K AIC standard, 100K AIC available for all models
- Externally accessible breaker handle with padlock capability
- Broad ampacity ratings up to 1200 Amps with non-standard amperages available (such as 700, 900, etc.)
- Field installable shunt trips

Circuit Breaker-Pullbox Combinations Quick Reference

- 400-1200A module rating
- 1200A thru-bus rating
- UL Standard # UL67
- UL file # E27100
- AIC rating (65k and 100k)
- Voltage:
 - Single phase 120/240V AC max
 - Three phase 240V AC max
- All swing latches and rivets are stainless steel
- NEMA 3R rated
- G90 galvanized steel
- ANSI 61 paint
- Custom options available.

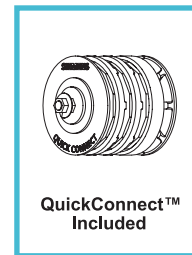
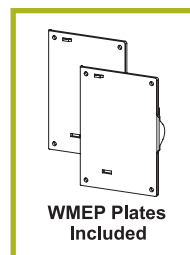

Power Mod

Type WXB Main Units

Not for use as service equipment.

Connects via thru
bussing only -
NO LUGS



1-phase, 3-wire SN, 120/240V AC^②

Catalog No. (65k AIC)	Catalog No. (100k AIC) ^①	Ampere Rating	Service Feed	Breaker Type	Dimensions ^①			Knockout Diagram
					Height	Width	Depth	
WXB1200N ^③	WXB1200NU	200	Thru Bus	JXD6	27.05	15.59	10.82	WXB-1
WXB1250N ^③	WXB1250NU	250	Thru Bus	JXD6	27.05	15.59	10.82	
WXB1300N ^③	WXB1300NU	300	Thru Bus	JXD6	27.05	15.59	10.82	
WXB1350N ^③	WXB1350NU	350	Thru Bus	JXD6	27.05	15.59	10.82	
WXB1400N	WXB1400NU	400	Thru Bus	JXD6	27.05	15.59	10.82	
WXB1450N ^③	WXB1450NU	450	Thru Bus	LXD6	27.05	15.59	10.82	
WXB1500N ^③	WXB1500NU	500	Thru Bus	LXD6	27.05	15.59	10.82	WXB-2
WXB1600N	WXB1600NU	600	Thru Bus	LXD6	27.05	15.59	10.82	
WXB1700N ^③	WXB1700NU	700	Thru Bus	MXD6	36.05	18.13	12.63	WXB-2
WXB1800N	WXB1800NU	800	Thru Bus	MXD6	36.05	18.13	12.63	
WXB1900N ^③	WXB1900NU	900	Thru Bus	NXD6	36.05	18.13	12.63	WXB-3
WXB11000N	WXB11000NU	1000	Thru Bus	NXD6	36.05	18.13	12.63	
WXB11200N	WXB11200NU	1200	Thru Bus	NXD6	36.05	18.13	12.63	

3-phase, 4-wire SN, 240V AC max^②

Catalog No. (65k AIC)	Catalog No. (100k AIC) ^③	Ampere Rating	Service Feed	Breaker Type	Dimensions ^①			Knockout Diagram
					Height	Width	Depth	
WXB3200N ^③	WXB3200NU	200	Thru Bus	JXD6	27.05	15.59	10.82	WXB-1
WXB3250N ^③	WXB3250NU	250	Thru Bus	JXD6	27.05	15.59	10.82	
WXB3300N ^③	WXB3300NU	300	Thru Bus	JXD6	27.05	15.59	10.82	
WXB3350N ^③	WXB3350NU	350	Thru Bus	JXD6	27.05	15.59	10.82	
WXB3400N	WXB3400NU	400	Thru Bus	JXD6	27.05	15.59	10.82	
WXB3450N ^③	WXB3450NU	450	Thru Bus	LXD6	27.05	15.59	10.82	
WXB3500N ^③	WXB3500NU	500	Thru Bus	LXD6	27.05	15.59	10.82	WXB-2
WXB3600N	WXB3600NU	600	Thru Bus	LXD6	27.05	15.59	10.82	
WXB3700N ^③	WXB3700NU	700	Thru Bus	MXD6	36.05	18.13	12.63	WXB-2
WXB3800N	WXB3800NU	800	Thru Bus	MXD6	36.05	18.13	12.63	
WXB3900N ^③	WXB3900NU	900	Thru Bus	NXD6	36.05	18.13	12.63	WXB-3
WXB31000N	WXB31000NU	1000	Thru Bus	NXD6	36.05	18.13	12.63	
WXB31200N	WXB31200NU	1200	Thru Bus	NXD6	36.05	18.13	12.63	

^① Dimensions shown are representative of outside box dimensions and do not include allowances for mounting bumps, endwalls, covers, hubs, or hardware protrusions. Dimensions are subject to change.

^② Connects via thru bussing only.

^③ Non Standard item – extended lead time applies

Power Mod

Type WBT Feed Thru Tap Box with Horizontal Bus Breaker

WBT - Feed Thru Tap Box with Breaker

The feed thru tap box with breaker (type WBT) offers the ability to pull conductors in and out of the enclosure for rise cable or loop feed applications as well as a main breaker device utilizing an incoming and out-going thru bus connections (including incoming lugs). In addition users don't have to utilize any additional tap boxes as lugs are already included in the units. This can save the end-user on the material cost of the meter bank. Please see the applications pages for more information.

Features include:

- QuickSystem™ features
- Incoming and Outgoing Power Mod thru bus
- Standard compression lug capability
- 65K AIC standard, 100K AIC available for all models
- Broad ampacity ratings from 1200-2000 Amps
- Field installable shunt trip

Feed Thru Tap Box with Breaker Quick Reference

- 200-1200A (breaker)
- 1200-2400A (feed thru)
- 1200 thru-bus rating
- UL Standard #67
- UL file #E27100
- AIC rating (65K and 100K)
- Voltage:
 - Three Phase 240V AC max
- All swing latches and rivets are stainless steel
- NEMA 3R (outdoor)
- G90 galvanized steel
- ANSI 61 paint

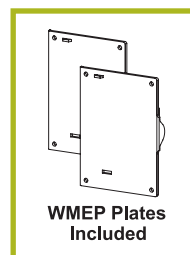
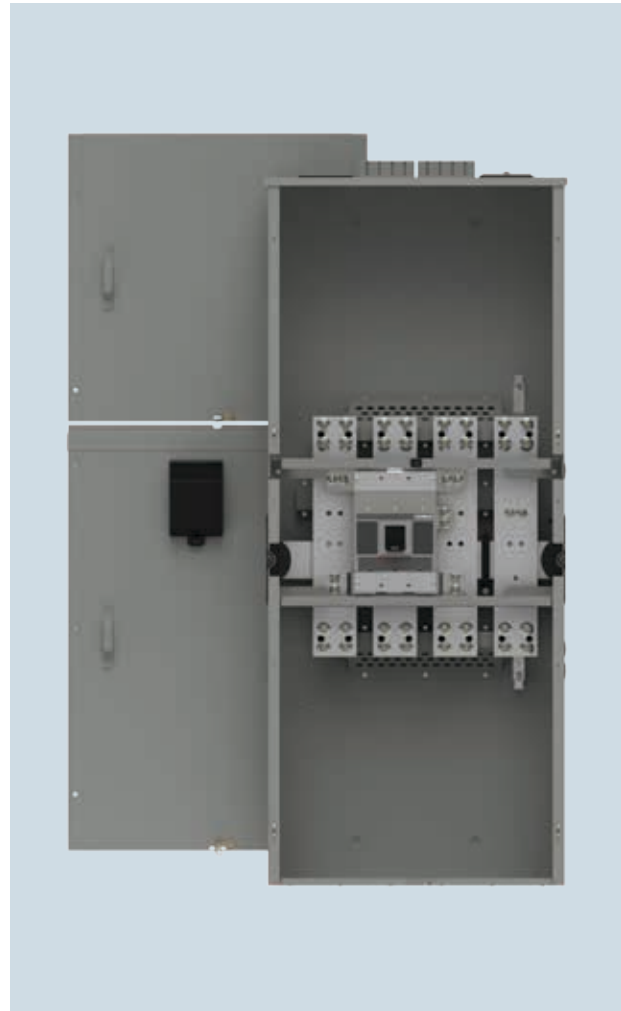

Power Mod

Type WBT Feed Thru Tap Box with Horizontal Bus Breaker

Connects via lugs.

Lug kits not included. Lug kits must be ordered separately per module.

Refer to pages 92-93 for lug size options.

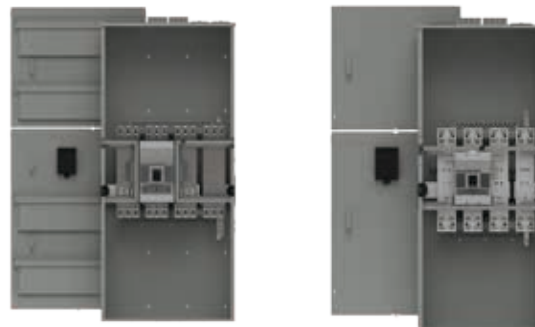

Not for use as service equipment.

3-phase, 4-wire SN, 240V AC Max.

Catalog No. (65k AIC)	Catalog No. (100k AIC) ^②	Catalog No. (65k AIC) Blank Endwall	Catalog No. (100k AIC) ^② Blank Endwall	Breaker Amperage Rating	Feed Through Bus Rating	Breaker Type	Dimensions (inches) ^①		
							Height	Width	Depth
WBT312X200	WBT312X200U	WBT312X200NH	WBT312X200UNH	200	1200	JXD6	66.21	27.59	13.30
WBT312X250	WBT312X250U	WBT312X250NH	WBT312X250UNH	250	1200	JXD6	66.21	27.59	13.30
WBT312X300	WBT312X300U	WBT312X300NH	WBT312X300UNH	300	1200	JXD6	66.21	27.59	13.30
WBT312X350	WBT312X350U	WBT312X350NH	WBT312X350UNH	350	1200	JXD6	66.21	27.59	13.30
WBT312X400	WBT312X400U	WBT312X400NH	WBT312X400UNH	400	1200	JXD6	66.21	27.59	13.30
WBT312X450	WBT312X450U	WBT312X450NH	WBT312X450UNH	450	1200	JXD6	66.21	27.59	13.30
WBT312X500	WBT312X500U	WBT312X500NH	WBT312X500UNH	500	1200	LXD6	66.21	27.59	13.30
WBT312X600	WBT312X600U	WBT312X600NH	WBT312X600UNH	600	1200	LXD6	66.21	27.59	13.30
WBT324X700	WBT324X700U	WBT324X700NH	WBT324X700UNH	700	2400	MXD6	79.75	35.55	16.96
WBT324X800	WBT324X800U	WBT324X800NH	WBT324X800UNH	800	2400	MXD6	79.75	35.55	16.96
WBT324X900	WBT324X900U	WBT324X900NH	WBT324X900UNH	900	2400	NXD6	79.75	35.55	16.96
WBT324X1000	WBT324X1000U	WBT324X1000NH	WBT324X1000UNH	1000	2400	NXD6	79.75	35.55	16.96
WBT324X1200	WBT324X1200U	WBT324X1200NH	WBT324X1200UNH	1200	2400	NXD6	79.75	35.55	16.96

^① Dimensions subject to changes.

^② Non Standard item – extended lead time applies.

Power Mod

Type BFT Main Feed Thru

BFT - Main Feed Thru Modules

The BFT is a main breaker module for the Power Mod group metering line up that has the ability to isolate power to side-mounted modules just like any other Power Mod main breaker module, but also contains feed-through lugs that can be used to supply and isolate power vertically to downstream group metering line ups. This is a revolutionary product in cabled riser applications..

Features include:

- QuickSystem™ features
- Suitable for use as service entrance equipment
- Breaker protects power outgoing, vertically and horizontally
- 1200A meets EUSERC requirements
- Incoming and outgoing Power Mod thru bus
- Standard compression lug capability
- 65K AIC standard, 100K AIC available for all models
- Main breaker with broad ampacity ratings from 1200A to 2000A
- Field installable shunt trip

Main Feed Thru Quick Reference

- 200-1200A main bus rating (breaker)
- 1200-2400A horizontal bus rating (feed thru)
- 1200 thru-bus rating
- UL Standard #67
- UL file #E27100
- AIC rating (65K and 100K)
- Voltage: 240V AC max
- Available in single-phase and three-phase
- All swing latches and rivets are stainless steel
- NEMA Type 1 (indoor)
- G90 galvanized steel
- ANSI 61 paint
- All modules are bottom-feed only
- All modules have no hubs
- EUSERC drawing #347

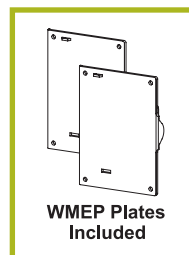
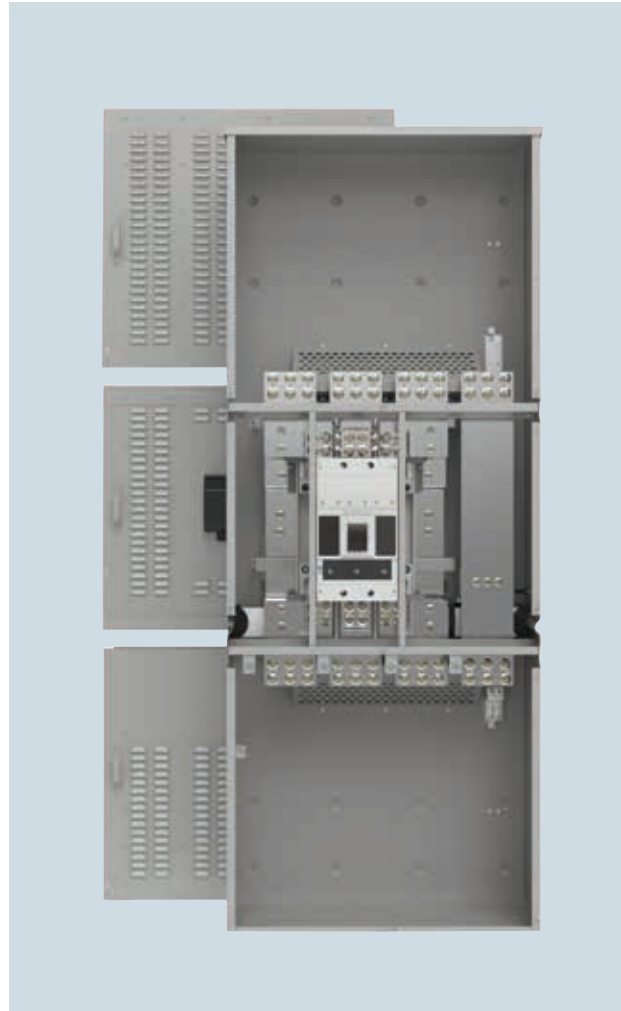

Power Mod

Type BFT Main Feed Thru

Connects via lugs.

Lug kits not included. Lug kits must be ordered separately per module.

Refer to pages 92-93 for lug size options.



Suitable for use as service equipment.
Certain conditions may apply. See wiring diagram for details.

1-Phase, 3 Wire SN, 240V AC Max.

Catalog No. (65k AIC)	Catalog No. (100k AIC) ^②	Breaker Amperage Rating	Breaker Type (65k AIC)	Breaker Type (100k AIC) ^②	Dimensions (inches) ^①		
					Height	Width	Depth
BFT11200B	BFT11200BU	1200	PXD6	HPXD6	89.78	35.53	15.05
BFT11400B	BFT11400BU	1400	PXD6	HPXD6	89.78	35.53	15.05
BFT11600B	BFT11600BU	1600	PXD6	HPXD6	89.78	35.53	15.05
BFT11800B	BFT11800BU	1800	RXD6	HRXD6	89.78	35.53	15.05
BFT12000B	BFT12000BU	2000	RXD6	HRXD6	89.78	35.53	15.05

3-Phase, 4 Wire SN, 240V AC Max.

Catalog No. (65k AIC)	Catalog No. (100k AIC) ^②	Breaker Amperage Rating	Breaker Type (65k AIC)	Breaker Type (100k AIC) ^②	Dimensions (inches) ^①		
					Height	Width	Depth
BFT31200B	BFT31200BU	1200	PXD6	HPXD6	89.78	35.53	15.05
BFT31400B	BFT31400BU	1400	PXD6	HPXD6	89.78	35.53	15.05
BFT31600B	BFT31600BU	1600	PXD6	HPXD6	89.78	35.53	15.05
BFT31800B	BFT31800BU	1800	RXD6	HRXD6	89.78	35.53	15.05
BFT32000B	BFT32000BU	2000	RXD6	HRXD6	89.78	35.53	15.05

^① Dimensions subject to changes.

^② Non Standard item – extended lead time applies.

Power Mod

Type BFT Main Feed Thru

Imagine a four-story building designed with a group metering line up on each floor. If the total load is between 1,200 and 2,000 amps, one BFT module can be placed on the first floor as the main for the first floor's meters and the service entrance main for the entire building using feed-through tapboxes on the second and third floors and a standard breaker main or WBT tapbox on the fourth floor.

Competitor

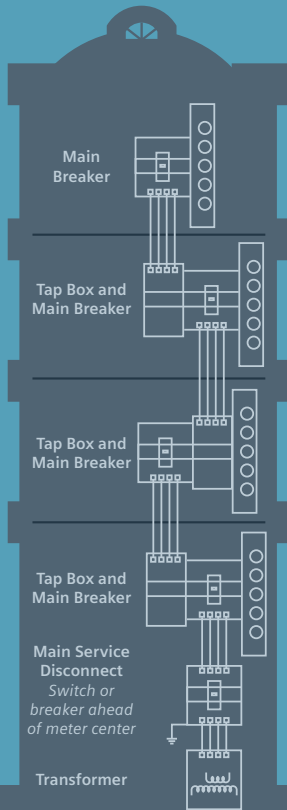

Mid-rise or high-rise multi-family building as configured by Siemens competitor.

WBT

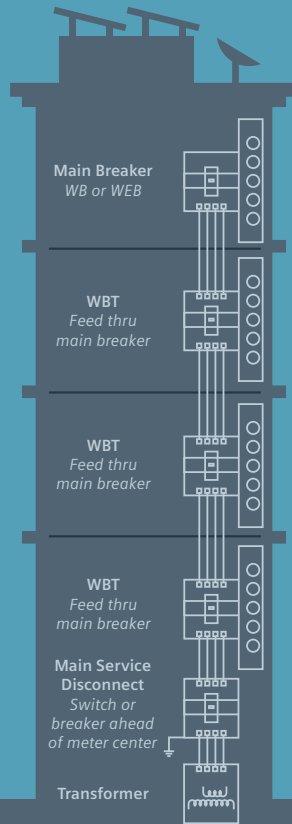

Mid-rise or high-rise multi-family building as configured by Siemens prior to BFT, using the WBT to consolidate enclosures and save material cost and wall space.

BFT & WBT

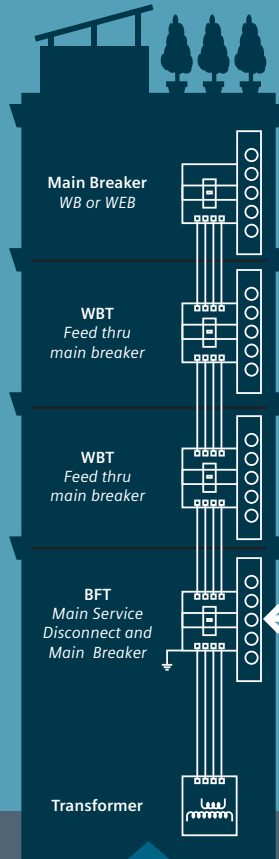

Combined WBT and BFT solution for a mid-rise or high-rise multi-family building.

With the invention of the Power Mod BFT, Siemens can integrate the main service disconnect into the meter center lineup.

BFT & WT

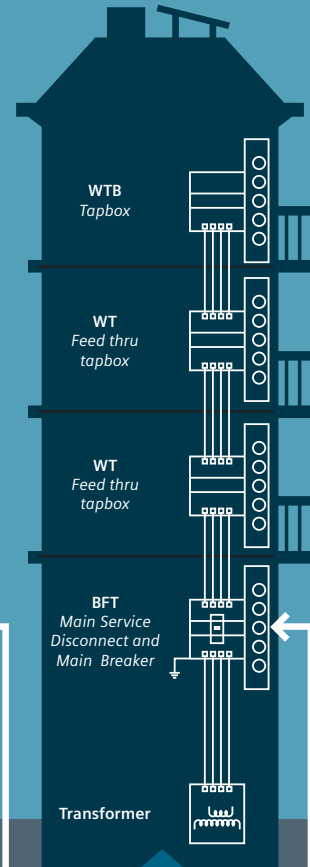

Combined BFT and WT solution for a mid-rise or high-rise multi-family building.

This would be an optimal configuration utilizing Power Mod BFT if individual floor disconnects are not required.



Space savings



Cost savings on total installation



We listened: Meets engineers' demand



One breaker protects entire building



One service disconnect

Power Mod

Type BFT Main Feed Thru

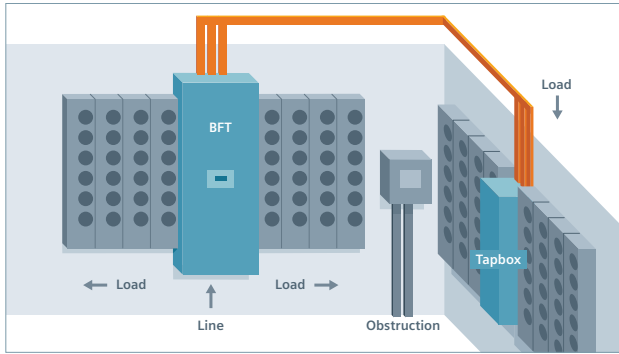

Another way to use the BFT

The BFT can be used to get around an obstruction such as a doorway, fire safety equipment, etc. The Main Feed Thru is grounded for service entrance applications from the factory but the bond can be removed for non-SER applications.

BFT Lug Kits

Lug kits to use with the BFT

		1 Phase	3 Phase	No. Wires/ Phase	Max CU wire size (KCML)	Max AL wire size (KCML)
BFT	Amperages 1200-2000	LK14500N2E	LK34500N2E	4	600	600
		LK15600N2	LK35600N2	5	600	600
		LK13750N2E	LK33750N2E	3	750	800
		LK15750N2	LK35750N2	5	750	750
		LK16750N2	LK36750N2	6	750	750
		LK18500N2CD	LK38500N2CD	8	500	750
		LK18750N2AD	LK38750N2AD	8	500	750

These wire sizes are recommended based on wire size allowed by the lug size as well as wire bending space requirements of the enclosure.

Lug Kit Contents

Wire Range: 1/0-750 kcmil	Wire Range: #2-600 kcmil	Wire Range: 300-800 kcmil	Downward Bus Extension
Wire Binding Screw Torque: 500 lb.-in.	Wire Binding Screw Torque: 500 lb.-in.	Wire Binding Screw Torque: 500 lb.-in.	Wire Binding Screw Torque: 500 lb.-in.

Lug Kit Catalog No.	Wire Range	Lug Qty.	Lug Qty.	Lug Qty.	Lug Qty.
LK14500N2E	1/0-500 kcmil	3	6	-	-
LK34500N2E	1/0-500 kcmil	4	8	-	-
LK15600N2	1/0-500 kcmil	6	3	-	-
LK35600N2	1/0-500 kcmil	8	4	-	-
LK13750N2E	300-750 kcmil	-	-	9	-
LK33750N2E	300-750 kcmil	-	-	12	-
LK15750N2	300-750 kcmil	6	-	3	-
LK35750N2	300-750 kcmil	8	-	4	-
LK16750N2	1/0-750 kcmil	9	-	-	-
LK36750N2	1/0-750 kcmil	12	-	-	-
LK18500N2CD	1/0-500 kcmil CU	12	-	-	3
LK38500N2CD	1/0-500 kcmil CU	16	-	-	4
LK18570N2AD	1/0-500 kcmil AL	12	-	-	3
LK38570N2AD	1/0-500 kcmil AL	16	-	-	4

Power Mod

Type WS Standard Switch Mains

Standard Switch Mains

Standard switch modules (type WS) are designed for flexibility, space savings, and durability.

Features include:

- QuickSystem™ features
- Standard compression lug capability
- Invertibility: 400-800 Amp devices can be rotated to accommodate the desired incoming feed direction
- 750 kcmil AL wire options for most models
- 100K AIC standard for all models
- Class T fuse provisions
- Front mounted handle – removes the need for spacers on the side
- Broad ampacity ratings up to 1200 Amps

Standard Switch Mains quick reference

- 200-1200A
- 1200A thru-bus
- UL Standard # UL98
- UL file #E25506
- AIC rating (100k AIC)
- Voltage:
 - Single phase 120/240V AC max
 - Three phase 240V AC max
- All swing latches and rivets are stainless steel
- NEMA 3R rated
- G90 galvanized steel
- ANSI 61 paint
- Custom options available.

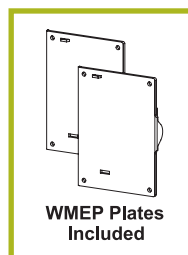

Power Mod



Type WS Standard Switch Mains

Suitable for use as service equipment. Certain conditions may apply. See wiring diagram for details.



Lugs not included on most models.
NEMA II stud pattern lugs must be installed by user or utility.
Refer to pages 92-93 for lug size options.



Fusible switch service entrance modules: 1-phase, 3-wire SN, 120/240V AC^④

Catalog No. (100k AIC)	Catalog No. (100k AIC) Blank Endwall	Rating Amps	Service Feed	Fuse Type ^⑤	Dimensions (inches) ^①			Line Side Connections	Knockout Diagrams
					Height	Width	Depth		
WMP02U ^{②③}	WMP02UNH	200	OH/UG	T	33.00	12.00	13.00	(1) #6 - 250 KCMIL	S-0
WS1400CU ^③	WS1400CUNH	400	OH/UG ^④	T	50.13	15.19	16.31	1 set of 2 studs  (lugs not included)	S-1
WS1600CU ^③	WS1600CUNH	600	OH/UG ^④	T	50.13	15.19	16.31		
WS1800CU ^③	WS1800CUNH	800	OH/UG ^④	T	50.13	15.19	16.31	2 sets of 2 studs  (lugs not included)	S-2
WS11200BU ^{③⑦}	—	1200	UG	T	50.06	20.22	16.06	(4) 250- 500 kcmil	S-3

Fusible switch service entrance modules: 3-phase, 4-wire WN, 240V AC Max.^⑥

Catalog No. (100k AIC)	Catalog No. (100k AIC) Blank Endwall	Rating Amps	Service Feed	Fuse Type ^⑤	Dimensions (inches) ^①			Line Side Connections	Knockout Diagrams
					Height	Width	Depth		
WMP024U ^{②③}	WMP024UNH	200	OH/UG	T	33.00	12.00	13.00	(1) #6 - 250 KCMIL	S-0
WS3400CU ^③	WS3400CUNH	400	OH/UG ^④	T	50.13	15.19	16.31	1 set of 2 studs  (lugs not included)	S-1
WS3600CU ^③	WS3600CUNH	600	OH/UG ^④	T	50.13	15.19	16.31		
WS3800CU ^③	WS3800CUNH	800	OH/UG ^④	T	50.13	15.19	16.31	2 sets of 2 studs  (lugs not included)	S-2
WS31200BU ^{③⑦}	—	1200	UG	T	50.06	20.22	16.06	(4) 250-500 kcmil	S-3

① Dimensions shown are representative of outside box dimensions and do not include allowances for mounting bumps, endwalls, covers, hubs, or hardware protrusions. Dimensions are subject to change.

② Additional lead time required. Contact sales office for details. Fusible pull-out switch.

③ Lugs not included. Refer to pages 92-93 for lug size options. NEMA II stud pattern compression lugs must be installed by user or utility.

④ Module is invertible – rotate device to point hub openings to appropriate feed direction.

⑤ 500 kcmil max wire range size.

⑥ Fuses not included.

⑦ Device uses a molded case switch (looks like a breaker). Class T fuses must be installed in conjunction with the molded case switch for proper operation.

⑧ Depending on installation details and adjacent product, a WSP spacer module may be required to provide enough clearance for hinges/latches. Contact your local sales person for support

Power Mod

Type WES Switch-Pullbox Combinations

Switch-Pullbox Combinations

EUSERC - compliant switch-pullbox combination modules (type WES) offer EUSERC compatibility, a wider range of lug options, and extra space for pulling in conductors.

Features include:

- QuickSystem™ features
- Factory installed NEMA II studs
- Broad ampacity ratings up to 1200 Amps
- 750kcmil AL wire options
- 100K AIC standard for all models
- Removable blank bottom endwall
- Front mounted handle - removes the need for spacers on the side
- Class T fuse provisions
- Large removable ground wire trough with generous space for grounding conductors
- Extra ground lugs in each device

Switch-Pullbox Combinations quick reference

- 400-1200A
- 1200A thru-bus
- UL standard # UL98
- UL file # E25506
- AIC Rating (100k AIC)
- Voltage:
 - Single phase 120/240V AC max
 - Three phase 240V AC max
- All swing latches and rivets are stainless steel.
- NEMA 3R rated
- G90 galvanized steel
- ANSI 61 paint
- EUSERC drawing number 347
- Custom options available.

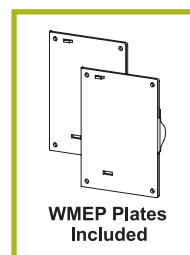

Power Mod



Type WES Switch-Pullbox Combinations

Suitable for use as service equipment. Certain conditions may apply. See wiring diagram for details.



Lugs not included.
NEMA II Stud Pattern lugs must be installed by user or utility.
Refer to pages 92-93 for lug size options.



Combination fusible switch and pullbox modules: 1-phase, 3-wire SN, 120/240V AC Meets EUSERC requirements^③

Catalog No. (100k AIC)	Rating Amps	Service Feed	Fuse Type ^②	Dimensions (inches) ^①			Line Side ^② Connections (lugs not included)	Knockout Diagram
				Height	Width	Depth		
WES1400BU	400	UG	T	54.06	29.19	15.94	1 set of 2 studs 	ES-1
WES1600BU	600	UG	T	54.06	29.19	15.94	2 sets of 2 studs 	ES-2
WES1800BU	800	UG	T	54.06	29.19	15.94		
WES11200BU ^④	1200	UG	T	68.97	34.25	13.47	3 sets of 2 studs 	ES-3

Combination fusible switch and pullbox modules: 3-phase, 4-wire SN, 240V AC max. Meets EUSERC requirements^③

Catalog No. (100k AIC)	Rating Amps	Service Feed	Fuse Type	Dimensions (inches) ^①			Line Side ^② Connections (lugs not included)	Knockout Diagram
				Height	Width	Depth		
WES3400BU	400	UG	T	54.06	29.19	15.94	1 set of 2 studs 	ES-1
WES3600BU	600	UG	T	54.06	29.19	15.94	2 sets of 2 studs 	ES-2
WES3800BU	800	UG	T	54.06	29.19	15.94		
WES31200BU ^④	1200	UG	T	68.97	34.25	13.47	3 sets of 2 studs 	ES-3

^① Dimensions shown are representative of outside box dimensions and do not include allowances for mounting bumps, endwalls, covers, hubs, or hardware protrusions. Dimensions are subject to change.

^② Lugs not included. Refer to pages 92-93 for lug size options. NEMA II stud pattern compression lugs must be installed by user or utility.

^③ Fuses not included.
^④ Device uses a molded case switch (looks like a breaker). Class T fuses must be installed in conjunction with the molded case switch for proper operation.

Power Mod

Type WXS Switch Units

Cross Bus Switch modules

Cross Bus switch modules (type WXS) offer two distinct functions: first they can be used to connect Siemens Sentron Busway to a Power Mod line-up. Second they can be utilized to offer lower service disconnect ampacities or unique configurations where an incoming tap box is preferred.

Features include:

- QuickSystem™ features
- Incoming and outgoing bus connections (right to left or left to right)
- Standardized connection points to Siemens Sentron Busway
- 100K AIC standard for all models
- Externally accessible switch handle with padlock capability
- Class T fuse provisions
- Invertibility: Devices must be installed with line and load side in correct order

Circuit Breaker-Pullbox Combinations Quick Reference

- 400-800A
- 1200A thru-bus rating
- UL Standard # UL98
- UL file # E25506
- AIC rating (100k)
- Voltage:
 - Single phase 120/240V AC max
 - Three phase 240V AC max
- All swing latches and rivets are stainless steel
- NEMA 3R rated
- G90 galvanized steel
- ANSI 61 paint
- Custom options available.

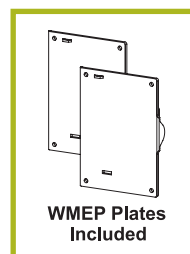

Power Mod

Type WXS Switch Units

Not suitable for use as service equipment.

Connects via thru
bussing only -
NO LUGS



1-phase, 3-wire SN, 120/240V AC^②

Catalog No. (100k AIC)	Ampere Rating	Service Feed	Fuse Type	Dimensions ^①			Knockout Diagram
				Height	Width	Depth	
WXS1400NU	400	Thru Bus	T	35.62	18.16	16.31	WXS
WXS1600NU	600	Thru Bus	T	35.62	18.16	16.31	
WXS1800NU	800	Thru Bus	T	35.62	18.16	16.31	

3-phase, 4-wire SN, 240V AC max^②

Catalog No. (100k AIC) ^③	Ampere Rating	Service Feed	Fuse Type	Dimensions ^①			Knockout Diagram
				Height	Width	Depth	
WXS3400NU	400	Thru Bus	T	35.62	18.16	16.31	WXS
WXS3600NU	600	Thru Bus	T	35.62	18.16	16.31	
WXS3800NU	800	Thru Bus	T	35.62	18.16	16.31	

^① Dimensions shown are representative of outside box dimensions and do not include allowances for mounting bumps, endwalls, covers, hubs, or hardware protrusions. Dimensions are subject to change.

^② Connects via thru bussing only – NO LUGS.

Power Mod

Type WTB Standard Tap boxes

Standard Tap boxes

Standard tap box modules (type WTB) are designed for versatility, space savings, and flexibility.

Features include:

- QuickSystem™ features
- Standard compression lug capability
- Invertibility: some devices can be rotated to accommodate the desired incoming feed direction (1600 Amps and lower)
- 750 kcmil AL wire options for most models
- 100K AIC standard for all models
- Broad ampacity ratings from 400 to 2400 Amps
- Line and load capability- service entrance and sub feed rated

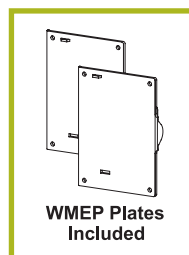

Restrictions for 1600-2400amp type WTB Power Mod Tap Boxes:

When the 1600, 2000, or 2400A tap boxes are used as service entrance equipment (fed directly from utility transformer) or when the supply originates from a Class L fuse or Siemens WL circuit breaker there are restrictions on the use of an additional down-stream (thru-bus connected) WTB, WTB, WET, or WT type Power Mod tap boxes. In these instances a type "WXB" module must be used as protection for the downstream tap box. box (placed between the incoming WTB tap box and the downstream outgoing tap box). This restriction does **NOT** apply if the tap box is fed from a Siemens Sentron or VL series molded case circuit breaker. Note that the maximum amperage for a Siemens Sentron circuit breaker is 2,000A.

Power Mod

Type WTB Standard Tap boxes

⚠️ Restrictions for 1600-2400amp type WTB Power Mod Tap Boxes: ⚠️

When the 1600, 2000, or 2400amp tap boxes are used as service entrance equipment (fed directly from utility transformer) or when the supply originates from a Class L fuse or Siemens WL circuit breaker there are restrictions on the use of an additional down-stream (thru-bus connected) WTB, WTB, WET, or WT type Power Mod tap boxes. In these instances a type "WXB" module must be used as protection for the downstream tap box. box (placed between the incoming WTB tap box and the downstream outgoing tap box). This restriction does NOT apply if the tap box is fed from a Siemens Sentron or VL series molded case circuit breaker. Note that the maximum amperage for a Siemens Sentron circuit breaker is 2,000A.







Suitable for use as service equipment.
Certain conditions may apply. See wiring diagram for details.

Lugs not included.
NEMA II Stud
Pattern lugs must be
installed by user or
utility.







Refer to pages
92-93 for lug size
options.



Tap box modules: 1-phase, 3-wire WN, 120/240V AC^⑤

Catalog No. (100k AIC)	Catalog No. (100k AIC) Blank Endwall	Ampere Rating ^③	Service Feed	Dimensions (inches) ^①			Line Side Connections ^② (lugs not included)	KO Diagram
				Height	Width	Depth		
WTB1400CU	WTB1400CUNH	400	OH/UG ^④	40.13	12.22	13.19	1 set of 2 studs 	T-1
WTB1800CU	WTB1800CUNH	800	OH/UG ^④	40.13	12.22	13.19	2 sets of 2 studs 	T-2
WTB11200CU	WTB11200CUNH	1200	OH/UG ^④	47.13	15.61	13.31		T-3
WTB11600CU ^⑥	WTB11600CUNH ^⑥	1600	OH/UG ^④	50.25	25.09	13.81	3 sets of 2 studs 	T-4
WTB12000TU ^⑥	WTB12000TUNH ^⑥	2000	OH	67.94	35.00	14.78	3 sets of 2 studs 	T-6
WTB12000BU ^⑥	—		UG					
WTB12400TU ^⑥	WTB12400TUNH ^⑥	2400	OH	67.94	35.00	14.78	3 sets of 2 studs 	
WTB12400BU ^⑥	—		UG				Optional 4 sets of 2 studs ^{⑦⑧} 	

Tap box modules: 3-phase, 4-wire SN, 240V AC Max.^⑤

Catalog No. (100k AIC)	Catalog No. (100k AIC) Blank Endwall	Ampere Rating ^③	Service Feed	Dimensions (inches) ^①			Line Side Connections ^② (lugs not included)	KO Diagram
				Height	Width	Depth		
WTB3400CU	WTB3400CUNH	400	OH/UG ^④	40.13	12.22	13.19	1 set of 2 studs 	T-1
WTB3800CU	WTB3800CUNH	800	OH/UG ^④	40.13	12.22	13.19	2 sets of 2 studs 	T-2
WTB31200CU	WTB31200CUNH	1200	OH/UG ^④	60.31	15.61	17.75		T-3
WTB31600CU ^⑥	WTB31600CUNH ^⑥	1600	OH/UG ^④	50.25	25.09	13.81	3 sets of 2 studs 	T-5
WTB32000TU ^⑥	WTB32000TUNH ^⑥	2000	OH	67.94	35.00	14.78	3 sets of 2 studs 	T-6
WTB32000BU ^⑥	—		UG					
WTB32400TU ^⑥	WTB32400TUNH ^⑥	2400	OH	67.94	35.00	14.78	3 sets of 2 studs 	
WTB32400BU ^⑥	—		UG				Optional 4 sets of 2 studs ^{⑦⑧} 	

① Dimensions shown are representative of outside box dimensions and do not include allowances for mounting bumps, endwalls, covers, hubs, or hardware protrusions. Dimensions are subject to change.

② Lugs not included. Refer to pages 92-93 for lug size options. 750 conductor size available NEMA II stud

pattern compression lugs must be installed by user or utility.

③ 1200 amp maximum feed per side, any unit over 1200A must be used as a center fed main.

④ Module is invertible- rotate device to point hub openings to appropriate feed direction.

⑤ QuickConnect not included. If used for load side application an additional coupler must be ordered.

⑥ Please see restriction note above.

⑦ Please see lug kit number LK18500N2C on pages 92-93. For use with 500kcmil ONLY.

⑧ Fits 2400amp models ONLY.

Power Mod

Type WET Tap box - Pullbox Combinations

Tap box – Pullbox Combinations

EUSERC – compliant Tap box – Pullbox Combination modules (type WET) offer EUSERC compatibility, a wider range of lug options, and extra space for pulling in conductors.

Features include:

- QuickSystem™ features
- Standard compression lug capability
- 750 kcmil AL wire options for most models
- 100K AIC standard for all models
- Broad ampacity ratings from 400 to 1200 Amps
- Removable bottom endwall

Tap box – Pullbox Combination quick reference

- 400-1200A
- 1200 Amp thru-bus rating
- UL Standard #'s UL67
- UL file # E27100
- AIC Rating (100k)
- Voltage
 - Single phase 120/240V AC max
 - Three phase 240V AC max
- All swing latches and rivets are stainless steel.
- NEMA 3R rated
- G90 galvanized steel
- ANSI 61 paint
- EUSERC drawing numbers 343 and 347
- Custom options available.

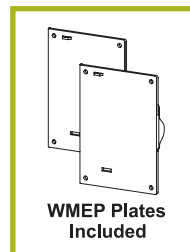

Power Mod



Type WET Tap box - Pullbox Combinations

Suitable for use as service equipment. Certain conditions may apply. See wiring diagram for details.



Lugs not included.
NEMA II Stud Pattern lugs must be installed by user or utility.
Refer to pages 92-93 for lug size options.



EUSERC tap box modules: 1-phase, 3-wire SN, incoming, 120/240V AC Meets EUSERC requirements

Catalog No. (100k AIC)	Ampere Rating	Service Feed ^②	Dimensions (inches) ^①			Line Side Connections ^② (lugs not included)	Knockout Diagram
			Height	Width	Depth		
WET1400BU	400	UG	46.19	17.63	8.56	1 set of 2 studs 	ET-1
WET1800BU	800	UG	50.19	27.13	11.38	2 sets of 2 studs 	ET-2
WET11200BU	1200	UG	50.19	35.19	11.38	3 sets of 2 studs 	ET-3

EUSERC tap box modules: 3-phase, 4-wire SN, incoming, 240V AC max. Meets EUSERC requirements

Catalog No. (100k AIC)	Ampere Rating	Service Feed	Dimensions (inches) ^①			Line Side Connections ^② (lugs not included)	Knockout Diagram
			Height	Width	Depth		
WET3400BU	400	UG	46.19	17.63	8.56	1 set of 2 studs 	ET-1
WET3800BU	800	UG	50.19	27.13	11.38	2 sets of 2 studs 	ET-2
WET31200BU	1200	UG	50.19	35.19	11.38	3 sets of 2 studs 	ET-3

^① Dimensions shown are representative of outside box dimensions and do not include allowances for mounting bumps, endwalls, covers, hubs, or hardware protrusions. Dimensions are subject to change.

^② Lugs not included. Refer to pages 92-93 for lug size options. NEMA II stud pattern compression lugs must be installed by user or utility.

Power Mod

Type WT Feed Thru Tap box

Feed Thru Tap box

Family (type WT), the Feed Thru Tap box features cable in cable out lugs. Valuable for use in mid rise and high rise projects.

Features include:

- QuickSystem features
- Standard compression lug capability
- 250kcmil Al wire options
- 100k AIC standard
- Removable bottom endwell

Feed Thru Tap box quick reference

- 400 - 2400A
- 1200A thru bus
- UL standard 67
- UL file no. E27100
- AIC rating (100k AIC)
- Voltage:
 - Single phase 120/240V AC max.
 - Three phase, 240V AC max
- All swing latches and rivets are stainless steel.
- NEMA 3R rated
- G90 galvanized steel
- ANSI 61 paint
- Custom options available.
- Broad ampacity ratings from 400 to 2400 Amps

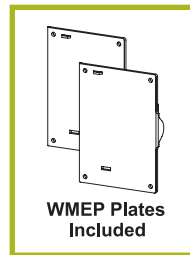

Restrictions for 1600-2400amp type WT Power Mod Pull-Thru Tap Boxes:

When the 1600, 2000, or 2400amp tap boxes are used as service entrance equipment (fed directly from utility transformer) or when the supply originates from a Class L fuse there are restrictions on the use of an additional down-stream (thru-bus connected) WTBN, WTB, WET, or WT type Power Mod tap boxes. In these instances a type "WXB" module must be used as protection for the downstream tap box (placed between the incoming WT tap box and the downstream outgoing tap box). See page 2-70 for an example. This restriction does **NOT** apply if the tap box is fed from a Siemens Sentron or VL series molded case circuit breaker. Note that the maximum amperage for a Siemens Sentron circuit breaker is 2,000A. Please note that Siemens type WL circuit breakers can NOT be used to feed WT Power Mod tap boxes.

Power Mod

Type WT Feed Thru Tap box



Restrictions for 1600-2400amp type WT Power Mod Pull-Thru Tap Boxes:



When the 1600, 2000, or 2400amp tap boxes are used as service entrance equipment (fed directly from utility transformer) or when the supply originates from a Class L fuse there are restrictions on the use of an additional down-stream (thru-bus connected) WTBN, WTB, WET, or WT type Power Mod tap boxes. In these instances a type "WXB" module must be used as protection for the downstream tap box (placed between the incoming WT tap box and the downstream outgoing tap box). See page 2-70 for an example. This restriction does **NOT** apply if the tap box is fed from a Siemens Sentron or VL series molded case circuit breaker. Note that the maximum amperage for a Siemens Sentron circuit breaker is 2,000A. Please note that Siemens type WL circuit breakers can NOT be used to feed WT Power Mod tap boxes.

Lug kits not included.

(2) Lug kits must be ordered separately per module.

Refer to pages 92-93 for lug size options.



Not suitable for use as service equipment.

Feed Thru Tap box modules: 1-phase, 120/240V AC

Catalog No. (100k AIC)	Catalog No. (100k AIC) Blank Endwall	Ampere Rating	Service Feed	Dimensions (inches) ^①			Line Side Connections ^②	KO Diagram
				Height	Width	Depth		
WT1400PU	WT1400PUNH	400	OH/UG	59.25	17.25	8.13	1 set of 2 studs	
WT1800PU	WT1800PUNH	800		62.25	26.75	11.13	2 sets of 2 studs	
WT11200PU	WT11200PUNH	1200		68.34	35.19	11.41	3 sets of 2 studs	WP-1
WT11600PU ^③	WT11600PUNH ^③	1600		67.94	35	14.78		
WT12000PU ^③	WT12000PUNH ^③	2000		67.94	35	14.78		3 sets of 2 studs Optional 4 sets of 2 studs ^④
WT12400PU ^③	WT12400PUNH ^③	2400						

Feed Thru Tap box modules: 3-phase, 240V AC

Catalog No. 100k AIC)	Catalog No. (100k AIC) Blank Endwall	Ampere Rating	Service Feed	Dimensions (inches) ^①			Line Side Connections ^②	KO Diagram
				Height	Width	Depth		
WT3400PU	WT3400PUNH	400	OH/UG	59.25	17.25	8.13	1 set of 2 studs	
WT3800PU	WT3800PUNH	800		62.25	26.75	11.13	2 sets of 2 studs	
WT31200PU	WT31200PUNH	1200		68.34	35.19	11.41	3 sets of 2 studs	WP-1
WT31600PU ^③	WT31600PUNH ^③	1600		67.94	35	14.78		
WT32000PU ^③	WT32000PUNH ^③	2000		67.94	35	14.78		3 sets of 2 studs Optional 4 sets of 2 studs ^④
WT32400PU ^③	WT32400PUNH ^③	2400						

① Dimensions shown are representative of outside box dimensions and do not include allowances for mounting bumps, endwalls, covers, hubs, or hardware protrusions. Dimensions are subject to change.

② Lugs not included. Refer to pages 92-93 for lug size options. (2) Lug kits must be ordered separately per module.

③ 1200 amp maximum feed per side-must be used as a center fed main.

④ Please see restriction note above.

⑤ Optional four sets of two studs obtained by installing bus extension which is provided in all applicable lug kits.

Power Mod

Type WMM Residential Meter Stacks

Residential Meter Stacks

Power Mod's core offering of Residential Meter Stacks, type WMM, offers the widest product offering and flexibility in the industry. Each meter stack houses the QuickSystem™ features to maximize productivity and minimize labor costs. To aid in productivity and labor cost reductions our 225 Amp meter stacks feature a new breaker - the "QS". The QS breaker adds to the Siemens exclusive feature set on our new 225 Amp Residential Meter Stacks.

Benefits of the "QS" include:

- An exclusive 6 high 225 Amp meter stack at the same height as our 125 Amp meter stack - 225 to 125 conversion: No conversion kit needed.
- Single right hand bend wiring - saves time and wire
- 100K AIC offered from 100 up to 225 Amps

Siemens Residential Meter Stacks are packed with features inside and out: our exclusive knock out plate offers flexibility when pulling wires to the stack, new breaker supports keep breakers level and straight, moveable neutrals and grounds to save wire, and all of the QuickSystem features all designed with the contractor in mind.

Residential Meter Stacks quick reference

- 2-6 gang
- 125/225 Amp per position
- 1200 Amp thru-bus rating
- UL standard 67
- UL file no. E27100
- AIC rating (65k and 100k)
- Voltage:
 - Single phase 120/240V AC max.
 - Three phase in single phase out
 - 120/208V AC max.
 - 240/120V AC max.
- All swing latches and rivets are stainless steel.
- Outdoor= NEMA 3R rated
- Indoor= NEMA 1R rated
- G90 galvanized steel
- ANSI 61 paint
- Custom options available.

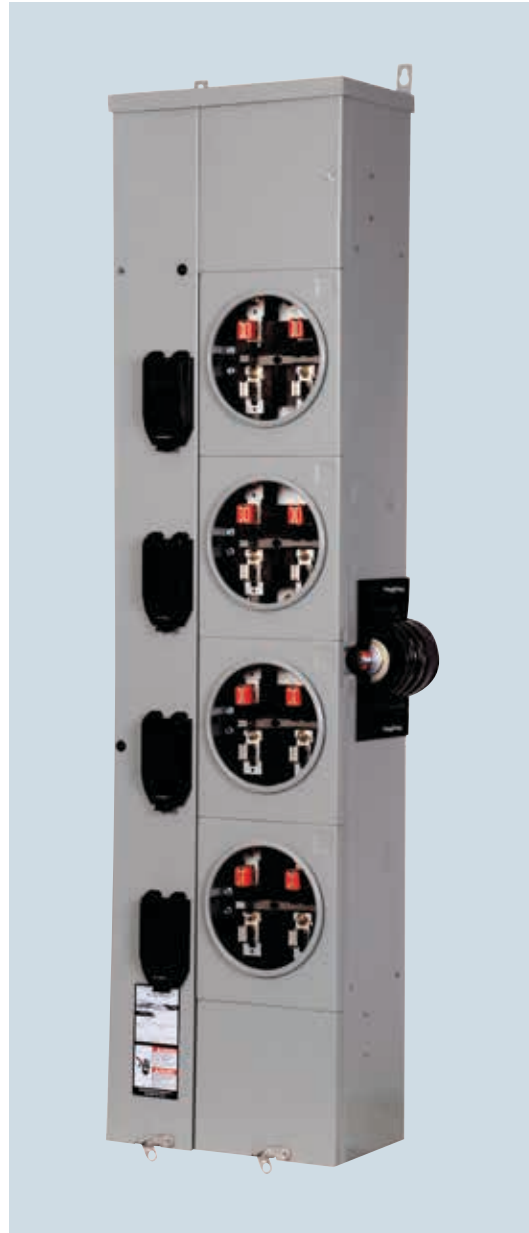

Power Mod

Type WMM Residential Meter Stacks – 1 phase 4J

- 2-6 gang
- 125/225 Amp per position
- 1200 Amp thru-bus rating



Residential 4-jaw ring type meter stacks: 1-phase, 3-wire SN, incoming and outgoing^{③ ④}

Outdoor Catalog No.	Indoor Catalog No.	Meter Positions Per Stack	Breaker Provision	Maximum AIC ^⑤	Dimensions (inches) ^①			Knockout Diagram
					Height	Width	Depth	
Max. tenant breaker (Amps): 125								
WMM21125	MM21125	2 Position	QP, QPH, HQP, MP-T, MP-HT, MP-MT	65k	34.31	13.09	8.09	KA-12
WMM31125	MM31125	3 Position		65k	43.31	13.09	8.09	KA-13
WMM41125	MM41125	4 Position		65k	52.31	13.09	8.09	KA-14
WMM51125	MM51125	5 Position		65k	61.31	13.09	8.09	KA-15
WMM61125	MM61125	6 Position		65k	70.31	13.09	8.09	KA-16
Max. tenant breaker (Amps): 225^{②③}								
WMM21225	MM21225	2 Position	QS, QSH, QSHH, HQS, HQSH, QP, QPH, HQP, MP-T, MP-HT, MP-MT	100k	34.31	16.22	8.09	KA-22
WMM31225	MM31225	3 Position		100k	43.31	16.22	8.09	KA-23
WMM41225	MM41225	4 Position		100k	52.31	16.22	8.09	KA-24
WMM51225	MM51225	5 Position		100k	61.31	16.22	8.09	KA-25
WMM61225	MM61225	6 Position		100k	70.31	16.22	8.09	KA-26

Residential 4-jaw ringless type meter stacks: 1-phase, 3-wire SN, incoming and outgoing^{③ ④}

Outdoor Catalog No. (no bypass)	Outdoor Catalog No. (horn bypass)	Indoor Catalog No. (no bypass)	Indoor Catalog No. (horn bypass)	Meter Positions Per Stack	Breaker Provision	Max. AIC ^⑤	Dimensions (inches) ^①			Knockout Diagram
							Height	Width	Depth	
Max. tenant breaker (Amps): 125										
WMM21125R	WMM21125RB	MM21125R	MM21125RB	2 Position	QP, QPH, HQP, MP-T, MP-HT, MP-MT	65k	34.31	13.09	8.09	KA-12
WMM31125R	WMM31125RB	MM31125R	MM31125RB	3 Position		65k	43.31	13.09	8.09	KA-13
WMM41125R	WMM41125RB	MM41125R	MM41125RB	4 Position		65k	52.31	13.09	8.09	KA-14
WMM51125R	WMM51125RB	MM51125R	MM51125RB	5 Position		65k	61.31	13.09	8.09	KA-15
WMM61125R	WMM61125RB	MM61125R	MM61125RB	6 Position		65k	70.31	13.09	8.09	KA-16
Max. tenant breaker (Amps): 225^{②③}										
WMM21225R	WMM21225RB	MM21225R	MM21225RB	2 Position	QS, QSH, QSHH, HQS, HQSH, QP, QPH, HQP, MP-T, MP-HT, MP-MT	100k	34.31	16.22	8.09	KA-22
WMM31225R	WMM31225RB	MM31225R	MM31225RB	3 Position		100k	43.31	16.22	8.09	KA-23
WMM41225R	WMM41225RB	MM41225R	MM41225RB	4 Position		100k	52.31	16.22	8.09	KA-24
WMM51225R	WMM51225RB	MM51225R	MM51225RB	5 Position		100k	61.31	16.22	8.09	KA-25
WMM61225R	WMM61225RB	MM61225R	MM61225RB	6 Position		100k	70.31	16.22	8.09	KA-26

① Dimensions shown are representative of outside box dimensions and do not include allowances for mounting bumps, endwalls, covers, hubs, or hardware protrusions. Dimensions are subject to change.

② 225A available in lower three positions only. 200A continuous for all other positions.

③ NOT for use on 3-phase, 4-wire delta systems.

④ Field installable fifth jaw (ECMF5). Fifth jaw can be isolated if needed (ECMF5I).

⑤ Max AIC determined by maximum AIC of tenant breakers. Higher ratings may be achieved through approved series rating combinations.

⑥ Install QP breakers below QS breakers.

Power Mod

Type WMM Residential Meter Stacks – 1 phase 5J

- 2-6 gang
- 125/225 Amp per position
- 1200 Amp thru-bus rating



Residential 5-jaw ring type meter stacks: 1-phase, 3-wire SN, incoming and outgoing^{③④}

Outdoor Catalog No.	Indoor Catalog No.	Meter Positions Per Stack	Breaker Provision	Maximum AIC ^⑤	Dimensions (inches) ^①			Knockout Diagram
					Height	Width	Depth	
Max. tenant breaker (Amps): 125								
WMM21125J	MM21125J	2 Position	QP, QPH, HQP, MP-T, MP-HT, MP-MT	65k	34.31	13.09	8.09	KA-12
WMM31125J	MM31125J	3 Position		65k	43.31	13.09	8.09	KA-13
WMM41125J	MM41125J	4 Position		65k	52.31	13.09	8.09	KA-14
WMM51125J	MM51125J	5 Position		65k	61.31	13.09	8.09	KA-15
WMM61125J	MM61125J	6 Position		65k	70.31	13.09	8.09	KA-16
Max. tenant breaker (Amps): 225^{②⑥}								
WMM21225J	MM21225J	2 Position	QS, QSH, QSHH, HQS, HQSH, QP, QPH, HQP, MP-T, MP-HT, MP-MT	100k	34.31	16.22	8.09	KA-22
WMM31225J	MM31225J	3 Position		100k	43.31	16.22	8.09	KA-23
WMM41225J	MM41225J	4 Position		100k	52.31	16.22	8.09	KA-24
WMM51225J	MM51225J	5 Position		100k	61.31	16.22	8.09	KA-25
WMM61225J	MM61225J	6 Position		100k	70.31	16.22	8.09	KA-26

Residential 5-jaw ringless type meter stacks: 1-phase, 3-wire SN, incoming and outgoing^{③④}

Outdoor Catalog No. (no bypass)	Outdoor Catalog No. (horn bypass)	Indoor Catalog No. (no bypass)	Indoor Catalog No. (horn bypass)	Meter Positions Per Stack	Breaker Provision	Max. AIC ^⑤	Dimensions (inches) ^①			Knockout Diagram
							Height	Width	Depth	
Max. tenant breaker (Amps): 125										
WMM21125RJ	WMM21125RJB	MM21125RJ	MM21125RJB	2 Position	QP, QPH, HQP, MP-T, MP-HT, MP-MT	65k	34.31	13.09	8.09	KA-12
WMM31125RJ	WMM31125RJB	MM31125RJ	MM31125RJB	3 Position		65k	43.31	13.09	8.09	KA-13
WMM41125RJ	WMM41125RJB	MM41125RJ	MM41125RJB	4 Position		65k	52.31	13.09	8.09	KA-14
WMM51125RJ	WMM51125RJB	MM51125RJ	MM51125RJB	5 Position		65k	61.31	13.09	8.09	KA-15
WMM61125RJ	WMM61125RJB	MM61125RJ	MM61125RJB	6 Position		65k	70.31	13.09	8.09	KA-16
Max. tenant breaker (Amps): 225^{②⑥}										
WMM21225RJ	WMM21225RJB	MM21225RJ	MM21225RJB	2 Position	QS, QSH, QSHH, HQS, HQSH, QP, QPH, HQP, MP-T, MP-HT, MP-MT	100k	34.31	16.22	8.09	KA-22
WMM31225RJ	WMM31225RJB	MM31225RJ	MM31225RJB	3 Position		100k	43.31	16.22	8.09	KA-23
WMM41225RJ	WMM41225RJB	MM41225RJ	MM41225RJB	4 Position		100k	52.31	16.22	8.09	KA-24
WMM51225RJ	WMM51225RJB	MM51225RJ	MM51225RJB	5 Position		100k	61.31	16.22	8.09	KA-25
WMM61225RJ	WMM61225RJB	MM61225RJ	MM61225RJB	6 Position		100k	70.31	16.22	8.09	KA-26

① Dimensions shown are representative of outside box dimensions and do not include allowances for mounting bumps, endwalls, covers, hubs, or hardware protrusions. Dimensions are subject to change.

② 225A available in lower three positions only. 200A continuous for all other positions.

③ NOT for use on 3-phase, 4-wire delta systems.

④ Field installable fifth jaw (ECMF5). Fifth jaw can be isolated if needed (ECMF5i).

⑤ Max AIC determined by maximum AIC of tenant breakers. Higher ratings may be achieved through approved series rating combinations.

⑥ Install QP breakers below QS breakers.

Power Mod

Type WMM Residential Meter Stacks – 3 phase in 1 phase out 5J

- 2-6 gang
- 125/225 Amp per position
- 1200 Amp thru-bus rating



Residential 5-jaw ring type meter stacks: 3-phase, 4-wire SN, incoming and 1-phase, 3 wire SN outgoing^{③④⑦}

Outdoor Catalog No.	Indoor Catalog No.	Meter Positions Per Stack	Breaker Provision	Maximum AIC ^⑤	Dimensions (inches) ^①			Knockout Diagram
					Height	Width	Depth	
Max. tenant breaker (Amps): 125								
WMM22125J	MM22125J	2 Position	QP, QPH, HQP, MP-T, MP-HT, MP-MT	65k	34.31	13.09	8.09	KA-12
WMM32125J	MM32125J	3 Position		65k	43.31	13.09	8.09	KA-13
WMM42125J	MM42125J	4 Position		65k	52.31	13.09	8.09	KA-14
WMM52125J	MM52125J	5 Position		65k	61.31	13.09	8.09	KA-15
WMM62125J	MM62125J	6 Position		65k	70.31	13.09	8.09	KA-16
Max. tenant breaker (Amps): 225^{②⑥}								
WMM22225J	MM22225J	2 Position	QS, QSH, QSHH, HQS, HQSH, QP,QPH, HQP, MP-T, MP-HT, MP-MT	100k	34.31	16.22	8.09	KA-22
WMM32225J	MM32225J	3 Position		100k	43.31	16.22	8.09	KA-23
WMM42225J	MM42225J	4 Position		100k	52.31	16.22	8.09	KA-24
WMM52225J	MM52225J	5 Position		100k	61.31	16.22	8.09	KA-25
WMM62225J	MM62225J	6 Position		100k	70.31	16.22	8.09	KA-26

Residential 5-jaw ringless type meter stacks: 3-phase, 4-wire SN, incoming and 1-phase, 3 wire SN outgoing^{③④⑦}

Outdoor Catalog No. (no bypass)	Outdoor Catalog No. (horn Bypass)	Indoor Catalog No. (no bypass)	Indoor Catalog No. (horn bypass)	Meter Positions Per Stack	Breaker Provision	Max. AIC ^⑤	Dimensions (inches) ^①			Knockout Diagram
							Height	Width	Depth	
Max. tenant breaker (Amps): 125										
WMM22125RJ	WMM22125RJB	MM22125RJ	MM22125RJB	2 Position	QP, QPH, HQP, MP-T, MP-HT, MP-MT	65k	34.31	13.09	8.09	KA-12
WMM32125RJ	WMM32125RJB	MM32125RJ	MM32125RJB	3 Position		65k	43.31	13.09	8.09	KA-13
WMM42125RJ	WMM42125RJB	MM42125RJ	MM42125RJB	4 Position		65k	52.31	13.09	8.09	KA-14
WMM52125RJ	WMM52125RJB	MM52125RJ	MM52125RJB	5 Position		65k	61.31	13.09	8.09	KA-15
WMM62125RJ	WMM62125RJB	MM62125RJ	MM62125RJB	6 Position		65k	70.31	13.09	8.09	KA-16
Max. tenant breaker (Amps): 225^{②⑥}										
WMM22225RJ	WMM22225RJB	MM22225RJ	MM22225RJB	2 Position	QS, QSH, QSHH, HQS, HQSH, QP, QPH, HQP, MP-T, MP-HT, MP-MT	100k	34.31	16.22	8.09	KA-22
WMM32225RJ	WMM32225RJB	MM32225RJ	MM32225RJB	3 Position		100k	43.31	16.22	8.09	KA-23
WMM42225RJ	WMM42225RJB	MM42225RJ	MM42225RJB	4 Position		100k	52.31	16.22	8.09	KA-24
WMM52225RJ	WMM52225RJB	MM52225RJ	MM52225RJB	5 Position		100k	61.31	16.22	8.09	KA-25
WMM62225RJ	WMM62225RJB	MM62225RJ	MM62225RJB	6 Position		100k	70.31	16.22	8.09	KA-26

① Dimensions shown are representative of outside box dimensions and do not include allowances for mounting bumps, endwalls, covers, hubs, or hardware protrusions. Dimensions are subject to change.
 ② 225A available in lower three positions only. 200A continuous for all other positions.

③ Approved for use on 3-phase, 4-wire delta systems. Must field phase away from B phase (A and C phase only).
 ④ 5th jaw can be isolated if needed (ECMF5i).

⑤ Max AIC determined by maximum AIC of tenant breakers. Higher ratings may be achieved through approved series rating combinations.
 ⑥ Install QP breakers below QS breakers.
 ⑦ Stacks come factory phased as AB, BC, AC... top to bottom

Power Mod

Type WML Lever Bypass Meter Stacks

Lever Bypass Meter Stacks

Lever Bypass meter stacks (type WML) are designed to meet the requirements of those utilities specifying lever bypass meter sockets for residential and commercial applications.

Features include:

- QuickSystem™ features[Ⓞ]
- High-quality, time-proven Talon HQ sockets
- A line of 3-phase 100 Amp meter stacks to minimize tenant main cost
- Removable back knockout plate to facilitate wiring
- 225 Amp capability in single and three phase designs
- Up to 4 positions with 225 Amp tenant mains, up to 2 positions with 400 Amp tenant mains
- All lever bypass stacks are ringless.

Lever Bypass quick reference

- 125A 2-6 position
- 100A/225A 1-4 position
- 400A 1-2 position
- 1200A thru-bus rating
- UL Standard # UL67
- UL file # E27100
- AIC rating (25K, 35K, 65K and 100K)
- Voltage
 - Single phase 120/240V AC max
 - Three in single phase out 208Y/120V AC
 - Three Phase 240V AC max
- All swing latches and rivets are stainless steel.
- Indoor = NEMA 1 rated
- Outdoor = NEMA 3R rated
- G90 galvanized steel
- ANSI 61 paint
- Custom options available.

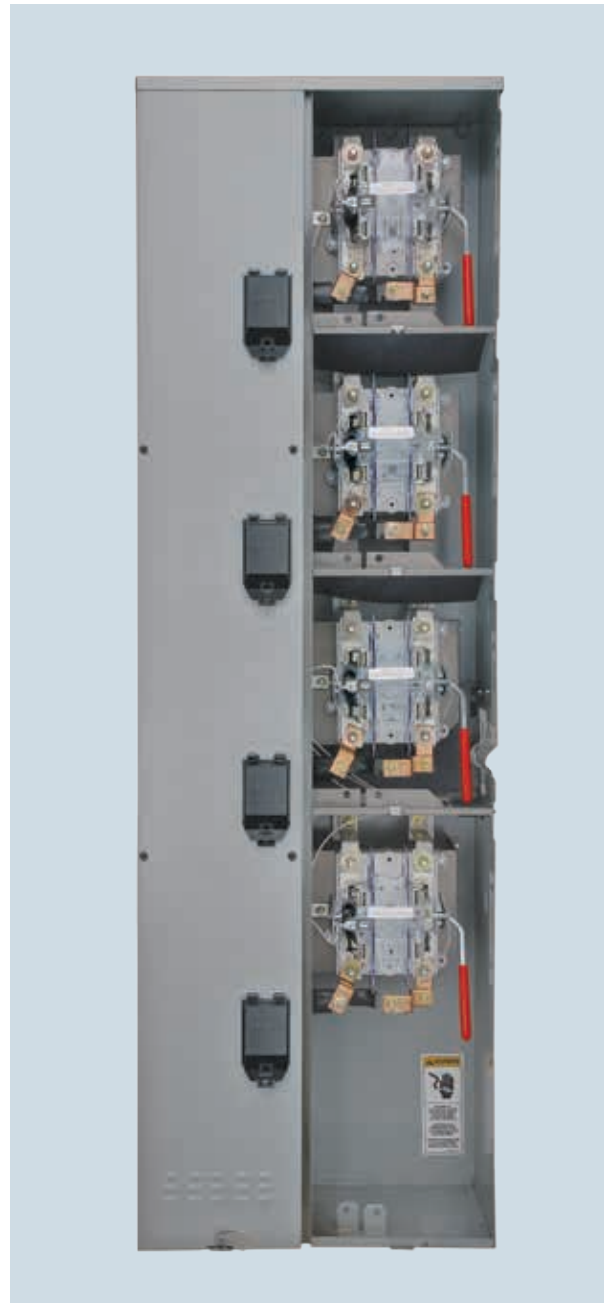

QuickConnect™
Included

[Ⓞ] QuickPhase™ is not applicable with non-field phaseable stacks (WML, 225A-400A, 3-phase-in/3-phase-out).

Power Mod

Type WML Lever Bypass Meter Stacks

- 125A 2-6 position
- 1200A thru-bus rating



Commercial Ringless Type Meter Stacks: Lever Bypass

Outdoor Catalog No.	Indoor Catalog No.	Meter Positions Per Stack	Breaker Provisions	Maximum AIC ^③	Dimensions (inches) ^①			Stack Phasing Phases/sockets
					Height	Width	Depth	

1-Phase, 3-Wire SN, Incoming and Outgoing, Lever Bypass, 5-Jaw Sockets^{②④}

Max. tenant breaker (Amps): 125								
WML21125RJ	ML21125RJ	2	QP, QPH, HQP, MP-T, MP-HT, MP-MT	65k	36.18	14.48	11.51	—
WML31125RJ	ML31125RJ	3		65k	46.18	14.48	11.51	—
WML41125RJ	ML41125RJ	4		65k	56.18	14.48	11.51	—
WML51125RJ	ML51125RJ	5		65k	66.18	14.48	11.51	—
WML61125RJ	ML61125RJ	6		65k	76.18	14.48	11.51	—

3-Phase, 4-Wire SN, Incoming and 1-Phase, 3-Wire SN Outgoing, Lever Bypass, 5-Jaw Sockets^{②④}

Max. tenant breaker (Amps): 125								
WML22125RJ	ML22125RJ	2	QP, QPH, HQP, MP-T, MP-HT, MP-MT	65k	36.18	14.48	11.51	—
WML32125RJ	ML32125RJ	3		65k	46.18	14.48	11.51	—
WML42125RJ	ML42125RJ	4		65k	56.18	14.48	11.51	—
WML52125RJ	ML52125RJ	5		65k	66.18	14.48	11.51	—
WML62125RJ	ML62125RJ	6		65k	76.18	14.48	11.51	—

① Dimensions shown are representative of outside box dimensions and do not include allowances for mounting bumps, hubs, or hardware protrusions.
 ② Not for use on 3-phase, 4-wire delta systems.

③ Max AIC determined by maximum AIC of tenant breakers when used in conjunction with a meter socket. Higher overall ratings may be achieved through approved series rating combinations.
 ④ Stacks are field phaseable.

Power Mod

Type WML Lever Bypass Meter Stacks

- 225A 1-4 position
- 1200A thru-bus rating



Commercial Ringless Type Meter Stacks: Lever Bypass

Outdoor Catalog No.	Indoor Catalog No.	Meter Positions Per Stack	Breaker Provisions	Maximum AIC ^③	Dimensions (inches) ^①			Stack phasing phases/sockets
					Height	Width	Depth	

1-Phase, 3-Wire SN, Incoming and Outgoing, Lever Bypass, 5-Jaw Sockets^{②④}

Max. tenant breaker (Amps): 225								
WML11225RJ	ML11225RJ	1	QS, QSH, QSHH, HQS, HQSH, QP, QPH, HQP, MP-T, MP-HT, MP-MT	100k	27.75	19.50	9.00	—
WML21225RJ	ML21225RJ	2		100k	40.75	19.50	9.00	—
WML31225RJ	ML31225RJ	3		100k	49.75	19.50	9.00	—
WML41225RJ	ML41225RJ	4		100k	62.75	19.50	9.00	—

3-Phase, 4-Wire SN, Incoming and 1-Phase, 3-Wire SN Outgoing, Lever Bypass, 5-Jaw Sockets^{②⑤}

Max. tenant breaker (Amps): 225								
WML12225RJ	ML12225RJ	1	QS, QSH, QSHH, HQS, HQSH, QP, QPH, HQP, MP-T, MP-HT, MP-MT	100k	27.75	19.50	9.00	1-AB
WML22AB225RJ	ML22AB225RJ	2		100k	40.75	19.50	9.00	1-AC, 1-BC
WML22BC225RJ	ML22BC225RJ	2		100k	40.75	19.50	9.00	1-AC, 1-AB
WML22CA225RJ	ML22CA225RJ	2		100k	40.75	19.50	9.00	1-AB, 1-BC
WML32225RJ	ML32225RJ	3		100k	49.75	19.50	9.00	1-AB, 1-BC, 1-CA
WML42AB225RJ	ML42AB225RJ	4		100k	62.75	19.50	9.00	2-AB, 1-BC, 1-CA
WML42BC225RJ	ML42BC225RJ	4		100k	62.75	19.50	9.00	1-AB, 2-BC, 1-CA
WML42CA225RJ	ML42CA225RJ	4		100k	62.75	19.50	9.00	1-AB, 1-BC, 2-CA

① Dimensions shown are representative of outside box dimensions and do not include allowances for mounting bumps, hubs, or hardware protrusions.

② Not for use on 3-phase, 4-wire delta systems.

③ Max AIC determined by maximum AIC of tenant breakers when used in conjunction with a meter socket. Higher overall ratings may be achieved through approved series rating combinations.

④ Are field phaseable.

⑤ Not field phaseable.

Power Mod

Type WML Lever Bypass Meter Stacks

- 100A/125A
1-4 position
- 1200A thru-bus
rating



Commercial Ringless Type Meter Stacks: Lever Bypass

Outdoor Catalog No.	Indoor Catalog No.	Meter Positions Per Stack	Breaker Provisions	Maximum AIC ^③	Dimensions (inches) ^①		
					Height	Width	Depth

3-Phase, 4-Wire SN, Incoming And Outgoing, Lever Bypass, 7-Jaw Sockets^⑤

Max. tenant breaker (Amps) ^{①②} : 100							
WML13100RJ ^②	ML13100RJ ^②	1	QP, MP-T, QPH, MP-HT, HQP, MP-MT	65k	27.75	23.50	9.00
WML23100RJ ^②	ML23100RJ ^②	2		65k	40.75	23.50	9.00
WML33100RJ ^②	ML33100RJ ^②	3		65k	49.75	23.50	9.00
WML43100RJ ^②	ML43100RJ ^②	4		65k	62.75	23.50	9.00
Max. tenant breaker (Amps) ^{①②} : 225							
WML13225RJ	ML13225RJ	1	QR2, QRH2, MQ, MQH, MQL, HQR2, HQR2H	100k	27.75	23.50	9.00
WML23225RJ	ML23225RJ	2		100k	40.75	23.50	9.00
WML33225RJ	ML33225RJ	3		100k	49.75	23.50	9.00
WML43225RJ	ML43225RJ	4		100k	62.75	23.50	9.00

① Dimensions shown are representative of outside box dimensions and do not include allowances for mounting bumps, hubs, or hardware protrusions.

② 3-pole breakers only.

③ Max AIC determined by maximum AIC of tenant breakers when used in conjunction with a meter socket. Higher overall ratings may be achieved through approved series rating combinations.

④ Rated for use with 240/120V Delta systems.

Power Mod

Type WML Lever Bypass Meter Stacks

- 400A 1-2 position
- 1200A thru-bus rating
- 25-35k AIC



Commercial Ringless Type Meter Stacks: Lever Bypass

Outdoor Catalog No.	Meter Positions Per Stack	Breaker Provisions	Maximum AIC ^③	Dimensions (inches) ^①			Socket Phasing	Stack Phasing
				Height	Width	Depth		

1-Phase, 3-Wire SN, Incoming and Outgoing, Lever Bypass, 5-Jaw Sockets^②

Max. tenant breaker (Amps): 400								
WML11400RJ [®]	1	JXD62B400	25k	44.00	16.31	9.69	—	—
WML21400RJ [®]	2	Factory installed	25k	70.38	23.00	9.69	—	—

3-Phase, 4-Wire SN, Incoming and 1-Phase, 3-Wire SN Outgoing, Lever Bypass, 5-Jaw Sockets^{②⑤}

Max. tenant breaker (Amps): 400								
WML12400RJ [®]	1	JXD62B400	25k	44.00	16.31	9.69	1-AB	—
WML22400RJ [®]	2	Factory installed	25k	70.38	23.00	9.69	1-AB, 1-BC	—

3-Phase, 4-Wire SN, Incoming and Outgoing, Lever Bypass, 7-Jaw Sockets^②

Max. tenant breaker (Amps) [®] : 400								
WML13400RJ [®]	1	JXD63B400	25k	44.00	16.31	9.69	—	—
WML23400RJ [®]	2	Factory installed	25k	70.38	23.00	9.69	—	—

Commercial Ringless Type Meter Stacks: Lever Bypass

Max. tenant breaker (Amps) [®] : 400								
WML11400RJH	1	CJD6-A	35k	51.06	16.34	9.75	—	1 Ph in / 1 Ph out
WML12400RJH	1		35k	51.06	16.34	9.75	—	3 Ph in / 1 Ph out
WML13400RJH	1		35k	51.06	16.34	9.75	—	3 Ph in / 3 Ph out

Alternate Amperage Breakers For 1 Position Stacks

Add Suffix ➔	Suffix	Breaker Amperage
	T1	200A
	T19	225A
	T2	250A
	T3	300A
T4	350A	

Alternate Amperage Breakers For 2 Position Stacks

Add Suffix ➔	Suffix	Breaker Amperage	Suffix	Breaker Amperage
	T5	200A/200A	T15	300A/400A
	T6	200A/250A	T16	350A/350A
	T7	200/300A	T17	350A/400A
	T8	200/350A	T18	250A/250A
	T9	200/400A	T20	200A/225A
	T10	250A/300A	T21	225A/225A
	T11	250A/350A	T22	225A/250A
	T12	250A/400A	T23	225A/300A
	T13	300A/300A	T24	225A/350A
	T14	300A/350A	T25	225A/400A

- ① Dimensions shown are representative of outside box dimensions and do not include allowances for mounting bumps, hubs, or hardware protrusions.
- ② Not for use on 3-phase, 4-wire delta systems.
- ③ Max AIC determined by maximum AIC of tenant breakers when used in conjunction with a meter socket. Higher overall ratings may be achieved through approved series rating combinations.
- ④ Alternate amperage breakers are available. Please see tables on left for suffix that needs to be added. Additional lead time may apply. Contact sales office for details.
- ⑤ Not field phaseable.
- ⑥ 3-pole breakers only

Power Mod

Type WML Lever Bypass Meter Stacks

Fusible Switch Lever Bypass Meter Stacks

Fusible Switch Lever Bypass Meter stacks This Commercial Lever Bypass meter stacks (type WML) feature a 400 Amp - class T - fusible pull out assembly..

Features include:

- QuickSystem™ features
- High-quality, time proven Talon HQ sockets
- Removable back knockout plate to facilitate wiring
- Available in single and three phases designs
- Single position with 400amp tenant main
- All lever bypass stacks are ringless.

Lever Bypass With Fusible Switch Quick Reference:

- 400A 1 position
- 1200A thru bus rating
- UL Standard #UL67
- UL file #E27100
- AIC rating 100KAIC
- Voltage
 - Single phase 120/240V AC Max
 - Three phase in, single phase out 208Y/120V AC
 - Three Phase 240V AC Max
- All swing latches and rivets are stainless steel
- Outdoor = NEMA 3R rated
- Indoor = NEMA 1 rated
- G90 galvanized steel
- ANSI 61 paint
- Custom options available.



QuickConnect™
Included

Power Mod

Type WML Lever Bypass Meter Stacks

- 400A 1 position
- 1200A thru-bus rating
- 400A Class T fuse (not included)



Fusible Switch Lever Bypass Ringless Meter Stacks

Outdoor Catalog No.	Indoor Catalog No.	Meter Positions Per Stack	Breaker Provisions	Maximum AIC	Dimensions (inches) [Ⓞ]		
					Height	Width	Depth
Max. Tenant Fuse (Amps): 400							
Single-Phase In/Out							
WML11400RJFS	ML11400RJFS	1	Class T fuse	100K	38.31	16.34	11.22
Three-Phase In/ Single-Phase Out							
WML12400RJFS	ML12400RJFS	1	Class T fuse	100K	38.31	16.34	11.22
Three-Phase In/Out							
WML13400RJFS	ML13400RJFS	1	Class T fuse	100K	38.31	16.34	11.22

[Ⓞ] Dimensions shown are representative of the outside box dimensions and do not include allowances for mounting bumps, hubs, or hardware protrusions.



Power Mod

Type WMLZF and WMLZ Utility Meter Stacks: Knockout Diagrams

Fusible Switch Lever Bypass Meter Stacks

The WMLZ and WMLZF lever bypass meter stacks are designed to allow the use of class T (400amp max) fuses ahead of all meter positions where the local serving utility may require it. WMLZF stacks feature a 400amp fusible pull out assembly which connects to a secondary 400amp thru bus that can feed downstream meter stacks. The WMLZ stacks include the secondary 400amp thru bus that can connect from the WMLZF meter stacks. The standard Power Mod 1200amp thru bus "passes thru" to feed downstream modules - the meter sockets in WMLZ and WMLZF do NOT connect directly to the 1200amp thru bus - only to the 400amp thru bus.

Features include:

- QuickSystem™ features
- High-quality, time-proven Talon HQ sockets
- 125 Amp capability for 3-phase in/single-phase out
- 3 to 6 positions in both the fused stack and the expansion stack
- 400 Amp class T fusible-pullout in WMLZF stacks
- Secondary 400 amp thru bus to supply power to downstream sockets

Xcel Residential Lever Bypass Quick Reference:

- 125A 3 – 6 position
- 1200A thru-bus rating
- 400A secondary thru-bus rating and vertical bus rating
- UL Standard # UL67
- UL file #E27100
- AIC rating (100K)
- Voltage -Three-phase in/ single-phase out 120/240V AC max
- All swing latches and rivets are stainless steel
- Outdoor = NEMA 3R rated
- Indoor = NEMA 1R rated
- G90 galvanized steel
- ANSI 61 paint
- Custom options available.

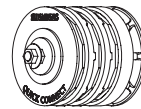

QuickConnect™
Included

Power Mod

Type WMLZF and WMLZ Utility Meter Stacks: Knockout Diagrams

- 125A 3 – 6 position
- 1200A thru-bus
- 400A 2nd thru-bus
- 400A vertical bus



Fused Residential Ringless Type Stacks: Lever Bypass

Outdoor Catalog No.	Indoor Catalog No.	Meter Positions Per Stack	Breaker Provisions	Maximum AIC	Dimensions (inches)		
					Height	Width	Depth
3-Phase, 4-Wire SN, Incoming and 1Phase, 3-Wire SN, Outgoing, Lever Bypass, 5-Jaw Sockets							
Max. tenant breaker (Amps): 125							
WMLZF32125RJ	MLZF32125RJ	3	QP, MP-T, QPH, HQP, MP-HT, MP-MT	65k	54.06	14.61	11.51
WMLZF42125RJ	MLZF42125RJ	4		65k	64.06	14.61	11.51
WMLZF52125RJ	MLZF52125RJ	5		65k	74.06	14.61	11.51
WMLZF62125RJ	MLZF62125RJ	6		65k	84.06	14.61	11.51

Non-Fused Residential Ringless Type Stacks: Lever Bypass

Outdoor Catalog No.	Indoor Catalog No.	Meter Positions Per Stack	Breaker Provisions	Maximum AIC	Dimensions (inches)		
					Height	Width	Depth
3-Phase, 4-Wire SN, Incoming and 1Phase, 3-Wire SN, Outgoing, Lever Bypass, 5-Jaw Sockets							
Max. tenant breaker (Amps): 125							
WMLZ32125RJ	MLZ32125RJ	3	QP, MP-T, QPH, HQP, MP-HT, MP-MT	65k	54.06	14.61	11.51
WMLZ42125RJ	MLZ42125RJ	4		65k	64.06	14.61	11.51
WMLZ52125RJ	MLZ52125RJ	5		65k	74.06	14.61	11.51
WMLZ62125RJ	MLZ62125RJ	6		65k	84.06	14.61	11.51

Accessories

Catalog No.	Description
ECWMLZFBUS	WMLZ's thru bussing attachment kit (contains 3 bus bars)
ECWMLZEP	End enclosure plate WMLZ's and WMLZF's
ECWMLZBP	Bottom enclosure plate WMLZ and WMLZF
ECWML10	10 inch WML replacement cover

* Every WMLZ comes with a ECWMLZFBUS

Power Mod

Applications: WMLZ/ WMLZF – Fusible Residential Lever Bypass Meter Stacks

Flow of Current



- 1 Cables land on a tap box and current enters Power Mod line up on the main Thru Bus.
- 2 Current is directed from the main thru bus down onto the WMLZF's vertical bus and into the 400 amp fuse pull out.
- 3 The current then goes up on the WMLZF's vertical bus to feed the sockets.
- 4 WMLZ's must be fed by a secondary thru bus from the WMLZF's
*Additional connections are required between the WMLZ and WMLZF.
- 5 The current then flows up from the secondary thru bus and on to the vertical bus to feed the sockets in the WMLZ's.
*More than one WMLZ can be fed from 1 WMLZF.
- 6 The main thru bus is used as a pass thru on the WMLZ's for any additional modules attached to the line up.
*Quick Connect MUST be used between every module to maintain the line ups Neutral bonding, even if there are no extra modules attached at the end of the line up.

Power Mod

Type WMT Test Block Bypass Meter Stacks

Test Block Bypass Meter Stacks

Commercial Test Block Bypass Meter Stacks (type WMT) are designed to meet the requirements of those utilities specifying test block bypass meter sockets for commercial applications in areas subscribing to the EUSERC standards.

Features include:

- QuickSystem™ features
- High-quality, time-proven Siemens SMM switch-board meter socket
- Removable back knockout plate to facilitate wiring
- 225 Amp capability in single and three phase designs
- Up to 3 positions with 225 Amp tenant mains
- Wiring flexibility - tenant mains require only a single bend
- Three phase input, single phase output modules
- In line wiring: side knockouts allow wiring for adjacent units to pass through

Test Block Bypass Quick Reference

- 225A 1-3 positions
- 1200A thru-bus rating
- UL Standard #'s UL67
- UL file # E27100
- AIC rating (100K)
- Voltage
 - 1 phase 120/240V AC Max
 - 3 phase in 1 phase out 120Y/208V AC Max
 - 3 phase 240V AC Max
- All swing latches and rivets are stainless steel.
- Outdoor= NEMA 3R rated
- Indoor= NEMA 1R rated
- G90 galvanized Steel
- ANSI 61 Paint
- EUSERC drawing #'s 312 and 353
- Custom options available.



QuickConnect™
Included

Power Mod

Type WMT Test Block Bypass Meter Stacks

- 225A 1-3 positions
- 1200A thru-bus rating
- AIC Rating (100k)



Commercial ring type meter stacks: Test Block Bypass^③

Outdoor Catalog No.	Indoor Catalog No.	Meter Positions Per Stack	Breaker Provisions	Maximum AIC	Dimensions (inches) ^①			Phase	Knockout Diagram
					Height	Width	Depth		

1-phase, 3-wire SN, incoming and outgoing, test block bypass, 4-jaw sockets^{② ④}

Max. tenant breaker (Amps): 225									
WMT11225	MT11225	1	QS, QSH, QSHH, HQS, HQSH, QP, QPH, HQP, MP-T, MP-HT, MP-MT	100k	40.50	21.50	9.00	—	TB-1
WMT21225	MT21225	2			46.00	21.50	9.00	—	TB-2
WMT31225	MT31225	3			65.50	21.50	9.00	—	TB-3

3-phase, 4-wire SN, incoming and 1-phase, 3-wire SN outgoing, test block bypass, 5-jaw sockets^{② ⑤}

Max. tenant breaker (Amps): 225									
WMT12225J	MT12225J	1	QS, QSH, QSHH, HQS, HQSH, QP, QPH, HQP, MP-T, MP-HT, MP-MT	100k	40.50	21.50	9.00	AB	TB-1
WMT22AB225J	MT22AB225J	2			46.00	21.50	9.00	1-BC, 1-CA	TB-2
WMT22BC225J	MT22BC225J	2			46.00	21.50	9.00	1-AB, 1-CA	
WMT22CA225J	MT22CA225J	2			46.00	21.50	9.00	1-AB, 1-BC	
WMT32225J	MT32225J	3			65.50	21.50	9.00	1-AB, 1-BC, 1-CA	TB-3

3-phase, 4-wire SN, incoming and outgoing, test block bypass, 7-jaw sockets^④

Max. tenant breaker (Amps): 225									
WMT13225J	MT13225J	1	QR2, QRH2, HQR2, HQR2H, MQ, MQH, MQL	100k	40.50	25.50	9.00	—	TB-4
WMT23225J	MT23225J	2			46.00	25.50	9.00	—	TB-5
WMT33225J	MT33225J	3			65.50	25.50	9.00	—	TB-6

① Dimensions shown are representative of outside box dimensions and do not include allowances for mounting bumps, hubs, or hardware protrusions.

② Not for use on 3-phase, 4-wire delta systems.
 ③ Max AIC determined by maximum AIC of tenant breakers when used in conjunction with a meter socket.

④ Rated for use with 240/120V Delta systems.
 ⑤ Not field phaseable.
 ⑥ Field installable fifth Jaw Kit available (ECMT5).

Power Mod

Type WMK K-Base Meter Stacks

K-Base Meter Stacks

Commercial K-Base Meter Stacks (type WMK) are designed to meet the requirements of those utilities specifying bolt-in meter sockets for 400 and 600 Amp residential and commercial applications.

Features include:

- QuickSystem™ features
- Exclusive Landis & Gyr K4, K5, and K7 meter sockets
- 1 position K4, K5, K7 modules with 400 and 600 Amp tenant mains
- 2 position K7 module with 400 Amp tenant main
- Space saving design

K-Base quick reference

- 400A and 600A 1-2 positions
- 1200A Thru bus-rating
- UL Standard # UL67
- UL file # E27100
- AIC Rating (25k)
- Voltage
 - Single Phase 120/240V AC Max
 - Three In Single Phase Out 208Y/120V AC
 - Three Phase 240V AC Max
- All swing latches and rivets are stainless steel
- NEMA 3R rated
- G90 Galvanized Steel
- ANSI 61 Paint
- Custom options available.



Power Mod

Type WMK K-Base Meter Stacks

- 400A and 600A
1-2 positions
- 1200A Thru bus-
rating
- AIC Rating (25k)



Commercial ringless type meter stacks: K-Base bolt-in, 25k AIC^③ ⑥

Catalog No.	Meter Positions Per Stack	Max. Tenant Breaker (Amps)	Breaker Provision ^④	Maximum AIC Rating	Dimensions (inches) ^①			Phase	Knockout Diagram
					Height	Width	Depth		

1-phase, 3-wire SN, incoming and outgoing, K4 K-Base bolt-in

WMK11400R ^④	1	400	JXD62B400 Factory Inst.	25k	54.00	19.25	10.00	—	KB-1
WMK11600R ^②	1	600	LXD62B600 Factory Inst.	25k	54.00	19.25	10.00	—	

3-phase, 4-wire SN, incoming and 1-phase, 3-wire SN outgoing, K5 K-Base bolt-in^② ⑥

WMK12400RJ ^③	1	400	JXD62B400 Factory Inst.	25k	54.00	19.25	10.00	AB	KB-2
WMK22400RJ	2	400	JXD62B400 Factory Inst.	25k	72.87	27.00	11.00	AC	KB-3

3-phase, 4-wire SN, incoming and outgoing, K7 K-Base bolt-in^⑤

WMK13400RJ ^④	1	400	JXD63B400 Factory Inst.	25k	54.00	19.25	10.00	—	KB-2
WMK23400RJ ^④	2				72.88				
WMK13600RJ ^②	1	600	LXD63B600 Factory Inst.	25k	54.00	19.25	10.00	—	KB-2

Alternate amperage breakers

Add Suffix ➔	1 Meter Position Per Stack	Breaker Amperage
		200A
		250A
		300A
		350A
	T19	450A
		500A

Add Suffix ➔	2 Meter Positions Per Stack	Breaker Amperage
		200A/200A
		200A/250A
		200A/300A
		200A/350A
		200A/400A
		250A/300A
		250A/350A
		250A/400A
		300A/300A
		300A/350A
		300A/400A
		350A/350A
	350A/400A	
	250A/250A	

① Dimensions shown are representative of outside box dimensions and do not include allowances for mounting bumps, hubs, or hardware protrusions.

② Not for use on 3-Phase 4-wire delta systems.

③ Max AIC determined by maximum AIC of tenant breakers when used in conjunction with a meter socket. Higher overall ratings may be achieved through approved series rating combinations.

④ Alternate amperage breakers are available. Please see table below for suffix that needs to be added for ordering. Extended leadtime may apply. Contact sales office for more details.

⑤ Rated for use with 240/120V Delta systems

⑥ Not field phaseable

⑦ Alternate amperage breakers are available (T19 and T20). Please see table at left for suffix that needs to be added for ordering. Extended leadtime may apply. Contact sales office for more details.

Power Mod

Type WC House Power Module

WC Series House Power Module

Power Mod's patented WC family of house power modules offers the ability to combine power distribution to branch circuits within a module that is connected directly to the thru bus. This reduces wall space needed, decreases labor and material cost (for installing a separate panel), and simplifies the electrical distribution system.

Key Features of the WC family are:

- Ring or Ringless Covers (horn bypass available with ringless)
- Three or single phase thru bus with single phase output
- 20 space, 40 circuit 100K AIC rated interior
- Available subfeed breaker which can be used for large remote loads (such as elevators) or alternative energy inputs (solar)
- Removable knock out plate
- Load wires can exit out of the top, back, or bottom

The line of WC house power modules allow for un-precedented flexibility and savings. All of this while featuring the industry-leading QuickSystem that allows for the fastest install time.

Series House Power Module quick reference

- 1 Position, Single Phase Meter Socket
- 250 Amp maximum rating per device. Load center interior limited to 225 Amps max. 1200 Amp thru-bus rating
- UL standard 67
- UL file no. E27100
- AIC rating: 100k
- Voltage:
 - Single phase 120/240V AC max.
 - Three phase in single phase out
 - 120/208V AC max.
 - 240/120V AC max.
- All swing latches and rivets are stainless steel.
- Outdoor= NEMA 3R rated
- 20 space, 40 circuit PL Series copper bus interior
- G90 galvanized steel
- ANSI 61 paint
- Optional subfeed or alternative energy input (solar) up to 125 Amps.
- Custom options available.



Power Mod

Type WC House Power Module: Ring Style

Main Features:

- 1 Position, Single Phase Meter Socket
- 250A maximum rating per device. Load center interior limited to 225A max.
- 1200 Amp thru-bus rating

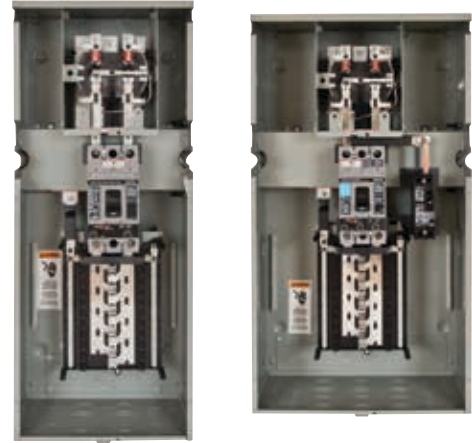

Residential 4-Jaw Ring Type Meter-Loadcenter Stacks: 1-Phase, 3-wire, SN, Thru Bus, Distribution, and Subfeed

Catalog No.	Main Breaker - Distribution ^②		Distribution		Subfeed Breaker (Type HED4) ^②	Maximum AIC	Dimensions (inches) ^①			Knockout Diagram
	Amperage	Type	Spaces	Circuits	Amperage		Height	Width	Depth	
WC2040B1T1	225	HFXD6	20	40	N/A	100k	39.10	16.22	12.14	WC-1
WC2040B1T2	200	HFXD6	20	40	50	100k	39.10	21.75	12.14	WC-2
WC2040B1T3	175	HFXD6	20	40	60	100k	39.10	21.75	12.14	
WC2040B1T4	175	HFXD6	20	40	70	100k	39.10	21.75	12.14	
WC2040B1T5	150	HFXD6	20	40	80	100k	39.10	21.75	12.14	
WC2040B1T6	150	HFXD6	20	40	90	100k	39.10	21.75	12.14	
WC2040B1T7	150	HFXD6	20	40	100	100k	39.10	21.75	12.14	
WC2040B1T8	150	HFXD6	20	40	110	100k	39.10	21.75	12.14	
WC2040B1T9	125	HFXD6	20	40	125	100k	39.10	21.75	12.14	

Residential 5-Jaw Ring Type Meter-Loadcenter Stacks: 3-Phase, 4-wire SN, Thru Bus and 1-Phase, 3-wire, SN, Distribution and Subfeed

Catalog No.	Main Breaker - Distribution ^②		Distribution		Subfeed Breaker (Type HED4) ^②	Max. AIC	Dimensions (inches) ^①			Phasing ^③	Knockout Diagram
	Amperage	Type	Spaces	Circuits	Amperage		Height	Width	Depth		
WC2040B2T1J	225	HFXD6	20	40	N/A	100k	39.10	16.22	12.14	AC	WC-1
WC2040B2T2J	200	HFXD6	20	40	50	100k	39.10	21.75	12.14	AC	WC-2
WC2040B2T3J	175	HFXD6	20	40	60	100k	39.10	21.75	12.14	AC	
WC2040B2T4J	175	HFXD6	20	40	70	100k	39.10	21.75	12.14	AC	
WC2040B2T5J	150	HFXD6	20	40	80	100k	39.10	21.75	12.14	AC	
WC2040B2T6J	150	HFXD6	20	40	90	100k	39.10	21.75	12.14	AC	
WC2040B2T7J	150	HFXD6	20	40	100	100k	39.10	21.75	12.14	AC	
WC2040B2T8J	150	HFXD6	20	40	110	100k	39.10	21.75	12.14	AC	
WC2040B2T9J	125	HFXD6	20	40	125	100k	39.10	21.75	12.14	AC	

① Dimensions shown are representative of outside box dimensions and do not include allowances for mounting bumps, endwalls, covers, hubs, or hardware protrusions. Dimensions are subject to change.

② Breakers are factory installed.
③ Can be re-phased in the field.

Power Mod

Type WC House Power Module: Ringless Style

Main Features:

- 1 Position, Single Phase Meter Socket
- 250A maximum rating per device. Load center interior limited to 225A max.
- 1200 Amp thru-bus rating

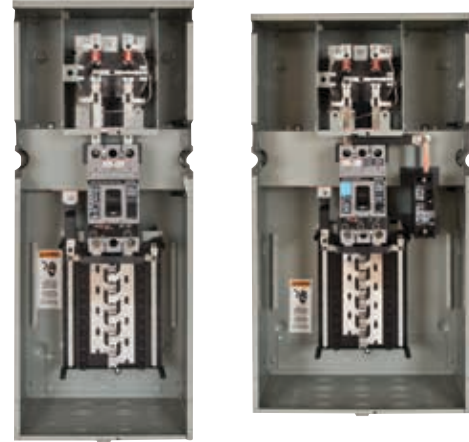

Residential 4 or 5-Jaw Ringless Type Meter-Loadcenter Stacks: 1-Phase, 3-wire, SN, Thru Bus, Distribution, and Subfeed

Catalog No.			Main Breaker-Distribution ^②		Distribution		Subfeed Breaker (Type HED4) ^②	Max. AIC	Dimensions ^①			Knockout Diagram
No Bypass, 4J	No Bypass, 5J	Horn Bypass, 5J	Amp.	Type	Spaces	Circuits	Amperage		Height	Width	Depth	
WC2040B1T1R	WC2040B1T1RJ	WC2040B1T1RJB	225	HFXD6	20	40	N/A	100k	39.10	16.22	12.14	WC-1
WC2040B1T2R	WC2040B1T2RJ	WC2040B1T2RJB	200	HFXD6	20	40	50	100k	39.10	21.75	12.14	WC-2
WC2040B1T3R	WC2040B1T3RJ	WC2040B1T3RJB	175	HFXD6	20	40	60	100k	39.10	21.75	12.14	
WC2040B1T4R	WC2040B1T4RJ	WC2040B1T4RJB	175	HFXD6	20	40	70	100k	39.10	21.75	12.14	
WC2040B1T5R	WC2040B1T5RJ	WC2040B1T5RJB	150	HFXD6	20	40	80	100k	39.10	21.75	12.14	
WC2040B1T6R	WC2040B1T6RJ	WC2040B1T6RJB	150	HFXD6	20	40	90	100k	39.10	21.75	12.14	
WC2040B1T7R	WC2040B1T7RJ	WC2040B1T7RJB	150	HFXD6	20	40	100	100k	39.10	21.75	12.14	
WC2040B1T8R	WC2040B1T8RJ	WC2040B1T8RJB	150	HFXD6	20	40	110	100k	39.10	21.75	12.14	
WC2040B1T9R	WC2040B1T9RJ	WC2040B1T9RJB	125	HFXD6	20	40	125	100k	39.10	21.75	12.14	

Residential 5-Jaw Ringless Type Meter-Loadcenter Stacks: 3-Phase, 4-wire SN, Thru Bus and 1-Phase, 3-wire, SN, Distribution and Subfeed

Catalog No.		Main Breaker-Distribution ^②		Distribution		Subfeed Breaker (Type HED4) ^②	Max. AIC	Dimensions ^①			Phasing ^③	Knockout Diagram
No Bypass	Horn Bypass	Amp.	Type	Spaces	Circuits	Amperage		Height	Width	Depth		
WC2040B2T1RJ	WC2040B2T1RJB	225	HFXD6	20	40	N/A	100k	39.10	16.22	12.14	AC	WC-1
WC2040B2T2RJ	WC2040B2T2RJB	200	HFXD6	20	40	50	100k	39.10	21.75	12.14	AC	WC-2
WC2040B2T3RJ	WC2040B2T3RJB	175	HFXD6	20	40	60	100k	39.10	21.75	12.14	AC	
WC2040B2T4RJ	WC2040B2T4RJB	175	HFXD6	20	40	70	100k	39.10	21.75	12.14	AC	
WC2040B2T5RJ	WC2040B2T5RJB	150	HFXD6	20	40	80	100k	39.10	21.75	12.14	AC	
WC2040B2T6RJ	WC2040B2T6RJB	150	HFXD6	20	40	90	100k	39.10	21.75	12.14	AC	
WC2040B2T7RJ	WC2040B2T7RJB	150	HFXD6	20	40	100	100k	39.10	21.75	12.14	AC	
WC2040B2T8RJ	WC2040B2T8RJB	150	HFXD6	20	40	110	100k	39.10	21.75	12.14	AC	
WC2040B2T9RJ	WC2040B2T9RJB	125	HFXD6	20	40	125	100k	39.10	21.75	12.14	AC	

① Dimensions shown are representative of outside box dimensions and do not include allowances for mounting bumps, endwalls, covers, hubs, or hardware protrusions. Dimensions are subject to change.

② Breakers are factory installed.
③ Can be re-phased in the field.

Power Mod

Type WCL Lever Bypass House Power Module

WCL Series House Power Module

Power Mod's patented WCL (lever bypass) family of house power modules offers the ability to combine power distribution to branch circuits within a module that is connected directly to the thru bus. This reduces wall space needed, decreases labor and material cost (for installing a separate panel), and simplifies the electrical distribution system.

Key Features of the WCL family are:

- Talon HQ Lever Bypass ringless meter socket
- Phasing:
 - Single phase thru bus with single phase HQ socket and 20 space 40 circuit PL Series copper interior
 - Three phase thru bus with single phase HQ socket (phased AC) and 20 space 40 circuit PL Series copper interior
 - Three phase thru bus with three phase HQ socket and 24 space 42 circuit PL Series copper interior
- 100K AIC
- Available subfeed breaker which can be used for large remote loads (such as elevators) or alternative energy inputs (solar)
- Removable knock out plate
- Load wires can exit out of the top, back, or bottom

The line of WCL house power modules allow for un-precedented flexibility and savings. All of this while featuring the industry-leading QuickSystem that allows for the fastest install time.

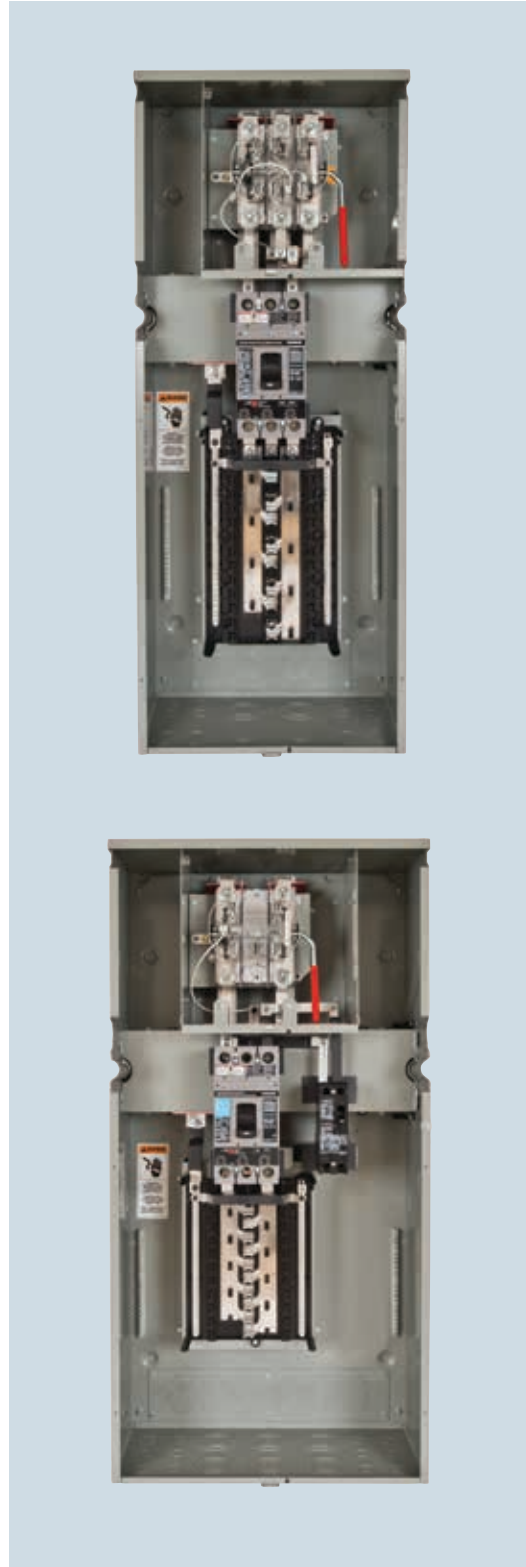

Power Mod

Type WCL Lever Bypass House Power Module

Main Features:

- Talon HQ Lever Bypass Meter Socket
- 1 Position, Single Phase Meter Socket
- 250A maximum rating per device. Load center interior limited to 225A max.
- 1200A thru-bus rating

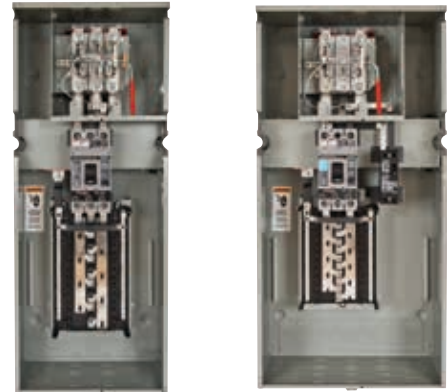

Residential 4 or 5-Jaw Ringless Type Meter-Loadcenter Stacks: 1-Phase, 3-wire, SN, Thru Bus, Distribution, and Subfeed

Catalog No.	Main Breaker-Distribution ^②		Distribution		Subfeed Breaker (Type HED4) ^②	Max. AIC	Dimensions ^①			Knockout Diagram
	Amperage	Type	Spaces	Circuits	Amperage		Height	Width	Depth	
WCL2040B1T1RJ	225	HFXD6	20	40	N/A	100k	44.63	17.93	12.14	WCL-1
WCL2040B1T2RJ	200	HFXD6	20	40	50	100k	44.63	22.35	12.14	WCL-2
WCL2040B1T3RJ	175	HFXD6	20	40	60	100k	44.63	22.35	12.14	
WCL2040B1T4RJ	175	HFXD6	20	40	70	100k	44.63	22.35	12.14	
WCL2040B1T5RJ	150	HFXD6	20	40	80	100k	44.63	22.35	12.14	
WCL2040B1T6RJ	150	HFXD6	20	40	90	100k	44.63	22.35	12.14	
WCL2040B1T7RJ	150	HFXD6	20	40	100	100k	44.63	22.35	12.14	
WCL2040B1T8RJ	150	HFXD6	20	40	110	100k	44.63	22.35	12.14	
WCL2040B1T9RJ	125	HFXD6	20	40	125	100k	44.63	22.35	12.14	

Commercial 5-Jaw Ringless Type-Lever Bypass Meter-Loadcenter Stacks: 3-Phase, 4-wire SN, Thru Bus and 1-Phase, 3-wire, SN, Distribution and Subfeed

Catalog No.	Main Breaker-Distribution ^②		Distribution		Subfeed Breaker (Type HED4) ^②	Max. AIC	Dimensions ^①			Phasing ^③	Knockout Diagram
	Amperage	Type	Spaces	Circuits	Amperage		Height	Width	Depth		
WCL2040B2T1RJ	225	HFXD6	20	40	N/A	100k	44.63	17.93	12.14	AC	WCL-1
WCL2040B2T2RJ	200	HFXD6	20	40	50	100k	44.63	22.35	12.14	AC	WCL-2
WCL2040B2T3RJ	175	HFXD6	20	40	60	100k	44.63	22.35	12.14	AC	
WCL2040B2T4RJ	175	HFXD6	20	40	70	100k	44.63	22.35	12.14	AC	
WCL2040B2T5RJ	150	HFXD6	20	40	80	100k	44.63	22.35	12.14	AC	
WCL2040B2T6RJ	150	HFXD6	20	40	90	100k	44.63	22.35	12.14	AC	
WCL2040B2T7RJ	150	HFXD6	20	40	100	100k	44.63	22.35	12.14	AC	
WCL2040B2T8RJ	150	HFXD6	20	40	110	100k	44.63	22.35	12.14	AC	
WCL2040B2T9RJ	125	HFXD6	20	40	125	100k	44.63	22.35	12.14	AC	

Commercial 7-Jaw Ringless Type-Lever Bypass Meter-Loadcenter Stacks: 3-Phase, 4-wire SN, Thru Bus, Distribution and Subfeed

Catalog No.	Main Breaker-Distribution ^②		Distribution		Subfeed Breaker (Type HED4) ^②	Max. AIC	Dimensions ^①			Phasing ^③	Knockout Diagram
	Amperage	Type	Spaces	Circuits	Amperage		Height	Width	Depth		
WCL2442B3T1RJ	225	HFXD6	24	42	N/A	100k	44.63	17.93	12.14	AC	WCL-1
WCL2442B3T2RJ	200	HFXD6	24	42	50	100k	44.63	22.35	12.14	AC	WCL-2
WCL2442B3T3RJ	175	HFXD6	24	42	60	100k	44.63	22.35	12.14	AC	
WCL2442B3T4RJ	175	HFXD6	24	42	70	100k	44.63	22.35	12.14	AC	
WCL2442B3T5RJ	150	HFXD6	24	42	80	100k	44.63	22.35	12.14	AC	
WCL2442B3T6RJ	150	HFXD6	24	42	90	100k	44.63	22.35	12.14	AC	
WCL2442B3T7RJ	150	HFXD6	24	42	100	100k	44.63	22.35	12.14	AC	
WCL2442B3T8RJ	150	HFXD6	24	42	110	100k	44.63	22.35	12.14	AC	
WCL2442B3T9RJ	125	HFXD6	24	42	125	100k	44.63	22.35	12.14	AC	

① Dimensions shown are representative of outside box dimensions and do not include allowances for mounting

② bumps, endwalls, covers, hubs, or hardware protrusions. Dimensions are subject to change.

③ Breakers are factory installed. Cannot be re-phased in the field.

Power Mod

Type WCT Test Block Bypass House Power Module

WCT Series House Power Module

Power Mod's patented WCT (test-block bypass) family of house power modules offers the ability to combine power distribution to branch circuits within a module that is connected directly to the thru bus. This reduces wall space needed, decreases labor and material cost (for installing a separate panel), and simplifies the electrical distribution system.

Key Features of the WCT family are:

- Siemens SMM Switchboard ring-style meter socket
- Phasing:
 - Single phase thru bus with a single phase meter socket and 20 space 40 circuit PL Series copper interior
 - Three phase thru bus with a single phase meter socket (phased AC) and 20 space 40 circuit PL Series copper interior
 - Three phase thru bus with three phase meter socket and 24 space 42 circuit PL Series copper interior
- 100K AIC
- Available subfeed breaker which can be used for large remote loads (such as elevators) or alternative energy inputs (solar)
- Removable knock out plate
- Load wires can exit out of the top, back, or bottom

The line of WCT house power modules allow for un-precedented flexibility and savings. All of this while featuring the industry-leading QuickSystem that allows for the fastest install time.

Test Block Bypass Series House Power Module Quick Reference

- Siemens SMM Switchboard ring-style
- 1 position, Single Phase Meter Socket
- 250amp, maximum rating per device
- Load Center interior limited to 225amp max.
- 1200amp thru-bus rating
- UL standard #'s UL 67
- UL file # E270100
- AIC rating 100K
- Voltage
 - 1 phase 120/240V AC max
 - 3 phase 120/208V AC max
 - 3 phase 240/120V AC max
- All swing latches and rivets are stainless steel
- Outdoor= NEMA 3R rated
- Interiors:
 - 20 spaces/40 circuits single phase
 - 24 spaces/42 circuits 3 phase PL Series copper bus
- G90 galvanized steel
- ANSI 61 paint
- Optional subfeed or alternative energy input (solar) up to 125amps
- EUSERC drawing #'s 312 and 353
- Custom options available.

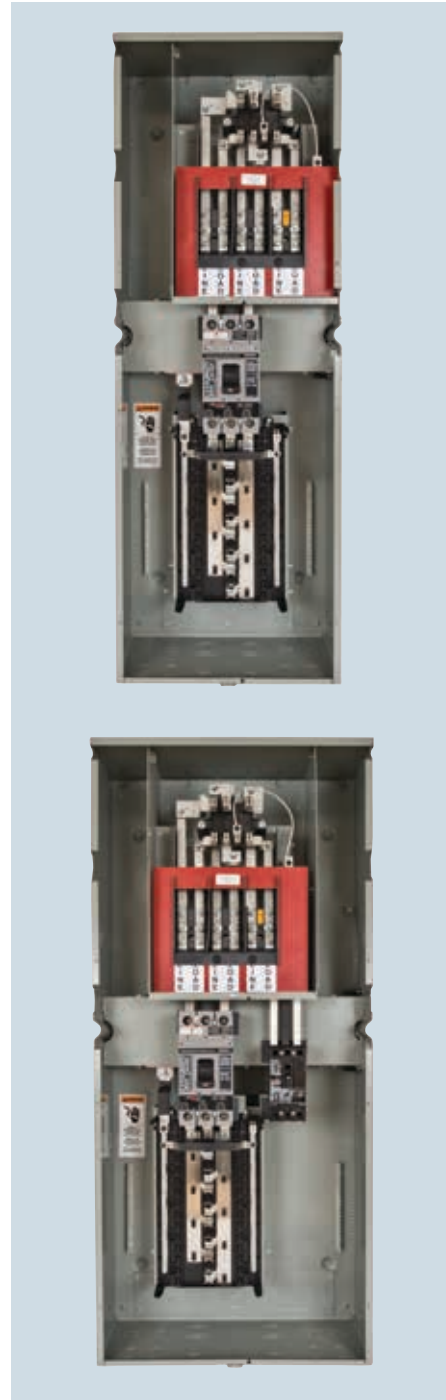

Power Mod

Type WCT Test Block Bypass House Power Module

Main Features:

- Siemens SMM Switchboard ring-style
- 1 Position, Single Phase Meter Socket
- 250A maximum rating per device. Load center interior limited to 225A max.
- 1200A thru-bus rating.



Commercial 4-Jaw Ring Type-Test Block Bypass Meter-Loadcenter Stacks: 1-Phase, 3-wire, SN, Thru Bus, Distribution, and Subfeed

Catalog No.	Main Breaker-Distribution ^②		Distribution		Subfeed Breaker (Type HED4) ^②	Max. AIC	Dimensions ^①			Knockout Diagram
	Amperage	Type	Spaces	Circuits	Amperage		Height	Width	Depth	
WCT2040B1T1	225	HFXD6	20	40	N/A	100k	52.1	18.42	12.14	WCT-1
WCT2040B1T2	200	HFXD6	20	40	50	100k	52.1	18.42	12.14	WCT-2
WCT2040B1T3	175	HFXD6	20	40	60	100k	52.1	18.42	12.14	
WCT2040B1T4	175	HFXD6	20	40	70	100k	52.1	18.42	12.14	
WCT2040B1T5	150	HFXD6	20	40	80	100k	52.1	18.42	12.14	
WCT2040B1T6	150	HFXD6	20	40	90	100k	52.1	18.42	12.14	
WCT2040B1T7	150	HFXD6	20	40	100	100k	52.1	18.42	12.14	
WCT2040B1T8	150	HFXD6	20	40	110	100k	52.1	18.42	12.14	
WCT2040B1T9	125	HFXD6	20	40	125	100k	52.1	18.42	12.14	

Commercial 5-Jaw Ring Type-Test Block Bypass Meter-Loadcenter Stacks: 3-Phase, 4-wire SN, Thru Bus and 1-Phase, 3-wire, SN, Distribution and Subfeed

Catalog No.	Main Breaker-Distribution ^②		Distribution		Subfeed Breaker (Type HED4) ^②	Max. AIC	Dimensions ^①			Phasing ^③	Knockout Diagram
	Amperage	Type	Spaces	Circuits	Amperage		Height	Width	Depth		
WCT2040B2T1J	225	HFXD6	20	40	N/A	100k	52.1	18.42	12.14	AC	WCT-1
WCT2040B2T2J	200	HFXD6	20	40	50	100k	52.1	18.42	12.14	AC	WCT-2
WCT2040B2T3J	175	HFXD6	20	40	60	100k	52.1	18.42	12.14	AC	
WCT2040B2T4J	175	HFXD6	20	40	70	100k	52.1	18.42	12.14	AC	
WCT2040B2T5J	150	HFXD6	20	40	80	100k	52.1	18.42	12.14	AC	
WCT2040B2T6J	150	HFXD6	20	40	90	100k	52.1	18.42	12.14	AC	
WCT2040B2T7J	150	HFXD6	20	40	100	100k	52.1	18.42	12.14	AC	
WCT2040B2T8J	150	HFXD6	20	40	110	100k	52.1	18.42	12.14	AC	
WCT2040B2T9J	125	HFXD6	20	40	125	100k	52.1	18.42	12.14	AC	

Commercial 7-Jaw Ring Type-Test Block Bypass Meter-Loadcenter Stacks: 3-Phase, 4-wire SN, Thru Bus, Distribution and Subfeed

Catalog No.	Main Breaker-Distribution ^②		Distribution		Subfeed Breaker (Type HED4) ^②	Max. AIC	Dimensions ^①			Phasing ^③	Knockout Diagram
	Amperage	Type	Spaces	Circuits	Amperage		Height	Width	Depth		
WCT2442B3T1J	225	HFXD6	24	42	N/A	100k	52.1	18.42	12.14	AC	WCT-1
WCT2442B3T2J	200	HFXD6	24	42	50	100k	52.1	18.42	12.14	AC	WCT-2
WCT2442B3T3J	175	HFXD6	24	42	60	100k	52.1	18.42	12.14	AC	
WCT2442B3T4J	175	HFXD6	24	42	70	100k	52.1	18.42	12.14	AC	
WCT2442B3T5J	150	HFXD6	24	42	80	100k	52.1	18.42	12.14	AC	
WCT2442B3T6J	150	HFXD6	24	42	90	100k	52.1	18.42	12.14	AC	
WCT2442B3T7J	150	HFXD6	24	42	100	100k	52.1	18.42	12.14	AC	
WCT2442B3T8J	150	HFXD6	24	42	110	100k	52.1	18.42	12.14	AC	
WCT2442B3T9J	125	HFXD6	24	42	125	100k	52.1	18.42	12.14	AC	

① Dimensions shown are representative of outside box dimensions and do not include allowances for

mounting bumps, endwalls, covers, hubs, or hardware protrusions. Dimensions are subject to change.

② Breakers are factory installed.
③ Cannot be re-phased in the field.

Power Mod

Type WSPD Surge Protection Modules

WSPD Surge Protection Modules

Surge protection modules for Power Mod (type WSPD) are thru-bus connected modules that allow the user to view surge status as well as access the SPD control panel without breaking the utility seal on the enclosure. An optional breaker disconnect is available to enable the end user to replace the SPD (surge protection device) without having to disconnect utility power to the Power Mod installation.

Features include:

- QuickSystem™ features
- 100, 200, 300, 400, 500kA ratings available
- External, vandal resistant and lockable clear cover over SPD control panel
- Single phase thru bus and three phase thru bus
- Optional breaker disconnect that opens phase and neutral to make SPD replacement quick and easy

Surge Protection Module quick reference

- 100-500 kA rating
- 1200amp thru-bus rating
- UL standard #67
- UL file # E27100
- AIC rating: 100K
- Voltage
 - Single phase 120/240V AC max
 - Three phase 240V AC max
- All swing latches and rivets are stainless steel
- NEMA 3R rated
- ANSI 61 paint
- Custom options available.

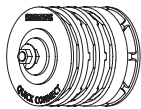

QuickConnect™
Included



Power Mod

Type WSPD Surge Protection Modules

Main Features:

- 100-500kA ratings
- 1200 amp thru-bus
- Suitable for 100k AIC applications

Lugs not required.



1-phase, 3-wire SN, 120/240V AC

Catalog No. (with HEG Breaker Disconnect)	Catalog No. (no disconnect)	Breaker Type	kA Surge Current ^②	Dimensions (inches) ^①			Knockout Diagram
				Height	Width	Depth	
WSPD1B10A	WSPD1N10A	HEG	100	29.19	13.38	7.91	WSPD-B = Breaker WSPD-N = No breaker
WSPD1B20A	WSPD1N20A	HEG	200	29.19	13.38	7.91	
WSPD1B30A	WSPD1N30A	HEG	300	29.19	13.38	7.91	
WSPD1B40A	WSPD1N40A	HEG	400	29.19	13.38	7.91	
WSPD1B50A	WSPD1N50A	HEG	500	29.19	13.38	7.91	

3-phase, 4-wire SN, Delta 240/120V AC

Catalog No. (with HEG Breaker Disconnect)	Catalog No. (no disconnect)	Breaker Type	kA Surge Current ^②	Dimensions (inches) ^①			Knockout Diagram
				Height	Width	Depth	
WSPD3B10B	WSPD3N10B	HEG	100	29.19	13.38	7.91	WSPD-B = Breaker WSPD-N = No breaker
WSPD3B20B	WSPD3N20B	HEG	200	29.19	13.38	7.91	
WSPD3B30B	WSPD3N30B	HEG	300	29.19	13.38	7.91	
WSPD3B40B	WSPD3N40B	HEG	400	29.19	13.38	7.91	
WSPD3B50B	WSPD3N50B	HEG	500	29.19	13.38	7.91	

3-phase, 4-wire SN, Wye 208/120V AC

Catalog No. (with HEG Breaker Disconnect)	Catalog No. (no disconnect)	Breaker Type	kA Surge Current ^②	Dimensions (inches) ^①			Knockout Diagram
				Height	Width	Depth	
WSPD3B10C	WSPD3N10C	HEG	100	29.19	13.38	7.91	WSPD-B = Breaker WSPD-N = No breaker
WSPD3B20C	WSPD3N20C	HEG	200	29.19	13.38	7.91	
WSPD3B30C	WSPD3N30C	HEG	300	29.19	13.38	7.91	
WSPD3B40C	WSPD3N40C	HEG	400	29.19	13.38	7.91	
WSPD3B50C	WSPD3N50C	HEG	500	29.19	13.38	7.91	

① Dimensions shown are representative of outside box dimensions and do not include allowances for mounting

bumps, endwalls, covers, hubs, or hardware protrusions. Dimensions are subject to change.

② 200 - 500kA devices require additional lead time. Please contact sales office for details on lead time.

Power Mod

Type WMN ConEd Residential Meter Stacks

WMN ConEd Residential Meter Stacks

Siemens Consolidated Edison Residential Meter Stacks are packed with features inside and out; our exclusive knock out plate offers flexibility when pulling wires to the stack, moveable neutrals and grounds to save wire, and all of the QuickSystem features all designed with the contractor in mind. Features 10" socket center-to-center distance to allow use of meter pulling tools.

Surge Protection Module quick reference

- 2-6 gang
- 125/225 Amp per position
- 1200Amp thru-bus rating
- UL standard 67
- UL file no. E27100
- AIC rating: (65k and 100K)
- Voltage
 - 3 phase in single phase out
 - 240V AC max
- All swing latches and rivets are stainless steel
- Outdoor = NEMA 3R rated
- Indoor = NEMA 1R rated
- G90 galvanized steel
- ANSI 61 paint

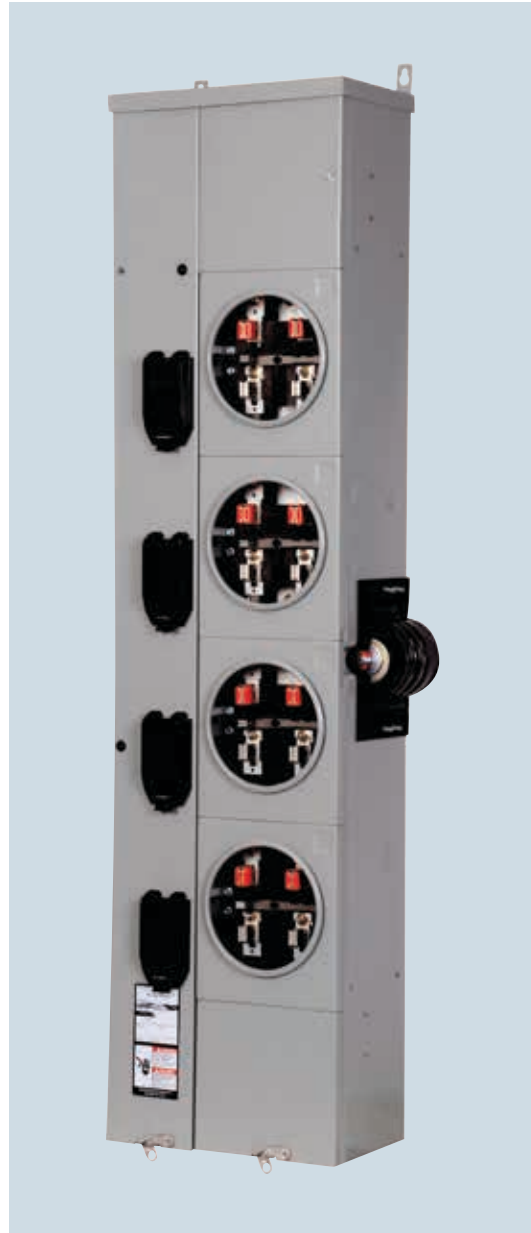

Power Mod

Type WMN ConEd Residential Meter Stacks

Main Features:

- 2-6 gang
- 1200 amp thru-bus
- Suitable for 65k and 100k AIC applications



Residential 5-jaw ring type meter stacks; 3-phase, 4-wire SN, incoming and 1-phase, 3 wire SN outgoing^③

Outdoor Catalog No.	Indoor Catalog No.	Meter Positions Per Stack	Breaker Provision	Maximum AIC ^④	Dimensions (inches) ^①			Knockout Diagram
					Height	Width	Depth	
Max. tenant breaker (Amps): 125								
WMN22125J	MN22125J	2	QP, QPH, HQP, MP-T, MP-HT, MPMT	65k	35.31	12.97	8.09	WMN-1
WMN32125J	MN32125J	3		65k	46.31	12.97	8.09	WMN-2
WMN42125J	MN42125J	4		65k	56.31	12.97	8.09	WMN-3
WMN52125J	MN52125J	5		65k	66.31	12.97	8.09	WMN-4
WMN62125J	MN62125J	6		65k	76.31	12.97	8.09	WMN-5
Max. tenant breaker (Amps): 225^{②③}								
WMN22225J	MN22225J	2	QS, QSH, QSHH, HQS, HQSH, QP, QPH, HQP, MP-T, MP-HT, MPMT	100k	35.31	16.09	8.09	WMN-6
WMN32225J	MN32225J	3		100k	46.31	16.09	8.09	WMN-7
WMN42225J	MN42225J	4		100k	56.31	16.09	8.09	WMN-8
WMN52225J	MN52225J	5		100k	66.31	16.09	8.09	WMN-9
WMN62225J	MN62225J	6		100k	76.31	16.09	8.09	WMN-10

① Dimensions shown are representative of outside box dimensions and do not include allowances for mounting bumps, endwalls, covers, hubs, or hardware protrusions. Dimensions are subject to change.

② 225A available in lower three positions only. 200A continuous for all other positions.

③ Must use QuickPhase features to route all sockets AWAY from high-leg when 240/120 Delta voltage is used.

④ Max AIC determined by maximum AIC of tenant breakers.

⑤ Install QP breakers below QS.

Power Mod

Type WTBN ConEd Tap boxes

Type WTBN ConEd Tap boxes

ConEd Tap Boxes (type WTBN) are designed to meet the requirements of the Consolidated Edison Utility service area. WTBN tap boxes feature a shallow depth for front and rear alignment with WMN stacks.

ConEd Tap boxes

- 400-1200A
- 1200Amp thru-bus rating
- UL standard # UL67
- UL file no. E27100
- AIC rating: (100K AIC)
- Voltage
 - 3 phase in single phase out
 - 240V AC max
- All swing latches and rivets are stainless steel
- NEMA 3R rated
- G90 galvanized steel
- ANSI 61 paint

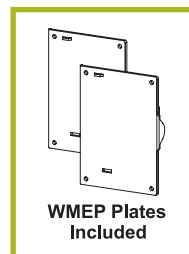

Power Mod





Type WTBN ConEd Tap boxes

Main Features:

- 400-1200A
- 1200 amp thru-bus
- Suitable for 100k AIC applications



Tap Box modules: 3-phase, 4 wire SN, 208/120V AC Max

Catalog No. (100k AC)	Catalog No. (100k AC) Blank Endwall	Ampere Rating	Service Feed [®]	Dimensions (inches) ^①			Line Side Connections (Lugs)	Knockout Diagram
				Height	Width	Depth		
WTBN3400CU	WTBN3400CUNH	400	OH/UG	48.81	17.63	8.063	1 Set Of 2 Studs 	WTBN-1
WTBN3600CU	WTBN3600CUNH	600	OH/UG	48.81	17.63	8.063	1 Set Of 2 Studs 	WTBN-2
WTBN3800CU	WTBN3800CUNH	800	OH/UG	52.84	25.63	8.094	2 Sets Of 2 Studs 	WTBN-3
WTBN31200CU	WTBN31200CUNH	1200	OH/UG	64.47	25.63	8.094	2 Sets Of 2 Studs 	WTBN-4

^① Dimensions shown are representative of outside box dimensions and do not include allowances for mounting

bumps, endwalls, covers, hubs, or hardware protrusions. Dimensions are subject to change.

[®] Devices have studs on top and bottom, but only one side should be used.

Power Mod



WMMB Aux Pull Box

Main Features:



- EUSERC compliant incoming pull section
- Dual cover handles
- Single and three phase models



EUSERC compliant pullbox modules: 1-phase, 3-wire SN, incoming , 120/240V AC max. ③

Catalog No.	Ampere Rating	Withstand Rating ^②	Service Feed	Dimensions (inches) ^①			KO Drawing No.	Line Terminal Lugs No. And Size Per Line And Neutral	Knockout Diagrams
				Height	Width	Depth			
WMMB1400	400	65,000	UG	37.50	16.69	9.34	P-1	1 set of 2 studs 	P-1
WMMB1800	800	65,000	UG	45.50	19.44	12.72	P-2	1 set of 2 studs 	P-2
WMMB11200	1200	65,000	UG	47.50	25.94	12.72	P-3	3 sets of 2 studs 	P-3

EUSERC compliant pullbox modules: 3-phase, 4-wire SN, incoming, 240V AC max. ③

Catalog No.	Ampere Rating	Withstand Rating ^②	Service Feed	Dimensions (inches) ^①			KO Drawing no.	Line Terminal Lugs No. And Size Per Line And Neutral	Knockout Diagrams
				Height	Width	Depth			
WMMB3400	400	65,000	UG	37.50	16.69	9.34	P-1	1 set of 2 studs 	P-1
WMMB3800	800	65,000	UG	45.50	25.94	12.72	P-2	2 set of 2 studs 	P-2
WMMB31200	1200	65,000	UG	47.50	33.83	12.72	P-3	3 sets of 2 studs 	P-3

① Dimensions shown are representative of outside box dimensions and do not include allowances for mounting bumps, endwalls, covers, hubs, or hardware protrusions. Dimensions are subject to change.

② Devices rated for 22,000. 65,000 rating requires cables to be tied together. Please see instructions with pullbox for details.

③ Devices do not have thru bus.

Power Mod

Custom Options, Elbows and Spacers

Custom Options, Elbows and Spacers

Siemens offers a wide range of auxiliary modules and custom options to help product fit your application. All units come with appropriate hardware and instruction sheets for safe installation.

Meet local requirements and save on labor with custom factory installed options and custom paint colors.

Custom colors



- Desert tan
- Forest Green
- Custom Match Options



Power Mod

Custom Options, Elbows, and Spacers

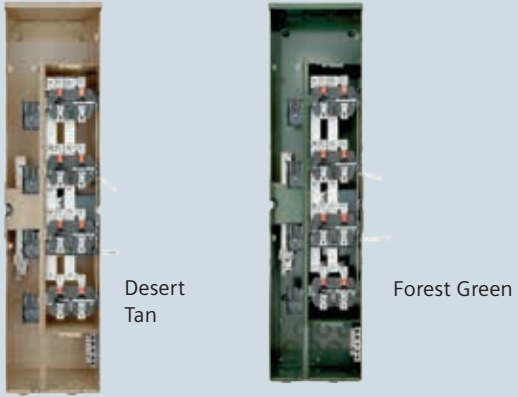
Custom options

	<p>Description</p> <p>Power Mod offers custom options exclusive to the industry. Avoid time consuming field modifications and realize labor savings through factory installed options. Meet local aesthetic requirements with custom color paint options. Eliminate the need to repaint enclosures and risk splattering paint on bus or meter socket components^①:</p> <p>Custom colors:</p> <ul style="list-style-type: none"> ■ Desert tan ■ Forest Green ■ Color match available upon request <p style="text-align: right;">Configure in COMPAS</p> 
---	--

^① Contact sales office for ordering instructions and lead time

Bussed Elbow and Bussed Extensions/Spacers

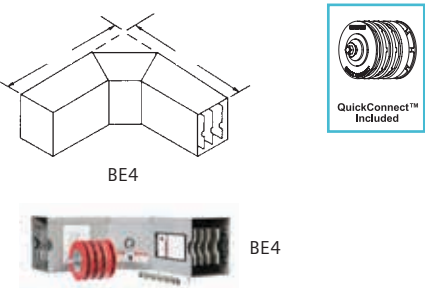
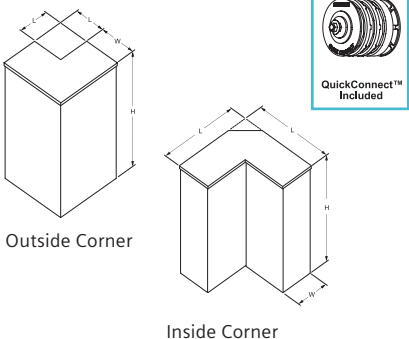
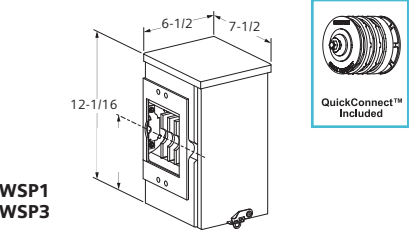
		Catalog No.	Description	Dimensions (inches) ^①		
				Height	Length	Width
NEMA 1 Elbows		BE1^②	Indoor Bussed Elbow, 15", 1-phase, 3-wire, 1200 Amp maximum	5.62	15.06	4.87
		BE4^②	Indoor Bussed Elbow, 15", 3-phase, 4-wire, 1200 Amp maximum	5.62	15.06	4.87
		BE112^②	Indoor Bussed Elbow, 12", 1-phase, 3-wire, 1200 Amp maximum	5.62	12.09	4.87
		BE412^②	Indoor Bussed Elbow, 12", 3-phase, 4-wire, 1200 Amp maximum	5.62	12.09	4.87
NEMA 3R Elbows		WELB318	Outdoor Elbow, Inside corner, 3-phase, 100k max AIC	30.06	18.31	7.97
		WELB118	Outdoor Elbow, Inside corner, 1-Phase, 100k max AIC	30.06	18.31	7.97
		WELB312	Outdoor Elbow, Inside corner, 3-phase, 100k max AIC	30.06	12.31	7.97
		WELB112	Outdoor Elbow, Inside corner, 1-Phase, 100k max AIC	30.06	12.31	7.97
		WELB307E	Outdoor Elbow, Outside corner, 3-phase, 100k max AIC	30.06	6.80	7.97
		WELB107E	Outdoor Elbow, Outside corner, 1-Phase, 100k max AIC	30.06	6.80	7.97
Bussed Extensions/ Spacers		WSP1	Outdoor Bussed Extension, 1-phase, 3-wire, 1200 Amp maximum	12.06	7.25	6.50
		WSP3	Outdoor Bussed Extension, 3-phase, 4-wire, 1200 Amp maximum	12.06	7.25	6.50

^① Dimensions shown are representative of outside box dimensions and do not include allowances for mounting bumps, endwalls, covers, hubs, or hardware protrusions. Dimensions are subject to change.

^② Do not connect indoor elbows directly to busway.

Uni-PAK

Uni-PAK Metering: Introduction

General Information

Siemens Uni-PAK Metering offers maximum flexibility and ease of installation to meet the service requirements of multiple position metering projects. The outdoor/indoor devices are available in two through six gang set-ups which consist of a pull section with main lugs or stud terminations, and 4/5 jaw meter sockets with tenant circuit breaker provisions.

Features include:

- Siemens exclusive 200 ampere/position feature the QS breaker for faster & easier installation
- Removable knock-out plate for back exit
- Mounting rail for wall hanging - Siemens Exclusive
- UL Listed for use with 60/75C degree wire
- Outdoor/indoor construction
- Overhead or underground service; load top, bottom or back

Standard Uni-Pak Quick Reference

- ANSI - Standard #C 12.7-1987
- NEMA - Standard #250-1985
- UL - File #E27100
- UL - Standard #50, 67,414
- Voltage 240V AC Maximum
- 125 amp or 200 amp Maximum per position
- 1000 Amps maximum bus
- 2-6 positions

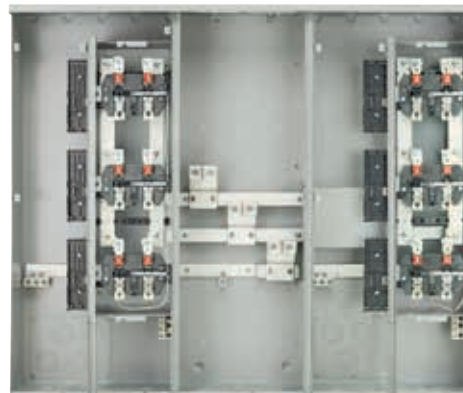

Uni-PAK

Uni-PAK Metering: Introduction

Uni-PAK Construction



Sturdy Steel Base Pan
Provides reinforcing durable support for each tenant main breaker.



2 Pole up to 225A @100kAIC
Fits in 2 inch – compact width reduces enclosure size limiting total mounting space required.



Barrel Lock Capable Covers
Accepts common utility barrel locks to protect against unauthorized usage.



Lockable Breaker Cover



Handle
available on larger devices to make lifting the unit easier.

Line Lugs Factory Installed (WP, WEP, WPC)

Top And Bottom Exit

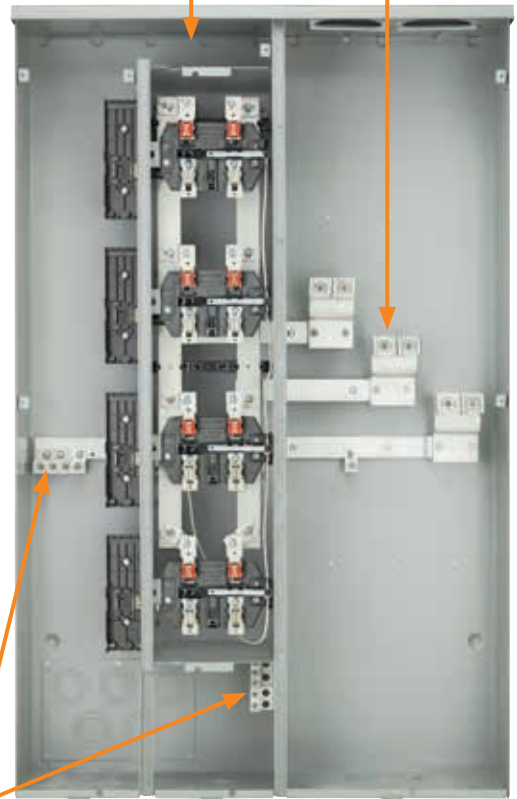

1 Extra Neutral And Ground Termination

Uni-PAK Features and Benefits

Mounting Rail

Simplified mounting by using a separate rail to hang the device.

5Th Jaw Option

Located in 6 or 9 o'clock position. Factory or field installed

Horn Bypass Option

Factory or field installed.

Front Accessible Connections

All connections use similar hardware and use belleville washers for tight connections.

Ring Or Ringless Covers

Individual ring or ringless type meter covers. Ring to ringless kits available to make last minute cover changes for specified utility requirements.

Apartment No. Emboss

Provides convenience and organization.

Removable Back End KO Plate

Simplifies and speeds up pulling wire. Entire plate can be removed to allow ample space for wire. Knockouts in the plate can be removed before or after stack installation.

More Features

- 1) Large range of ampacities 200- 1000A
- 2) 125 amp continuous duty sockets feed plug-in tenant breakers through 125 Amps
- 3) 200 amp continuous duty sockets feed plug-in tenant breakers through 225 Amps
- 4) UL Listed for short circuit ratings up to 100,000 RMS symmetrical Amps at 240V AC
- 5) Lever Bypass models available
- 6) EUSERC compliant models available
- 7) 2 - 6 number of meter positions
- 8) Outdoor/indoor construction
- 9) Overhead or underground service; load top, bottom or back
- 10) Compact design for ease of handling and installation
- 11) All unmetered bus is barriered and sealable to prevent unauthorized access.
- 12) Electrodeposited paint provides uniform coverage for long-lasting protection and sharp appearance
- 13) Complies with the following industry standards
 - ANSI - Standard # C 12.7-1987
 - NEMA - Standard #250-1985
 - UL - File #E10703
 - UL - Standard#50, 67, 414

Rain Channel

Rotates out of the way for easy KO access



Uni-PAK

Uni-PAK Metering: WP Ring Style

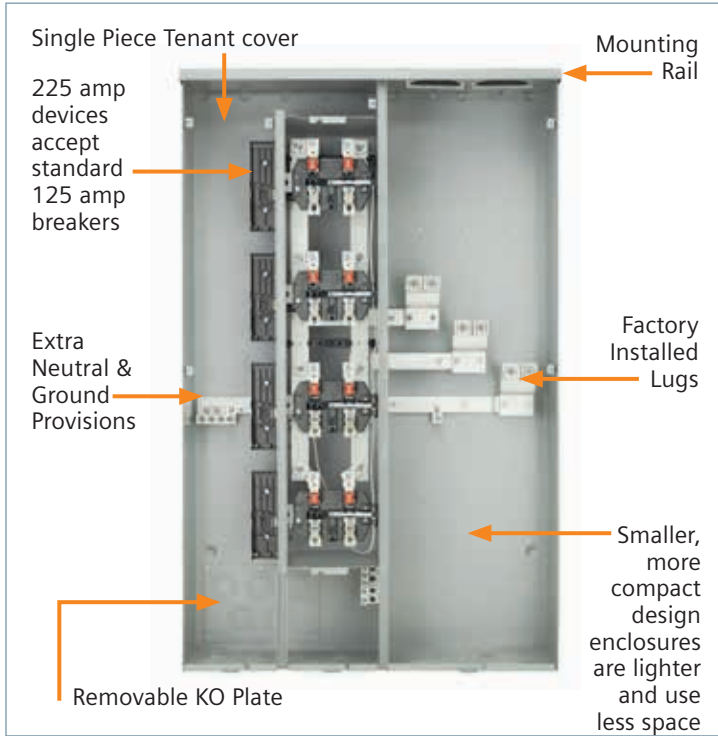

Features

- Individual split covers
- Ring style meter construction
- UL Listed for 60 / 75°C conductors. See equipment markings for applications
- For small apartment buildings, small professional and commercial buildings
- Completely self-contained meter centers
- Two to six 125A and 225A sockets breaker positions
- Outdoor surface mounted enclosures
- Compact, pre-bussed, easy to handle, hang and wire
- Barrired, sealable compartment for unmetered current-carrying parts
- Al/Cu lay-in lugs, except two position 125A units
- Top or bottom feed
- Bottom and rear branch wiring exits (Neutral and ground at bottom only)
- ANSI #61 light gray electrodeposited paint on G90 galvanized steel
- Field installable 5th jaw kit

Ring Style Uni-PAK 120/240V 1 Phase, 3 Wire

Maximum Tenant Main	Bus Amperage	Meter Positions Per Pak	Catalog No.	Breaker Provision	Max. AIC	Dimensions ^①			5th Jaw Assembly	Line Lugs Wire Range
						Height	Width	Depth		
125	200	2	WP2211	QP, QPH, HQP, MP-T, MP-HT, MP-MT	65,000	26.26	13.80	5.81	ECMF5 6:00 or 9:00	#6-300 kcmil
		3	WP3311			38.75				#2-600 kcmil
	400	4	WP4411			47.75	25.42	1/0-750 kcmil CU-AL or (2) 1/0-250 AL or (2) 1/0-3/0 CU		
		5	WP4511			38.75	38.95	(2) #2-600 kcmil		
	500	4	WP5411			47.75	26.47			
		600	5			WP5511	38.75	39.01		
6	WP6611		38.75	40.01						
225	400	2	WP4212	QP, QPH, HQP, MP-T, MP-HT, MP-MT, QS, QSH, QSHH, HQS, HQSH	100,000	29.75	28.53	7.56	ECMF5 6:00 or 9:00	1/0-750 kcmil CU-AL or (2) 1/0-250 AL or (2) 1/0-3/0 CU
		3	WP4312			38.75				(2) #2-600 kcmil
		4	WP4412			47.75				29.59
	600	5	WP6512			38.75	46.22			(2) 1/0-750 kcmil or (4) 1/0-250 AL or (4) 1/0-3/0 CU
		6	WP6612				51.03			(3) #2-500 kcmil
	800	6	WP8612							
1000	6	WP10612								

Uni-PAK Alternate Lug Kits (WP ONLY) ^②	
WPLK2400	400A Bus Lug Kit (2) #4-250
WPLK2600	600A Bus Lug Kit (3) #6-250

^① Dimensions shown are representative of outside box dimensions and do not include allowances for mounting bumps, endwalls, covers, hubs, or hardware protrusions. Dimensions are subject to change.
^② Designed for Georgia Power. Not limited thereto.

Uni-PAK

Uni-PAK Metering: WP Ringless Style, No Bypass

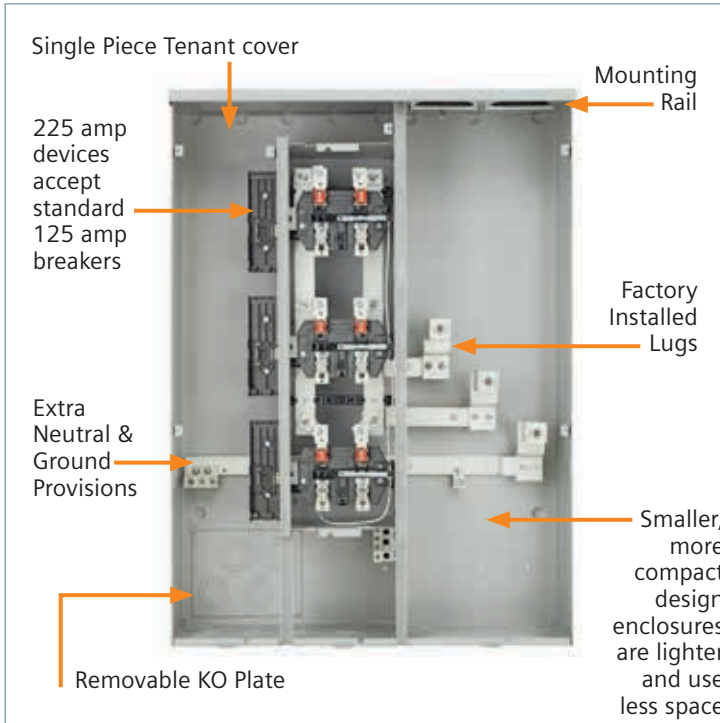

Features

- Ringless meter construction
- Individual split covers with barrel lock compatibility
- Available with horn bypass factory installed
- UL Listed for 60/75°C conductors See equipment markings for applications
- For small apartment buildings, small professional and commercial buildings
- Completely self-contained meter centers
- Two to six 125A and 225A breaker positions
- Compact, pre-bussed, easy to handle, hang and wire
- Barrired, sealable compartment for unmetered current-carrying parts
- Al/Cu lay-in lugs, except two position 125A units
- Top or bottom feed
- Bottom and rear branch wiring exits (Neutral and ground at bottom only)
- ANSI #61 light gray electrodeposited paint on G90 galvanized steel
- 5th jaw kit included with each unit
- Outdoor surface mounted enclosures

Ringless Style Uni-PAK 120/240V 1 Phase, 3 Wire

Max. Tenant Main	Bus Amperage	Meter Positions Per Pak	Catalog No.	Breaker Provision	Max. AIC	Dimensions ^①			5th Jaw Assembly	Horn Bypass Kit	Line Lugs Wire Range
						Height	Width	Depth			

No Bypass

125	200	2	WP2211RJ	QP, QPH, HQP, MP-T, MP-HT, MP-MT	65,000	26.26	13.80	5.81	INCL. 9:00 factory 6:00 field	ECMFH	#6-300 kcmil
	300	3	WP3311RJ			38.75	25.42	#2-600 kcmil			
	400	4	WP4411RJ			47.75	38.95	1/0-750 kcmil CU-AL or (2) 1/0-250 AL or (2) 1/0-3/0 CU			
		6	WP4611RJ			38.75					
	500	4	WP5411RJ			47.75	26.47	(2) #2-600 kcmil			
	600	5	WP6511RJ			38.75	39.01				
		6	WP6611RJ		40.01						
225	400	2	WP4212RJ	QP, QPH, HQP, MP-T, MP-HT, MP-MT, QS, QSH, QSHH, HQS, HQSH	100,000	29.75	28.53	7.56	INCL. 9:00 factory 6:00 field	ECMFH	1/0-750 kcmil CU-AL or (2) 1/0-250 AL or (2) 1/0-3/0 CU
		3	WP4312RJ			38.75					
	600	4	WP4412RJ			47.75	29.59				(2) #2-600 kcmil
		5	WP6512RJ			38.75	46.22				
			6								WP6612RJ
	800					WP8612RJ					51.03
1000			WP10612RJ			(3) #2-500 kcmil					

Uni-PAK Alternate Lug Kits (WP ONLY) ^②	
WPLK2400	400A Bus Lug Kit (2) #4-250
WPLK2600	600A Bus Lug Kit (3) #6-250

^① Dimensions shown are representative of outside box dimensions and do not include allowances for mounting bumps, endwalls, covers, hubs, or hardware protrusions. Dimensions are subject to change.

^② Designed for Georgia Power. Not limited thereto.

Uni-PAK

Uni-PAK Metering: WP Ringless Style, Horn Bypass

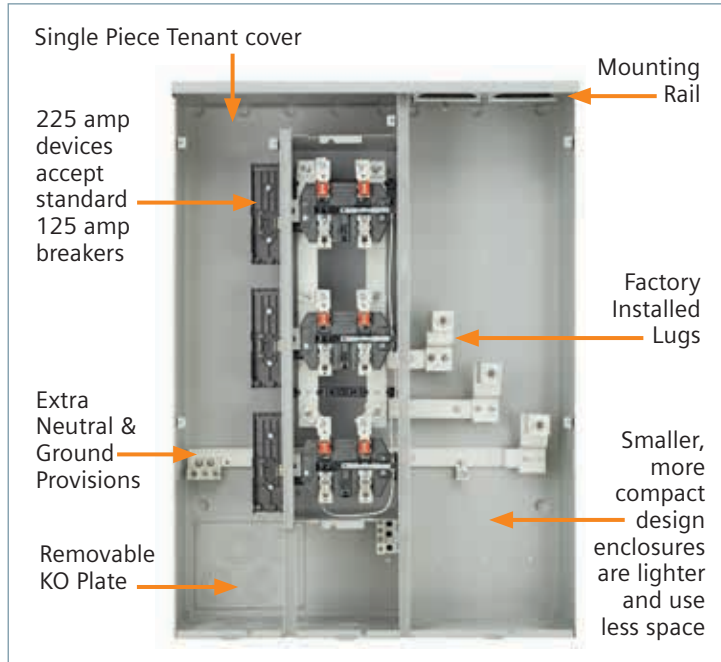

Features

- Ringless meter construction
- Individual split covers with barrel lock compatibility
- Horn bypass factory installed
- UL Listed for 60/75°C conductors See equipment markings for applications
- For small apartment buildings, small professional and commercial buildings
- Completely self-contained meter centers
- Two to six 125A and 225A breaker positions
- Barriercd, sealable compartment for unmeterecd current-carrying parts
- Al/Cu lay-in lugs, except two position 125A units
- Top or bottom feed
- Bottom and rear branch wiring exits (Neutral and ground at bottom only)
- ANSI #61 light gray electrodeposited paint on G90 galvanized steel
- 5th jaw kit included with each unit
- Outdoor surface mounted enclosures

Ringless Style Uni-PAK 120/240V 1 Phase, 3 Wire

Max. Tenant Main	Bus Amperage	Meter Positions Per Pak	Catalog Number	Breaker Provision	Max. AIC	Dimensions ^①			5th Jaw Assembly	Line Lugs Wire Range
						Height	Width	Depth		

Horn Bypass

125	200	2	WP2211RJB	QP, QPH, HQP, MP-T, MP-HT, MP-MT	65,000	26.26	13.80	5.81	INCL. 9:00 factory 6:00 field	#6-300 kcmil
	300	3	WP3311RJB			38.75				25.42
	400	4	WP4411RJB			47.75	38.95			1/0-750 kcmil CU-AL or (2) 1/0-250 AL or (2) 1/0-3/0 CU
		5	WP4511RJB			38.75				26.47
	500	4	WP5411RJB			47.75	38.75			
	600	5	WP6511RJB			38.75	28.53			29.59
	6	WP6611RJB	47.75	29.59	(2) #2-600 kcmil					
225	400	2	WP4212RJB	QP, QPH, HQP, MP-T, MP-HT, MP-MT, QS, QSH, QSHH, HQS, HQSH	100,000	29.75	28.53	7.56	INCL. 9:00 factory 6:00 field	1/0-750 kcmil CU-AL or (2) 1/0-250 AL or (2) 1/0-3/0 CU
		3	WP4312RJB			38.75				29.59
	600	4	WP4412RJB			46.22	51.03			(2) 1/0-750 kcmil or (4) 1/0-250 AL or (4) 1/0-3/0 CU
		5	WP6512RJB							
	600	6	WP6612RJB			46.22	51.03			(2) #2-600 kcmil
	800	6	WP8612RJB			38.75	51.03			(2) 1/0-750 kcmil or (4) 1/0-250 AL or (4) 1/0-3/0 CU
1000	6	WP10612RJB	38.75	51.03	(3) #2-500 kcmil					

Horn Bypass, Alternate Enclosure Size and Lug Configuration^③

125	200	2	WPC2211RJB	QP, QPH, HQP, MP-T, MP-HT, MP-MT	65,000	32.53	13.80	5.81	INCL. 9:00 factory 6:00 field	#6-300 kcmil
225	400	2	WPC4212RJB	QP, QPH, HQP, MP-T, MP-HT, MP-MT, QS, QSH, QSHH, HQS, HQSH	100,000	29.75	28.53	7.56		#6-350 kcmil
225	400	3	WPC4312RJB	QP, QPH, HQP, MP-T, MP-HT, MP-MT, QS, QSH, QSHH, HQS, HQSH	100,000	38.75				

Uni-PAK Alternate Lug Kits (WP ONLY) ^②	
WPLK2400	400A Bus Lug Kit (2) #4-250
WPLK2600	600A Bus Lug Kit (3) #6-250

① Dimensions shown are representative of outside box dimensions and do not include allowances for mounting bumps, endwalls, covers, hubs, or hardware protrusions. Dimensions are subject to change.

② Designed for Georgia Power. Not limited thereto.
③ Approved for use with Alliant Energy. Not limited thereto.

Uni-PAK

Uni-PAK Metering: WEP Ringstyle EUSERC

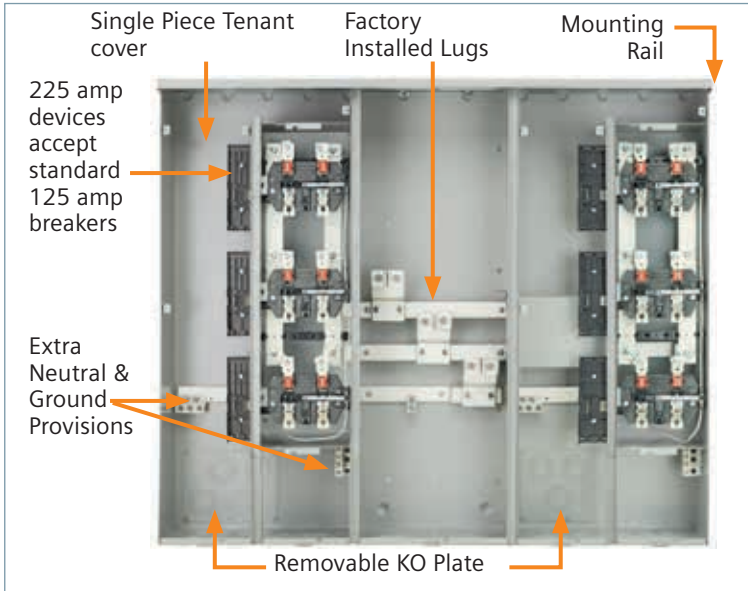

Features

- Individual split covers
- UL Listed for 60 / 75°C conductors. See equipment markings for applications
- Completely self-contained meter centers
- Outdoor surface mounted enclosures
- Semi flush with applicable field installed kit
- Barriercd, sealable compartment for unmetered current-carrying parts
- Al/Cu lay-in lugs, except two socket units
- Top or bottom feed
- Bottom and rear branch wiring exits (Neutral and ground at bottom only)
- Meets EUSERC specifications when NEMA stud kit and flushing ring (if required) is field added. Compression lugs, if required, are sold separately.

EUSERC Compliant Ring Style Uni-PAK 120/240V 1 Phase, 3 Wire

Max. Tenant Main	Bus Amperage	Meter Positions Per Pak	Catalog No.	Breaker Provision	Max. AIC	Dimensions ^①			5th Jaw Assembly	Line Lugs Wire Range	Semi-Flush Kit #	EUSERC Drawing #342 ^②
						Height	Width	Depth				
125	200	2	WEP2211	QP, QPH, HQP, MP-T, MP-HT, MP-MT	65,000	32.52	13.80	7.56	ECMF5 6:00 or 9:00	#6-300 kcmil	WPFK1	figure 1
	300	3	WEP3311			38.75	25.42			#2-600 kcmil	WPFK2	
	400	4	WEP4411			47.75	38.94			1/0-750 kcmil CU-AL or (2) 1/0-250 AL or (2) 1/0-3/0 CU	WPFK3	
		5	WEP4511			38.75	31.28			(2) #2-600 kcmil	WPFK4	
	500	4	WP5411			47.75	44.82				WPFK5	
	600	5	WEP6511			38.75	28.53			1/0-750 kcmil CU-AL or (2) 1/0-250 AL or (2) 1/0-3/0 CU	WPFK6	
6	6	WEP6611	47.75	34.41	(2) #2-600 kcmil	WPFK7						
225	400	2	WEP4212	QP, QPH, HQP, MP-T, MP-HT, MP-MT, QS, QSH, QSHH, HQS, HQSH	100,000	29.75	28.53	7.56	ECMF5 6:00 or 9:00	1/0-750 kcmil CU-AL or (2) 1/0-250 AL or (2) 1/0-3/0 CU	WPFK8	figure 2
		3	WEP4312			38.75				34.41	WPFK9	
		4	WEP6412			47.75				51.04	WPFK10	
	600	5	WEP6512			38.75	51.04			(2) #2-600 kcmil	WPFK11	
		6	WEP6612							(2) 1/0-750 kcmil or (4) 1/0-250 AL or (4) 1/0-3/0 CU		
	800	6	WEP8612 ^②			57.53	(3) #2-500 kcmil			N/A		
1000			WEP10612 ^②									

EUSERC Dual-amp Uni-PAK for EV Car Charger^{③④}

Max. Tenant Main	Bus Amperage	Meter Positions Per Pak	Catalog No.	Breaker Provision	Max. AIC	Dimensions ^①			5th Jaw Assembly	Line Lugs Wire Range
						Height	Width	Depth		
Position 1: 50A Position 2: 200A	200A	2	WEP2212EV	QP, QPH, HQP, QS, QSH, QSHH, HQS, HQSH	65,000	32.47	16.25	6.03	ECMF5	300 kcmil - #4 AWG

NEMA Stud Kits (WEP Only)^⑤

Catalog No.	Amperage	Note
WPSK400	400A	fits 300-400
WPSK600	600A	fits 500-600
WPSK800	800A	—
WPSK1000	1000A	—

① Dimensions shown are representative of outside box dimensions and do not include allowances for mounting bumps, endwalls, covers, hubs, or hardware protrusions. Dimensions are subject to change.

② Please note the EUSERC standard currently only covers up to 600 amp devices. Please consult utility prior to installation.

③ Applies to EUSERC drawing #342.

④ Uni-PAK designed for EV car charger. Has separate meter for utility company to offer lower rate for power to EV charger (50A top position).

⑤ To be used with compression or mechanical lugs. Power Mod type LK_N2(E) lug kits can be used. View cutsheet for specific lug kit options.

Uni-PAK

Uni-PAK Metering: WPL Ringless Style, Lever Bypass

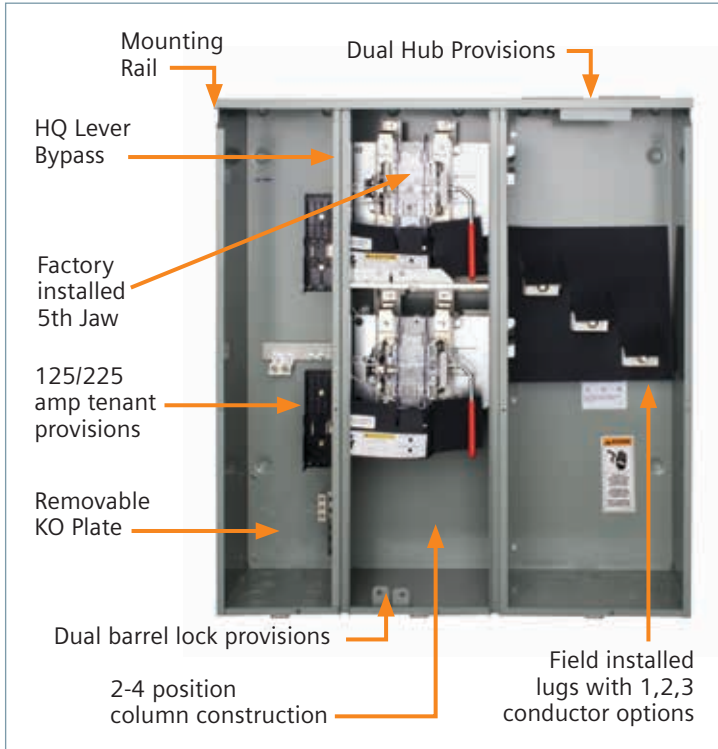

Features:

- Side mounted handles to help in lifting
- Provisions for one, two, or three incoming conductors per phase and neutral (lugs field installed)
- 225 amp branch tenant provisions @ 100,000 AIC
- Full line of 2-6 position devices
- Light and compact design
- Individual split cover
- UL Listed for 60/75 degrees C conductors. See equipment markings for applications
- For small apartment buildings, small professional and commercial buildings
- Completely self-contained meter centers
- Outdoor surface mounted enclosures
- Barriercd, sealable compartment for unmetered current-carrying parts
- Top or bottom fed
- Bottom and rear branch wiring exits (Neutral and ground at bottom only)
- ANSI #61 light gray electrodeposited paint on G90 galvanized steel.

Ringless Style Uni-PAK 120/240V 1 Phase, 3 Wire, Lever Bypass

Max. Tenant Main	Bus Amperage	Meter Positions Per Pak	Catalog No.	Breaker Provision	Max. AIC	Dimensions ^①			5th Jaw Assembly	Line Lugs Wire Range
						Height	Width	Depth		
225	400	2	WPL4212RJ	QP, QPH, HQP, MP-T, MP-HT, MP-MT, QS, QSH, QSHH, HQS, HQSH	100,000	36.88	33.72	9.84	INCL. 9:00 position	3/8" Stud – Field installed lugs ^②
		3	WPL4312RJ			49.88				
		4	WPL4412RJ WPL6412RJ			62.88				
	600	5	WPL6512RJ			49.75	53.56			
		6	WPL6612RJ							
			WPL8612RJ							
			WPL10612RJ							
800										
1000										

Lug Kits (WPL only)^②

Catalog Number	Wire Range
H56476	3/0-800 kcmil
H60162	(2) 1/0-250 kcmil OR (1) #4-600 kcmil
H68752-1	(3) #6-250 kcmil
H56732	(2) #4-350 kcmil
H56732-M	(2) #4-500 kcmil

^① Dimensions shown are representative of outside box dimensions and do not include allowances for mounting bumps, endwalls, covers, hubs, or hardware protrusions. Dimensions are subject to change.

^② Lug kits should be chosen based on the wire size being run to the unit. Wire should be sized according to the National Electrical Code. Lugs are sold separately. On 400-600A applications, a total of 3 lugs are required to wire the line side of the device. Lugs sold in packs of 2 pieces.

Lugs, breakers and other accessories

Siemens offers a wide range of accessories to help your product fit the application. Eliminate the need for special orders with replacement part kits available for your convenience. All kits come with appropriate hardware and instruction sheets for installation.

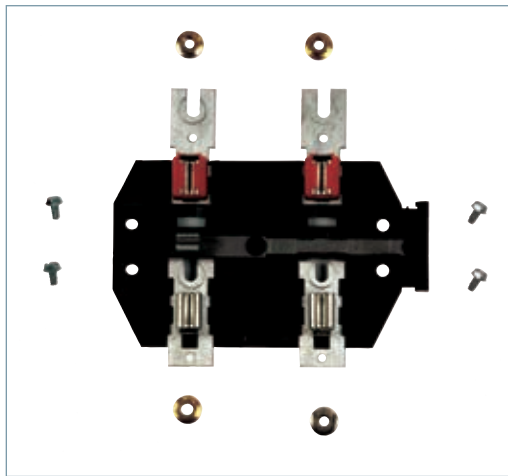

Power Mod

Modular Metering Lug Kits

Power Mod: Modular Metering Lug Kits

Lug Kits Quick Reference
<ul style="list-style-type: none"> ■ UL 486 A/B ■ Tin-plated aluminium

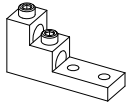
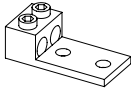
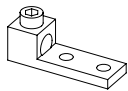
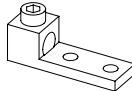
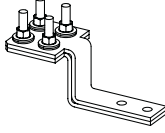
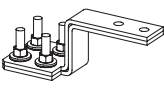
Lug Kit Contents					
Wire Range: 1/0-750 kcmil	Wire Range: #6-350 kcmil	Wire Range: #2-600 kcmil	Wire Range: 300-800 kcmil	Upward Bus Extension	Downward Bus Extension
					
Wire Binding Screw Torque: 500 lb.-in.	Wire Binding Screw Torque: 275 lb.-in.	Wire Binding Screw Torque: 500 lb.-in.	Wire Binding Screw Torque: 500 lb.-in.	Wire Binding Screw Torque: 500 lb.-in.	Wire Binding Screw Torque: 500 lb.-in.

Lug Kit Catalog No.	Wire Range	Lug Quantity	Lug Quantity	Lug Quantity	Lug Quantity	Unit Quantity	Unit Quantity
LK12350N2	#6-350 kcmil		3				
LK32350N2	#6-350 kcmil		4				
LK12500N2	1/0-500 kcmil	3					
LK32500N2	1/0-500 kcmil	4					
LK12500N2E	#2-500 kcmil			6			
LK32500N2E	#2-500 kcmil			8			
LK13500N2	1/0-500 kcmil	3		3			
LK33500N2	1/0-500 kcmil	4		4			
LK14500N2	1/0-500 kcmil	6					
LK34500N2	1/0-500 kcmil	8					
LK14500N2E	1/0-500 kcmil	3		6			
LK34500N2E	1/0-500 kcmil	4		8			
LK15600N2	1/0-600 kcmil	6		3			
LK35600N2	1/0-600 kcmil	8		4			
LK11600N2	#2-600 kcmil			3			
LK31600N2	#2-600 kcmil			4			
LK12600N2	#2-600 kcmil			6			
LK32600N2	#2-600 kcmil			8			
LK11750N2	300-750 kcmil				3		
LK31750N2	300-750 kcmil				4		
LK12750N2	300-750 kcmil				6		
LK32750N2	300-750 kcmil				8		
LK13750N2	300-750 kcmil	3			3		
LK33750N2	300-750 kcmil	4			4		
LK13750N2E	300-750 kcmil				9		
LK33750N2E	300-750 kcmil				12		
LK15750N2	300-750 kcmil	6			3		
LK35750N2	300-750 kcmil	8			4		
LK16750N2	1/0-750 kcmil	9					
LK36750N2	1/0-750 kcmil	12					
LK18500N2C	1/0-500 kcmil CU	12				3	
LK38500N2C	1/0-500 kcmil CU	16				4	
LK18570N2A	1/0-750 kcmil AL	12				3	
LK38570N2A	1/0-750 kcmil AL	16				4	
LK18500N2CD	1/0-500 kcmil CU	12					3
LK38500N2CD	1/0-500 kcmil CU	16					4
LK18570N2AD	1/0-750 kcmil AL	12					3
LK38570N2AD	1/0-750 kcmil AL	16					4

Power Mod

Lug Kits: Lug selector

How to use the Power Mod lug selector:

1. Select enclosure from top
2. Choose applicable wire size
3. Select number of conductors being run beside appropriate amperage and phase to find correct lug kit part number

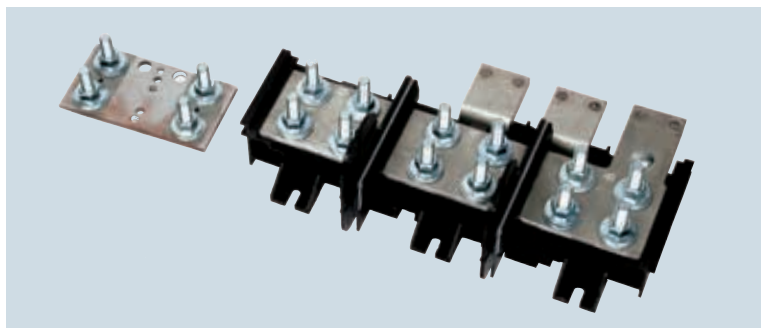

Additional lug combinations may be used. Reference the lug chart on page 2-193 to determine the number of conductors per phase and conductor size as required.

Note that while some connector kits may physically fit, the maximum wire range of the connector may not meet UL required bending space. If a lug kit other than what is on the wiring diagram is used, it is up to the installer to ensure the installation is acceptable.

Power Mod Lug Selector Table

		Type WTB			Type WB			
		Standard tap box			Standard breaker			
Amperage	Conductors	Wire size	500	600	750	500	600	750
1 Phase	200 - 400	1	n/a	LK11600N2	n/a	n/a	n/a	LK11750 ^①
		2	LK12500N2	n/a	n/a	LK12500 ^{①②}	n/a	n/a
	500 - 600	2	n/a	n/a	n/a	LK12500 ^{①②}	n/a	n/a
		2	n/a	LK12600N2	LK12750N2	n/a	n/a	n/a
	700 - 800	3	LK13500N2	n/a	n/a	LK13500 ^{①②}	n/a	LK13750 ^①
		3	n/a	n/a	LK13750N2	n/a	n/a	LK13750 ^①
	900 - 1200	4	LK14500N2	n/a	n/a	LK14500 ^{①②}	n/a	n/a
		5	n/a	LK15600N2	LK15750N2	n/a	LK15600N2	LK15750N2
1400 - 1600	6	n/a	n/a	n/a	n/a	n/a	LK16750N2	
2000	8	LK18500N2C ^③	n/a	LK18750N2A ^③	n/a	n/a	n/a	
3 Phase	200 - 400	1	n/a	LK31600N2	n/a	n/a	n/a	LK31750 ^①
		2	LK32500N2	n/a	n/a	LK32500 ^{①②}	n/a	n/a
	500 - 600	2	n/a	n/a	n/a	LK32500 ^{①②}	n/a	n/a
		2	n/a	LK32600N2	LK32750N2	n/a	n/a	n/a
	700 - 800	3	LK33500N2	n/a	n/a	LK33500 ^{①②}	n/a	LK33750 ^①
		3	n/a	n/a	LK33750N2	n/a	n/a	LK33750 ^①
	900 - 1200	4	LK34500N2	n/a	n/a	LK34500 ^{①②}	n/a	n/a
		5	n/a	LK35600N2	LK35750N2	n/a	LK35600N2	LK35750N2
1400 - 1600	6	n/a	n/a	n/a	n/a	n/a	LK36750N2	
2000	8	LK38500N2C ^③	n/a	LK38750N2A ^③	n/a	n/a	n/a	

① Lug kits - Sentron mechanical breaker lugs
 ② Factory installed lugs

③ Lug landing pad must be ordered in addition to lug kit. Refer to page 94 for lug landing pad options. Not compatible with Skinny Mains.

④ WT tap boxes require 2 lug kits when used on feed thru applications.
 ⑤ Lug kits for 2400A WT and WTB tap boxes only.

Power Mod

Lug Kits: Lug selector

Lug kits are available to meet the growing demand for multiple wiring configurations using aluminum and copper conductors in today's market. Power Mod offers a variety of lug configurations for every breaker, switch, and tap box module. Lugs are factory installed on standard breaker modules 200A-1200A. Alternate lug kits options (including 750kcmil) are available.

A field installable compression lug landing pad is available as an accessory for standard breaker module 250A-1200A. Compression lug kits must be ordered in addition to the lug landing pad accessory. The lug landing pad accessory is not compatible with the skinny mains with dedicated feed directions.

Lug kits must be ordered separately for standard breaker modules 1400A-2000A.

All EUSERC breaker main, standard switch, EUSERC switch, standard tap box, and EUSERC tap box require lugs to be ordered separately and field installed.

Use the chart below to identify the proper lug kit based on the conductor size required.

For example, if you have (1) 1200 single phase tap box, and are running (3) 750 kcmil wires per phase, you would order (1) LK13750N2

Power Mod Lug Selector Table (cont.)

		Type WB + Lug Landing Pad				Type WS			Types WET, WES, WEB, WBT, WT ^④			
Amperage	Conductors	Lug kits for Lug Landing Pad on Standard Breaker Module ^③				Standard fusible switch			Pullbox combination units			
		Wire size	350	500	600	750	500	600	750	500	600	750
1 Phase	200-400	1	n/a	n/a	LK11600N2	n/a	n/a	LK11600N2	LK11750N2	n/a	n/a	LK11750N2
		2	LK12350N2	n/a	n/a	n/a	LK12500N2	n/a	n/a	LK12500N2	n/a	n/a
	500-600	2	LK12350N2	n/a	n/a	n/a	LK12500N2	n/a	n/a	LK12500N2E	n/a	LK12750N2
		2	n/a	n/a	LK12600N2	LK12750N2	n/a	LK12600N2	LK12750N2	n/a	LK12600N2	LK12750N2
	700-800	3	n/a	LK13500N2	n/a	n/a	LK13500N2	n/a	n/a	LK13500N2	n/a	n/a
		3	n/a	n/a	n/a	LK13750N2	n/a	n/a	n/a	n/a	n/a	LK13750N2E
	900-1200	4	n/a	LK14500N2	n/a	n/a	LK14500 ^⑤	n/a	n/a	LK14500N2E	n/a	n/a
		5	n/a	n/a	n/a	n/a	n/a	n/a	n/a	n/a	LK15600N2	LK15750N2
2000	6	n/a	n/a	n/a	n/a	n/a	n/a	n/a	n/a	n/a	n/a	
2400	8	n/a	n/a	n/a	n/a	n/a	n/a	n/a	LK18500N2C ^⑥	n/a	LK18750N2A [®]	
3 Phase	200-400	1	n/a	n/a	LK31600N2	n/a	n/a	LK31600N2	LK31750N2	n/a	n/a	LK31750N2
		2	LK32350N2	n/a	n/a	n/a	LK32500N2	n/a	n/a	LK32500N2	n/a	n/a
	500-600	2	LK32350N2	n/a	n/a	n/a	LK32500N2	n/a	n/a	LK32500N2E	n/a	LK32750N2
		2	n/a	n/a	LK32600N2	LK32750N2	n/a	LK32600N2	LK32750N2	n/a	LK32600N2	LK32750N2
	700-800	3	n/a	LK33500N2	n/a	n/a	LK33500N2	n/a	n/a	LK33500N2	n/a	n/a
		3	n/a	n/a	n/a	LK33750N2	n/a	n/a	n/a	n/a	n/a	LK33750N2E
	900-1200	4	n/a	LK34500N2	n/a	n/a	LK34500 ^⑤	n/a	n/a	LK34500N2E	n/a	n/a
		5	n/a	n/a	n/a	n/a	n/a	n/a	n/a	n/a	LK35600N2	LK35750N2
2000	6	n/a	n/a	n/a	n/a	n/a	n/a	n/a	n/a	n/a	LK36750N2	
2400	8	n/a	n/a	n/a	n/a	n/a	n/a	n/a	LK38500N2C ^⑥	n/a	LK38750N2A [®]	

① Lug kits - Sentron mechanical breaker lugs
 ② Factory installed lugs

③ Lug landing pad must be ordered in addition to lug kit. Refer to page 94 for lug landing pad options. Not compatible with Skinny Mains.

④ WT tap boxes require 2 lug kits when used on feed thru applications.
 ⑤ Lug kits for 2400A WT and WTB tap boxes only.

Power Mod and Uni-PAK

Multifamily Metering Accessories and Replacement Parts

Conduit Hubs

Catalog No.	Description
Type RX	
EC38594	3/4" Conduit Hub
EC38596	1" Conduit Hub
EC38597	1 1/4" Conduit Hub
EC38598	1 1/2" Conduit Hub
EC9747-1113	Adapter plate for HD/RX

Type HD	
EC56854 [®]	2" Conduit Hub
EC56855 [®]	2 1/2" Conduit Hub
EC56856	3" Conduit Hub
EC56857	3 1/2" Conduit Hub
EC56858	4" Conduit Hub
EC56933S	Closure Plate

Accessory	Catalog No.	Description
	QC1	QuickConnect 1-phase, 3-wire, 1200 Amp maximum.
	QC4	QuickConnect 3-phase, 4-wire, 1200 Amp maximum.
	LLP600 [®]	Lug Landing Pad for 200-600 Amp Standard Breaker modules (WB) only.
	LLP1200 [®]	Lug Landing Pad for 800-1200 Amp Standard Breaker modules (WB) only.
	WMMBK [Ⓢ]	Pass-thru bussing - for use with underground pull box (WMMB modules).
	WMEP	Plastic end enclosure plate for thru bussing.
	SRSS	Sealing ring - snap-on, stainless steel.
	SRSW	Sealing ring - screw type, stainless steel.
	SRSTD	Sealing ring - snap on, aluminum (comes standard).
	ECJS [Ⓢ]	Meter bypass jumper 4 AND 5 JAW - not for use with lever bypass. For temporary use ONLY. Only works with ECPP cover. 200A max. Comes with 2 jumpers.
	ECPP	Plastic Ring Style cover plate. May be used with ringless style cover in conjunction with ECJS.
	ECCP3	Plastic Ringless Style cover plate.









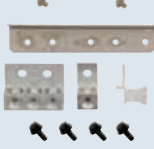

Ⓢ One pass thru bussing supplied with each WMMB device.
 Ⓢ Item is a kit consisting of adapter plate and RX Type Hub

Ⓢ Required per 1-phase meter socket. Residential type ring and ringless - 200 Amp max. Meter cannot be installed while in use. Made for use with ECPP cover plate.

Ⓢ No kits are available for WEP2211.
 Ⓢ Cannot be used for top-feed applications.



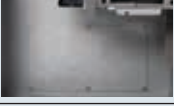









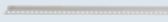

Power Mod and Uni-PAK

Multifamily Metering Accessories and Replacement Parts

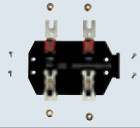
Accessory	Catalog No.	Description
	ECMMRS	Power Mod mini ratchet set Includes: <ul style="list-style-type: none"> ■ 2" T-25 Torx Bit - Eases removal and re-installing of cover screws ■ 5/16" Magnetic Nut Setter - Eases the installation of Tap Boxes when QuickBolt assembly is required to be removed from one side. It can also be used to quickly install or reposition the fifth jaw. ■ 3/8" x 1/4" drive deep well socket - Eases connection of adjacent module using hardware provided.
	ECMFTAB	Mounting tabs or "ears" for top of Power Mod devices. Comes with 2 tabs.
	ECMFGN125	Kit for replacement or additional ground and neutral lugs for 125 Amp (W)MM residential stacks. Can also be used as the replacement or additional ground lug kit for 225 Amp (W)MM residential stacks.
	ECMFN225	Neutral lug kit for 225 Amp Residential stacks (type (W)MM Power Mod only).
	ECMFPK	Power Mod loose parts replacement kit. Includes: instruction sheet, (6) apartment number labels, (6) service disconnect labels, (4) 1/4-20 hex nuts, (4) #10-32 hex nuts, (4) 1/4-20 x 1/2 screws, (4) wing-nuts, (4) #10 flat washers, (4) #10 lock washers.
	ECMFCS	Cover screw replacement (quantity 10) for Power Mod and Uni-PAK devices.
	ECMMBC	Power Mod breaker cover replacement Type 3. Used only on 1200A WES mains, all WMK stacks, 100A 3-ph in/3-ph out (W)ML stacks and 400A (W)ML non-fused stacks.
	ECMMBCM	Power Mod plastic breaker cover for type WB and WEB main breaker units manufactured prior to 4/16/2018.
	ECBC	Breaker cover replacement for type (W)MM, (W)ML, WMT single phase meter stacks and series WP, WEP, WPL, and WPC Uni-PAK.
	ECMMKOP	Power Mod knock-out plate with knock-outs for type (W)MM Residential Stacks (not suitable for Uni-PAK). Attaches to back wall of unit.
	ECMMNKOP	Power Mod knock-out plate without knock-outs for Type (W)MM Residential Stacks (not suitable for Uni-Pak). This is a blank plate, ideal for contractors who want to cut their own holes in the back plate
	ECMLNKOP	Blank removable back plate for 125A (W)ML stacks (not suitable for Uni-PAK).















Power Mod and Uni-PAK

Multifamily Metering Accessories and Replacement Parts

Accessory	Catalog No.	Description
	ECMFWLCLIP	Rail/clip located on back of unit with wheels (Power Mod only).
	MMCLIP	Rail/clip that comes on back of unit, no wheels (Power Mod only).
	MMRAIL	12" Standard wall mounting rail (Power Mod or Uni-PAK).
	MMZR24	24" long mounting "Z" rail for wall mounting (Power Mod or Uni-PAK).
	MMZR36	36" long mounting "Z" rail for wall mounting (Power Mod or Uni-PAK).
	MMZR48	48" long mounting "Z" rail for wall mounting (Power Mod or Uni-PAK).
	MMZR60	60" long mounting "Z" rail for wall mounting (Power Mod or Uni-PAK).
	ECMFH	Horn bypass kit for field replacement or addition on ringless type (W)MM meter stacks and ringless series WP and WPC Uni-PAK.
	ECMF5	5th jaw replacement for Power Mod type (W)MM meter stacks and series WP, WEP, and WPC Uni-PAK.
	ECMT5	5th jaw Power Mod stack WMT. 1-ph in/1-ph out only.
	ECMF5i	Isolated 5th jaw. Allows for 5th jaw to be disconnected from the neutral while in place. For use on (W)MM and (W)MN stacks only.
	ECMFS	Meter socket replacement for Power Mod type (W)MM meter stacks and series WP, WEP, and WPC Uni-PAK.
	ECMFBM1	Breaker mounting replacement for 125 Amp Power Mod type (W)MM, (W)ML, WMT single phase meter stacks and series WP, WEP, WPL and WPC Uni-PAK.
	ECMFBM2	Breaker mounting replacement for 225 Amp Power Mod type (W)MM, (W)ML, WMT single phase meter stacks and series WP, WEP, WPL and WPC Uni-PAK.
	ECMFMC	Ringtype meter cover replacement for Power Mod type (W)MM Ringstyle residential meter stacks and WP, WEP, and WPC series ringstyle Uni-PAK. For 9" ring type.
	ECMFMCR	Ringless meter cover replacement for Power Mod type (W)MM ringless residential meter stacks and WP and WPC series ringless Uni-PAK.
	ECMMRLCK	Power Mod and Uni-PAK ring to ringless cover conversion kit for type (W)MM meter stacks and WP series Uni-PAK.
	ECMMRCK	Power Mod and Uni-PAK ringless to ring cover conversion kit for type (W)MM meter stacks and WP series Uni-PAK. For 9" ring type.

Power Mod and Uni-PAK

Multifamily Metering Accessories and Replacement Parts

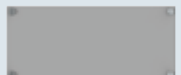
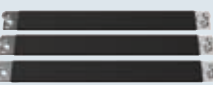
Accessory	Catalog No.	Description
	ECMFC	Bottom pull cover. Blank cover below the socket positions. For (W)MM Power Mod and WP, WEP, and WPC Uni-PAK.
	ECMFPS	Quick phase "Z" strap replacement for Power Mod type (W)MM meter stacks and series WP, WEP, and WPC Uni-PAK.
	ECWMLPS	Phase Straps for Lever bypass stacks. For use on 3-PH-In/1-PH-out, 125A, (W)ML stacks only. Only applicable to field phaseable units. Includes (2) line straps, (2) phase straps and (6) 1/4-20 hex nuts.
	ECMMFSP400	400A Power Mod metering switch main fuse bus replacement kit. Includes: bus plates, screws, hex nuts, washers and bolts (used to mount fuse in the module).
	ECMMFSP600	600A Power Mod metering switch main fuse bus replacement kit. Includes: bus plates, screws, hex nuts, washers and bolts (used to mount fuse in the module).
	ECMMFSP800	800A Power Mod metering switch main fuse bus replacement kit. Includes: bus plates, screws, hex nuts, washers and bolts (used to mount fuse in the module).
	ECAFL	(10) Arc flash labels.
	ECMMQRSCR	Power Mod QR and QJ 3-phase breaker mounting and strap screws. Kit contains (2) #10-32 x 2-7/16" screws and (3) 1/4-20 x 5/8" screws. For use on (W)ML and WMT Power Mod.
	ECMMGBE	Power Mod ground lug bar assembly kit. Adds 4 rows of NEMA stud kits to the ground bar. Can be used in bottom or top position. Includes 1 extension assembly and screws. Can be used on the following modules: WT_PU (1600-2400A), WTB (2000-2400A), WBT324X_(All), BFT (ALL).
	ECGLK3300	300 kcmil ground lug extension kit. Includes (3) lugs for ground. May be used on WB (up to 1200A), WBT, WTB and WT_PU (1600-2400A).
	ECGLK6300	300 kcmil ground lug extension kit. Includes (6) lugs for ground. May be used on WB (up to 1200A), WBT, WTB, WET and WT_PU (400-2400A). Included bonding strap is only necessary for the WB series.
	ECMFMC10	Ring-type meter cover for 10" opening. For (W)MN stacks only.
	ECWML10	Replacement 10" ringless meter socket cover for use on 125A (W)ML, (W)MLZ and (W)MLZF stacks that are single-phase out only.
	ECWMLC	Bottom pull cover. Replacement part only. Only to be used on 125A (W)ML.
	ECWMLZEP	Secondary cross bus side cover plate. Replacement part only. For use on fusible meter stacks (W)MLZ(F).
	ECWMLZBP	Bottom removable endwall plate for (W)MLZ(F) stacks. Replacement part only.
	ECWMLZFBUS	Secondary cross bus assembly for (W)MLZ(F) stacks. These 3 bus bars are installed toward the base of the (W)MLZ stack to create a secondary bus connection to an adjacent (W)MLZF or (W)MLZ stack. Includes (3) bus bars and (6) hex nuts. Replacement part only.

Power Mod and Uni-PAK

Multifamily Metering Accessories and Replacement Parts

Replacement Breaker Covers

These replacement metal covers (breaker side) are for WML, WMT and other three-phase modules manufactured prior to February 5, 2016. Prior to this date, these stacks were made to be only compatible with the QJ breaker. The QR breaker replaced the QJ breaker, so for these modules to be compatible with the QR breaker they will need a cover conversion kit from the table below. Stacks manufactured after February 5, 2016 will accept both QJ and QR breakers without needing a cover kit.

Accessory	Catalog No.®	Description
	ECWML3BC1	RX breaker side metal door cover for WML13225RJ accepts QR and QJ breaker.
	ECWML3BC2	RX breaker side metal door cover for WML23225RJ accepts QR and QJ breaker.
	ECWML3BC3	RX breaker side metal door cover for WML33225RJ accepts QR and QJ breaker.
	ECWML3BC4	RX breaker side metal door cover for WML43225RJ accepts QR and QJ breaker.
	ECML3BC1	RX breaker side metal door cover for ML13225RJ accepts QR and QJ breaker.
	ECML3BC2	RX breaker side metal door cover for ML23225RJ accepts QR and QJ breaker.
	ECML3BC3	RX breaker side metal door cover for ML33225RJ accepts QR and QJ breaker.
	ECML3BC4	RX breaker side metal door cover for ML43225RJ accepts QR and QJ breaker.
	ECW3MMUBC1	RX breaker side metal door cover for W3MM1200U accepts QR and QJ breaker.
	ECW3MMUBC2	RX breaker side metal door cover for W3MM2200U accepts QR and QJ breaker.
	ECW3MMUBC3	RX breaker side metal door cover for W3MM3200U accepts QR and QJ breaker.
	ECW3MMUBC4	RX breaker side metal door cover for W3MM4200U accepts QR and QJ breaker.
	ECW3MMBC1	RX breaker side metal door cover for W3MM1200 accepts QR and QJ breaker.
	ECW3MMBC2	RX breaker side metal door cover for W3MM2200 accepts QR and QJ breaker.
	ECW3MMBC3	RX breaker side metal door cover for W3MM3200 accepts QR and QJ breaker.
	ECW3MMBC4	RX breaker side metal door cover for W3MM4200 accepts QR and QJ breaker.
	ECWMT3BC1	RX breaker side metal door cover for WMT13225J accepts QR and QJ breaker.
	ECWMT3BC2	RX breaker side metal door cover for WMT23225J accepts QR and QJ breaker.
	ECWMT3BC3	RX breaker side metal door cover for WMT33225J accepts QR and QJ breaker.
	ECMT3BC1	RX breaker side metal door cover for MT13225J accepts QR and QJ breaker.
	ECMT3BC2	RX breaker side metal door cover for MT23225J accepts QR and QJ breaker.
	ECMT3BC3	RX breaker side metal door cover for MT33225J accepts QR and QJ breaker.
	ECW3USSBC1	RX breaker side metal door cover for W3MM1225USS accepts QR and QJ breaker.
	ECW3USSBC2	RX breaker side metal door cover for W3MM2225USS accepts QR and QJ breaker.
	ECW3USSBC3	RX breaker side metal door cover for W3MM3225USS accepts QR and QJ breaker.

Power Mod and Uni-PAK

Tenant Circuit Breakers



Amperage	10K AIC	22K AIC	42K AIC	65K AIC	100K AIC
	Type QP	Type QPH	—	Type HQP	—

For use in 125 Amp and 225^① Amp single phase output WMM, WML, WMT, WP, WPC, WEP, WPL metering^③

60	Q260	Q260H	Q260HH	Q260HH	—
70	Q270	Q270H	Q270HH	Q270HH	—
80	Q280	Q280H	Q280HH	Q280HH	—
90	Q290	Q290H	Q290HH	Q290HH	—
100	Q2100	Q2100H	Q2100HH	Q2100HH	HQ2100H
110	Q2110	Q2110H	Q2110HH	Q2110HH	—
125	Q2125	Q2125H	Q2125HH	Q2125HH	HQ2125H

For use in 100 Amp, 3- phase output WML meter stacks only

60	Q360	Q360H	Q360HH	Q360HH	—
70	Q370	Q370H	Q370HH	Q370HH	—
80	Q380	Q380H	Q380HH	Q380HH	—
90	Q390	Q390H	Q390HH	Q390HH	—
100	Q3100	Q3100H	Q3100HH	Q3100HH	—

For use in 225^① Amp single phase output WMM, WML, WMT, WP, WPC, WEP, WPL metering^③

	Type QS ^②	Type QSH ^②	Type QSHH	Type HQS ^②	Type HQSH ^②
100	QS2100	QS2100H	QSH2100	QS2100HH	HQS2100H
110	QS2110	QS2110H	QSH2110	QS2110HH	HQS2110H
125	QS2125	QS2125H	QSH2125	QS2125HH	HQS2125H
150	QS2150	QS2150H	QSH2150	QS2150HH	HQS2150H
175	QS2175	QS2175H	QSH2175	QS2175HH	HQS2175H
200	QS2200	QS2200H	QSH2200	QS2200HH	HQS2200H
225	QS2225	QS2225H	QSH2225	QS2225HH	HQS2225H

For use in 225 Amp 3-phase output WML and WMT meter stacks only

Amperage	Type QR2	Type QRH2	Type HQR2	Type HQR2H
100	QR23B100	QRH23B100	HQR23B100	HQR23B100H
125	QR23B125	QRH23B125	HQR23B125	HQR23B125H
150	QR23B150	QRH23B150	HQR23B150	HQR23B150H
175	QR23B175	QRH23B175	HQR23B175	HQR23B175H
200	QR23B200	QRH23B200	HQR23B200	HQR23B200H
225	QR23B225	QRH23B225	HQR23B225	HQR23B225H

① QP Breakers will fit in 225A WMM, WML, and WMT meter stacks.

② QS series rates with Murray circuit breakers.

③ Breaker selection (when applied to Uni-PAK) applies to WP, WPC, WEP, WPL, Uni-PAK metering only. QS breakers will not fit in SP or MP series.

Power Mod and Uni-PAK

Tenant Circuit Breakers

QS Breaker¹

Power Mod's core offering of residential Meter Stacks, type WMM, offers the widest product offering and flexibility in the industry. Each meter stack houses the QuickSystem features to maximize productivity and minimize labor costs. To further simplify installation, our 225 Amp meter stacks feature the QS breaker. The QS breaker adds to the Siemens exclusive feature set in our Power Mod product line. Benefits and part numbers include:

- An exclusive side wired design saves wiring space and eliminates difficult "S bends"
- No need for costly filler plates — QS 225 Amp breaker takes the same space as standard 100 Amp QPs
- Single right hand bend wiring - saves time and wire
- Provides 100K AIC flexibility from 100 up to 225 Amps
- 10K to 100K AIC Series Rating

QS Breaker

Breaker Type	QS	QSH	QSHH	HQS	HQSH
Amperage	10K AIC	22K AIC	42K AIC	65K AIC	100K AIC
100	QS2100	QS2100H	QSH2100	QS2100HH	HQS2100H
110	QS2110	QS2110H	QSH2110	QS2110HH	HQS2110H
125	QS2125	QS2125H	QSH2125	QS2125HH	HQS2125H
150	QS2150	QS2150H	QSH2150	QS2150HH	HQS2150H
175	QS2175	QS2175H	QSH2175	QS2175HH	HQS2175H
200	QS2200	QS2200H	QSH2200	QS2200HH	HQS2200H
225	QS2225	QS2225H	QSH2225	QS2225HH	HQS2225H

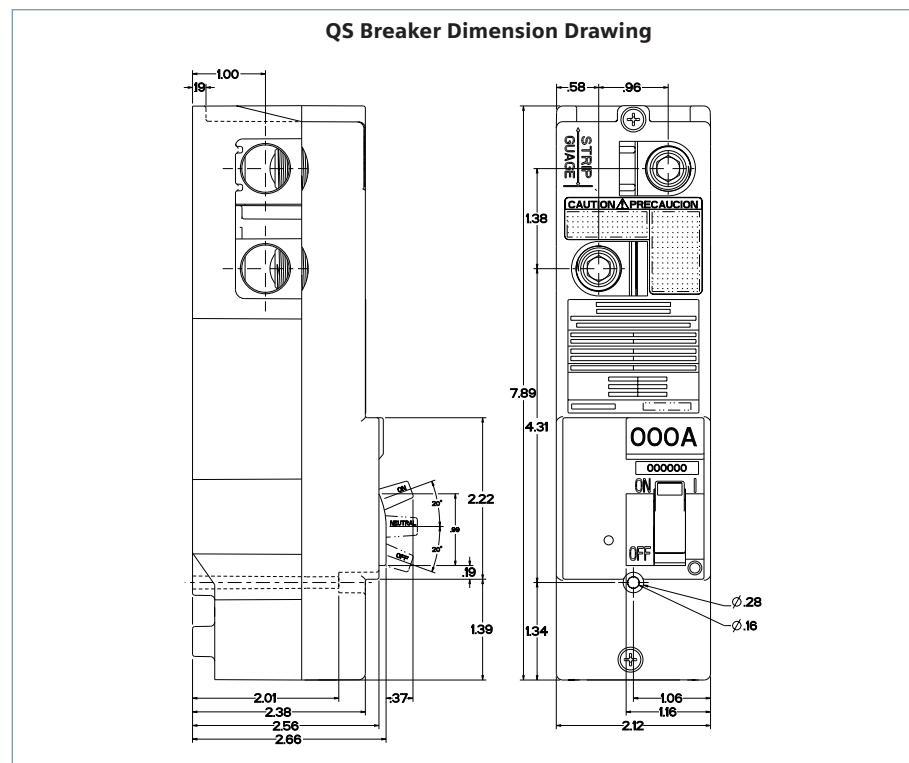

¹ For Power Mod information, please refer to Section 2, page 2-49

Uni-PAK Metering

Accessories

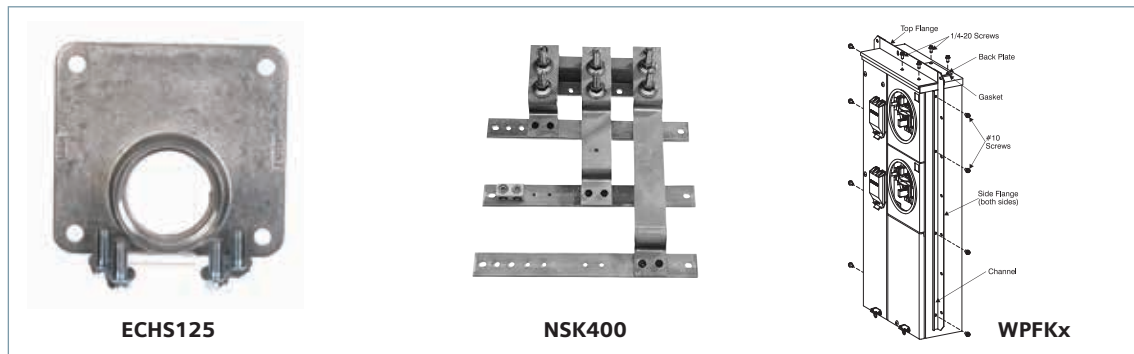

Uni-PAK Lug Kits

Catalog No.	Description
-------------	-------------

Uni-PAK NEMA Stud Kits (WEP ONLY) ⑥

WPSK400	Fits 300 - 400A
WPSK600	Fits 500 - 600A
WPSK800	800A
WPSK1000	1000A

Uni-PAK Alternate Lug Kits (WP ONLY)

WPLK2400	400A Bus Lug Kit (2) #4-250
WPLK2600	600A Bus Lug Kit (3) #6-250

Lug Kits (WPL ONLY) ⑤

H56476	3/0-800 kcmil
H60162	(2) 1/0-250 kcmil OR (1) #4-600 kcmil
H68752-1	(3) #6-250 kcmil
H56732	(2) #4-350 kcmil
H56732-M	(2) #4-500 kcmil

Semi-flush Mounting Kits (WEP only)

Flange Kit Number	Designed for use with:
WPFK1	WEP2211, WTEG2211
WPFK2	WEP3311, WTEG2211
WPFK3	WEP4411, WTEG4411
WPFK4	WEP4511, WTEG4511, WEP4611, WTEG4611
WPFK5	WEP6511, WTEG6511, WEP6611, WTEG6611
WPFK6	WEP4212, WTEG4212
WPFK7	WEP4312, WTEG4312
WPFK8	WEP4412, WTEG4412
WPFK9	WEP6412, WTEG6412
WPFK10	WEP6512, WTEG6512, WEP6612, WTEG6612
WPFK11	WEP10612, WTEG10612
WPFK12	WEP5411, WTEG5411
WPFK13	WEP8612, WTEG8612

Uni-PAK Accessories

Catalog No.	Description
-------------	-------------

Type "HD" Conduit Hubs

EC56854	2" Conduit Hub [®]
EC56855	2½" Conduit Hub [®]
EC56856	3" Conduit Hub
EC56857	3½" Conduit Hub
EC56858	4" Conduit Hub
EC56933S	Closure Plate

Type "RX" Conduit Hubs

EC38594	¾" Conduit Hub
EC38596	1" Conduit Hub
EC38597	1¼" Conduit Hub
EC38598	1½" Conduit Hub
EC38599	2" Conduit Hub
EC38600	2½" Conduit Hub
EC38595	Closure Plate
EC9747-1113	Adapter plate for HD/RX [®]

Cover Plate

ECPP	Plastic Ring Style [®]
ECCP3	Plastic Ringless Style

Filler Plates

ECQF3	1" Filler Plate
ECCP3U [®]	4" to 2" Filler Plate

① Not for use on lever bypass units.

② Order NSK600 and PLK600 kits for use with 800 Amp PAK. CU Cable only approved with 800A device.

③ Use Adapter plate with RX hubs for PAK units.

④ These items made of Adapter plate and equivalent RX hub.

⑤ Lug kits should be chosen based on the wire size being run to the unit. Wire should be sized according to the National Electrical Code. Lugs are sold separately. On 400-600A applications, a total of 3 lugs are required to wire the line side of the device. Lugs sold in packs of 2 pieces.

⑥ To be used with compression or mechanical lugs. Power Mod type LK_N2(E) lug kits can be used. View cutsheet for specific lug kit options.

Meter Centers

OBSOLETE Modular Metering Replacement Parts Kits

Selection

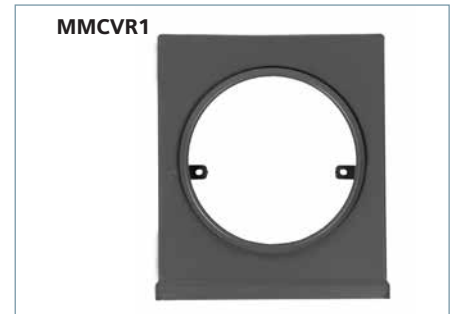

- All kits come with appropriate hardware and instruction sheet for safe installation
- Packages are stocked in specified Quantities and cannot be substituted or changed

Part Number	Description	Contents
Breaker Covers		
GMBC1 ^{①②}	Group Metering Breaker Cover - 125Amp Positions	One Top and bottom black plastic breaker cover piece, 1 gasket, and a locking clip
GMBC2 ^{①②}	Group Metering Breaker Cover - 200Amp Positions	Top and bottom black plastic breaker cover pieces, gasket, and locking clip
Meter Covers		
MMCVR1 ^①	Modular Metering Covers 125A Ring Style	1 Ringstyle meter cover welded with support brackets and painted
MMCVR1R ^①	Modular Metering Covers 125A Ringless	1 Ringless style meter cover welded with support brackets and painted
MMCVR2 ^①	Modular Metering Covers 200A Ring Style	1 Ringstyle meter cover welded with support brackets and painted
MMCVR2R ^①	Modular Metering Covers 200A Ringless	1 Ringless style meter cover welded with support brackets and painted
MMCVRLW	Modular Metering Bottom Cover (neutral access cover)	Smallest (bottom) cover on meter stack and screw included
MMCVRSCR	Modular Metering Cover Screws	Bag of 10 screws
PAKMCVRR ^②	Tenant cover for Ring Style Uni-Pak Meter Center	1 Ringstyle meter cover welded with support brackets and painted
PAKMCVRL ^②	Tenant cover for RingLess Uni-Pak Meter Center	1 Ringless style meter cover welded with support brackets and painted



Meter Socket/Breaker Mounting

MMBMT1 ^①	Modular Metering Breaker Mounting S/A 125A	Breaker Mounting assembly includes provision for 125 or 200A breaker
MMBMT2 ^①	Modular Metering Breaker Mounting S/A 200A	
MMSCK1 ^{①②}	Modular Metering Meter Socket Assembly 125A	Meter Socket assembly includes jaws, straps, and hardware – see picture above
MMSCK2 ^{①②}	Modular Metering Meter Socket Assembly 200A	
MMSRPK ^③	Replacement parts for 125A pre-1991 modular metering (see tip below)	1 red plastic base, 4 jaws and connecting line straps

Loose Parts Kits^①

MMPK11	Modular Metering Loose Parts Kit 125A 1 PHASE	All loose screw bags, labels, instruction sheet and aluminum sealing ring (No SBJ)
MMPK13	Modular Metering Loose Parts Kit 125A 3 PHASE	
MMPK21	Modular Metering Loose Parts Kit 200A 1 PHASE	
MMPK23	Modular Metering Loose Parts Kit 200A 3 PHASE	

- ① Fits modular metering made from 1992-2009 and PAK devices from 1992-2003.
- ② Fits PAK devices from 2004-2011
- ③ Fits 125A modular metering and PAK made from 1980-1991 ONLY. Not compatible with EUSERC style PAK (EUSERC versions contain suffix W/WF). No other replacement parts available.

Tips

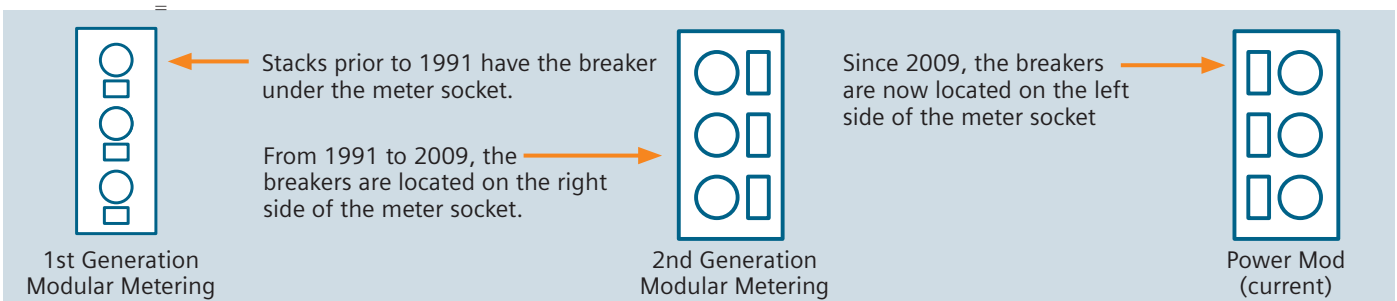

Power Mod

WMM Residential Meter Stacks Rating Charts

Use the tables below to determine the correct combination of equipment and circuit breakers for the available fault current. This chart provides series rating information for the most common applications. For a complete series rating chart please contact your local sales office.

Available Fault Current Rms Symmetrical Amps At 120/240 Volts Maximum	Service Entrance Modules ^①	Meter Module Branch Circuit Breakers	Load Center Branch Circuit Breakers
to 10,000	Series WB, WB_U, WBM, WBM_U WEB, WEB_U, WEBM, WEBM_U WS_U, WES_U WTB_U, WET_U WXB, WXB_U	QP, QPH, HQP (2 pole, 15–125A) ^②	QP, QPH, HQP, QT, QAF, QAFH, QPF, QPHF, QE, QEH
		QS, QSH, QSHH, HQS, HQSH (2 pole, 100–225A) ^③	
to 22,000	Series WB, WB_U, WBM, WBM_U WEB, WEB_U, WEBM, WEBM_U WXB, WXB_U	QPH, HQP (2 pole, 15–125A) ^②	QP, QPH, HQP, QT, QAF, QAFH, QPF, QPHF, QE, QEH
		QS, QSH, QSHH, HQS, HQSH (2 pole, 100–225A) ^③	
	Series WS_U, WES_U WXS	QPH, HQP (2 pole, 15–125A) ^②	
		QS, QSH, QSHH, HQS, HQSH (2 pole, 100–225A) ^③	
	Series WTB_U, WET_U	QPH, HQP (2 pole, 15–125A) ^②	
		QSH, QSHH, HQS, HQSH (2 pole, 100–225A) ^③	
to 42,000	Series WB, WB_U, WBM, WBM_U WEB, WEB_U, WEBM, WEBM_U WXB, WXB_U	QPH, HQP (2 pole, 15–125A) ^②	QP, QPH, HQP, QT, QAF, QAFH, QPF, QPHF, QE, QEH
		QS, QSH, QSHH, HQS, HQSH (2 pole, 100–225A) ^③	
	Series WS_U, WES_U WXS	QPH, HQP (2 pole, 15–125A) ^②	
		QS, QSH, QSHH, HQS, HQSH (2 pole, 100–225A) ^③	
	Series WTB_U, WET_U	HQP (2 pole, 15–125A) ^②	
		QSHH, HQS, HQSH (2 pole, 100–225A) ^③	
to 65,000	Series WB, WB_U, WBM, WBM_U WEB, WEB_U, WEBM, WEBM_U WXB, WXB_U	QPH, HQP (2 pole, 15–125A) ^②	QP, QPH, HQP, QT, QAF, QAFH, QPF, QPHF, QE, QEH
		QS, QSH, QSHH, HQS, HQSH (2 pole, 100–225A) ^③	
	Series WS_U, WES_U WXS	QPH, HQP (2 pole, 15–125A) ^②	
		QS, QSH, QSHH, HQS, HQSH (2 pole, 100–225A) ^③	
	Series WTB_U, WET_U	HQP (2 pole, 15–125A) ^②	
		HQS, HQSH (100–225A) ^③	
to 100,000	Series WB_U, WBM_U, WEB_U, WEBM_U WS_U, WES_U WXB_U, WXS	QS, QSH, QSHH, HQS, HQSH (2 pole, 100–225A) ^③	QP, QPH, HQP, QT, QAF, QAFH, QPF, QPHF, QE, QEH
		Series WTB_U, WET_U	

^① Service Entrance Modules:

WB, WXB, and WEB have 65k AIC breakers factory installed [(JXD2-A, JXD6-A) (LXD6-A) (MXD6) (NXD6) (PXD6) (RXD6)]
 WB_U, WXB_U, and WEB_U have 100k AIC breakers factory installed [(HJXD6-A) (HLXD6-A) (HMXD6) (HNXD6) (HPXD6) (HRXD6)]
 WS_U and WES_U are fused switches (Class T – 300 volt)
 WTB_U and WET_U have NO overcurrent protection

^② WMM 125 amp, single phase

^③ WMM 225 amp, single phase (accepts QS or QP breakers)

Power Mod

WML and WMT Commercial Meter Stacks Rating Charts

Use the tables below to determine the correct combination of equipment and circuit breakers for the available fault current. This chart provides series rating information for the most common applications. For a complete series rating chart please contact your local sales office.

Available Fault Current Rms Symmetrical Amps At 120/240V Max 1-Phase, 240V Max 3-Phase	Service Entrance Modules ^①	Meter Module Branch Circuit Breakers	Load Center Branch Circuit Breakers
to 10,000	Series WB, WB_U, WBM, WBM_U WEB, WEB_U, WEBM, WEBM_U WS_U, WES_U WTB_U, WET_U WXB, WXB_U WXS	QP, QPH, HQP (2 pole, 15–125A) ^③ QS, QSH, QSHH, HQS, HQSH (2 pole, 100–225A) ^③	QP, QPH, HQP, QT, QAF, QAFH, QPF, QPHF, QE, QEH
		QP, QPH, HQP (3 pole, 15–100A) ^④	
		QR2, QRH2, HQR2, HQR2H (3 Pole, 100–225A) ^⑤	
		JXD2-A, JD6-A, JXD6-A (2 and 3 pole, 200–400A) ^⑥	
		LD6-A, LXD6-A ^⑦	
to 22,000	Series WB, WB_U, WBM, WBM_U WEB, WEB_U, WEBM, WEBM_U WXB, WXB_U	QPH, HQP (2 pole, 15–125A) ^③ QS, QSH, QSHH, HQS, HQSH (2 pole, 100–225A) ^③	QP, QPH, HQP, QT, QAF, QAFH, QPF, QPHF, QE, QEH
		QPH, HQP (3 pole, 15–100A) ^④	
		QR2, QRH2, HQR2, HQR2H (3 Pole, 100–225A) ^⑤	
		QPH, HQP (2 pole, 15–125A) ^③ QS, QSH, QSHH, HQS, HQSH (2 pole, 100–225A) ^③	
	Series WS_U, WES_U WXS	QPH, HQP (3 pole, 15–100A) ^④	
		QR2, QRH2, HQR2, HQR2H (3 Pole, 100–225A) ^⑤	
		QPH, HQP (2 pole, 15–125A) ^③ QSH, QSHH, HQS, HQSH (2 pole, 100–225A) ^③	
	Series WTB_U WET_U	QPH, HQP (3 pole, 15–100A) ^④	
		QRH2, HQR2, HQR2H (3 Pole, 100–225A) ^⑤	
	to 25,000	Series WB, WB_U, WBM, WBM_U WEB, WEB_U, WEBM, WEBM_U WS_U, WES_U WTB_U, WET_U WXB, WXB_U, WXS	
LD6-A, LXD6-A ^⑦			
to 42,000	Series WB, WB_U, WBM, WBM_U WEB, WEB_U, WEBM, WEBM_U WXB, WXB_U	QPH, HQP (2 pole, 15–125A) ^③ QS, QSH, QSHH, HQS, HQSH (2 pole, 100–225A) ^③	QP, QPH, HQP, QT, QAF, QAFH, QPF, QPHF, QE, QEH
		QPH, HQP (3 pole, 15–100A) ^④	
		QR2, QRH2, HQR2, HQR2H (3 Pole, 100–225A) ^⑤	
		QPH, HQP (2 pole, 15–125A) ^③ QS, QSH, QSHH, HQS, HQSH (2 pole, 100–225A) ^③	
	Series WS_U, WES_U WXS	QPH, HQP (3 pole, 15–100A) ^④	
		QR2, QRH2, HQR2, HQR2H (3 Pole, 100–225A) ^⑤	
		HQP (2 pole, 15–125A) ^③ QSHH, HQS, HQSH (2 pole, 100–225A) ^③	
	Series WTB_U WET_U	HQP (3 pole, 15–100A) ^④	
		HQR2, HQR2H (3 Pole, 100–225A) ^⑤	QP, QPH, HQP

Power Mod

WML and WMT Commercial Meter Stacks Rating Charts

Use the tables below to determine the correct combination of equipment and circuit breakers for the available fault current. This chart provides series rating information for the most common applications. For a complete series rating chart please contact your local sales office.

Available Fault Current Rms Symmetrical Amps At 120/240V Max 1-Phase, 240V Max 3-Phase	Service Entrance Modules ^①	Meter Module Branch Circuit Breakers	Load Center Branch Circuit Breakers To 10,000
to 65,000	Series WB, WB_U, WBM, WBM_U WEB, WEB_U, WEBM, WEBM_U WXB, WXB_U	QPH, HQP (2 pole, 15–125A) ^③ QS, QSH, QSHH, HQS, HQSH (2 pole, 100–225A) ^③	QP, QPH, HQP, QT, QAF, QAFH, QPF, QPHF, QE, QEH
		QPH, HQP (3 pole, 15–100A) ^④	
		QR2, QRH2, HQR2, HQR2H (3 Pole, 100–225A) ^⑤	
	Series WS_U, WES_U WXS	QPH, HQP (2 pole, 15–125A) ^③ QS, QSH, QSHH, HQS, HQSH (2 pole, 100–225A) ^③	
		QPH, HQP (3 pole, 15–100A) ^④	
		QR2, QRH2, HQR2, HQR2H (3 Pole, 100–225A) ^⑤	
	Series WTB_U WET_U	HQP (2 pole, 15–125A) ^③ HQS, HQSH (2 pole, 100–225A) ^③	
		HQP (3 pole, 15–100A) ^④	
		HQR2, HQR2H (3 Pole, 100–225A) ^⑤	
to 100,000	Series WB_U, WBM_U, WEB_U, WEBM_U, WS_U, WES_U	QS, QSH, QSHH, HQS, HQSH (2 pole, 100–225A) ^③	QP, QPH, HQP, QT, QAF, QAFH, QPF, QPHF, QE, QEH
		QR2, QRH2, HQR2, HQR2H (3 Pole, 100–225A) ^⑤	
	Series WTB_U, WET_U WXB_U, WXS	HQSH (2 pole, 100–225A) ^③	
		HQR2H (3 Pole, 100–225A) ^⑤	

^① Service Entrance Modules:

WB, WXB, and WEB have 65k AIC breakers factory installed [(JXD2-A, JXD6-A) (LXD6-A) (MXD6) (NXD6) (PXD6) (RXD6)]
 WB_U, WXB_U, and WEB_U have 100k AIC breakers factory installed [(HJXD6-A) (HLXD6-A) (HMXD6) (HNXD6) (HPXD6) (HRXD6)]
 WS_U, WES_U and WMLZF are fused switches (Class T - 300 volt) - Series ratings are applicable to all switches with Class T – 300V fuses
 WTB_U and WET_U have NO overcurrent protection

^② No longer applicable

^③ WML and WMT 225 amp, single phase

^④ WML 100 amp, 3 phase

^⑤ WML and WMT 225 amp, 3 phase

^⑥ WML and WMK 400 amp, single and 3 phase

^⑦ WMK 600 amp, single and 3 phase

What is NEC[®] 240.87?

NEC 240.87 requires a means of reducing the arc energy for any circuit breaker that can be set at 1200A and above. The code has been revised for 2017 with a new list of approved methods to implement arc energy reduction. An overview of these methods is provided below. For further information regarding the code, please reference document no. PDFL-NECQA-0217, available in the download center (usa.siemens.com/downloadcenter).

Methods to reduce clearing time:

1. Zone-selective interlocking
2. Differential relaying
3. Energy-reducing maintenance switching with local status indicator
4. Energy-reducing active arc flash mitigation system
5. An instantaneous trip setting that is less than the available arcing current (2017)
6. An instantaneous override that is less than the available arcing current (2017)
7. An approved equivalent means



Power Mod

Understanding 2017 NEC 240.87 Arc Energy Reduction

Electronic Trip Unit (ETU) with DAS®

The Siemens Power Mod product line now offers main breaker modules with Dynamic Arc Sentry (DAS). This DAS solution complies with NEC240.87 by providing an energy-reducing maintenance switch with local status indication. These modules incorporate the new Sentron Sensitrip IV , SND-Frame , solid state breaker and are identified as WB(M) and WEB(M) units.

Modules with DAS will feature a blue, illuminated push-button under a clear cover mounted on the enclosure. To initiate maintenance mode – lowering the instantaneous settings – the user lifts the clear cover and presses the button. The button will illuminate – providing status indication – when the breaker has successfully transitioned into maintenance mode. The breaker will stay in maintenance mode until the push-button is depressed again and the light turns off.

Another benefit of the Siemens DAS solution is that the status indication may be clearly seen from across the room and in a variety of environments. Furthermore, the separate breaker cover is now larger than prior models , which allows the breaker handle extension to be stored inside the cover for easy access.

Power Mod offers multiple solutions to address NEC 240.87

Speak to a Siemens representative for more details.

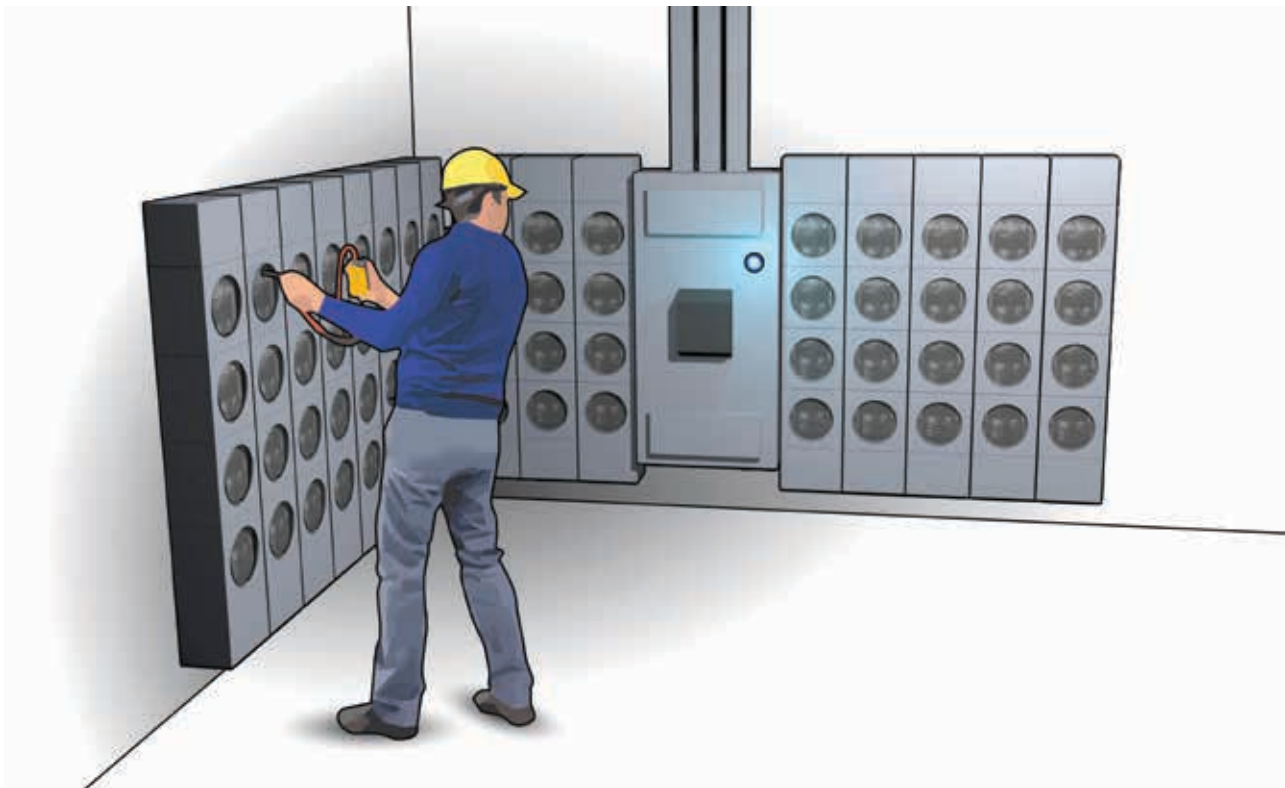

Power Mod

Power Mod™ Express Stocking Program

Welcome to the Power Mod Express program. Placing an order as Express will ensure shipping within 3 to 5 business days of the Power Mod units*. Orders should be placed through COMPAS. The list includes many Catalog No.s including mains, meter stacks, accessories and lug kits.

In order to qualify for an Express order:

- Must be ordered through COMPAS, with the "Express" box checked
- All units in the order need to be on the below list.
- Lug kits are the only exception and will not impact the Express status of the order.
- All order quantities per Catalog No. must be less than or equal to 5 units**
- If the order has Power Mod items outside the list below the overall order will receive a standard 10 day lead time.

Pick any item on this list, and we will ensure it gets shipped within 3 to 5 business days.

**Maximum quantity of 5 units per Catalog No.

Main Modules

Catalog No.	Description
WB1400C	POWMOD CKT BRKR MAIN 1PH 400A OH/UG 65K
WB1600C	POWMOD CKT BRKR MAIN 1PH 600A OH/UG 65K
WB1800C	POWMOD CKT BRKR MAIN 1PH 800A OH/UG 65K
WTB1400CU	POWMOD TAPBOX 1PH 400A OH/UG 100K
WTB3400CU	POWMOD TAPBOX 3PH 400A OH/UG 100K
WTB3800CU	POWMOD TAPBOX 3PH 800A OH/UG 100K
WS1400CU	POWMOD STD SWITCH MAIN 1PH 400A OH/UG 100K

Accessories & Auxiliary Modules

Catalog No.	Description
BE4	POWMOD INDOOR BUSSED ELBOW 15 IN 3P N1
BE412	POWMOD INDOOR BUSSED ELBOW 12 IN 3P N1
QC1	POWMOD QUICK CONNECT 1PH
QC4	POWMOD QUICK CONNECT 3PH
WSP1	POWMOD SPACER 1PH N3R
WSP3	POWMOD SPACER 3PH N3R

Meter Stack Modules

Catalog No.	Description
ML62125RJ	POWMOD INDOOR LEVER BYPASS METER STACK 6G 3PH IN 1PH OUT 125A RINGLESS 5J
MM52125J	POWMOD INDOOR METER STACK 125A 5G 3PH IN 1PH OUT RING TYPE 5J
MMZR60	POWMOD Z RAIL 60 INCH FOR WALL MOUNTING
MN42125J	POWMOD INDOOR ConEd RESI METER STACK 125A 4G 3PH IN 1PH OUT RING TYPE 5J
MN52125J	POWMOD INDOOR 125A 5G 3PH IN 1PH OUT RING TYPE 5J
WML33225RJ	POWMOD LEVER BYPASS METER STACK 3G 3PH I/O 225A RINGLESS
WML42125RJ	POWMOD LEVER BYPASS METER STACK 4G 3PH IN 1PH OUT 125A RINGLESS
WMN62125J	POWMOD ConEd RESI METER STACK 125A 6G 3PH IN 1PH OUT RING TYPE 5J

Continue to next page for expansive list of WMM meter stack modules

Lugs

*Any and all lug kits can be shipped through the Express program.

These kits include Catalog No.s such as LK12500N2, LK32500N2, LK33500N2, LK34500N2, and more.

*Express items are in stock at a 3rd party warehouse. Stock will not be visible in Industry Mall.

**This is because stock levels are set to 5 units per Catalog No., this does not apply to accessories or lug kits.

Power Mod

Power Mod™ Express Stocking Program

Siemens is excited to make available our very flexible residential meter stacks. Because many of our products are able to be field-modified to meet your needs, we have laid out which of our products you can express ship and modify on your own to meet your needs.

Instructions:

1. Find the product you desire in the second column.
2. Order the corresponding product in the first column.
3. Order the corresponding accessories indicated in the fourth column
4. Once your product arrives, perform the slight modification needed (noted in the fourth column).

WMM Tenant Modules

Catalog No. to Purchase	Field-Modified Unit	Description	Instructions on how to Modify*
WMM31125	WMM31125	WMM 125A 3G 1PH IN/OUT RING TYPE	No modification needed
	WMM31125J	WMM 125A 3G 1PH IN/OUT RING TYPE 5J	Add 5th Jaw via Kit (ECMF5)
WMM31125R	WMM31125R	WMM 125A 3G 1PH IN/OUT RINGLESS	No modification needed
	WMM31125RB	WMM 125A 3G 1PH IN/OUT RINGLESS HB	Add Bypass via Kit (ECMFH)
	WMM31125RJ	WMM 125A 3G 1PH IN/OUT RINGLESS 5J	Add 5th Jaw via Kit (ECMF5)
	WMM31125RJB	WMM 125A 3G 1PH IN/OUT RINGLESS HB 5J	Add 5th Jaw via Kit (ECMF5) & Bypass via Kit (ECMFH)
WMM41125	WMM41125	WMM 125A 4G 1PH IN/OUT RING TYPE	No modification needed
	WMM41125J	WMM 125A 4G 1PH IN/OUT RING TYPE 5J	Add 5th Jaw via Kit (ECMF5)
WMM41125R	WMM41125R	WMM 125A 4G 1PH IN/OUT RINGLESS	No modification needed
	WMM41125RB	WMM 125A 4G 1PH IN/OUT RINGLESS HB	Add Bypass via Kit (ECMFH)
	WMM41125RJ	WMM 125A 4G 1PH IN/OUT RINGLESS 5J	Add 5th Jaw via Kit (ECMF5)
	WMM41125RJB	WMM 125A 4G 1PH IN/OUT RINGLESS HB 5J	Add 5th Jaw via Kit (ECMF5) & Bypass via Kit (ECMFH)
WMM42125J	WMM42125J	WMM 125A 4G 3PH IN 1PH OUT 5J	No modification needed
WMM42125RJ	WMM42125RJ	WMM 125A 4G 3PH IN 1PH OUT RINGLESS 5J	No modification needed
	WMM42125RJB	WMM 125A 4G 3PH IN 1PH OUT RNGLES HB 5J	Add Bypass via Kit (ECMFH)
WMM42225J	WMM42225J	WMM 225A 4G 3PH IN 1PH OUT 5J	No modification needed
WMM42225RJ	WMM42225RJ	WMM 225A 4G 3PH IN 1PH OUT RINGLESS 5J	No modification needed
	WMM42225RJB	WMM 225A 4G 3PH IN 1PH OUT RNGLES HB 5J	Add Bypass via Kit (ECMFH)
WMM51125	WMM51125	WMM 125A 5G 1PH IN/OUT RING TYPE	No modification needed
	WMM51125J	WMM 125A 5G 1PH IN/OUT RING TYPE 5J	Add 5th Jaw via Kit (ECMF5)
WMM51125R	WMM51125R	WMM 125A 5G 1PH IN/OUT RINGLESS	No modification needed
	WMM51125RB	WMM 125A 5G 1PH IN/OUT RINGLESS HB	Add Bypass via Kit (ECMFH)
	WMM51125RJ	WMM 125A 5G 1PH IN/OUT RINGLESS 5J	Add 5th Jaw via Kit (ECMF5)
	WMM51125RJB	WMM 125A 5G 1PH IN/OUT RINGLESS HB 5J	Add 5th Jaw via Kit (ECMF5) & Bypass via kit (ECMFH)
WMM52125J	WMM52125J	WMM 125A 5G 3PH IN 1PH OUT RING TYPE 5J	No modification needed
WMM52125RJ	WMM52125RJ	WMM 125A 5G 3PH IN 1PH OUT RINGLESS 5J	No modification needed
	WMM52125RJB	WMM 125A 5G 3PH IN 1PH OUT RNGLES HB 5J	Add Bypass via Kit (ECMFH)
WMM52225J	WMM52225J	WMM 225A 5G 3PH IN 1PH OUT RING TYPE 5J	No modification needed
WMM52225RJ	WMM52225RJ	WMM 225A 5G 3PH IN 1PH OUT RINGLESS 5J	No modification needed
	WMM52225RJB	WMM 225A 5G 3PH IN 1PH OUT RNGLES HB 5J	Add Bypass via Kit (ECMFH)
WMM62125J	WMM62125J	WMM 125A 6G 3PH IN 1PH OUT RING TYPE 5J	No modification needed
WMM62125RJ	WMM62125RJ	WMM 125A 6G 3PH IN 1PH OUT RINGLESS 5J	No modification needed
	WMM62125RJB	WMM 125A 6G 3PH IN 1PH OUT RNGLES HB 5J	Add Bypass via Kit (ECMFH)

*If ordering a field modification accessory kit for adding a 5th jaw (ECMF5) or a horn bypass (ECMFH), these kits will be shipped separately from a different Siemens facility.

Power Mod is Proven to Save Time

It is not a secret that Siemens Power Mod is easy to install and saves contractors time. To quantify this we had a third party organization conduct a Time & Motion Study in order to identify how much time the Siemens Power Mod product saves the contractor compared to the competitors. The findings were shocking. The study found that Power Mod product could be installed 32-43% faster than the competitor's products. This averages out to an average time savings of 37.5%. Read the study for yourself, scan the QR code or visit this site usa.siemens.com/powermod-timestudy



Estimate Your Savings – fill in the blanks

Average number of labor hours needed to install one meter center lineup:			_____
Average cost per labor hour:	x		_____
Total labor cost per lineup	=		_____
Average number of lineups per job:	x		_____
Total labor cost per job	=		_____
Percent of average cost savings:	x		_____ .375
Your Total Average Job Savings	=		<div style="border: 1px solid black; width: 100px; height: 25px; display: inline-block;"></div>

Example:

Average number of labor hours needed to install one meter center lineup:			10
Average cost per labor hour:	x		\$70
Total labor cost per lineup	=		\$700
Average number of lineups per job:	x		12
Total labor cost per job	=		\$8,400
Percent of average cost savings:	x		.375
Your Total Average Job Savings	=		<div style="border: 1px solid black; padding: 2px 5px;">\$3,150</div>

**Published by
Siemens 2018**

Siemens Industry, Inc.
5400 Triangle Parkway
Norcross, GA 30092

Siemens Technical Support: 1-800-333-7421
info.us@siemens.com

Printed in USA
Order No. RPSA-MULTI-0918-CP
All Rights Reserved
© 2018, Siemens Industry, Inc.
usa.siemens.com/powermod

The technical data presented in this document is based on an actual case or on as-designed parameters, and therefore should not be relied upon for any specific application and does not constitute a performance guarantee for any projects. Actual results are dependent on variable conditions. Accordingly, Siemens does not make representations, warranties, or assurances as to the accuracy, currency or completeness of the content contained herein. If requested, we will provide specific technical data or specifications with respect to any customer's particular applications. Our company is constantly involved in engineering and development. For that reason, we reserve the right to modify, at any time, the technology and product specifications contained herein.

