

1

2

3

4

5

6

7

8

back view

front view

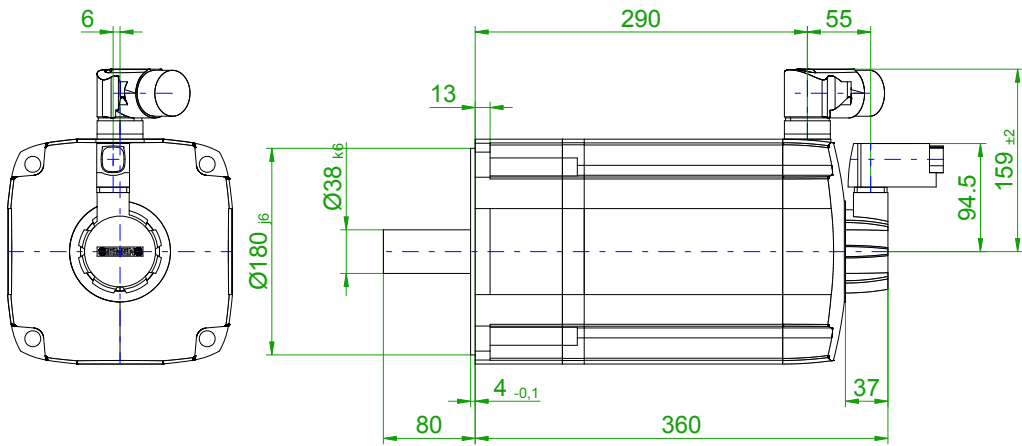

center hole
DIN 332-DR M12

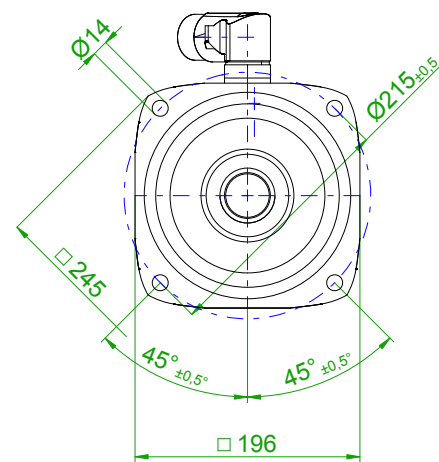

6-pole plug size 1.5
for power and brake

10-pole
signal plug

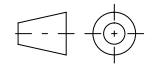
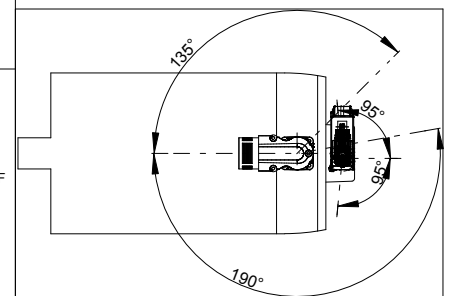
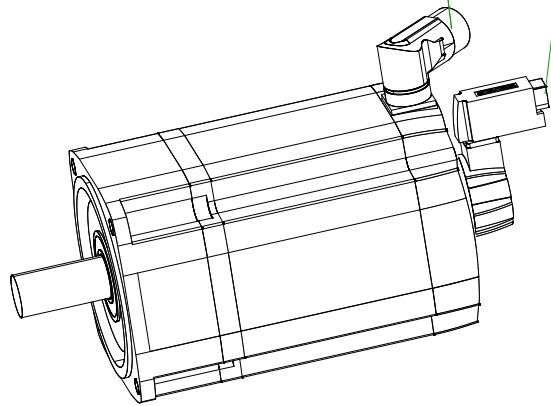
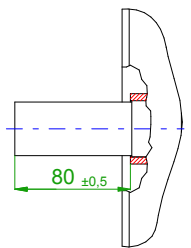

SIEMENS

Einheit / unit: mm

Synchron-Servomotor
Synchronous Servo Motor:

1FT7105-5AF71-1DH0

nicht tolerierte Maße /
not toleranced dimensions: ±1

Optionen / options:

Gewicht / mass:

50.4 kg

Maßstab / scale: ohne / without

Bemerkung / notice:

CAD CREATOR 2.2 (WWW-Version V02.20.00.00)

Druckdatum / print date:

05.06.2019