

SIEMENS

I-T-E[®] Molded Case Circuit Breakers

MD & ND-Frame
Information and
Instruction Guide



Information and Instructions

General Information

General

MD and ND-Frame Sentron™ Series circuit breakers, as shown on page 5, are for use in individual enclosures, switchboards, and power and distribution panel boards. They are available as thermal magnetic, with interchangeable trip units (types MD6, MXD6, ND6, NXD6-standard interruption level, HMD6, HMXD6, HND6, HNXD6-high interruption level, and CMD6, CND6 current limiting), instantaneous magnetic trip only (motor circuit protectors – types MXD6-ETI and CMD6-ETI) and molded case switches (types MXD6, NXD6, CMD6, CND6).

CMD6, CND6 type Sentron™ Series circuit breakers combine thermal magnetic construction for overload protection in conjunction with the MD and ND-Frame's standard "blow-apart" contacts. This arrangement provides for current limiting protection under high fault interrupting conditions as outlined in the National Electrical Code®, Article 240-11^① and UL 489^② standards. CMD6, CND6 type circuit breakers are fuseless and therefore eliminate the requirement of locating and replacing blown fuses should a high current fault occur. The common trip feature of the circuit breaker is completely retained so that all poles of the circuit breaker open when caused to trip due to an overload or short circuit.

Pressure wire connectors, suitable for use with aluminum or copper wire are available for all MD and ND-Frame circuit breakers. Rear connection studs or plug-in connector assemblies are also available (2 and 3-pole). The latter mounting arrangement permits the removal of the circuit breaker from its leads without physically coming in contact with either the line or load terminals. UL listed special features such as a shunt trip, auxiliary and alarm switches and undervoltage trip devices are available for internal mounting. The installation and or removal of these devices is to be accomplished by qualified personnel only. Information concerning them can be found on pages 25-27.

Thermal Magnetic

MD6, MXD6, ND6, NXD6, HMD6, HMXD6, HND6, HNXD6, CMD6, and CND6 type circuit breakers provide complete overload and short circuit protection by use of a time delay thermal trip element and an instantaneous magnetic trip device. Nominal instantaneous trip values are externally adjustable with 8 trip points as shown below.

Ampere Rating	Nominal Instantaneous Values			
	Low	2	3	4
500-600	3000	3430	3860	4280
700-800	4000	4570	5740	5710
900-1200	5000	5715	6430	7145

Ampere Rating	Nominal Instantaneous Values			
	5	6	7	High
500-600	4710	5140	5570	6000
700-800	6280	6850	7420	8000
900-1200	7860	8575	9290	10,000

① National Electrical Code (240-11)

"A current limiting overcurrent protective device, which, when interrupting currents in its current limiting range, will reduce the current flowing in the faulted circuit to a magnitude substantially less than that obtainable in the same circuit, if the device were replaced with a solid conductor having comparable impedance."

② Underwriters Laboratories (UL 489, Par. 2.5)

"A circuit breaker that does not employ a fusible element and that when operating within its current limiting range, limits the let-through I^2t to a value less than the I^2t of a 1/2 cycle wave of the symmetrical prospective current."

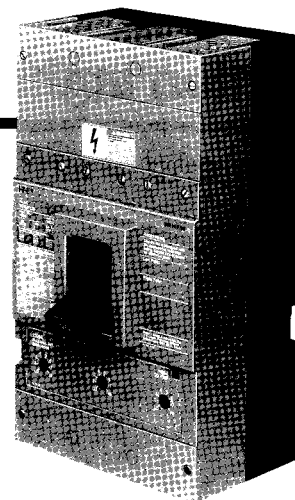

Circuit breakers are calibrated at the factory, under controlled temperature conditions for applications in a 40°C (104°F) ambient.

The cover on the trip unit is sealed to prevent access to the trip elements. Alterations of the calibration of these elements should not be attempted. Removal of the seals will void the UL listing for that specific trip unit. Catalog numbers for ordering and informational purposes can be found on pages 44-46.

Instantaneous Trip

ETI motor circuit interrupters (adjustable instantaneous magnetic trip only) are designed for use in welding circuits, motor circuits and combination starters where short circuit protection only is required. When used in combination starters, they serve in conjunction with motor protective relays to offer complete protection. The relays guard against motor overloads; the circuit breaker provides short circuit protection.

ETI is available for MD-Frame only, breaker types MXD6-ETI and CMD6-ETI. The available instantaneous adjustments are as follows.

Motor Full Load Amperes	ETI Trip Settings		Breaker Ampere Rating
	Adjustment	Amperes	
231-264	Low	3000	800 Low
264-292	2	3430	
292-330	3	3860	
330-362	4	4280	
362-395	5	4710	
395-428	6	5140	
428-462	7	5570	800 Stand.
462-490	High	6000	
308-352	Low	4000	
352-442	2	4570	
442-447	3	5740	
447-483	4	5810	
483-527	5	6280	800 High
527-571	6	6850	
571-616	7	7420	
616-660	High	8000	
385-440	Low	5000	
440-495	2	5715	
495-550	3	6430	
550-605	4	7145	800 High
605-660	5	7860	
660-715	6	8575	
715-800	7	9290	
	High	10000	

Information and Instructions

Operation and Maintenance

Molded Case Switch

A molded case switch is available in the MXD6, CMD6, NXD6 and CND6 type circuit breakers. This device employs the same operating mechanism as the thermal magnetic and magnetic only units. A preset instantaneous function has been factory installed to allow the switch to trip and protect itself against high fault conditions. No overload or low fault protection is provided. This protection must be supplied by separate overcurrent devices. Catalog information is located on pages 44 and 46.

Interrupting Ratings – Symmetrical RMS Amperes (kA) Based on UL 489 Standards

Interrupting ratings of the MD and ND-Frame circuit breakers are based on circuit and test conditions outlined in UL 489.

Breaker Type	RMS Symmetrical Amperes (kA)						
	UL A.I.R.					IEC A.I.R. ①	
	Volts AC			Volts DC		Volts AC (50-60Hz)	
	240	480	600	250	500 ②	220/240	380/415
MD6, MXD6, ND6, NDX6	65	50	25	30 (2-P)	25 (3-P)	65 (3-P)	50 (3-P)
HMD6, HMXD6, HND6, HNXD6	100	65	50	30 (2-P)	50 (3-P)	100 (3-P)	65 (3-P)
CMD6, CND6 ③	200	100	65	30 (2-P)	50 (3-P)	200 (3-P)	100 (3-P)

① Meets requirements of IEC 157-1 (P1).

② For 500V dc applications the customer's power supply and load must be wired as shown (Figure 1).

③ CMD6 and CND6 type circuit breakers are current limiting at 240V ac 480V ac.

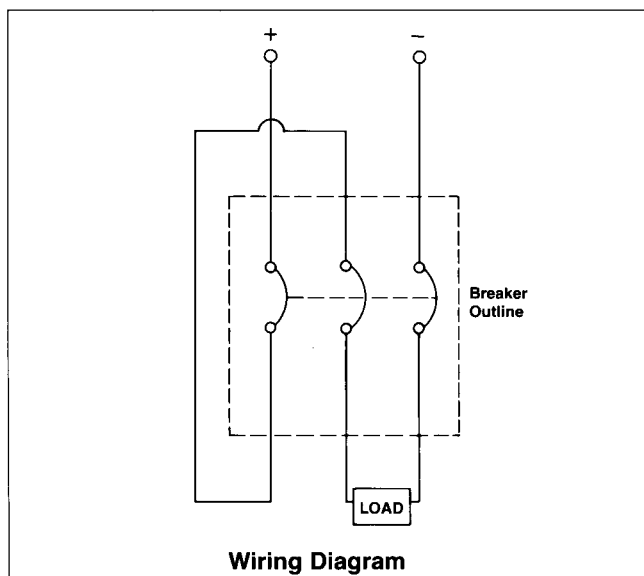

Figure 1

Circuit Breaker Operation

With the mechanism latched and the contacts open, the operating handle will be in the OFF position. Moving the handle to the ON position closes the contacts and establishes a circuit through the breaker. Under overload or short circuit conditions sufficient to automatically trip or open the breaker, the operating handle moves to a position between ON and OFF. To relatch the circuit breaker after automatic operation, move the operating handle to the extreme OFF position. The circuit breaker is now ready for reclosing.

The overcenter toggle mechanism is trip free of the operating handle. The circuit breaker, therefore, cannot be held closed by means of the handle should a tripping condition exist. After automatic operation, the handle assumes an intermediate position between ON and OFF, displaying a clear indication of tripping.

Maintenance

Experience has shown that properly applied molded case circuit breakers normally do not require maintenance. However, some industrial users may choose to establish an inspection and maintenance procedure to be carried out on a regular basis. For detailed information, consult applicable NEMA publications or your local Siemens sales office.

SPECIAL NOTE:

CMD6 and CND6 circuit breakers are not UL listed as interchangeable trips—DO NOT REMOVE TRIP UNIT and replace with another. Removal of trip unit voids UL listing.

NOTE:

Present UL Standard 489 allows the following tolerances for instantaneous adjustment response.

Thermal-Magnetic Breakers	
Instantaneous Adjustment	
Low	High
±25%	±20%
Instantaneous Only Breakers	
Each Adjustment	
-20%	+30%

I-T-E MD and ND-Frame Outline Drawings^①

2 and 3-Pole^②

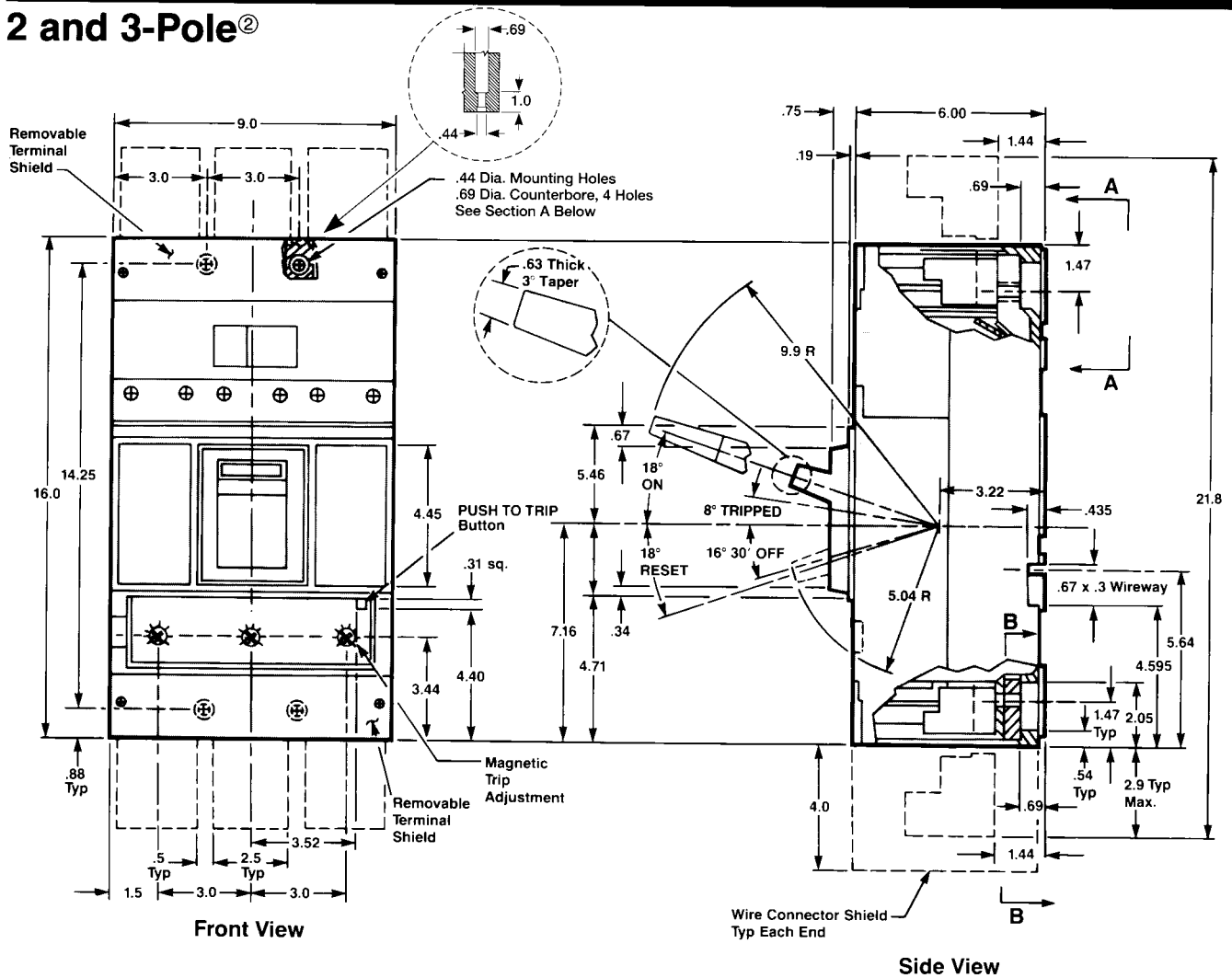

Handle Operating Forces





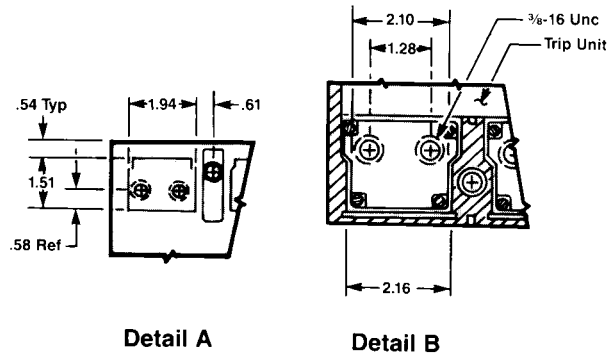
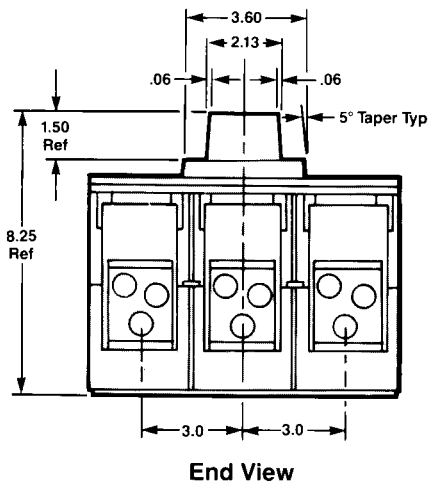

Operation	Lb. wo/Ext.	Lb. w/Ext.
OFF to ON	75	40
ON to OFF	85	46
TRIPPED to RESET	130	70

- ① All drawing dimensions are shown in inches.
- ② Two and 3-pole breakers are the same physical size. Current carrying parts are omitted from the center in 2-pole breakers.

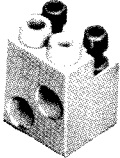
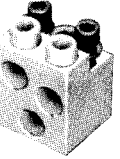
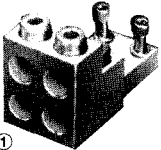

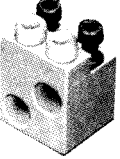
I-T-E Pressure Wire Connectors

Table 1 – Connector Selection Chart

Connector ^② Catalog Numbers	Circuit Breaker Ampere Rating	Connector Wire Range	Set Screw Torque	For Use With Type(s)
TA2K500 	500-600	(1-2) #1 AWG-500 kcmil (Cu/Al)	375 in. lb.	MD6, MXD6, SMD6 HMD6, HMXD6, SHMD6, CMD6, SCMD6
TA3K500 	700-800	(1-3) #1 AWG-500 kcmil (Cu/Al)	375 in. lb.	MD6, MXD6, SMD6 HMD6, HMXD6, SHMD6, CMD6, SCMD6, MD6-ETI, CMD6-ETI
TA4P8500 ^① 	800-1200	(4) 250-500 kcmil (Cu/Al)	375 in. lb.	ND6, NXD6, SND6 HND6, HNXD6, SHND6, CND6, SCND6
TA4N8500 	800-1200	(4) 250-500 kcmil (Cu/Al)	375 in. lb.	ND6, NXD6, SND6 HND6, HNXD6, SHND6, CND6, SCND6
TC2K500 	500-600	(1-2) #1 AWG-500 kcmil (Cu)	375 in. lb.	MD6, MXD6, SMD6 HMD6, HMXD6, SHMD6, CMD6, SCMD6
TC3K350 	700-800	(1-3) #1 AWG-350 kcmil (Cu)	375 in. lb.	MD6, MXD6, SMD6 HMD6, HMXD6, SHMD6, CMD6, SCMD6
TA2N8750 	700-800	(2) 600-750 kcmil (Cu/Al)	375 in. lb.	MD6, MXD6, SMD6 HMD6, HMXD6, SHMD6, CMD6, SCMD6
TA3N8750 	700-1200	(3) 250-400 kcmil (Cu/Al) (3) 500-700 kcmil (Cu/Al)	375 in. lb.	ND6, NXD6, SND6 HND6, HNXD6, SHND6, CND6, SCND6

① Connectors supplied in kits only.

② All connector bodies will fit on all MD and ND-Frame circuit breakers regardless of trip unit ampere rating.

I-T-E Internal Accessories

Mechanical and Electrical Check

Shunt Trip

- Reset and turn circuit breaker ON.
- Attach test circuit to accessory leads. When the test voltage reaches 55 percent or more of the rated coil voltage, the circuit breaker should trip.
- With breaker TRIPPED or OFF, check to make sure coil circuit has opened.

Electrical Data For Shunt Trip

Coil Voltage	Inrush Current At Rated Voltage (Amperes)	Catalog Number
60 Cycles AC		
120	0.55	S01MN6
208	0.61	S02MN6
240	0.69	S03MN6
277	0.76	S15MN6
480	0.30	S04MN6
600	0.40	S06MN6
DC		
12	2.55	S16MN6
24	1.70	S07MN6
48	0.60	S09MN6
125	0.57	S11MN6
250	0.84	S13MN6

Undervoltage Trip

- With breaker in TRIPPED position, connect test circuit to accessory leads. Energize undervoltage trip device at 85 percent of the marked rated voltage of the coil. Reset and turn breaker handle ON.
- Reduce voltage to 35 percent of rated coil voltage. Circuit breaker must trip.

Electrical Data For Undervoltage (UV) Trip

Coil Voltage	Sealed-In Current At Rated Voltage (Amperes)	Catalog Number
60 Cycles AC		
120	0.09	U01MN6
208	0.05	U02MN6
240	0.04	U03MN6
277	0.04	U15MN6
480	0.02	U04MN6
600	0.02	U06MN6
DC		
24	0.23	U07MN6
48	0.13	U09MN6
125	0.08	U11MN6
250	0.04	U13MN6

Bell Alarm Wire Identification (All With Three Leads)

Wire Markings	Wire Color	Switch Terminals or Contacts
C	White	C. – Common Terminal
A	Yellow	N.C. – Normally Closed Contact (Closed when circuit breaker is tripped)
B	Brown	N.O. – Normally Open Contact (Open when circuit breaker is tripped)

Auxiliary Switch Identification (All With Three Leads)

Wire Markings	Wire Color	Switch Terminals or Contacts
C1 or C2	White	C. – Common Terminal
B1 or B2	Red	N.C. – Normally Closed Contact (Closed when circuit breaker is tripped)
A1 or A2	Black	N.O. – Normally Open Contact (Open when circuit breaker is tripped)

Bell Alarm Mechanical and Electrical Check

- Use a buzzer or light indicator attached to switch leads A and C. With device in TRIPPED position, indicator light or buzzer should operate.
- Reset breaker to OFF indicator light or buzzer should turn off.
- Move breaker handle to ON indicator light or buzzer should remain off.

NOTE: Should the indicator not function properly during "check" procedure, inspect for incorrect installation or wiring.

Auxiliary and Bell Alarm Switch Kits

Catalog Number	Number of Auxiliary Switches	Ampere Rating of Switch				
		Volts AC			Volts DC	
		120	240	480	125	250
B00MN64	0	10	10	10	.5	.25
A01MN64B	1	10	10	10	.5	.25
A02MN64B	2	10	10	10	.5	.25
A01MN64	1	10	10	10	.5	.25
A02MN64	2	10	10	10	.5	.25

MD-Frame Time Current Curve

Types MD6, MXD6, HMD6, HMXD6, CMD6

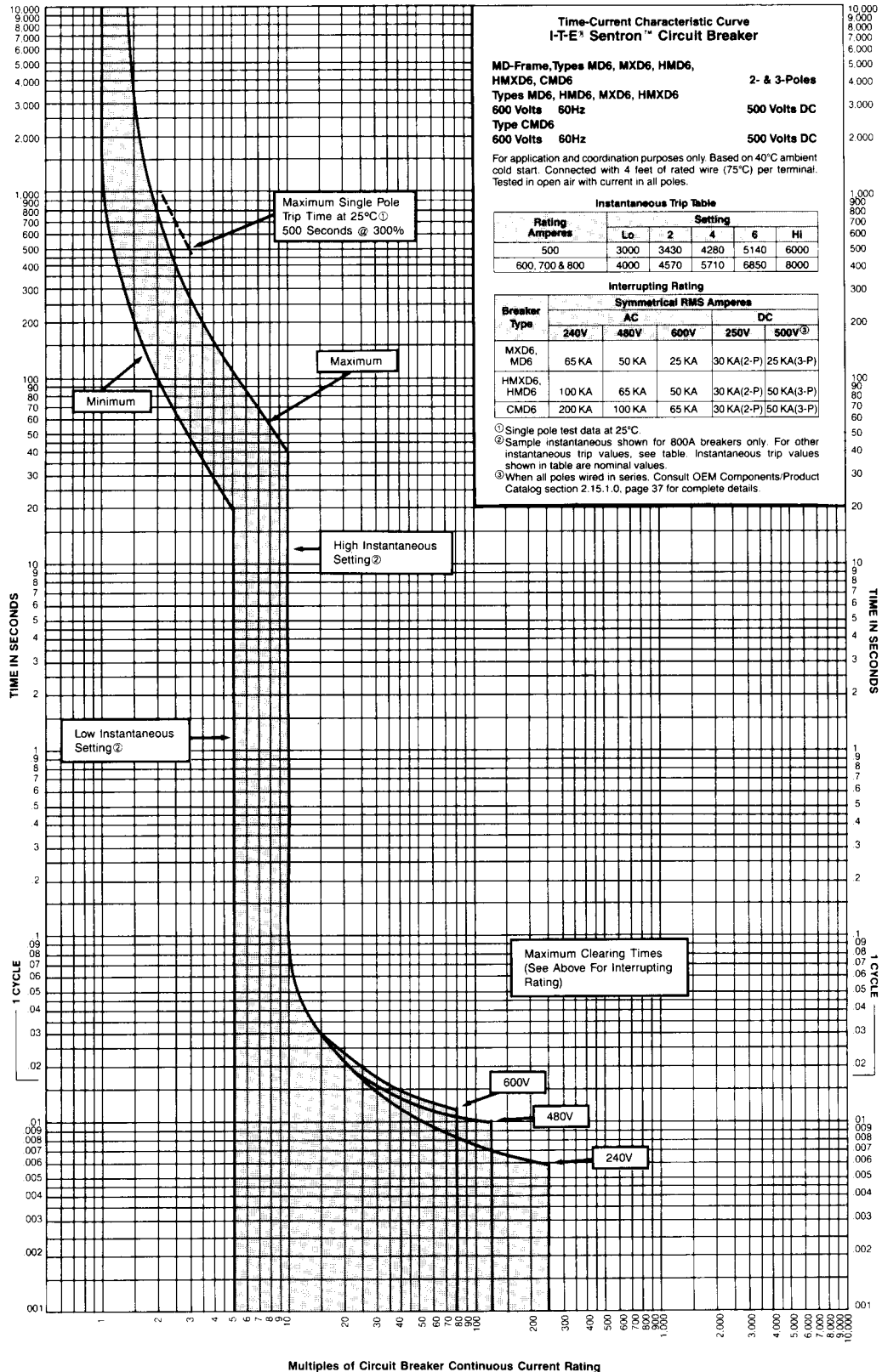

TD-7108

Multiples of Circuit Breaker Continuous Current Rating

ND-Frame Time Current Curve

Types ND6, NXD6, HND6, HNXD6, CND6

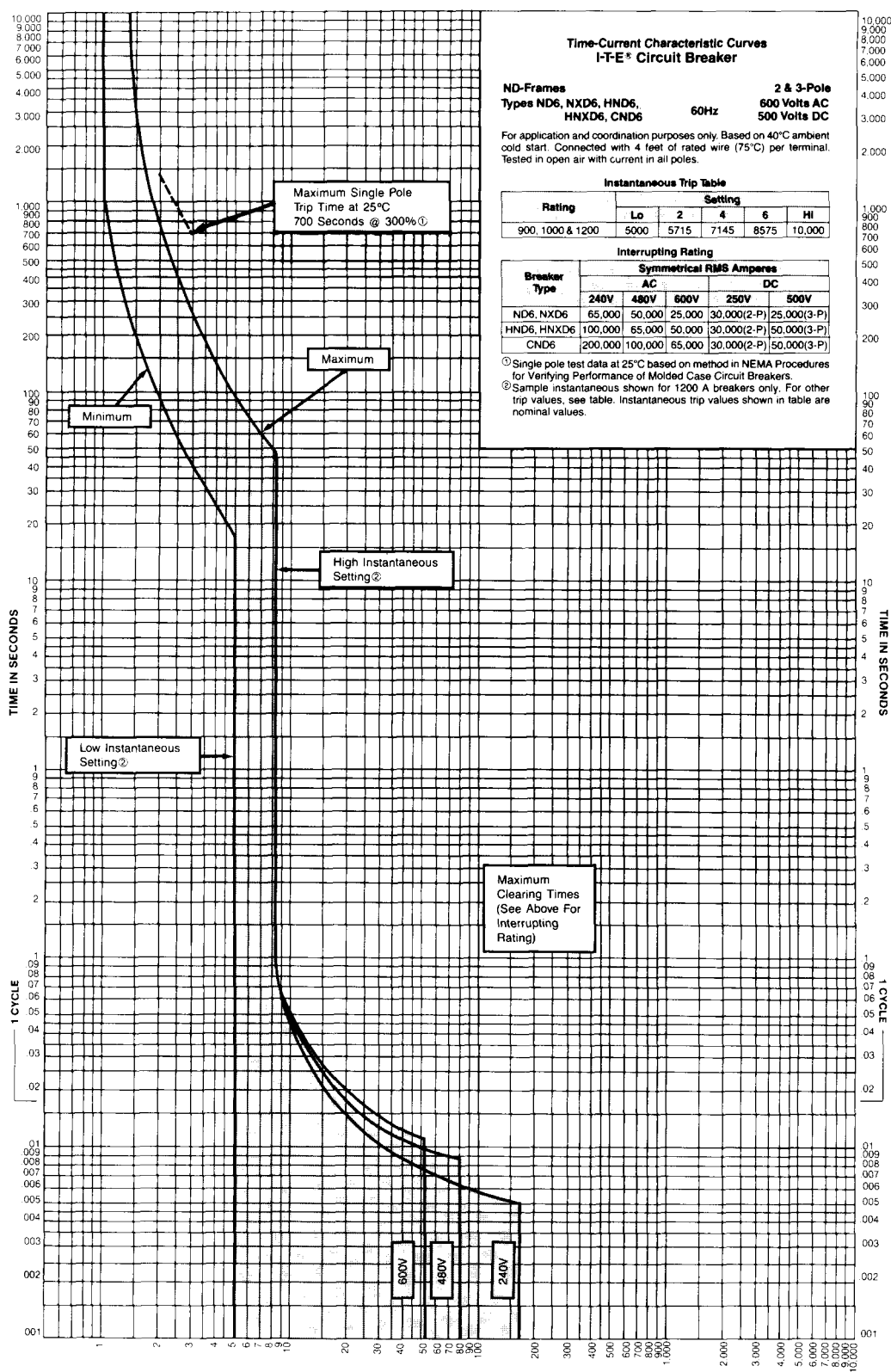

TD-7109

Multiples of Circuit Breaker Continuous Current Rating

Siemens Energy & Automation, Inc.
Power Distribution & Controls Division
3333 Old Milton Parkway
Alpharetta, GA 30005

For Nearest Sales Office
1-800-964-4114 or 800-241-4453
[www.sea.siemens.com/
sales/salesoffices.html](http://www.sea.siemens.com/sales/salesoffices.html)

For Product Information
www.sea.siemens.com/power/
