

Conflicto a titre de secret d'entreprise. Tous droits réservés.
 Conflicto como secreto industrial. Nos reservados todos los derechos.
 Comunicado como segredo empresarial. Reservados todos os direitos.

Weitergabe sowie Vervielfältigung dieser Unterlage, Verwertung und Mitteilung ihres Inhalts nicht gestattet, soweit nicht ausdrücklich zugestanden. Zuwiderhandlungen verpflichten zu Schadenersatz. Alle Rechte vorbehalten, insbesondere für den Fall der Patenterteilung oder Gd-Entragung.

The reproduction or use of this document or its contents is not permitted without express written authority. Offenders will be liable for damages. All rights, including rights created by patent grant or registration of a utility model or design, are reserved.

Copyright © Siemens AG 2005
 Copy-drawing do not make any manual changes

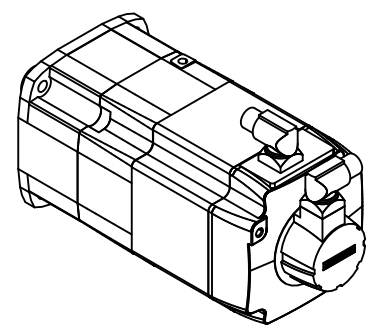
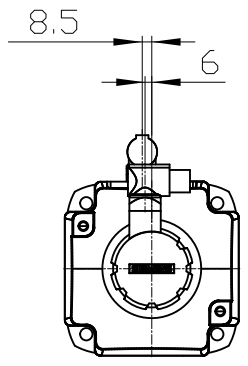

DIN 332-DR M12

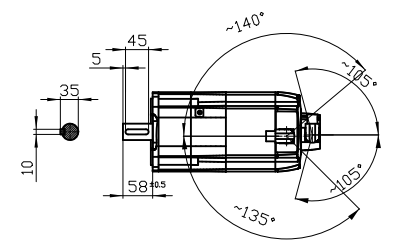
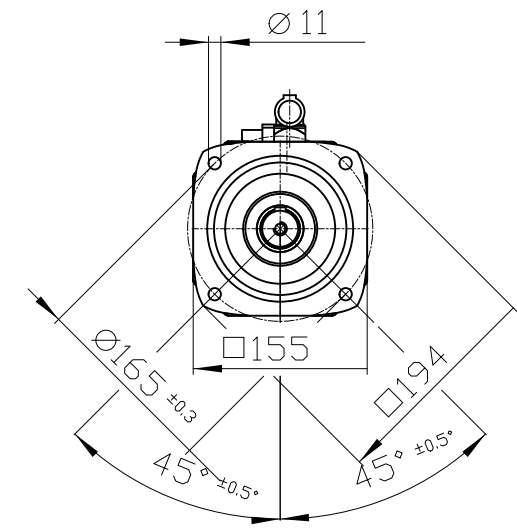
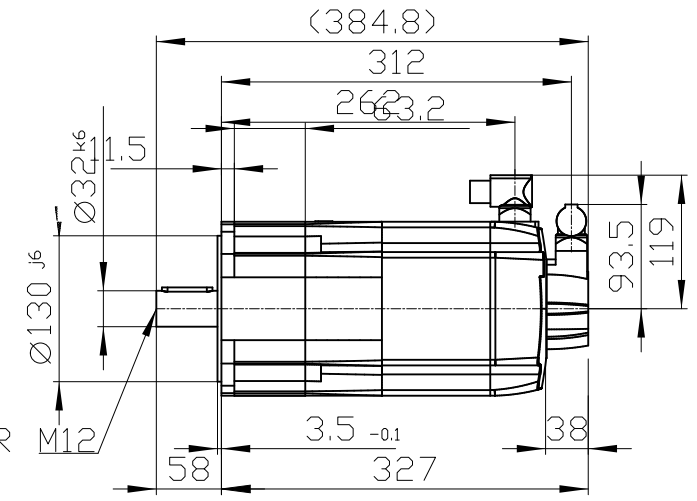

Connector size 1 = M23;
 6-pole for power and brake

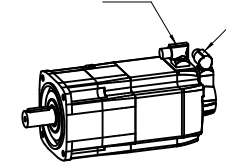

Connector size M23, 17-pole

		-
Unit	mm (in)	1FK7084-3BF74-1AB1
Date	2/4/20	
SIEMENS AG		-
		DT