

**SIEMENS**

Installation Manual

# SIMATIC NET

Rugged Multi Service Platforms

RUGGEDCOM RX1512

Edition

12/2019

<https://www.siemens.com>

# SIEMENS

## SIMATIC NET

### Rugged Multi Service Platforms RUGGEDCOM RX1512

#### Installation Manual

Preface	
Introduction	1
Installing the Device	2
Device Management	3
Modules	4
Technical Specifications	5
Certification	6

## Legal Information

### Warning Notice System

This manual contains notices you have to observe in order to ensure your personal safety, as well as to prevent damage to property. The notices referring to your personal safety are highlighted in the manual by a safety alert symbol, notices referring only to property damage have no safety alert symbol. These notices shown below are graded according to the degree of danger.

 <b>DANGER</b>
---

indicates that death or severe personal injury will result if proper precautions are not taken.
---

 <b>WARNING</b>
--

indicates that death or severe personal injury may result if proper precautions are not taken.
--

 <b>CAUTION</b>
--

indicates that minor personal injury can result if proper precautions are not taken.
--

<b>NOTICE</b>
---------------

indicates that property damage can result if proper precautions are not taken.
--

If more than one degree of danger is present, the warning notice representing the highest degree of danger will be used. A notice warning of injury to persons with a safety alert symbol may also include a warning relating to property damage.

### Qualified Personnel

The product/system described in this documentation may be operated only by **personnel qualified** for the specific task in accordance with the relevant documentation, in particular its warning notices and safety instructions. Qualified personnel are those who, based on their training and experience, are capable of identifying risks and avoiding potential hazards when working with these products/systems.

### Proper Use of Siemens Products

Note the following:

 <b>WARNING</b>
--

Siemens products may only be used for the applications described in the catalog and in the relevant technical documentation. If products and components from other manufacturers are used, these must be recommended or approved by Siemens. Proper transport, storage, installation, assembly, commissioning, operation and maintenance are required to ensure that the products operate safely and without any problems. The permissible ambient conditions must be complied with. The information in the relevant documentation must be observed.
--

### Trademarks

All names identified by ® are registered trademarks of Siemens AG. The remaining trademarks in this publication may be trademarks whose use by third parties for their own purposes could violate the rights of the owner.

### Disclaimer of Liability

We have reviewed the contents of this publication to ensure consistency with the hardware and software described. Since variance cannot be precluded entirely, we cannot guarantee full consistency. However, the information in this publication is reviewed regularly and any necessary corrections are included in subsequent editions.

# Table of Contents

<b>Preface</b> .....	<b>v</b>
Related Documents .....	v
Accessing Documentation .....	v
Disclaimer of Liability .....	v
Registered Trademarks .....	vi
Training .....	vi
Customer Support .....	vi
Contacting Siemens .....	vii
<b>1 Introduction</b> .....	<b>1</b>
1.1 Feature Highlights .....	1
1.2 Description .....	1
1.3 Required Tools and Materials .....	3
1.4 Decommissioning and Disposal .....	3
1.5 Cabling Recommendations .....	3
1.5.1 Protection On Twisted-Pair Data Ports .....	4
1.5.2 Gigabit Ethernet 1000Base-TX Cabling Recommendations .....	4
<b>2 Installing the Device</b> .....	<b>5</b>
2.1 General Procedure .....	6
2.2 Unpacking the Device .....	6
2.3 Mounting the Device .....	7
2.3.1 Mounting the Device on a DIN Rail .....	7
2.3.2 Mounting the Device to a Panel .....	8
2.4 Connecting the Failsafe Alarm Relay .....	8
2.5 Connecting Power .....	9
2.5.1 Connecting Low DC Power .....	10
2.5.2 Testing Dielectric Strength .....	12
<b>3 Device Management</b> .....	<b>15</b>
3.1 Connecting to the Device .....	15
3.2 Configuring the Device .....	16
3.3 Accessing the CompactFlash Card .....	16
<b>4 Modules</b> .....	<b>21</b>
4.1 Available Modules .....	21
4.2 Installing/Removing Line Modules .....	30
<b>5 Technical Specifications</b> .....	<b>33</b>
5.1 Power Supply Specifications .....	33

5.2	Failsafe Relay Specifications .....	33
5.3	Operating Environment .....	33
5.4	Mechanical Specifications .....	34
5.5	Dimension Drawings .....	34
<b>6</b>	<b>Certification .....</b>	<b>37</b>
6.1	Approvals .....	37
6.1.1	TÜV SÜD .....	37
6.1.2	European Union (EU) .....	37
6.1.3	FCC .....	39
6.1.4	FDA/CDRH .....	39
6.1.5	ISED .....	39
6.1.6	RoHS .....	39
6.1.7	Other Approvals .....	40
6.2	EMC and Environmental Type Tests .....	40

# Preface

This guide describes the RUGGEDCOM RX1512. It describes the major features of the device, installation, commissioning and important technical specifications.

It is intended for use by network technical support personnel who are responsible for the installation, commissioning and maintenance of the device. It is also recommended for use by network and system planners, system programmers, and line technicians.

## Related Documents

Other documents that may be of interest include:

- *RUGGEDCOM RX1512 CLI User Guide* [<https://support.industry.siemens.com/cs/ww/en/view/109481699>]
- *RUGGEDCOM RX1512 Web Interface User Guide* [<https://support.industry.siemens.com/cs/ww/en/view/109481700>]
- *RUGGEDCOM RX1512 Modules Catalog* [<https://support.industry.siemens.com/cs/ww/en/view/109747072>]

## Accessing Documentation

The latest user documentation for RUGGEDCOM RX1512 is available online at <https://support.industry.siemens.com>. To request or inquire about a user document, contact Siemens Customer Support.

## Disclaimer of Liability

Siemens has verified the contents of this document against the hardware and/or software described. However, deviations between the product and the documentation may exist.

Siemens shall not be liable for any errors or omissions contained herein or for consequential damages in connection with the furnishing, performance, or use of this material.

The information given in this document is reviewed regularly and any necessary corrections will be included in subsequent editions. We appreciate any suggested improvements. We reserve the right to make technical improvements without notice.

## Registered Trademarks

RUGGEDCOM™ and ROS™ are trademarks of Siemens AG.

Linux® is the registered trademark of Linus Torvalds in the United States and other countries.

The registered trademark Linux® is used pursuant to a sublicense from LMI, the exclusive licensee of Linus Torvalds, owner of the mark on a world-wide basis.

Other designations in this manual might be trademarks whose use by third parties for their own purposes would infringe the rights of the owner.

## Training

Siemens offers a wide range of educational services ranging from in-house training of standard courses on networking, Ethernet switches and routers, to on-site customized courses tailored to the customer's needs, experience and application.

Siemens' Educational Services team thrives on providing our customers with the essential practical skills to make sure users have the right knowledge and expertise to understand the various technologies associated with critical communications network infrastructure technologies.

Siemens' unique mix of IT/Telecommunications expertise combined with domain knowledge in the utility, transportation and industrial markets, allows Siemens to provide training specific to the customer's application.

For more information about training services and course availability, visit <https://www.siemens.com> or contact a Siemens Sales representative.

## Customer Support

Customer support is available 24 hours, 7 days a week for all Siemens customers. For technical support or general information, contact Siemens Customer Support through any of the following methods:



### Online

Visit <http://www.siemens.com/automation/support-request> to submit a Support Request (SR) or check on the status of an existing SR.

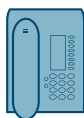

### Telephone

Call a local hotline center to submit a Support Request (SR). To locate a local hotline center, visit [https://w3.siemens.com/aspa\\_app/?lang=en](https://w3.siemens.com/aspa_app/?lang=en).



### Mobile App

Install the Industry Online Support app by Siemens AG on any Android, Apple iOS or Windows mobile device and be able to:

- Access Siemens' extensive library of support documentation, including FAQs and manuals

- Submit SRs or check on the status of an existing SR
- Contact a local Siemens representative from Sales, Technical Support, Training, etc.
- Ask questions or share knowledge with fellow Siemens customers and the support community

## Contacting Siemens

<b>Address</b>	Siemens AG Industry Sector 300 Applewood Crescent Concord, Ontario Canada, L4K 5C7
<b>Telephone</b>	Toll-free: 1 888 264 0006 Tel: +1 905 856 5288 Fax: +1 905 856 1995
<b>E-Mail</b>	<a href="mailto:ruggedcom.info.i-ia@siemens.com">ruggedcom.info.i-ia@siemens.com</a>
<b>Web</b>	<a href="https://www.siemens.com">https://www.siemens.com</a>



## Introduction

The RUGGEDCOM RX1512 is a cost-efficient, rugged Layer 3 switch and router. The RUGGEDCOM RX1512's modular and field replaceable platform can be equipped with WAN, serial, and Ethernet options, making it ideally suited for electric power utilities, the industrial plant floor, and traffic control systems. The appliance's compact form factor makes it ideal for pole mount applications or installation in restricted spaces.

The RUGGEDCOM RX1512 is designed to provide a high level of immunity to electromagnetic interference (EMI) and heavy electrical surges typical of the harsh environments found in many industrial applications. An operating temperature range of -40 to 85 °C (-40 to 185 °F) allows the RUGGEDCOM RX1512 to be placed in almost any location.

### 1.1 Feature Highlights

#### Reliability in Harsh Environments

- Immunity to EMI and high voltage electrical transients
- -40 to 85 °C (-40 to 185 °F) operating temperature (no fans)
- Failsafe output relay for critical failure or error alarming

#### Universal Power Supply Options

- Fully integrated power supply (no external adapter)
- Input voltage range: 11-72 VDC
- CSA/UL 60950-1 safety approved to 85 °C (185 °F)

#### Physical Ports

- Field replaceable line modules
- Up to 12 100Base-FX ports
- Up to 12 10/100Base-TX ports
- Up to 6 10Base-FL/100Base-SX ports
- Up to 4 Gigabit Ethernet ports
- Up to 12 serial ports
- Up to 4 T1/E1 RJ48C ports or 2 E1 BNC ports
- Up to 2 DDS (Digital Data Services) ports
- Up to 8 active cellular data interfaces

### 1.2 Description

The RUGGEDCOM RX1512 features various ports, controls and indicator LEDs on the front panel for connecting, configuring and troubleshooting the device.

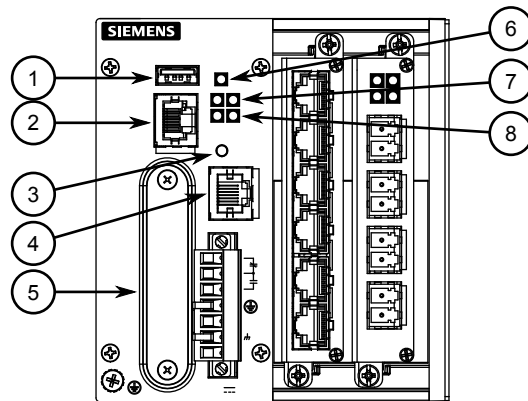

- ① Utility USB Port
- ② RS232 Serial Console Port (RJ45)
- ③ Lamp Test/Alarm Cut-Off (LT/ACO) Button
- ④ Management Port
- ⑤ Compact Flash Card Port
- ⑥ Alarm Indicator LED
- ⑦ Power Status LEDs
- ⑧ Port Status LEDs

Figure 1.1 RUGGEDCOM RX1512

<b>Management Port</b>	This 10/100Base-T Ethernet port is used for system management that is out-of-band from the switch fabric.
<b>RS-232 Serial Console Port</b>	The serial console port is for interfacing directly with the device and accessing initial management functions. For information about connecting to the device via the serial console port, refer to " <a href="#">Connecting to the Device (Page 15)</a> ".
<b>Utility USB Port</b>	Use the USB port to upgrade the RUGGEDCOM RX1512 software or install files, such as configuration files and feature key files. For more information, refer to the <i>RUGGEDCOM RX1512 User Guide</i> for the RUGGEDCOM RX1512.
<b>Lamp Test/Alarm Cut-Off (LT/ACO) Button</b>	This button performs two functions: <ul style="list-style-type: none"> <li>• Press and hold this button to test all indicator LEDs</li> <li>• Press and release this button to acknowledge an active alarm</li> </ul>
<b>Power Status LEDs</b>	Indicates the status of the power modules. <ul style="list-style-type: none"> <li>• I = The power module is receiving power</li> <li>• O = The power module is supplying power</li> </ul>
<b>Port Status LEDs</b>	Indicates when ports are active. <ul style="list-style-type: none"> <li>• Green = OK</li> <li>• Orange = Warning alert</li> <li>• Red = Configuration error</li> </ul>
<b>Alarm Indicator LED</b>	Indicates when an alarm condition exists. <ul style="list-style-type: none"> <li>• Green = Alarms cleared/acknowledged</li> <li>• Red = Alarm</li> </ul>
<b>Compact Flash Card Port</b>	Houses the CompactFlash (CF) card that contains active and back-up installations of RUGGEDCOM RUGGEDCOM RX1512, along with

the configuration database and other system data. For more information, refer to "[Accessing the CompactFlash Card \(Page 16\)](#)".

## 1.3 Required Tools and Materials

The following tools and materials are required to install the RUGGEDCOM RX1512:

Tools/Materials	Purpose
AC/DC power cord (16 AWG)	For connecting power to the device.
Lightning protector	For protecting the device from harmful electrical strikes.
Shielded coaxial cables	For connecting the device to antennas and an Ethernet network.
SIM Card(s) provided by the network carrier	For accessing a network carrier's cellular network. Required only if a cellular modem module is equipped.
Flathead screwdriver	For mounting the device to a DIN rail.
Phillips screwdriver	For mounting the device to a panel.
4 x #6-32 screws	For mounting the device to a panel.
Braided or equivalent ground wire	For grounding the device to safety Earth.

## 1.4 Decommissioning and Disposal

Proper decommissioning and disposal of this device is important to prevent malicious users from obtaining proprietary information and to protect the environment.

### Decommissioning

This device may include sensitive, proprietary data. Before taking the device out of service, either permanently or for maintenance by a third-party, make sure it has been fully decommissioned.

For more information, refer to the associated *User Guide*.

### Recycling and Disposal

For environmentally friendly recycling and disposal of this device and related accessories, contact a facility certified to dispose of waste electrical and electronic equipment. Recycling and disposal must be done in accordance with local regulations.

## 1.5 Cabling Recommendations

Siemens recommends using SIMATIC NET industrial Ethernet shielded cables for all Ethernet ports.

### 1.5.1 Protection On Twisted-Pair Data Ports

All copper Ethernet ports on RUGGEDCOM products include transient suppression circuitry to protect against damage from electrical transients and conform with IEC 61850-3 and IEEE 1613 Class 1 standards. This means that during a transient electrical event, communications errors or interruptions may occur, but recovery is automatic.

Siemens also does not recommend using copper Ethernet ports to interface with devices in the field across distances that could produce high levels of ground potential rise (i.e. greater than 2500 V), during line-to-ground fault conditions.

### 1.5.2 Gigabit Ethernet 1000Base-TX Cabling Recommendations

The IEEE 802.3ab Gigabit Ethernet standard defines 1000 Mbit/s Ethernet communications over distances of up to 100 m (328 ft) using all 4 pairs in category 5 (or higher) balanced, unshielded twisted-pair cabling. For wiring guidelines, system designers and integrators should refer to the Telecommunications Industry Association (TIA) TIA/EIA-568-A wiring standard that characterizes minimum cabling performance specifications required for proper Gigabit Ethernet operation. For reliable, error-free data communication, new and pre-existing communication paths should be verified for TIA/EIA-568-A compliance.

The following table summarizes the relevant cabling standards:

Cabling Category	1000Base-TX Compliant	Required Action
< 5	No	New wiring infrastructure required.
5	Yes	Verify TIA/EIA-568-A compliance.
5e	Yes	No action required. New installations should be designed with Category 5e or higher.
6	Yes	No action required.
> 6	Yes	Connector and wiring standards to be determined.

Follow these recommendations for copper data cabling in high electrical noise environments:

- Data cable lengths should be as short as possible, preferably 3 m (10 ft) in length. Copper data cables should not be used for inter-building communications.
- Power and data cables should not be run in parallel for long distances, and should be installed in separate conduits. Power and data cables should intersect at 90° angles when necessary to reduce inductive coupling.

## Installing the Device

This chapter describes how to install the device, including mounting the device, connecting power, and connecting the device to the network.

### **DANGER**

**Electrocution hazard – risk of serious personal injury and/or damage to equipment.**

Before performing any maintenance tasks, make sure all power to the device has been disconnected and wait approximately two minutes for any remaining energy to dissipate.

### **WARNING**

**Radiation hazard – risk of serious personal injury.**

This product contains a laser system and is classified as a *CLASS 1 LASER PRODUCT*. Use of controls or adjustments or performance of procedures other than those specified herein may result in hazardous radiation exposure.

### **WARNING**

**Radiation hazard – risk of Radio Frequency (RF) exposure.**

This device is compliant with the requirements set forth in FCC 47 CFR, section 1.1307, addressing Radio Frequency (RF) exposure from radio frequency base stations, as defined in [FCC OET Bulletin 65 \[http://transition.fcc.gov/Bureaus/Engineering\\_Technology/Documents/bulletins/oet65/oet65.pdf\]](http://transition.fcc.gov/Bureaus/Engineering_Technology/Documents/bulletins/oet65/oet65.pdf). The emitted radiation should be as little as possible. To achieve minimum RF exposure, install the device when it is configured not to transmit and set it to operational mode remotely, rather than having a technician enable transmission on-site. For maintenance of the base station, or other operations which require RF exposure, the exposure should be minimized in time and according to the regulations set forth by the country of installation or the Federal Communications Commission (FCC).

### **NOTICE**

This product contains no user-serviceable parts. Attempted service by unauthorized personnel shall render all warranties null and void.

Changes or modifications not expressly approved by Siemens AG could invalidate specifications, test results, and agency approvals, and void the user's authority to operate the equipment.

<b>NOTICE</b>
This product should be installed in a <i>restricted access location</i> where access can only be gained by authorized personnel who have been informed of the restrictions and any precautions that must be taken. Access must only be possible through the use of a tool, lock and key, or other means of security, and controlled by the authority responsible for the location.

## 2.1 General Procedure

The general procedure for installing the device is as follows:

<b>NOTICE</b>
The user is responsible for the operating environment of the device, including maintaining the integrity of all protective conductor connections and checking equipment ratings. Make sure to review all operating and installation instructions before commissioning or performing maintenance on the device.

1. Review the relevant certification information for any regulatory requirements. For more information, refer to "[Approvals \(Page 37\)](#)".
2. Review the *RUGGEDCOM RX1500 Series Modules Catalog* for special installation or regulatory requirements related to the modules installed in the device. In the case of cellular modem line modules, this includes antenna installation and regulatory requirements.
3. Mount the device.
4. Connect the failsafe alarm relay.
5. Connect power to the device and ground the device to safety Earth.
6. Connect the device to the network.
7. Configure the device.

## 2.2 Unpacking the Device

When unpacking the device, do the following:

1. Inspect the package for damage before opening it.
2. Visually inspect each item in the package for any physical damage.
3. Verify all items are included.

<b>NOTICE</b>
If any item is missing or damaged, contact Siemens for assistance.

## 2.3 Mounting the Device

The RUGGEDCOM RX1512 is designed for maximum mounting and display flexibility. It can be equipped with connectors that allow it to be installed in a 35 mm (1.4 in) DIN rail, or directly on a panel.

### NOTICE

Heat generated by the device is channeled outwards from the enclosure. As such, it is recommended that 2.5 cm (1 in) of space be maintained on all open sides of the device to allow for some convective airflow.

Forced airflow is not required. However, any increase in airflow will result in a reduction of ambient temperature and improve the long-term reliability of all equipment mounted in the rack space.

### Note

For detailed dimensions of the device with either DIN rail or panel hardware installed, refer to "[Dimension Drawings \(Page 34\)](#)".

### 2.3.1 Mounting the Device on a DIN Rail

For DIN rail installations, the RUGGEDCOM RX1512 can be equipped with panel/DIN rail adapters pre-installed on each side of the chassis. The adapters allow the device to be slid onto a standard 35 mm (1.4 in) DIN rail.

To mount the device to a DIN rail, do the following:

1. Align the adapters with the DIN rails and slide the device into place.

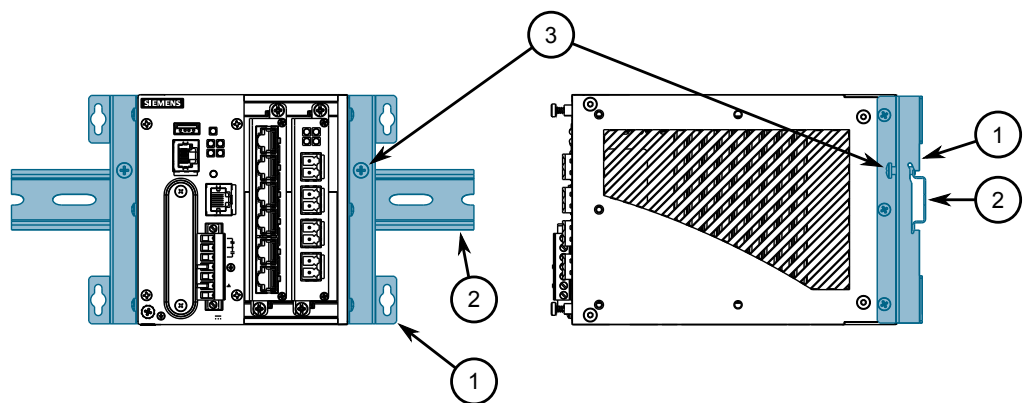

- ① Panel/DIN Rail Adapter
- ② DIN Rail
- ③ Screw

Figure 2.1 DIN Rail Mounting

2. Install one of the supplied screws on either side of the device to secure the adapters to the DIN rails.

### 2.3.2 Mounting the Device to a Panel

For panel installations, the RUGGEDCOM RX1512 can be equipped with panel/DIN rail adapters pre-installed on each side of the chassis. The adapters allow the device to be attached to a panel using screws.

To mount the device to a panel, do the following:

1. Place the device against the panel and mark the mounting holes on the panel.

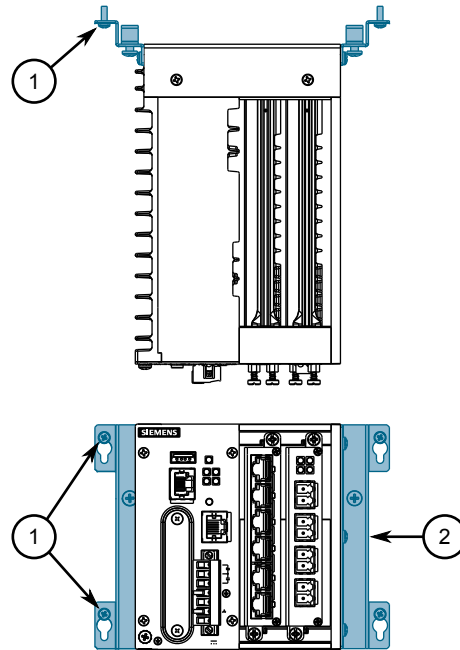

- ① Screw
- ② Panel/DIN Rail Adapter

Figure 2.2 Panel Mounting

2. Prepare the mounting holes
3. Align the device with the mounting holes and secure it to the panel.

### 2.4 Connecting the Failsafe Alarm Relay

The failsafe relay can be configured to latch based on alarm conditions. The NO (Normally Open) contact is closed when the unit is powered and there are no active alarms. If the device is not powered or if an active alarm is configured, the relay opens the NO contact and closes the NC (Normally Closed) contact.

#### Note

Control of the failsafe relay output is configurable through RUGGEDCOM RX1512. One common application for this relay is to signal an alarm if a power failure oc-

curs. For more information, refer to the *RUGGEDCOM RX1512 User Guide* for the RUGGEDCOM RX1512.

The following shows the proper relay connections.

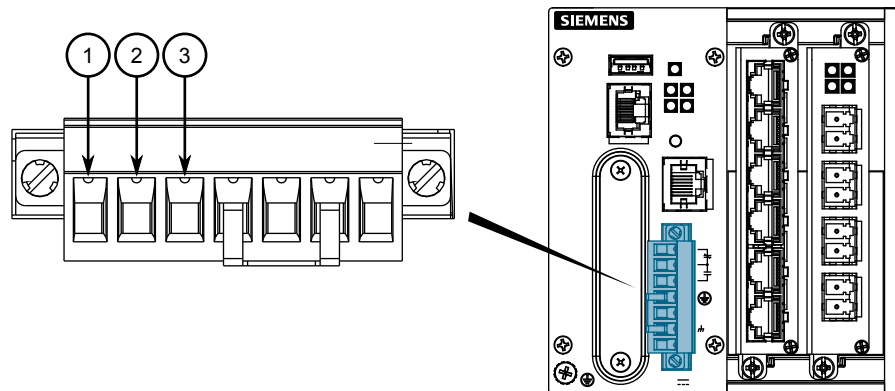

- ① Normally Closed
- ② Common
- ③ Normally Open

Figure 2.3 Failsafe Alarm Relay Wiring

## 2.5 Connecting Power

The RUGGEDCOM RX1512 supports a single low DC power source.

### **⚠ DANGER**

#### **Electrocution hazard – risk of serious personal injury or death**

Make sure all power sources are off before servicing the power module terminals.  
Make sure the power source is off before servicing the power terminal.

### **NOTICE**

- Use minimum #16 gage copper wiring when connecting terminal blocks.
- The maximum wire length between the terminal block and power source must not exceed 6 m (20 ft) for 24 V power supplies or 18 m (60 ft) for 48 V power supplies.
- For 125/230 VAC rated equipment, an appropriately rated AC circuit breaker must be installed.
- For 125/250 VDC rated equipment, an appropriately rated DC circuit breaker must be installed.
- Equipment must be installed according to applicable local wiring codes and standards.

## 2.5.1 Connecting Low DC Power

To connect a low DC power supply to the device, do the following:

 <b>CAUTION</b>
--

<b>Electrical hazard – risk of damage to equipment</b>
--

Do not connect AC power cables to a 12, 24 or 48 VDC power supply terminal block. Damage to the power supply may occur.
---

 <b>CAUTION</b>
--

<b>Electrical hazard – risk of damage to equipment</b>
--

In normal operation, the jumper between the chassis ground and surge ground terminals must be installed for proper operation. Damage to the device may occur otherwise. Removing the jumper may also void the warranty.
---

---

**Note**

The RUGGEDCOM RX1512 works with both positive VDC power supplies and negative VDC power supplies.

---

**Note**

For information about how to safely test the dielectric strength of the device, refer to ["Testing Dielectric Strength \(Page 12\)"](#).

---

1. Connect the power supply terminal block to the device.

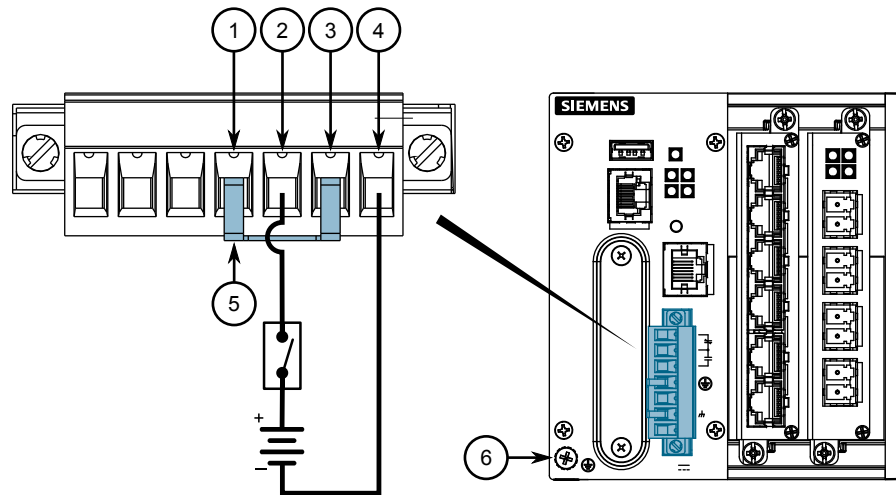

- ① Surge Ground Terminal
- ② Positive (+) Terminal
- ③ Chassis Ground Terminal
- ④ Negative (-) Terminal
- ⑤ Jumper
- ⑥ Chassis Ground Connection

Figure 2.4 DC Terminal Block Wiring for Positive VDC Power Supplies

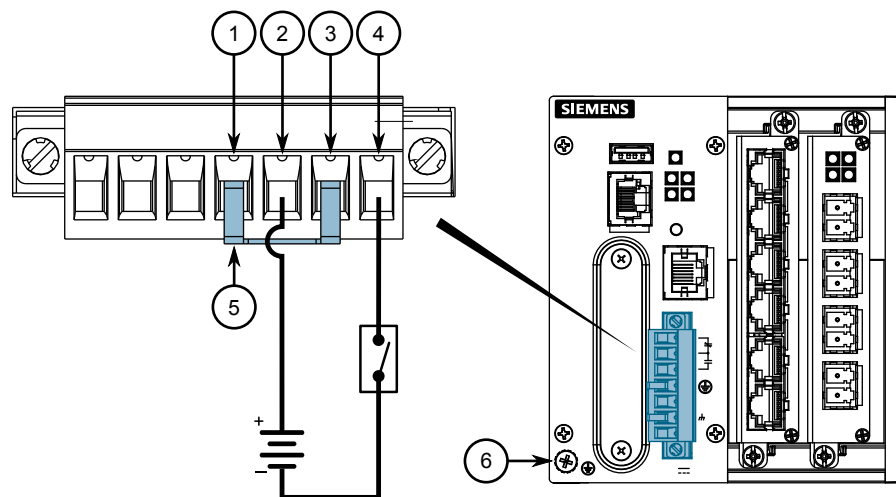

- ① Surge Ground Terminal
- ② Positive (+) Terminal
- ③ Chassis Ground Terminal
- ④ Negative (-) Terminal
- ⑤ Jumper
- ⑥ Chassis Ground Connection

Figure 2.5 DC Terminal Block Wiring for Negative VDC Power Supplies

2. Connect the positive wire from the power source to the positive (+) terminal on the terminal block.
3. Connect the negative wire from the power source to the negative (-) terminal on the terminal block.
4. Install a jumper between the surge ground terminal and chassis ground terminal. The surge ground terminal is used as the ground conductor for all surge and transient suppression circuitry internal to the unit.
5. Using a #10 ring lug and #10-32 screw, secure a ground wire (or bond point) to the chassis ground connection on the device. Make sure the lug is tightened to 1.1 N·m (9.5 lbf·in).

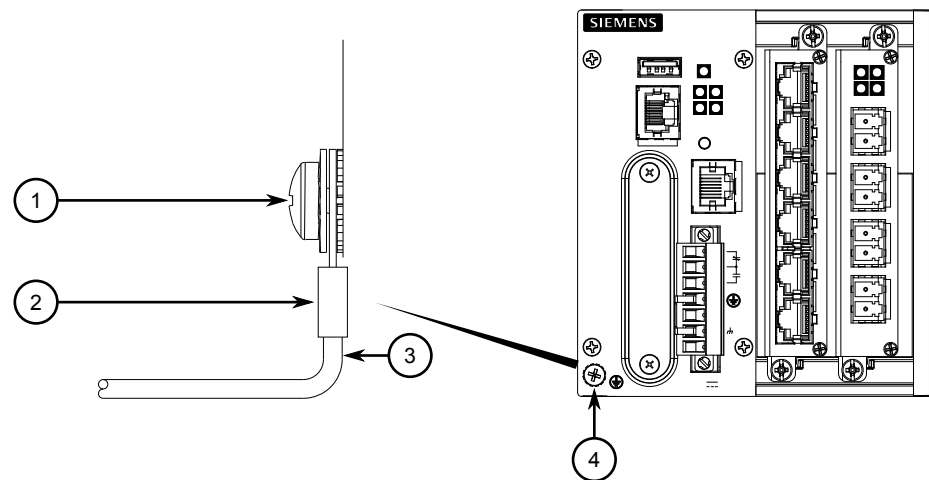

- ① #10 Ring Lug
- ② #10-32 Screw
- ③ Connection from External Power Source
- ④ Chassis Ground Connection

Figure 2.6 Chassis Ground Connection

6. Install the safety cover over the terminal block. **This is mandatory for 48 VDC and -48 VDC power supplies.**

## 2.5.2 Testing Dielectric Strength

Before performing any dielectric strength or HIPOT (High Potential) testing on the RUGGEDCOM RX1512 in the field, do the following:

### NOTICE

In normal operation, the jumper between the chassis ground and surge ground terminals must be installed for proper operation. Removing the jumper may void the warranty.

**⚠ CAUTION****Electrical hazard – risk of damage to equipment**

Before testing the dielectric strength (HIPOT), remove the metal jumper. Damage to equipment may occur.

1. Remove the metal jumper that connects surge ground terminal and the chassis ground terminal. This metal jumper connects transient suppression circuitry to chassis ground and must be removed in order to avoid damage to transient suppression circuitry during testing.

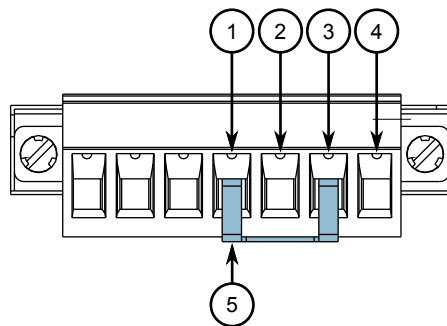

- ① Surge Ground Terminal
- ② Positive (+) Terminal
- ③ Chassis Ground Terminal
- ④ Negative (-) Terminal
- ⑤ Jumper
- ⑥ Chassis Ground Connection

Figure 2.7 Jumper

2. Connect one terminal from the HIPOT tester to the positive terminal and the negative terminal. Connect the second terminal of the HIPOT tester to chassis ground terminal. Do not connect the HIPOT tester to surge ground terminal.
3. Following the test, install the metal jumper between the surge ground terminal and the chassis ground terminal.



## Device Management

This section describes how to connect to and manage the device.

### 3.1 Connecting to the Device

The following describes the various methods for accessing the RUGGEDCOM RX1512 console and Web interfaces on the device. For more detailed instructions, refer to the *RUGGEDCOM ROX User Guide* for the RUGGEDCOM RX1512.

#### Serial Console and Management Ports

Connect a workstation directly to the serial console or management ports to access the boot-time control and RUGGEDCOM RX1512 interfaces. The serial console port provides access to RUGGEDCOM RX1512's console interface, while the management port provides access to RUGGEDCOM RX1512's console and Web interfaces.

#### NOTICE

The serial console and management (MGMT) ports are intended to be used only as temporary connections during initial configuration or troubleshooting.

Connection to the console port is made using an RJ-45-to-DB9 console cable. The following is the pin-out for the console port:

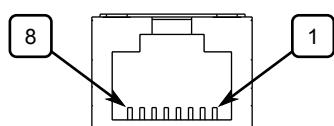

Figure 3.1 RJ-45 Console Port Pin Configuration

Pin		Name	Description
RJ-45 Male	DB9 Female		
1	6	DSR <sup>a</sup>	Data Set Ready
2	1	Reserved	(Do Not Connect)
3	4	DTR <sup>a</sup>	>Data Terminal Ready
4	5	GND	Signal Ground
5	2	RxD	Receive Data (to DTE)
6	3	TxD	Transmit Data (from DTE)
7	8	CTS <sup>b</sup>	Clear to Send
8	7	RTS <sup>b</sup>	>Read to Send
	9	RI <sup>c</sup>	Ring Indicator

- <sup>a</sup> The DSR, DCD and DTR pins are connected together internally.  
<sup>b</sup> The CTS and RTS pins are connected together internally.  
<sup>c</sup> RI is not connected.

For information about how to connect to the device via the serial console port, refer to the *RUGGEDCOM ROX CLI User Guide* for the RUGGEDCOM RX1512.

For information about how to connect to the device via the management port, refer to either the *RUGGEDCOM ROX Web Interface User Guide* or the *RUGGEDCOM ROX CLI User Guide* for the RUGGEDCOM RX1512.

The management port is a 10/100Base-TX copper Ethernet port with an RJ-45 connector. The following is the pin-out for the management port:

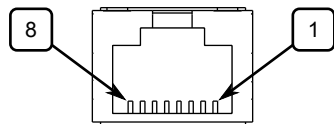

Figure 3.2 RJ-45 Management Port

Pin	Name	Description
1	RX+	Receive Data+
2	RX-	Receive Data-
3	TX+	Transmit Data+
4		Reserved (Do Not Connect)
5		Reserved (Do Not Connect)
6	TX-	Transmit Data-
7		Reserved (Do Not Connect)
8		Reserved (Do Not Connect)

### Communication Ports

Connect any of the available Ethernet ports on the device to a management switch and access the RUGGEDCOM RX1512 console and Web interfaces via the device's IP address. The factory default IP address for the RUGGEDCOM RX1512 is <https://192.168.0.2>.

For more information about available ports, refer to "[Modules \(Page 21\)](#)".

---

#### Note

Single-mode fiber ports only support Ultra Physical Contact (UPC) cable connectors.

---

## 3.2 Configuring the Device

Once the device is installed and connected to the network, it must be configured. All configuration management is done via the RUGGEDCOM RX1512 interface. For more information about configuring the device, refer to the *RUGGEDCOM RX1512 User Guide* associated with the installed software release.

## 3.3 Accessing the CompactFlash Card

The RUGGEDCOM RX1512 features a removable CompactFlash (CF) card that stores configuration files, firmware (active and backup versions), file-based feature keys and other system files.

**⚠ CAUTION**

Configuration hazard – risk of data corruption/loss. Do not remove or insert the CF card when the device is powered on.

The CF card should only be removed in the following scenarios:

- The chassis is defective (with the exception of power and media modules)
- The CF card is deemed defective or corrupt
- The device is rendered non-functional due to a serious configuration error, data corruption, or hardware fault

**⚠ CAUTION**

Configuration hazard – risk of data corruption/loss. The following will void the warranty and potentially result in configuration data corruption/loss:

- Using a CF card not approved by Siemens for use with this device
- Removing the CF card in any scenario other than those described in this section

**Inserting the CF card**

To insert the CF card into the device, do the following:

**NOTICE**

The device should only be powered on when the CF card is present.

1. Make sure the device is powered down.
2. Remove the CF card access panel.

### 3.3 Accessing the CompactFlash Card

3. Insert the CF card into the slot until it is fully seated.

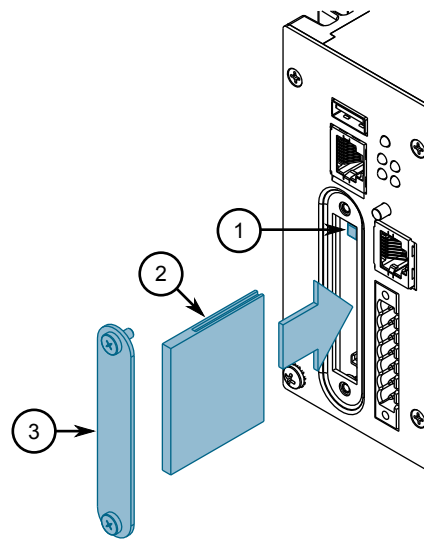

- ① CompactFlash Card
- ② Access Panel

Figure 3.3 Inserting the CF Card

4. Secure the CF card access panel to the chassis.

#### Removing the CF card

To remove the CF card from the device, do the following:

1. Make sure the device is powered down.

2. Remove the CF card access panel.

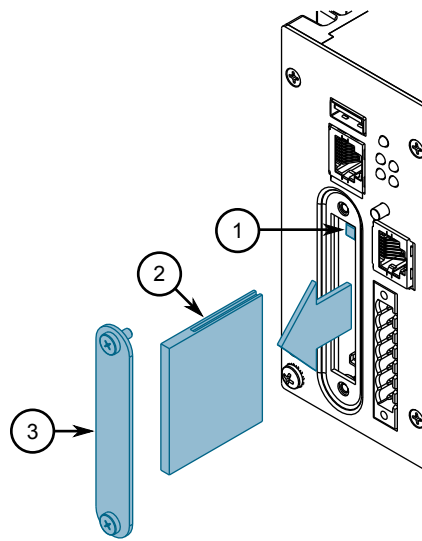

- ① Ejector Button
- ② CompactFlash Card
- ③ Access Panel

Figure 3.4 Removing the CF Card

3. Press the ejector button to the left of the CF card and then pull the card out.
4. Secure the CF card access panel to the chassis.



## Modules

The RUGGEDCOM RX1512 features slots for up to two field-replaceable line modules, which can be used to expand and customize the capabilities of the device to suit specific applications. A variety of modules are available, each featuring a specific type of communication port: copper Ethernet, fiber optic Ethernet, SFP, WAN, cellular modem and DDS. The RUGGEDCOM APE (Application Processing Engine) line module, a utility-grade computing platform for running third-party applications directly from within the RUGGEDCOM RX1512, is also available.

Modules can be installed in any one of the available slots in the device chassis.

Use the RUGGEDCOM RX1512 software to determine which ports are equipped on the device. For more information, refer to the *RUGGEDCOM RX1512 User Guide* for the device.

---

### Note

Only one T1/E1 WAN module or up to two DDS modules are supported.

---

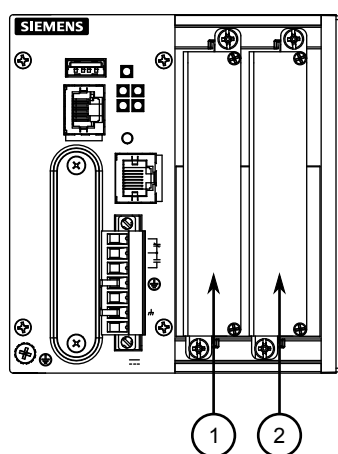

- ① Slot 1
- ② Slot 2

Figure 4.1 Available Chassis Slots

### 4.1 Available Modules

The following is a list of all power and line modules available for use in the RUGGEDCOM RX1512. For more information about individual modules, refer to the

[RUGGEDCOM RX1500 Series Modules Catalog \[https://support.industry.siemens.com/cs/cal/en/view/109747072\]](https://support.industry.siemens.com/cs/cal/en/view/109747072).

**Copper Ethernet Modules**

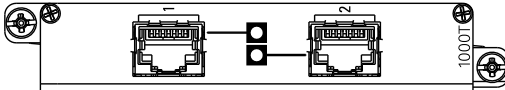
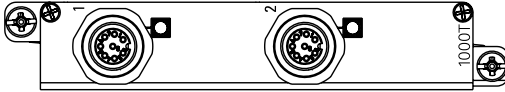
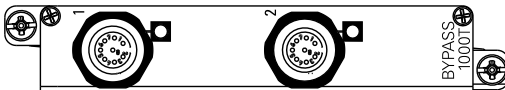
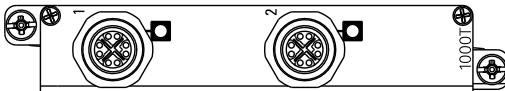
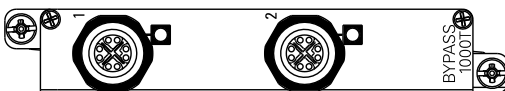
<p><b>RUGGEDCOM RX1500PN LM CG01</b></p> 	<p><b>Specifications</b></p> <p>Ports: 2            Speed: 1000 Mbps            Interface: TX            Port Type: RJ45            Distance: 100 m (328 ft)</p>	<p><b>Article Numbers</b></p> <p>6GK6015-0AL20-0FC0 (Standard)            6GK6015-0AL20-0FC1 (Conformal Coated)</p>
<p><b>RUGGEDCOM RX1500PN LM CG03</b></p> 	<p><b>Specifications</b></p> <p>Ports: 2            Speed: 1000 Mbps            Interface: TX            Port Type: M12 (8-Pin, A-Coded)            Distance: 100 m (328 ft)</p>	<p><b>Article Numbers</b></p> <p>6GK6015-0AL20-0PB0 (Standard)            6GK6015-0AL20-0PB1 (Conformal Coated)</p>
<p><b>RUGGEDCOM RX1500PN LM CG03B</b></p> 	<p><b>Specifications</b></p> <p>Ports: 2            Speed: 1000 Mbps            Interface: TX            Port Type: M12 (8-Pin, A-Coded, Controlled Bypass)            Distance: 100 m (328 ft)</p>	<p><b>Article Numbers</b></p> <p>6GK6015-0AL20-0PE0 (Standard)            6GK6015-0AL20-0PE1 (Conformal Coated)</p>
<p><b>RUGGEDCOM RX1500PN LM X CG04</b></p> 	<p><b>Specifications</b></p> <p>Ports: 2            Speed: 1000 Mbps            Interface: TX            Port Type: M12 (8-pin, X-Coded)            Distance: 100 m (328 ft)</p>	<p><b>Article Numbers</b></p> <p>6GK6015-0AL20-0PH0 (Standard)            6GK6015-0AL20-0PH1 (Conformal Coated)</p>
<p><b>RUGGEDCOM RX1500PN LM X CG04B</b></p> 	<p><b>Specifications</b></p> <p>Ports: 2            Speed: 1000 Mbps            Interface: TX            Port Type: M12 (8-pin, X-Coded, Controlled Bypass)            Distance: 100 m (328 ft)</p>	<p><b>Article Numbers</b></p> <p>6GK6015-0AL20-0PJ0 (Standard)            6GK6015-0AL20-0PJ1 (Conformal Coated)</p>
<p><b>RUGGEDCOM RX1500PN LM 4TX03</b></p>	<p><b>Specifications</b></p> <p>Ports: 4            Speed: 100 Mbps            Interface: TX</p>	<p><b>Article Numbers</b></p> <p>6GK6015-0AL20-0PC0 (Standard)</p>

4.1 Available Modules

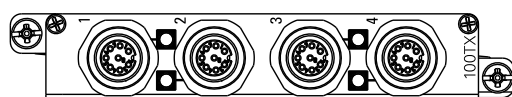

Port Type: M12 (4-Pin, A-Coded)  
 Distance: 100 m (328 ft)  
 6GK6015-0AL20-0PC1 (Conformal Coated)

**RUGGEDCOM RX1500PN LM 4TX03B**

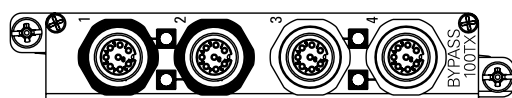

Specifications	Article Numbers
Ports: 4	6GK6015-0AL20-0PF0 (Standard)
Speed: 100 Mbps	6GK6015-0AL20-0PF1 (Conformal Coated)
Interface: TX	
Port Type: M12 (8-Pin, A-Coded, Controlled Bypass)	
Distance: 100 m (328 ft)	

**RUGGEDCOM RX1500PN LM 4TX04**

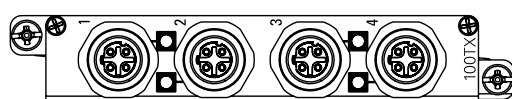

Specifications	Article Numbers
Ports: 4	6GK6015-0AL20-0PDO (Standard)
Speed: 100 Mbps	6GK6015-0AL20-0PD1 (Conformal Coated)
Interface: TX	
Port Type: M12 (4-Pin, D-Coded)	
Distance: 100 m (328 ft)	

**RUGGEDCOM RX1500PN LM 4TX04B**

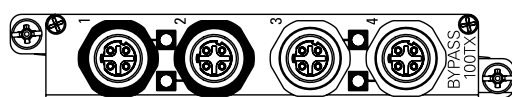

Specifications	Article Numbers
Ports: 4	6GK6015-0AL20-0PG0 (Standard)
Speed: 100 Mbps	6GK6015-0AL20-0PG1 (Conformal Coated)
Interface: TX	
Port Type: M12 (4-Pin, A-Coded, Controlled Bypass)	
Distance: 100 m (328 ft)	

**RUGGEDCOM RX1500PN LM 6TX01**

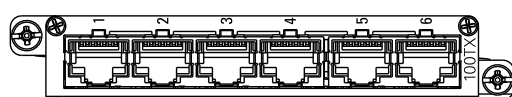

Specifications	Article Numbers
Ports: 6	6GK6015-0AL20-0NB0 (Standard)
Speed: 100 Mbps	6GK6015-0AL20-0NB1 (Conformal Coated)
Interface: TX	
Port Type: RJ45	
Distance: 100 m (328 ft)	

**Fiber Optic Ethernet Modules**

**RUGGEDCOM RX1500PN LM 4FX11**

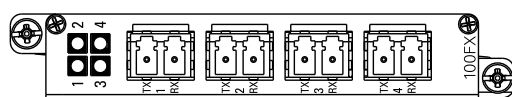

Specifications	Article Numbers
Mode: MM	6GK6015-0AL20-0BC0 (Standard)
Speed: 100 Mbps	6GK6015-0AL20-0BC1 (Conformal Coated)
Interface: FX	
Wavelength: 1300 nm	
Ports: 4	
Port Type: LC	
Distance: 2 km (1.2 mi)	

**RUGGEDCOM RX1500PN LM FL01**

Specifications	Article Numbers
----------------	-----------------

4.1 Available Modules

	<p>Mode: MM                      Speed: 10/100 Mbps                      Interface: FL/SX                      Wavelength: 820 nm                      Ports: 3                      Port Type: ST                      Distance: 2 km (1.2 mi)</p>	<p>6GK6015-0AL20-0BD0 (Standard)                      6GK6015-0AL20-0BD1 (Conformal Coated)</p>	
<p><b>RUGGEDCOM RX1500PN LM FG03</b></p>	<p><b>Specifications</b>                      Mode: SM                      Speed: 1000 Mbps                      Interface: LX                      Wavelength: 820 nm                      Ports: 4                      Port Type: LC                      Distance: 10 km (6.2 mi)</p>	<p><b>Article Numbers</b>                      6GK6015-0AL20-OECO (Standard)                      6GK6015-0AL20-OEC1 (Conformal Coated)</p>	
	<p><b>RUGGEDCOM RX1500PN LM FG50</b></p>	<p><b>Specifications</b>                      SFP Sockets: 2                      Speed: 1000 Mbps</p>	<p><b>Article Numbers</b>                      6GK6015-0AL20-OJB0 (Standard)                      6GK6015-0AL20-OJB1 (Conformal Coated)</p>
	<p><b>RUGGEDCOM RX1500PN LM FX50</b></p>	<p><b>Specifications</b>                      SFP Sockets: 4                      Speed: 100 Mbps</p>	<p><b>Article Numbers</b>                      6GK6015-0AL20-OJC0 (Standard)                      6GK6015-0AL20-OJC1 (Conformal Coated)</p>
	<p><b>RUGGEDCOM RX1500PN LM 6FX50</b></p>	<p><b>Specifications</b>                      SFP Sockets: 6                      Speed: 100 Mbps</p>	<p><b>Article Numbers</b>                      6GK6015-0AL20-OJD0 (Standard)                      6GK6015-0AL20-OJD1 (Conformal Coated)</p>

WAN Modules

	<p><b>Specifications</b>                      Standard: RS232/RS422/RS485                      Ports: 6                      Port Type: RJ45</p>	<p><b>Article Numbers</b>                      6GK6015-0AL20-OKB0 (Standard)                      6GK6015-0AL20-OKB1 (Conformal Coated)</p>	
<p><b>RUGGEDCOM RX1500PN LM TC1</b></p>	<p><b>Specifications</b>                      Interface: T1/E1                      Ports: 1                      Port Type: RJ48C</p>	<p><b>Article Numbers</b>                      6GK6015-0AL20-OMB0 (Standard)                      6GK6015-0AL20-OMB1 (Conformal Coated)</p>	
	<p><b>RUGGEDCOM RX1500PN LM TC2</b></p>	<p><b>Specifications</b>                      Interface: T1/E1</p>	<p><b>Article Numbers</b></p>

4.1 Available Modules

	<p>Ports: 2 Port Type: RJ48C</p>	<p>6GK6015-0AL20-0MC0 (Standard) 6GK6015-0AL20-0MC1 (Conformal Coated)</p>
<p><b>RUGGEDCOM RX1500PN LM TC4</b></p>	<p><b>Specifications</b></p>	<p><b>Article Numbers</b></p>
	<p>Interface: T1/E1 Ports: 4 Port Type: RJ48C</p>	<p>6GK6015-0AL20-0MD0 (Standard) 6GK6015-0AL20-0MD1 (Conformal Coated)</p>
<p><b>RUGGEDCOM RX1500PN LM E02</b></p>	<p><b>Specifications</b></p>	<p><b>Article Numbers</b></p>
	<p>Interface: E1 Ports: 2 Port Type: BNC (75 Ω)</p>	<p>6GK6015-0AL20-0HC0 (Standard) 6GK6015-0AL20-0HC1 (Conformal Coated)</p>
<p><b>RUGGEDCOM RX1500PN LM D02</b></p>	<p><b>Specifications</b></p>	<p><b>Article Numbers</b></p>
	<p>Speed: 56 kbps (Master/Slave) or 64 kbps (Slave) Ports: 1 Port Type: RJ48S</p>	<p>6GK6015-0AL20-0LB0 (Standard) 6GK6015-0AL20-0LB1 (Conformal Coated)</p>

Cellular Modem Modules

	<p><b>Specifications</b></p> <p>Services: GSM/EDGE/HSPA+ Region: North America (AT&amp;T) Port Type: 50 Ω SMA Antennas: 1 x GSM/EDGE/HSPA+, 1 x Receive Diversity (Secondary) SIM: Dual Mini-SIM (2FF)</p>	<p><b>Article Numbers</b></p> <p>6GK6015-0AL20-0WB0 (Standard) 6GK6015-0AL20-0WB1 (Conformal Coated)</p>
<p><b>RUGGEDCOM RX1500PN LM W12</b></p>	<p><b>Specifications</b></p>	<p><b>Article Numbers</b></p>
	<p>Services: GSM/EDGE/HSPA+ Region: North America (AT&amp;T), European Union, Australia Port Type: 50 Ω SMA Antennas: 2 x GSM/EDGE/HSPA+, 2 x Receive Diversity (Secondary) SIM: Dual Mini-SIM (2FF)</p>	<p>6GK6015-0AL20-0WC0 (Standard) 6GK6015-0AL20-0WC1 (Conformal Coated)</p>
<p><b>RUGGEDCOM RX1500PN LM W21</b></p>	<p><b>Specifications</b></p>	<p><b>Article Numbers</b></p>

4.1 Available Modules

	<p>Services: EVDO Rev A                      Region: North America (Verizon)                      Port Type: 50 Ω SMA                      Antennas: 1 x EVDO Rev A, 1 x Receive Diversity (Secondary)                      SIM: Dual Mini-SIM (2FF)</p>	<p>6GK6015-0AL20-0WDO (Standard)                      6GK6015-0AL20-0WD1 (Conformal Coated)</p>
<p><b>RUGGEDCOM RX1500PN LM W22</b></p>	<p><b>Specifications</b></p>	<p><b>Article Numbers</b></p>
	<p>Services: EVDO Rev A                      Region: North America (Verizon)                      Port Type: 50 Ω SMA                      Antennas: 2 x EVDO Rev A, 2 x Receive Diversity (Secondary)                      SIM: Dual Mini-SIM (2FF)</p>	<p>6GK6015-0AL20-0WE0 (Standard)                      6GK6015-0AL20-0WE1 (Conformal Coated)</p>
<p><b>RUGGEDCOM RX1500PN LM W32</b></p>	<p><b>Specifications</b></p>	<p><b>Article Numbers</b></p>
	<p>Services: EVDO Rev A                      Region: North America (Verizon)                      Port Type: 50 Ω SMA                      Antennas: 1 x GSM/EDGE/HSPA+, 1 x EVDO Rev A, 2 x Receive Diversity (Secondary)                      SIM: Dual Mini-SIM (2FF)</p>	<p>6GK6015-0AL20-0WF0 (Standard)                      6GK6015-0AL20-0WF1 (Conformal Coated)</p>
<p><b>RUGGEDCOM RX1500PN LM W41</b></p>	<p><b>Specifications</b></p>	<p><b>Article Numbers</b></p>
	<p>Services: 4G LTE/HSPA+/HSDPA/HSUPA/DC-HSPA+/UMTS/WCDAM/EDGE/GPRS/GSM/GNSS                      Region: European Union                      Port Type: 50 Ω SMA                      Antennas: 1 x LTE Main, 1 x LTE MIMO, 1 x GPS                      SIM: Dual Mini-SIM (2FF)</p>	<p>6GK6015-0AL20-0WG0 (Standard)                      6GK6015-0AL20-0WG1 (Conformal Coated)</p>
<p><b>RUGGEDCOM RX1500PN LM W51</b></p>	<p><b>Specifications</b></p>	<p><b>Article Numbers</b></p>
	<p>Services: 4G LTE/HSPA+/HSDPA/HSUPA/DC-HSPA+/UMTS/WCDAM/EDGE/GPRS/GSM/CDMA/EV-DO/GNSS</p>	<p>6GK6015-0AL20-0WH0 (Standard)                      6GK6015-0AL20-0WH1 (Conformal Coated)</p>

Region: North America (AT&T, Rogers, Bell, Telus)  
 Port Type: 50 Ω SMA  
 Antennas: 1 x LTE Main, 1 x LTE MIMO, 1 x GPS  
 SIM: Dual Mini-SIM (2FF)

**RUGGEDCOM RX1500PN LM W61**

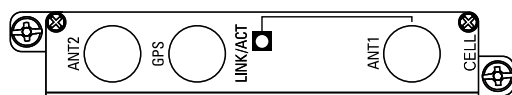

Specifications	Article Numbers
Services: 4G LTE/HSPA+/CDMA/EVDO/GPS/GNSS	6GK6015-0AL20-0WJ0 (Standard)
Region: North America (Verizon, Sprint)	6GK6015-0AL20-0WJ1 (Conformal Coated)
Port Type: 50 Ω SMA	
Antennas: 1 x LTE Main, 1 x LTE MIMO, 1 x GPS	
SIM: Dual Mini-SIM (2FF)	

**RUGGEDCOM RX1500PN LM W81**

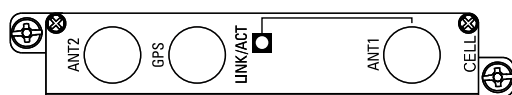

Specifications	Article Numbers
Services: 4G LTE/HSPA+/EDGE/GPRS/GSM/UMTS/GNSS	6GK60150AL200WK0 (Standard)
Region: Asia-Pacific	6GK60150AL200WK1 (Conformal Coated)
Port Type: 50 Ω SMA	
Antennas: 1 x LTE Main, 1 x LTE MIMO, 1 x GPS	
SIM: Dual Mini-SIM (2FF)	

**RUGGEDCOM APE Modules**

**RUGGEDCOM RX1500PN LM APE1402**

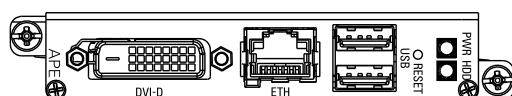

Specifications	Article Numbers
Operating System: Debian Linux®	6GK6015-0AL20-0GB0 (Standard)
Processor: Intel Atom E660 1.3 GHz, 512 KB L2 Cache	6GK6015-0AL20-0GB1 (Conformal Coated)
RAM: 2 GB DDR2, 800 MHz, 32-bit	
Disk: 8 GB SATA, Solid State	
Networking: Realtek RTL8111, RJ45 Gigabit Ethernet Interface	
USB: 2 x USB 2.0 <sup>a</sup>	
Video: Intel 4108 Graphics Processor, DVI-D	

**RUGGEDCOM RX1500PN LM APE1402W7**

Specifications	Article Numbers
----------------	-----------------

4.1 Available Modules

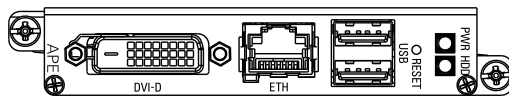

Operating System: Windows® Embedded Standard 7

Processor: Intel Atom E660 1.3 GHz, 512 KB L2 Cache

RAM: 2 GB DDR2, 800 MHz, 32-bit

Disk: 8 GB SATA, Solid State

Networking: Realtek RTL8111, RJ45 Gigabit Ethernet Interface

USB: 2 x USB 2.0<sup>a</sup>

Video: Intel 4108 Graphics Processor, DVI-D

6GK6015-0AL20-0GC0 (Standard)

6GK6015-0AL20-0GC1 (Conformal Coated)

**RUGGEDCOM RX1500PN LM APE1404**

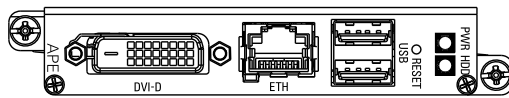

**Specifications**

Operating System: Debian Linux®

Processor: Intel Atom E660T 1.3 GHz, 512 KB L2 Cache

RAM: 2 GB DDR2, 800 MHz, 32-bit

Disk: 16 GB SATA, Solid State

Networking: Realtek RTL8111, RJ45 Gigabit Ethernet Interface

USB: 2 x USB 2.0<sup>a</sup>

Video: Intel 4108 Graphics Processor, DVI-D

**Article Numbers**

6GK6015-0AL20-0GDO (Standard)

6GK6015-0AL20-0GD1 (Conformal Coated)

**RUGGEDCOM RX1500PN LM APE1404 ADM**

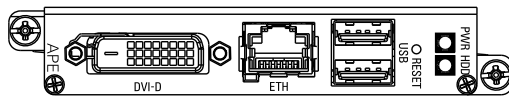

**Specifications**

Operating System: Debian Linux® and CROSSBOW ADM

Processor: Intel Atom E660T 1.3 GHz, 512 KB L2 Cache

RAM: 2 GB DDR2, 800 MHz, 32-bit

Disk: 16 GB SATA, Solid State

Networking: Realtek RTL8111, RJ45 Gigabit Ethernet Interface

USB: 2 x USB 2.0<sup>a</sup>

**Article Numbers**

6GK6015-0AL20-0GG0 (Standard)

6GK6015-0AL20-0GG1 (Conformal Coated)

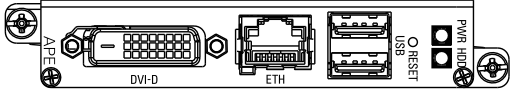
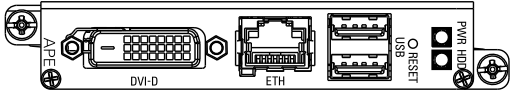
	Video: Intel 4108 Graphics Processor, DVI-D	
<b>RUGGEDCOM RX1500PN LM APE1404W7</b>	<b>Specifications</b>	<b>Article Numbers</b>
	Operating System: Windows® Embedded Standard 7	6GK6015-0AL20-0GE0 (Standard)
	Processor: Intel Atom E660T 1.3 GHz, 512 KB L2 Cache	6GK6015-0AL20-0GE1 (Conformal Coated)
	RAM: 2 GB DDR2, 800 MHz, 32-bit	
	Disk: 16 GB SATA, Solid State	
	Networking: Realtek RTL8111, RJ45 Gigabit Ethernet Interface	
	USB: 2 x USB 2.0 <sup>a</sup>	
	Video: Intel 4108 Graphics Processor, DVI-D	
<b>RUGGEDCOM RX1500PN LM APE1404CKP</b>	<b>Specifications</b>	<b>Article Numbers</b>
	Operating System: Check Point GAiA™ OS	6GK6015-0AL20-0GF0 (Standard)
	Processor: Intel Atom E660T 1.3 GHz, 512 KB L2 Cache	6GK6015-0AL20-0GF1 (Conformal Coated)
	RAM: 2 GB DDR2, 800 MHz, 32-bit	
	Disk: 16 GB SATA, Solid State	
	Networking: Realtek RTL8111, RJ45 Gigabit Ethernet Interface	
	USB: 2 x USB 2.0 <sup>a</sup>	
	Video: Intel 4108 Graphics Processor, DVI-D	

<sup>a</sup> Maximum combined USB device power consumption is 500 mA at 5 V.

### Blank Modules

<b>RUGGEDCOM RX1500PN PS XXP</b>	<b>Specifications</b>	<b>Article Numbers</b>
	—	6GK6015-0AL10-0AA0 (Standard)
		6GK6015-0AL10-0AA1 (Conformal Coated)

4.2 Installing/Removing Line Modules

RUGGEDCOM RX1500PN LM Blank	Specifications	Article Numbers
	—	6GK6015-0AL20-0AA0 (Standard) 6GK6015-0AL20-0AA1 (Conformal Coated)

## 4.2 Installing/Removing Line Modules

Upon installing a new line module in the device, all features associated with the module are available in RUGGEDCOM RX1512. For more information, refer to the *RUGGEDCOM ROX User Guide* for the RUGGEDCOM RX1512.

Once a line module is removed, all the features associated with the module are hidden or disabled in RUGGEDCOM RX1512.

 <b>CAUTION</b>
<b>Electrical hazard – risk of power failure</b>
Do not install more than one APE module. Installing more than two of this type of module can lead to power fluctuations and irregular shut downs.

<b>NOTICE</b>
Only one WAN line module is supported per chassis.

 <b>CAUTION</b>
<b>Contamination hazard – risk of equipment damage</b>
Prevent the ingress of water, dirt and other debris that may lead to premature equipment failure. Always make sure slots are not left empty and open ports are protected with plugs or covers.

### Removing a Module

To remove a line module, do the following:

1. [Optional] If the device is installed in a rack, remove it from the rack.
2. Loosen the screws that secure the module.

3. Pull the module from the chassis to disconnect it.

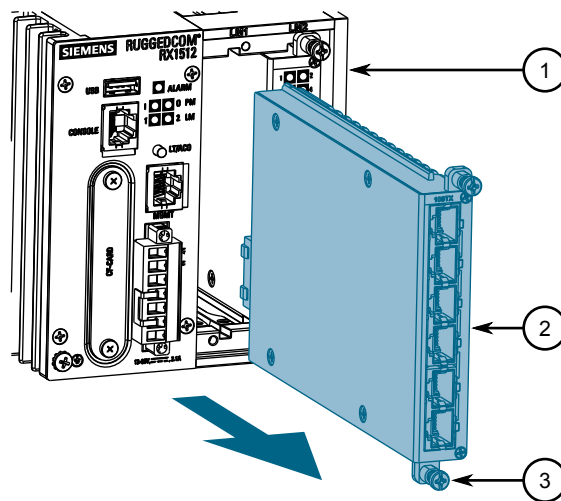

- ① Module
- ② Chassis
- ③ Screw

Figure 4.2 Removing a Module

4. Install a new module or a blank module (to prevent the ingress of dust and dirt).
5. [Optional] If necessary, install the device in the rack.

### Installing a Module

To install a line module, do the following:

1. [Optional] If the device is installed in a rack, remove it from the rack.
2. Remove the current module from the slot.

3. Insert the new module into the slot.

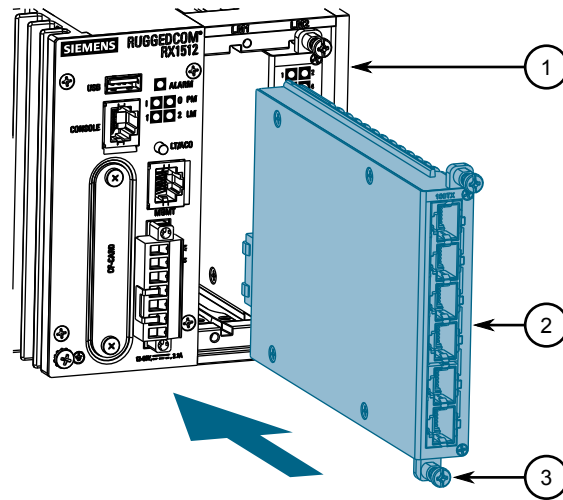

- ① Module
- ② Chassis
- ③ Screw

Figure 4.3 Installing a Module

4. Tighten the screws to secure the module.
5. [Optional] If necessary, install the device in the rack.

## Technical Specifications

This section provides important technical specifications related to the device.

### 5.1 Power Supply Specifications

#### Note

When determining cable lengths, make sure the minimum input voltage for the power supply is provided at the power source.

Power Supply Type	Input Range		Internal Fuse Rating	Maximum Power Consumption <sup>a</sup>
	Min	Max		
Internal	11 VDC	72 VDC	6.3 A	26.4 W

<sup>a</sup> Power consumption varies based on the device configuration.

### 5.2 Failsafe Relay Specifications

Maximum Switching Voltage	Rated Switching Current	Isolation
30 VDC	2 A, 60 W	1500 V <sub>rms</sub> for 1 minute between coil and contacts
125 VDC	0.24 A, 30 W	
125 VAC	0.5 A, 62.5 W	
220 VDC	0.24 A, 60 W	
250 VAC	0.25 A, 62.5 W	

### 5.3 Operating Environment

The RUGGEDCOM RX1512 is rated to operate under the following environmental conditions.

#### NOTICE

Temperature limits for select line modules may differ from that which can be withstood by the RUGGEDCOM RX1512. Make sure the selected modules are rated for the expected environmental conditions before deployment. For more information, refer to the *RUGGEDCOM RX1512 Series Modules Catalog*.

Ambient Operating Temperature <sup>a b c</sup>	-40 to 85 °C (-40 to 185 °F)
Ambient Storage Temperature	-40 to 85 °C (-40 to 185 °F)

5.4 Mechanical Specifications

<b>Ambient Relative Humidity<sup>d</sup></b>	5% to 95%
<b>Maximum Altitude</b>	2000 m (6562 ft)

- <sup>a</sup> Maximum ambient operating temperature is 70 °C (158 °F) when the device is installed along with Underwriter Laboratories (UL) listed devices.
- <sup>b</sup> Measured from a 30 cm (12 in) radius surrounding the center of the enclosure.
- <sup>c</sup> Operating temperature may vary based on the limitations of installed SFPs. Refer to the *RUGGEDCOM SFP Transceivers Catalog* for SFP temperature ratings.
- <sup>d</sup> Non-condensing.

5.4 Mechanical Specifications

<b>Weight</b>	Approximately 2.3 kg (5 lb)
<b>Ingress Protection</b>	IP30
<b>Enclosure</b>	Aluminum

5.5 Dimension Drawings

**Note**  
All dimensions are in millimeters, unless otherwise stated.

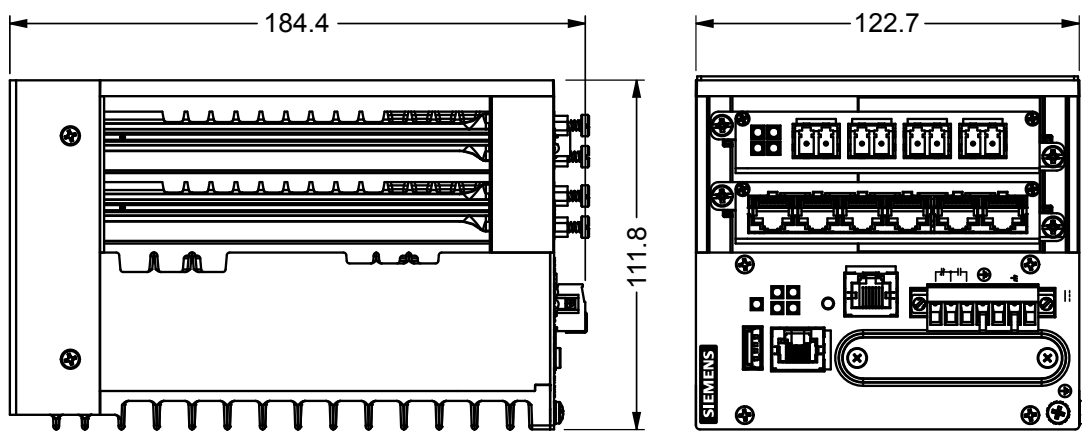

Figure 5.1 Overall Dimensions

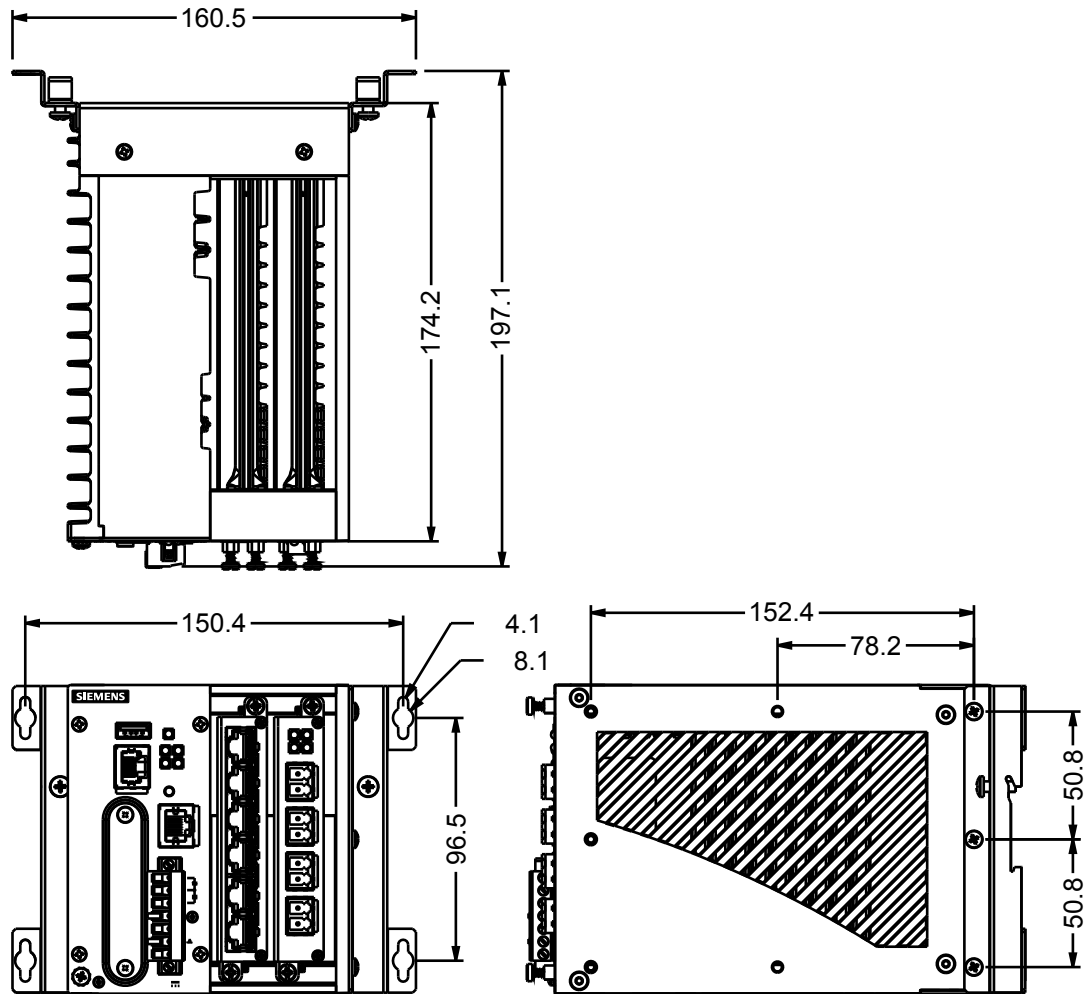

Figure 5.2 Panel and Din Rail Mount Dimensions

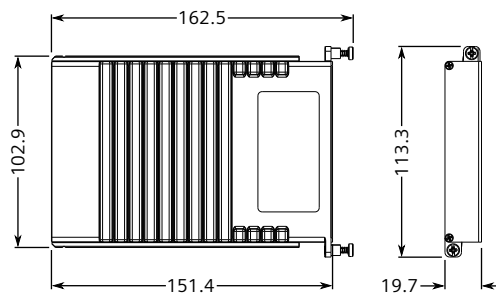

Figure 5.3 Line Module Dimensions

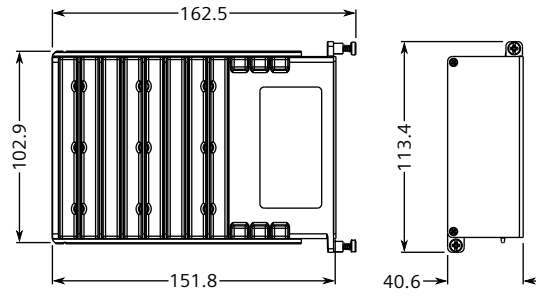

Figure 5.4 Power Module Dimensions

## Certification

The RUGGEDCOM RX1512 device has been thoroughly tested to guarantee its conformance with recognized standards and has received approval from recognized regulatory agencies.

---

**Note**

Certifications related to individual modules are detailed in the *RUGGEDCOM Modules Catalog* for the device available online.

---

### 6.1 Approvals

This section details the standards to which the RUGGEDCOM RX1512 complies.

#### 6.1.1 TÜV SÜD

This device is certified by TÜV SÜD to meet the requirements of the following standards:

- **CAN/CSA-C22.2 NO. 60950-1-07 (R2012)**  
Information Technology Equipment – Safety – Part 1: General Requirements (Bi-National standard, with UL 60950-1)
- **UL 60950-1**  
Information Technology Equipment – Safety – Part 1: General Requirements)

#### 6.1.2 European Union (EU)

This device is declared by Siemens AG to comply with essential requirements and other relevant provisions of the following EU directives:

- **Directive 2014/30/EU**  
Directive 2014/30/EU of the European Parliament and of the Council of 26 February 2014 on the harmonisation of the laws of the Member States relating to electromagnetic compatibility (recast) Text with EEA relevance
- **Directive 2014/35/EU**  
Directive 2014/35/EU of the European Parliament and of the Council of 26 February 2014 on the harmonisation of the laws of the Member States relating to the

making available on the market of electrical equipment designed for use within certain voltage limits Text with EEA relevance

- **Directive 2011/65/EU**

Directive 2011/65/EU of the European Parliament and of the Council of 8 June 2011 on the restriction of the use of certain hazardous substances in electrical and electronic equipment Text with EEA relevance

- **Directive 1999/5/EC**

Directive 1999/5/EC of the European Parliament and of the Council of 9 March 1999 on radio equipment and telecommunications terminal equipment and the mutual recognition of their conformity

- **EN 60950-1**

Information Technology Equipment – Safety – Part 1: General Requirements

- **EN 61000-3-2**

Electromagnetic compatibility (EMC) – Part 3-2: Limits – Limits for harmonic current emissions (equipment input current  $\leq 16$  A per phase)

- **EN 61000-3-3**

Electromagnetic compatibility (EMC) – Part 3-3: Limits – Limitation of voltage changes, voltage fluctuations and flicker in public low-voltage supply systems, for equipment with rated current  $\leq 16$  A per phase and not subject to conditional connection

- **EN 61000-6-2**

Electromagnetic Compatibility (EMC) – Part 6-2: Generic Standards – Immunity for Industrial Environments

- **EN 60825-1**

Safety of Laser Products – Equipment Classification and Requirements

- **EN 50581**

Technical Documentation for the Assessment of Electrical and Electronic Products with Respect to the Restriction of Hazardous Substances

- **EN 55022**

Information Technology Equipment – Radio Disturbance Characteristics – Limits and Methods of Measurement

The device is marked with a CE marking and notified body number, and can be used throughout the European community.

**CE 0680**

A copy of the CE Declaration of Conformity is available from Siemens AG. For contact information, refer to "[Contacting Siemens \(Page vii\)](#)".

### 6.1.3 FCC

This device has been tested and found to comply with the limits for a Class A digital device, pursuant to Part 15 of the FCC Rules. These limits are designed to provide reasonable protection against harmful interference when the equipment is operated in a commercial environment.

This device generates, uses and can radiate radio frequency energy and, if not installed and used in accordance with the instruction manual, may cause harmful interference to radio communications. Operation of this equipment in a residential area is likely to cause harmful interference in which case users will be required to correct the interference at their own expense.

<b>NOTICE</b>
Changes or modifications not expressly approved by the party responsible for compliance could void the user's authority to operate this device.

### 6.1.4 FDA/CDRH

This device meets the requirements of the following U.S. Food and Drug Administration (FDA) standard:

- Title 21 Code of Federal Regulations (CFR) – Chapter I – Sub-chapter J – Radiological Health

### 6.1.5 ISED

This device is declared by Siemens AG to meet the requirements of the following ISED (Innovation Science and Economic Development Canada) standard:

- CAN ICES-3 (A)/NMB-3 (A)

### 6.1.6 RoHS

This device is declared by Siemens AG to meet the requirements of the following RoHS (Restriction of Hazardous Substances) directives for the restricted use of certain hazardous substances in electrical and electronic equipment:

- **China RoHS 2**

Administrative Measure on the Control of Pollution Caused by Electronic Information Products

A copy of the Material Declaration is available online at <https://support.industry.siemens.com/cs/ww/en/view/109738831>.

### 6.1.7 Other Approvals

This device meets the requirements of the following additional standards:

- **IEEE 1613**  
IEEE Standard Environmental and Testing Requirements for Communications Networking Devices in Electric Power Substations
- **IEC 61000-6-2**  
Electromagnetic Compatibility (EMC) – Part 6-2: Generic Standards – Immunity for Industrial Environments
- **IEC 61850-3**  
Communication Networks and Systems in Substations – Part 3: General Requirements

## 6.2 EMC and Environmental Type Tests

The RUGGEDCOM RX1512 has passed the following Electromagnetic Compatibility (EMC) and environmental tests.

### EMC Type Test for IEC 61850-3

Test	Description		Test Levels	Severity Levels	
IEC 61000-4-2	ESD	Enclosure Contact	± 8 kV	4	
		Enclosure Air	± 15 kV		
IEC 61000-4-3	Radiated RFI	Enclosure Ports	20 V/m	Note <sup>a</sup>	
IEC 61000-4-4		Burst (Fast Transient)	Signal ports		± 4 kV @ 2.5 kHz
			DC Power Ports		± 4 kV
IEC 61000-4-5	Surge	Earth ground ports			
		Signal ports	± 2 kV Line-to-Ground ± 2 kV Line-to-Line	4	
IEC 61000-4-6	Induced (Conducted) RFI	DC Power Ports	± 2 kV Line-to-Ground ± 1 kV Line-to-Line	3	
		Signal ports	10 V	3	
IEC 61000-4-8	Magnetic Field	Enclosure Ports	100 A/m, continuous 1000 A/m for 1 s	Note <sup>a</sup>	
			1000 A/m for 1 s	5	
IEC 61000-4-12	Damped Oscillatory	Signal ports	2.5 kV common, 1 kV differential mode @1 MHz	3	
		DC Power Ports			
IEC 61000-4-16	Mains Frequency Voltage	Signal ports	30 V Continuous 300 V for 1 s	4	
		DC Power Ports			

6.2 EMC and Environmental Type Tests

Test	Description		Test Levels	Severity Levels
IEC 61000-4-17	Ripple on DC Power Supply	DC Power Ports	10%	3
IEC 61000-4-29	Voltage Dips and Interrupts	DC Power Ports	30% for 0.1 s 60% for 0.1 s 100% for 0.05 s	
IEC 60255-5	Dielectric Strength	Signal ports	2 kV (Failsafe Relay output)	
		DC Power Ports	2 kV	
	HV Impulse	Signal ports	5 kV (Failsafe Relay output)	
		DC Power Ports	5 kV	

<sup>a</sup> Siemens-specified severity levels

EMC Immunity Type Tests for IEEE 1613

**Note**

The RUGGEDCOM RX1512 meets Class 2 requirements for an all-fiber configuration and Class 1 requirements for copper ports. Class 1 allows for temporary communication loss, while Class 2 requires error-free and interrupted communications.

Description		Test Levels
HV Impulse	Signal ports	5 kV (Failsafe Relay Output)
	DC Power Ports	5 kV
Dielectric Strength	Signal ports	2 kV
	DC Power Ports	2 kV
Fast Transient	Signal ports	± 4 kV @ 2.5 kHz
	DC Power Ports	± 4 kV
	Earth ground ports	
Oscillatory	Signal ports	2.5 kV common mode @1MHz
	DC Power Ports	2.5 kV common 1 kV differential mode @ 1 MHz
Radiated RFI	Enclosure ports	35 V/m
ESD	Enclosure Contact	± 8 kV
	Enclosure Air	± 15 kV

Environmental Type Tests

Test	Description		Test Levels	Severity Levels
IEC 60068-2-1	Cold Temperature	Test Ad	-40 °C (-40 °F), 16 Hours	
IEC 60068-2-2	Dry Heat	Test Bd	85 °C (185 °F), 16 Hours	
IEC 60068-2-30	Humidity (Damp Heat, Cyclic)	Test Db	95% (non-condensing), 55 °C (131 °F), 6 cycles	
IEC 60255-21-1	Vibration		2 g @ 10-150 Hz	Class 2

6.2 EMC and Environmental Type Tests

---

Test	Description	Test Levels	Severity Levels
IEC 60255-21-2	Shock	30 g @ 11 ms	Class 2
	Bump	10 g @ 16 ms	Class 1
IEC 60255-21-3	Seismic	Method A	Level 2

## Further Information

Siemens  
<https://www.siemens.com>

Industry Online Support (service and support)  
<https://support.industry.siemens.com>

Industry Mall  
<https://mall.industry.siemens.com>

Siemens AG  
Digital Industry  
Process Automation  
Postfach 48 48  
90026 NÜRNBERG  
GERMANY