

SIEMENS

Position signaling switch

Positionsmeldeschalter

Contact de signalisation de position

Interruptor de señalización de posición

Contatti di segnalazione posizione

Chave sinalizadora de posição

Pozisyon bildirim şalteri

Выключатель положения с сигнальными контактами

Przełącznik zgłaszania pozycji

位置信息开关

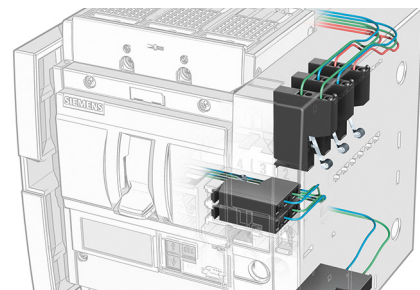

3VA9977 - 0KB00

Operating Instructions Betriebsanleitung

Instruções de Serviço İşletme kılavuzu

Notice d'utilisation

Руководство по эксплуатации

Instructivo

Instrukcja obsługi

Istruzioni operative





使用説明

		EN DANGER Hazardous voltage. Will cause death or serious injury. Turn off and lock out all power supplying this device before working on this device. Replace all covers before power supplying this device is turned on.
		NOTICE Installation and maintenance must be carried out by qualified personnel.
DE GEFAHR Gefährliche Spannung. Lebensgefahr oder schwere Verletzungsgefahr. Bevor Arbeiten am Gerät durchgeführt werden, müssen alle Stromquellen ausgeschaltet und mit einer Einschaltssicherung versehen werden. Vor dem Wiedereinschalten der Stromquellen müssen alle Abdeckungen wieder angebracht werden.	FR DANGER Tension électrique dangereuse. Danger de mort ou risque de blessures graves. Avant d'intervenir sur l'appareil, couper toutes les sources de tension et les consigner contre la refermeture. Remettre en place tous les couvercles avant de remettre l'appareil sous tension.	
HINWEIS Installations- und Wartungsarbeiten sind von qualifiziertem Personal durchzuführen.	NOTIFICATION L'installation et la maintenance doivent être effectuées uniquement par des personnes qualifiées.	
ES PELIGRO Tensión peligrosa. Puede causar la muerte o lesiones graves. Antes de trabajar en este dispositivo, desconecte y bloquee todas las fuentes que lo alimentan eléctricamente. Recoloque todas las cubiertas antes de volver a conectar la alimentación eléctrica para este dispositivo.	IT PERICOLO Tensione pericolosa. Può causare la morte o lesioni gravi. Prima di lavorare su questa apparecchiatura, disinserire tutte le fonti di alimentazione elettrica dell'apparecchiatura ed assicurarle contro la reinserzione. Riapplicare tutte le coperture prima di reinserire l'alimentazione di questa apparecchiatura.	
NOTA La instalación y el mantenimiento deben corre a cargo de personal cualificado.	NOTA L'installazione e la manutenzione devono essere eseguite da personale qualificato.	
PT PERIGO Tensão perigosa. Perigo de morte ou ferimentos graves. Desligue e bloqueie todas as fontes de alimentação antes de executar quaisquer trabalhos no aparelho. Volte a colocar todas as coberturas antes de voltar a ligar as fontes de alimentação.	TR TEHLİKE Tehlikeli gerilim. Ölüm tehlikesi veya ağır yaralanma tehlikesi mevcuttur. Cihazda çalışmalar yapılmadan önce, tüm güç kaynakları kapatılmalı ve bir açma emniyetiyle donatılmalıdır. Güç kaynakları tekrar açılmadan önce tüm kapaklar yerlerine takılmalıdır.	
ATENÇÃO A instalação e manutenção têm de ser efetuadas por pessoal qualificado.	NOT Montaj ve bakım işlemleri kalifiye personel tarafından yapılmalıdır.	
РУ ОПАСНО Опасное напряжение. Опасность для жизни или телесных повреждений. До начала работы выключите и заблокируйте все источники питания этого устройства. Перед включением питания снова установите все крышки.	PL ZAGROŻENIE Niebezpieczne napięcie. Niebezpieczeństwo poważnych obrażeń lub utraty życia. Wyłączyć i zablokować wszystkie źródła zasilania urządzenia przed rozpoczęciem pracy na urządzeniu. Założyć wszystkie osłony przed podłączeniem urządzenia do źródła zasilania.	
ПРИМЕЧАНИЕ Установка и техническое обслуживание должны производиться квалифицированным персоналом.	UWAGA Instalacja i konserwacja muszą być wykonywane przez wykwalifikowany personel.	

Technical Support:

Internet: <http://www.siemens.com/lowvoltage/technical-support>

<p>中  危险</p> <p>危险电压。可能导致生命危险或重伤危险。操作此设备前必须确保切断其电源并采取防接通保护措施。在设备接通电源前，更换所有盖板。</p>	<p>HR  OPASNOST</p> <p>Opasni napon. Opasnost po život ili opasnost od teških ozljeda. Prije rada na uređaju potrebno je isključiti sve izvore struje i osigurati uređaj zaštitom od uključivanja. Prije ponovnog uključivanja izvora struje potrebno je opet postaviti sve poklopce.</p>
<p> 注意</p> <p>安装和维护必须由具备专业资质的人员进行。</p>	<p> НАПОМЕНА</p> <p>Montažu i održavanje treba obavljati kvalificirano osoblje.</p>
<p>FI  VAARA</p> <p>Vaarallinen jännite. Vakava loukkaantumisvaara tai hengenvaara. Laitteen kaikki virransyöttö tulee katkaista ja sen kytkeytyminen päälle tulee estää lukolla ennen kuin laitteeseen kohdistetaan mitään toimenpiteitä. Kaikki kotelot tulee kiinnittää takaisin ennen kuin laitteen virransyöttö kytketään uudelleen päälle.</p>	<p>БГ  ОПАСНОСТ</p> <p>Опасно напряжение. Опасност за живота или опасност от тежки телесни повреди. Преди да извършвате дейности по устройството, изключете и обезопасете всички захранващи източници. Поставете всички капацити на мястото им, преди отново да включите захранването на устройството.</p>
<p> HUOMAUTUS</p> <p>Asennus- ja huoltotyöt on annettava pätevän ammattilaisen suorittaviksi.</p>	<p> ПРЕДУПРЕЖДЕНИЕ</p> <p>Инсталирането и поддръжката трябва да се извършват от квалифициран персонал.</p>
<p>EE  OHT</p> <p>Ohtlik pinge. Oht elule või raskete vigastuste oht. Enne seadme hoolustoid lülitage kõik toiteallikad välja ja võtke meetmeid nende sisselülitamise takistamiseks. Enne toiteallikate uuesti sisselülitamist tuleb kõik katted tagasi paigaldada.</p>	<p>LV  BĪSTAMI</p> <p>Bīstams spriegums. Letālu seku vai smagu traumu risks. Pirms veicat darbu ar šo ierīci pilnībā izslēdziet un nobloķējiet tās strāvas padevi. Pirms ieslēdzat ierīces strāvas padevi uzlieciet atpakaļ visus pārsegus.</p>
<p> MÄRKUS</p> <p>Paigaldus- ja hoolustoid tohib teha ainult kvalifitseeritud personal.</p>	<p> BRĪDINĀJUMS</p> <p>Uzstādīšana un tehniskā apkope jāveic kvalificētiem darbiniekiem.</p>
<p>LT  PAVOJUS</p> <p>Pavojinga įtampa. Pavojus gyvybei arba sunkausi susižalojimo pavojus. Prieš dirbdami ties šiuo prietaisu, išjunkite ir užblokuokite visus šio prietaiso maitinimo šaltinius. Prieš jungdami šio prietaiso maitinimo šaltinį, vėl uždėkite visus dangčius.</p>	<p>DA  FARE</p> <p>Farlig spænding. Livsfare eller risiko for slemme kvæstelser. Sluk for og lås strømmen, der forsyner denne enhed, før du arbejder med denne enhed. Erstat alle afdækninger, før strømmen, der tilføres denne enhed, tændes.</p>
<p> NUORODA</p> <p>Įrengimą ir techninę priežiūrą turi vykdyti kvalifikuoti darbuotojai.</p>	<p> BEMÆRK</p> <p>Installationen og vedligeholdelsen skal foretages af uddannet personale.</p>
<p>MT  PERIKLU</p> <p>Vultaġġ perikoluż. Riskju ta' mewt jew korriment serju. Qabel taħdem fuq dan l-apparat, itfi kull provvista tal-elettriku tiegħu u sakkar kontra xegħil mill-gdid aċċidentali. Erga' installa l-ghotjien kollha qabel tirritorna l-provvista tal-elettriku fl-apparat.</p>	<p>NL  GEVAAR</p> <p>Gevaarlijke spanning. Levensgevaar of gevaar voor ernstig letsel. Voordat u aan dit apparaat werkt, moet u alle actieve energiebronnen voor dit apparaat uitschakelen. Plaats alle afdekkingen terug voordat u energiebronnen voor dit apparaat inschakelt.</p>
<p> AVVIŻ</p> <p>L-installazzjoni u l-manutenzjoni għandhom jitwettqu minn personal ikkwalifikat.</p>	<p> OPMERKING</p> <p>Installatie en onderhoud moeten worden verricht door gekwalificeerd personeel.</p>
<p>EL  ΚΙΝΔΥΝΟΣ</p> <p>Επικίνδυνη τάση. Κίνδυνος για τη ζωή ή σοβαρού τραυματισμού. Απενεργοποιήστε και ασφαλίστε όλη την ενέργεια που τροφοδοτεί τη συσκευή, προτού εργαστείτε σε αυτή. Τοποθετήστε ξανά όλα τα καλύμματα, προτού ενεργοποιήσετε την τροφοδοσία της συσκευής με ενέργεια.</p>	<p>GA  CONTÚIRT</p> <p>Voltas contúirteach. Baol go bhfaighfear bás nó tromghortú. Múch gach cumhacht a sholáthraíonn an gléas seo agus glasáil amach í roimh obair a dhéanamh ar an ngléas seo. Cuir na clúdaigh ar fad ar ais roimh an gcumhacht a sholáthraíonn an gléas seo a chur ar siúl arís.</p>
<p> ΠΡΟΣΟΧΉ</p> <p>Η εγκατάσταση και συντήρηση πρέπει να διεξάγονται από εξειδικευμένο προσωπικό.</p>	<p> FÓGRA</p> <p>Ní mór don fheistiú agus don chothabháil a bheith déanta ag pearsanra cáilithe.</p>
<p>RO  PERICOL</p> <p>Tensiune periculoasă. Pericol de moarte sau de accidentări grave. Opriți și blocați alimentarea cu energie a acestui dispozitiv înainte de a lucra la acesta. Așezați la loc toate capacele înainte de a porni alimentarea cu energie a acestui dispozitiv.</p>	<p>SV  FARA</p> <p>Farlig spänning. Livsfara eller risk för allvarliga personskador. Innan arbete utförst på utrustningen ska strömförsörjningen till utrustningen stängas av. Montera alla skyddsplåtar igen innan utrustningen slås på.</p>
<p> ÎNȘTIINȚARE</p> <p>Instalarea și întreținerea trebuie să se efectueze de către personalul calificat.</p>	<p> OBS</p> <p>Installation och underhåll får endast utföras av kvalificerad personal.</p>
<p>CZ  NEBEZPEČÍ</p> <p>Nebezpečné napětí. Nebezpečí smrtelného nebo těžkého úrazu. Před zahájením prací na tomto zařízení odpojte a zajistěte veškeré přívody energie. Před opětovným připojením zařízení vraťte všechny kryty na svá místa.</p>	<p>SL  NEVARNOST</p> <p>Nevarna napetost. Nevarnost za življenje ali nevarnost hudih poškodb. Izklopite in prekinite celotno napajanje naprave, preden na njej opravljate dela. Preden napajanje znova vklopite, namestite vse pokrove.</p>
<p> POZNÁMKA</p> <p>Instalaci a údržbu musí provádět kvalifikovaní pracovníci.</p>	<p> OPOMBA</p> <p>Namestitev in vzdrževanje mora opraviti usposobljeno osebje.</p>
<p>SK  NEBEZPEČENSTVO</p> <p>Nebezpečné napätie. Nebezpečenstvo ohrozenia života alebo vzniku ťažkých zranení. Pred prácou na zariadení vypnite a zaistíte všetky napájacie prípojky tohto zariadenia. Pred zapnutím napájania tohto zariadenia najprv nasad'te späť všetky kryty.</p>	<p>HU  VESZÉLY</p> <p>Veszélyes feszültség. Életveszély vagy súlyos sérülésveszély. Mielőtt bármilyen munkavégzést kezd az eszközön, az áramellátást le kell kapcsolni, és véletlen bekapcsolás elleni védelemmel kell ellátni. Az áramellátás visszakapcsolása előtt minden burkolatot vissza kell helyezni.</p>
<p> UPOZORNENIE</p> <p>Inštaláciu a údržbu musí vykonávať kvalifikovaný personál.</p>	<p> MEGJEGYZÉS</p> <p>A telepítést és a karbantartást kizárólag szakképzett személyzet végezheti.</p>

		EN  DANGER Hazardous voltage. Will cause death or serious injury. Turn off and lock out all power supplying this device before working on this device. Replace all covers before power supplying this device is turned on.
ES  PELIGRO Tensión peligrosa. Puede causar la muerte o lesiones graves. Antes de trabajar en este dispositivo, desconecte y bloquee todas las fuentes que lo alimentan eléctricamente. Recoloque todas las cubiertas antes de volver a conectar la alimentación eléctrica para este dispositivo.	FR  DANGER Tension électrique dangereuse. Danger de mort ou risque de blessures graves. Avant d'intervenir sur l'appareil, couper toutes les sources de tension et les consigner contre la refermeture. Remettez en place tous les couvercles avant de remettre l'appareil sous tension.	



Contents / Lieferumfang / Etendue de la livraison / Alcance de suministro / 供货范围

Required tools / Notwendige Werkzeuge / Outils nécessaires / Herramientas requeridas / 必要工具

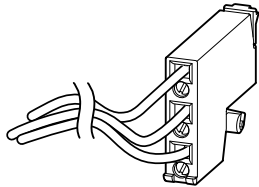

 AWG [mm²]
18 [1.0] UL 1015





cal. ISO 6789



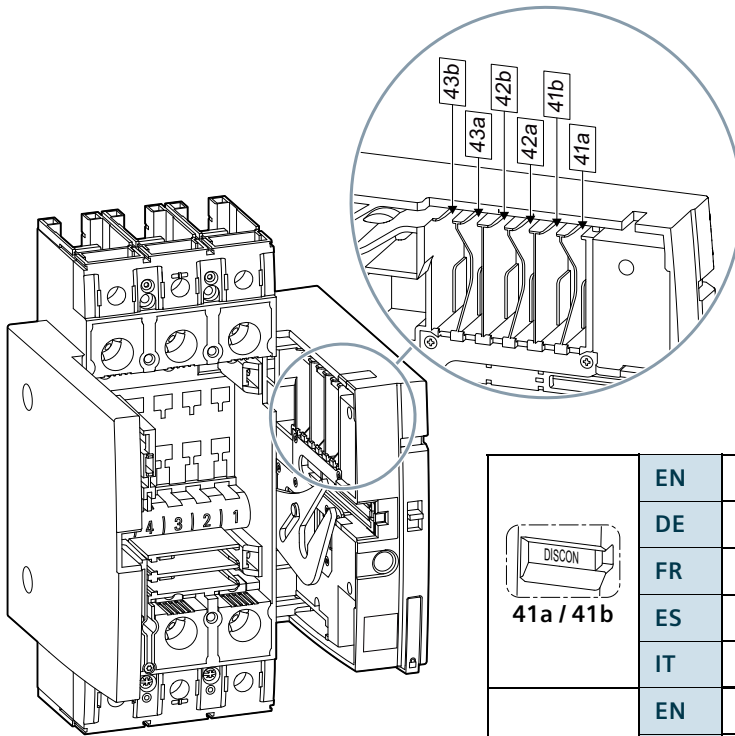

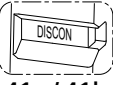
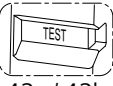
Information / Information / Informations / Información / 信息

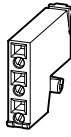

 41a / 41b	EN	Disconnected	PT	Extraída
	DE	Ausgefahren	TR	Dışarı çıktı
	FR	Débroché	PY	разъезженный
	ES	Extraído	PL	Wysunięty
	IT	Estratto	中	已驶出
 42a / 42b	EN	Test position	PT	Posição de teste
	DE	Teststellung	TR	Test konumu
	FR	Position d'essai	PY	Испытательное положение
	ES	Posición de Prueba	PL	Instalacja testowa
	IT	Posizione di test	中	试验位置
 43a / 43b	EN	Connected	PT	Inserida
	DE	Eingefahren	TR	İçeri girdi
	FR	Embroché	PY	втянутый
	ES	Insertado	PL	Schowany
	IT	Rientrato	中	已驶入

Connection / Anschluss / Raccordement / Conexión / 连接

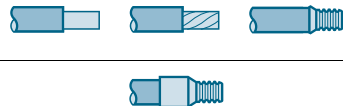

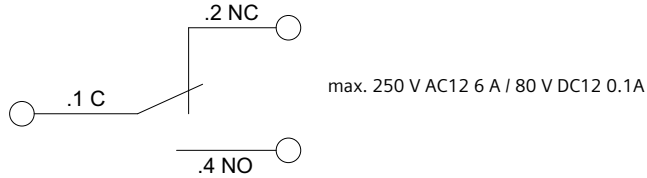





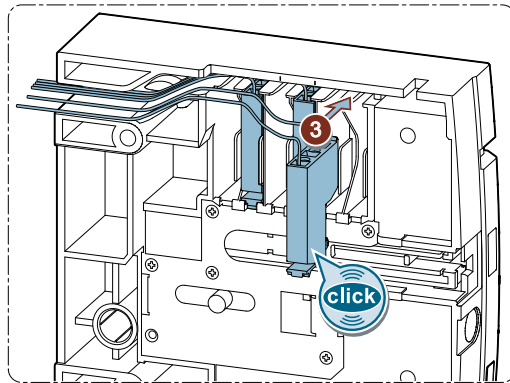

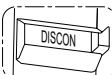
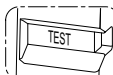

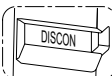

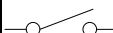
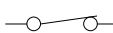

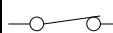
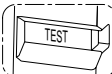
105°C	 AWG [mm²]		
	1 x (20 - 16) [1 x (0.5 - 1.5)]	4.0 +/- 0.4 [0.45 +/- 0.05]	0.4 [10]
	1 x (20 - 18) [1 x (0.5 - 1.0)]		

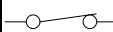
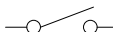
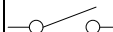
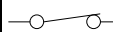
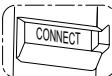



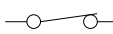
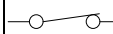
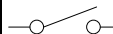
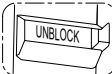

Assembly / Montage / Montage / Montaje / 安装

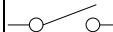
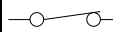
3VA9... - 0KD00

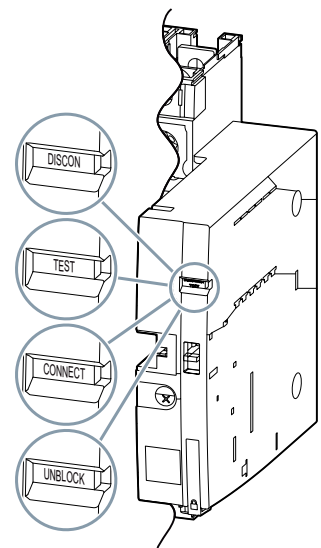

						
	41a / 41b		42a / 42b		43a / 43b	
	NO	NC	NO	NC	NO	NC
						
						
						
						



		EN  DANGER Hazardous voltage. Will cause death or serious injury. Turn off and lock out all power supplying this device before working on this device. Replace all covers before power supplying this device is turned on.
ES  PELIGRO Tensión peligrosa. Puede causar la muerte o lesiones graves. Antes de trabajar en este dispositivo, desconecte y bloquee todas las fuentes que lo alimentan eléctricamente. Recoloque todas las cubiertas antes de volver a conectar la alimentación eléctrica para este dispositivo.	FR  DANGER Tension électrique dangereuse. Danger de mort ou risque de blessures graves. Avant d'intervenir sur l'appareil, couper toutes les sources de tension et les consigner contre la refermeture. Remettez en place tous les couvercles avant de remettre l'appareil sous tension.	







Assembly / Montage / Montage / Montaje / 安装

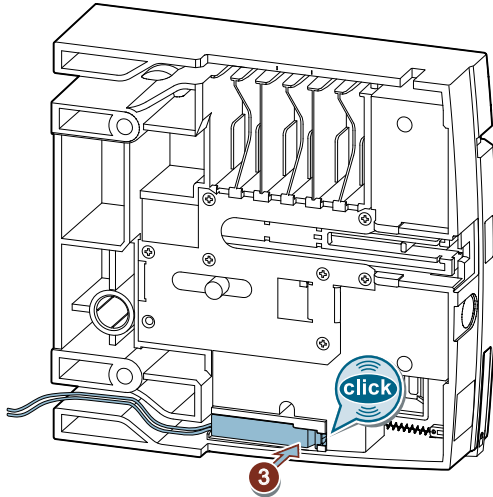

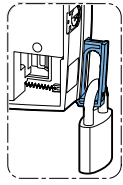

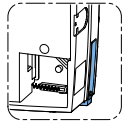
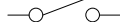

3VA9.4. - 0KD00

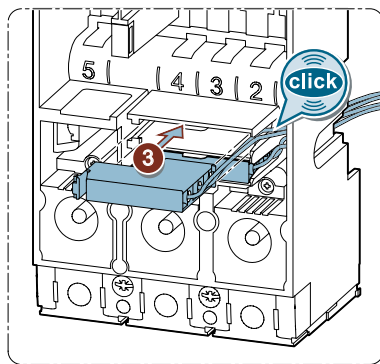

	NO	NC
		
		

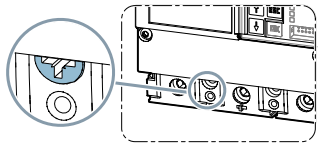
3VA9.4. - 0KP00

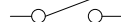
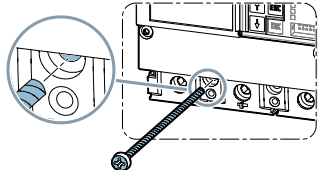

	NO	NC
		
		

EN

NOTICE

These instructions do not purport to cover all details or variations in equipment, or to provide for every possible contingency in connection with installation, operation, or maintenance. Should additional information be desired, please contact the local Siemens sales office. The contents of this instruction manual shall not become part of or modify any prior or existing agreement, commitment, or relationship. The sales contract contains the entire obligation of Siemens. The warranty contained in the contract between the parties is the sole warranty of Siemens. Any statements contained herein do not create new warranties or modify the existing warranty.

Trademarks - Unless otherwise noted, all names identified by ® are registered trademarks of Siemens AG or Siemens Industry, Inc. The remaining trademarks in this publication may be trademarks whose use by third parties for their own purposes could violate the rights of the owner.