

Power contactor, AC-3 9 A, 4 kW / 400 V 1 NO, 24 V DC, 0.7-1.25*US with integrated suppressor diode 3-pole, Size S00, screw terminal suitable for PLC outputs



Product brand name	SIRIUS
Product designation	Coupling relay
Product type designation	3RT2

General technical data	
Size of contactor	S00
Product extension	
<ul style="list-style-type: none"> function module for communication 	No
<ul style="list-style-type: none"> Auxiliary switch 	No
Power loss [W] for rated value of the current	
<ul style="list-style-type: none"> at AC in hot operating state 	2.1 W
<ul style="list-style-type: none"> at AC in hot operating state per pole 	0.7 W
Power loss [W] for rated value of the current without load current share typical	2.8 W
Surge voltage resistance	
<ul style="list-style-type: none"> of main circuit rated value 	6 kV
<ul style="list-style-type: none"> of auxiliary circuit rated value 	6 kV
maximum permissible voltage for safe isolation	
<ul style="list-style-type: none"> between coil and main contacts acc. to EN 60947-1 	400 V

Protection class IP	
• on the front	IP20
• of the terminal	IP20
Shock resistance at rectangular impulse	
• at DC	6,7g / 5 ms, 4,2g / 10 ms
Shock resistance with sine pulse	
• at DC	10,5g / 5 ms, 6,6g / 10 ms
Mechanical service life (switching cycles)	
• of contactor typical	30 000 000
Reference code acc. to DIN 40719 extended according to IEC 204-2 acc. to IEC 750	K
Reference code acc. to DIN EN 81346-2	Q

Ambient conditions

Installation altitude at height above sea level	
• maximum	2 000 m
Ambient temperature	
• during operation	-25 ... +60 °C
• during storage	-55 ... +80 °C

Main circuit

Number of poles for main current circuit	3
Number of NO contacts for main contacts	3
Operating voltage	
• at AC-3 rated value maximum	690 V
Operating current	
• at AC-1 at 400 V	
— at ambient temperature 40 °C rated value	22 A
• at AC-1	
— up to 690 V at ambient temperature 40 °C rated value	22 A
— up to 690 V at ambient temperature 60 °C rated value	20 A
• at AC-2 at 400 V rated value	9 A
• at AC-3	
— at 400 V rated value	9 A
— at 500 V rated value	7.7 A
— at 690 V rated value	6.7 A
• at AC-4 at 400 V rated value	8.5 A
• at AC-5a up to 690 V rated value	19.4 A
• at AC-5b up to 400 V rated value	7.4 A
• at AC-6a	
— up to 230 V for current peak value n=20 rated value	5.3 A

— up to 400 V for current peak value n=20 rated value	5.3 A
— up to 500 V for current peak value n=20 rated value	5.3 A
— up to 690 V for current peak value n=20 rated value	5 A
• at AC-6a	
— up to 230 V for current peak value n=30 rated value	3.5 A
— up to 400 V for current peak value n=30 rated value	3.5 A
— up to 500 V for current peak value n=30 rated value	3.6 A
— up to 690 V for current peak value n=30 rated value	3.3 A
Minimum cross-section in main circuit	
• at maximum AC-1 rated value	4 mm ²
Operating current for approx. 200000 operating cycles at AC-4	
• at 400 V rated value	4.1 A
• at 690 V rated value	3.3 A
Operating current	
• at 1 current path at DC-1	
— at 24 V rated value	20 A
— at 110 V rated value	2.1 A
— at 220 V rated value	0.8 A
— at 440 V rated value	0.6 A
— at 600 V rated value	0.6 A
• with 2 current paths in series at DC-1	
— at 24 V rated value	20 A
— at 110 V rated value	12 A
— at 220 V rated value	1.6 A
— at 440 V rated value	0.8 A
— at 600 V rated value	0.7 A
• with 3 current paths in series at DC-1	
— at 24 V rated value	20 A
— at 110 V rated value	20 A
— at 220 V rated value	20 A
— at 440 V rated value	1.3 A
— at 600 V rated value	1 A
Operating current	
• at 1 current path at DC-3 at DC-5	
— at 24 V rated value	20 A

<ul style="list-style-type: none"> — at 110 V rated value 	0.1 A
<ul style="list-style-type: none"> • with 2 current paths in series at DC-3 at DC-5 <ul style="list-style-type: none"> — at 24 V rated value — at 110 V rated value 	20 A 0.35 A
<ul style="list-style-type: none"> • with 3 current paths in series at DC-3 at DC-5 <ul style="list-style-type: none"> — at 24 V rated value — at 110 V rated value — at 220 V rated value — at 440 V rated value — at 600 V rated value 	20 A 20 A 1.5 A 0.2 A 0.2 A
Operating power	
<ul style="list-style-type: none"> • at AC-1 <ul style="list-style-type: none"> — at 230 V rated value — at 230 V at 60 °C rated value — at 400 V rated value — at 400 V at 60 °C rated value — at 690 V rated value — at 690 V at 60 °C rated value • at AC-2 at 400 V rated value • at AC-3 <ul style="list-style-type: none"> — at 230 V rated value — at 400 V rated value — at 500 V rated value — at 690 V rated value 	7.5 kW 7.5 kW 13 kW 13 kW 22 kW 22 kW 4 kW 2.2 kW 4 kW 4 kW 5.5 kW
Operating power for approx. 200000 operating cycles at AC-4	
<ul style="list-style-type: none"> • at 400 V rated value • at 690 V rated value 	2 kW 2.5 kW
No-load switching frequency	
<ul style="list-style-type: none"> • at DC 	10 000 1/h
Operating frequency	
<ul style="list-style-type: none"> • at AC-1 maximum • at AC-2 maximum • at AC-3 maximum • at AC-4 maximum 	1 000 1/h 750 1/h 750 1/h 250 1/h
Control circuit/ Control	
Type of voltage of the control supply voltage	DC
Control supply voltage at DC	
<ul style="list-style-type: none"> • rated value 	24 V
Operating range factor control supply voltage rated value of magnet coil at DC	

<ul style="list-style-type: none"> • initial value 	0.7
<ul style="list-style-type: none"> • Full-scale value 	1.25
Design of the surge suppressor	with suppressor diode
Closing power of magnet coil at DC	2.8 W
Holding power of magnet coil at DC	2.8 W
Closing delay	
<ul style="list-style-type: none"> • at DC 	30 ... 100 ms
Opening delay	
<ul style="list-style-type: none"> • at DC 	7 ... 13 ms
Arcing time	10 ... 15 ms
Control version of the switch operating mechanism	Standard A1 - A2

Auxiliary circuit

Number of NO contacts for auxiliary contacts	
<ul style="list-style-type: none"> • instantaneous contact 	1
Operating current at AC-12 maximum	10 A
Operating current at AC-15	
<ul style="list-style-type: none"> • at 230 V rated value 	10 A
<ul style="list-style-type: none"> • at 400 V rated value 	3 A
<ul style="list-style-type: none"> • at 500 V rated value 	2 A
<ul style="list-style-type: none"> • at 690 V rated value 	1 A
Operating current at DC-12	
<ul style="list-style-type: none"> • at 24 V rated value 	10 A
<ul style="list-style-type: none"> • at 48 V rated value 	6 A
<ul style="list-style-type: none"> • at 60 V rated value 	6 A
<ul style="list-style-type: none"> • at 110 V rated value 	3 A
<ul style="list-style-type: none"> • at 125 V rated value 	2 A
<ul style="list-style-type: none"> • at 220 V rated value 	1 A
<ul style="list-style-type: none"> • at 600 V rated value 	0.15 A
Operating current at DC-13	
<ul style="list-style-type: none"> • at 24 V rated value 	10 A
<ul style="list-style-type: none"> • at 48 V rated value 	2 A
<ul style="list-style-type: none"> • at 60 V rated value 	2 A
<ul style="list-style-type: none"> • at 110 V rated value 	1 A
<ul style="list-style-type: none"> • at 125 V rated value 	0.9 A
<ul style="list-style-type: none"> • at 220 V rated value 	0.3 A
<ul style="list-style-type: none"> • at 600 V rated value 	0.1 A
Contact reliability of auxiliary contacts	1 faulty switching per 100 million (17 V, 1 mA)

UL/CSA ratings

Full-load current (FLA) for three-phase AC motor	
<ul style="list-style-type: none"> • at 480 V rated value 	7.6 A
<ul style="list-style-type: none"> • at 600 V rated value 	9 A

Yielded mechanical performance [hp]	
<ul style="list-style-type: none"> • for single-phase AC motor <ul style="list-style-type: none"> — at 110/120 V rated value — at 230 V rated value • for three-phase AC motor <ul style="list-style-type: none"> — at 200/208 V rated value — at 220/230 V rated value — at 460/480 V rated value — at 575/600 V rated value 	<p>0.33 hp</p> <p>1 hp</p> <p>2 hp</p> <p>3 hp</p> <p>5 hp</p> <p>7.5 hp</p>
Contact rating of auxiliary contacts according to UL	A600 / Q600

Short-circuit protection

Design of the fuse link	
<ul style="list-style-type: none"> • for short-circuit protection of the main circuit <ul style="list-style-type: none"> — with type of coordination 1 required — with type of assignment 2 required • for short-circuit protection of the auxiliary switch required 	<p>gG: 35A (690V,100kA), aM: 20A (690V,100kA), BS88: 35A (415V,80kA)</p> <p>gG: 20A (690V,100kA), aM: 16A (690V, 100kA), BS88: 20A (415V, 80kA)</p> <p>gG: 10 A (500 V, 1 kA)</p>

Installation/ mounting/ dimensions

Mounting position	+/-180° rotation possible on vertical mounting surface; can be tilted forward and backward by +/- 22.5° on vertical mounting surface
Mounting type	screw and snap-on mounting onto 35 mm standard mounting rail according to DIN EN 60715
<ul style="list-style-type: none"> • Side-by-side mounting 	Yes
Height	58 mm
Width	45 mm
Depth	73 mm
Required spacing	
<ul style="list-style-type: none"> • with side-by-side mounting <ul style="list-style-type: none"> — forwards — upwards — downwards — at the side • for grounded parts <ul style="list-style-type: none"> — forwards — upwards — at the side — downwards • for live parts <ul style="list-style-type: none"> — forwards 	<p>10 mm</p> <p>10 mm</p> <p>10 mm</p> <p>0 mm</p> <p>10 mm</p> <p>10 mm</p> <p>6 mm</p> <p>10 mm</p> <p>10 mm</p>

— upwards	10 mm
— downwards	10 mm
— at the side	6 mm

Connections/ Terminals





Type of electrical connection <ul style="list-style-type: none"> • for main current circuit • for auxiliary and control current circuit • at contactor for auxiliary contacts • of magnet coil 	screw-type terminals screw-type terminals Screw-type terminals Screw-type terminals
Type of connectable conductor cross-sections <ul style="list-style-type: none"> • for main contacts <ul style="list-style-type: none"> — solid — single or multi-stranded — finely stranded with core end processing • at AWG conductors for main contacts 	2x (0.5 ... 1.5 mm ²), 2x (0.75 ... 2.5 mm ²), 2x 4 mm ² 2x (0,5 ... 1,5 mm ²), 2x (0,75 ... 2,5 mm ²), 2x 4 mm ² 2x (0.5 ... 1.5 mm ²), 2x (0.75 ... 2.5 mm ²) 2x (20 ... 16), 2x (18 ... 14), 2x 12
Connectable conductor cross-section for main contacts <ul style="list-style-type: none"> • solid • stranded • finely stranded with core end processing 	0.5 ... 4 mm ² 0.5 ... 4 mm ² 0.5 ... 2.5 mm ²
Connectable conductor cross-section for auxiliary contacts <ul style="list-style-type: none"> • single or multi-stranded • finely stranded with core end processing 	0.5 ... 4 mm ² 0.5 ... 2.5 mm ²
Type of connectable conductor cross-sections <ul style="list-style-type: none"> • for auxiliary contacts <ul style="list-style-type: none"> — single or multi-stranded — finely stranded with core end processing • at AWG conductors for auxiliary contacts 	2x (0,5 ... 1,5 mm ²), 2x (0,75 ... 2,5 mm ²), 2x 4 mm ² 2x (0.5 ... 1.5 mm ²), 2x (0.75 ... 2.5 mm ²) 2x (20 ... 16), 2x (18 ... 14), 2x 12
AWG number as coded connectable conductor cross section <ul style="list-style-type: none"> • for main contacts • for auxiliary contacts 	20 ... 12 20 ... 12

Safety related data

B10 value <ul style="list-style-type: none"> • with high demand rate acc. to SN 31920 	1 000 000
Proportion of dangerous failures <ul style="list-style-type: none"> • with low demand rate acc. to SN 31920 • with high demand rate acc. to SN 31920 	40 % 73 %
Failure rate [FIT] <ul style="list-style-type: none"> • with low demand rate acc. to SN 31920 	100 FIT

Product function	No
• Mirror contact acc. to IEC 60947-4-1	
T1 value for proof test interval or service life acc. to IEC 61508	20 y
Protection against electrical shock	finger-safe



Certificates/ approvals

General Product Approval					EMC
			KC		
CCC	CSA	UL			RCM

Functional Safety/Safety of Machinery	Declaration of Conformity	Test Certificates			
Type Examination Certificate		Miscellaneous	Type Test Certificates/Test Report	Special Test Certificate	Miscellaneous
	EG-Konf.				

Marine / Shipping



Marine / Shipping	other	Railway
	Confirmation	Special Test Certificate
		
	VDE	

Further information

Information- and Downloadcenter (Catalogs, Brochures,...)

www.siemens.com/sirius/catalogs

Industry Mall (Online ordering system)

<https://mall.industry.siemens.com/mall/en/en/Catalog/product?mlfb=3RT2016-1KB41>

Cax online generator

<http://support.automation.siemens.com/WW/CAXorder/default.aspx?lang=en&mlfb=3RT2016-1KB41>

Service&Support (Manuals, Certificates, Characteristics, FAQs,...)

<https://support.industry.siemens.com/cs/ww/en/ps/3RT2016-1KB41>

Image database (product images, 2D dimension drawings, 3D models, device circuit diagrams, EPLAN macros, ...)

http://www.automation.siemens.com/bilddb/cax_de.aspx?mlfb=3RT2016-1KB41&lang=en

Characteristic: Tripping characteristics, I²t, Let-through current
<https://support.industry.siemens.com/cs/ww/en/ps/3RT2016-1KB41/char>

Further characteristics (e.g. electrical endurance, switching frequency)
<http://www.automation.siemens.com/bilddb/index.aspx?view=Search&mlfb=3RT2016-1KB41&objecttype=14&gridview=view1>

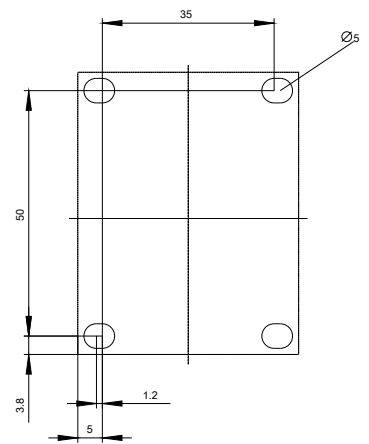
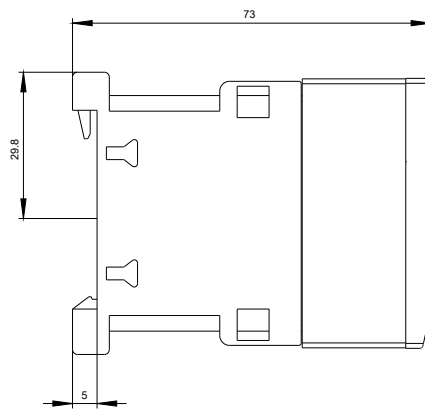
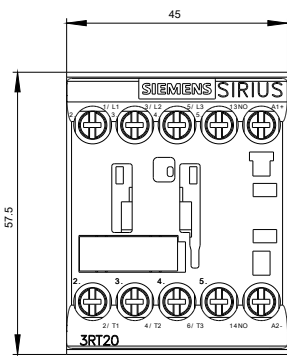

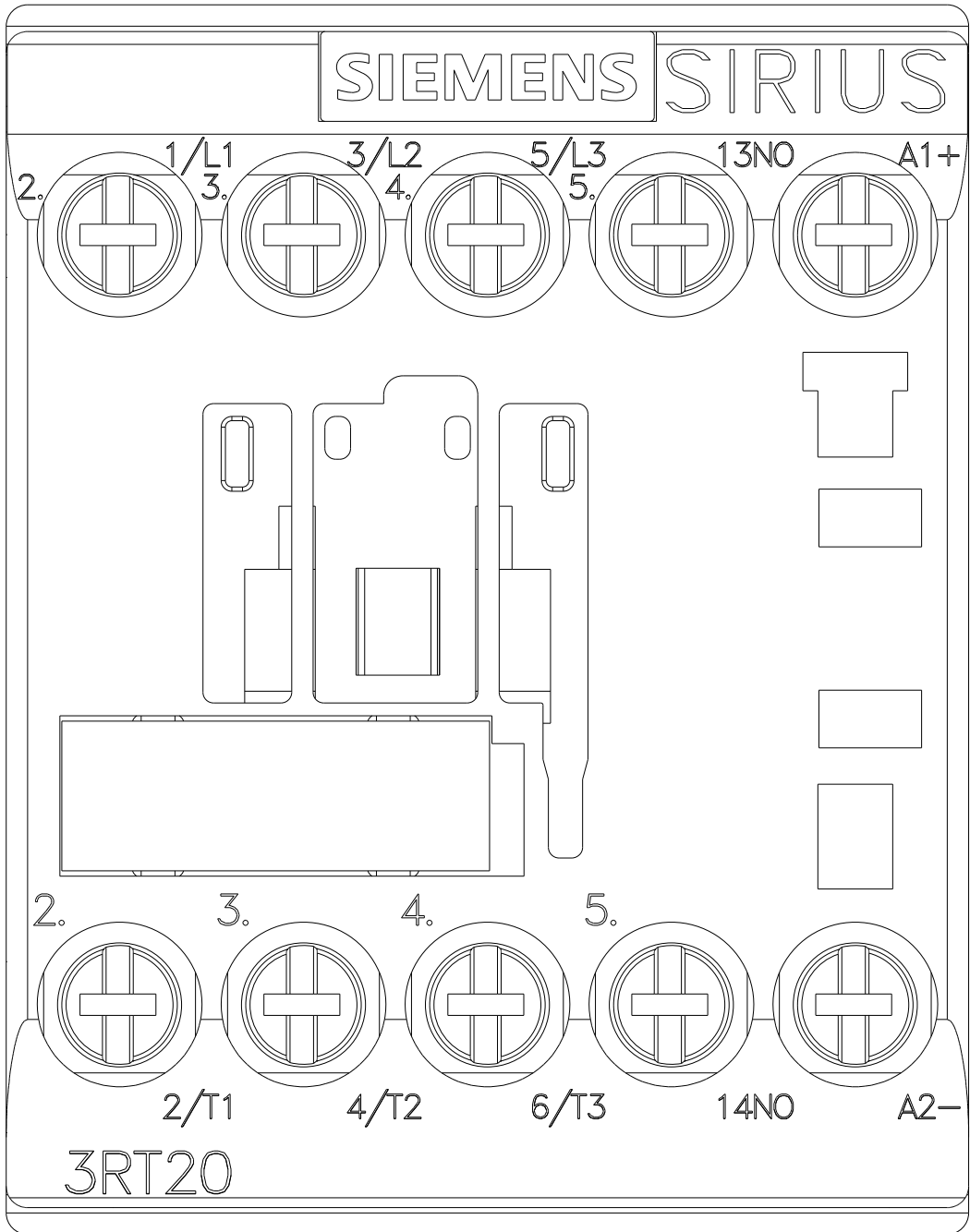

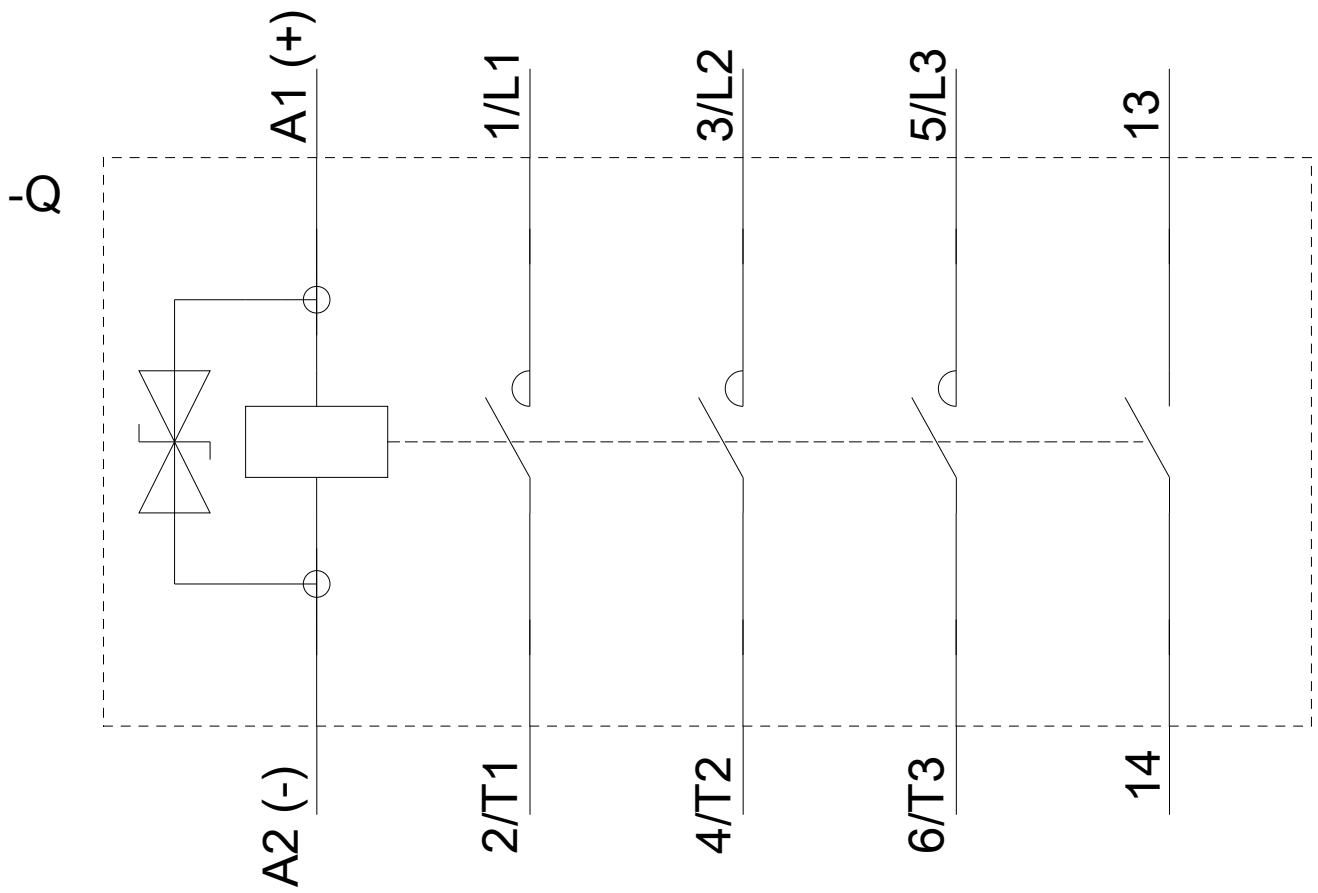

last modified:

11/19/2019