

Circuit breaker size S00 for starter combination Rated current 0.32 A
N-release 4.2 A screw terminal Standard switching capacity



Product brand name	SIRIUS
Product designation	Circuit breaker
Design of the product	For starter combinations
Product type designation	3RV2

General technical data	
Size of the circuit-breaker	S00
Size of contactor can be combined company-specific	S00, S0
Product extension	Yes
<ul style="list-style-type: none"> Auxiliary switch 	Yes
Power loss [W] for rated value of the current	
<ul style="list-style-type: none"> at AC in hot operating state 	5.5 W
<ul style="list-style-type: none"> at AC in hot operating state per pole 	1.8 W
Insulation voltage with degree of pollution 3 rated value	690 V
Surge voltage resistance rated value	6 kV
maximum permissible voltage for safe isolation	
<ul style="list-style-type: none"> in networks with grounded star point between main and auxiliary circuit 	400 V

<ul style="list-style-type: none"> in networks with grounded star point between main and auxiliary circuit 	400 V
Protection class IP	
<ul style="list-style-type: none"> on the front 	IP20
<ul style="list-style-type: none"> of the terminal 	IP20
Shock resistance	
<ul style="list-style-type: none"> acc. to IEC 60068-2-27 	25g / 11 ms
Mechanical service life (switching cycles)	
<ul style="list-style-type: none"> of the main contacts typical 	100 000
<ul style="list-style-type: none"> of auxiliary contacts typical 	100 000
Electrical endurance (switching cycles)	
<ul style="list-style-type: none"> typical 	100 000
Reference code acc. to DIN EN 81346-2	Q

Ambient conditions

Installation altitude at height above sea level	
<ul style="list-style-type: none"> maximum 	2 000 m
Ambient temperature	
<ul style="list-style-type: none"> during operation 	-20 ... +60 °C
<ul style="list-style-type: none"> during storage 	-50 ... +80 °C
<ul style="list-style-type: none"> during transport 	-50 ... +80 °C
Relative humidity during operation	10 ... 95 %

Main circuit

Number of poles for main current circuit	3
Operating voltage	
<ul style="list-style-type: none"> rated value 	690 V
<ul style="list-style-type: none"> at AC-3 rated value maximum 	690 V
Operating frequency rated value	50 ... 60 Hz
Operating current rated value	0.32 A
Operating current	
<ul style="list-style-type: none"> at AC-3 <ul style="list-style-type: none"> — at 400 V rated value 	0.32 A
Operating power	
<ul style="list-style-type: none"> at AC-3 <ul style="list-style-type: none"> — at 230 V rated value — at 400 V rated value — at 500 V rated value — at 690 V rated value 	40 W 90 W 120 W 120 W
Operating frequency	
<ul style="list-style-type: none"> at AC-3 maximum 	15 1/h

Auxiliary circuit

Number of NC contacts for auxiliary contacts	0
---	---

Number of NO contacts for auxiliary contacts	0
Number of CO contacts	
• for auxiliary contacts	0

Protective and monitoring functions

Product function	
• Ground fault detection	No
• Phase failure detection	No
Operational short-circuit current breaking capacity (Ics) at AC	
• at 240 V rated value	100 kA
• at 400 V rated value	100 kA
• at 500 V rated value	100 kA
• at 690 V rated value	100 kA
Maximum short-circuit current breaking capacity (Icu)	
• at AC at 240 V rated value	100 kA
• at AC at 400 V rated value	100 kA
• at AC at 500 V rated value	100 kA
• at AC at 690 V rated value	100 kA
Response value current	
• of instantaneous short-circuit trip unit	4.2 A

UL/CSA ratings

Full-load current (FLA) for three-phase AC motor	
• at 480 V rated value	0.32 A
• at 600 V rated value	0.32 A

Short-circuit protection

Product function Short circuit protection	Yes
Design of the short-circuit trip	magnetic

Installation/ mounting/ dimensions

Mounting position	any
Mounting type	screw and snap-on mounting onto 35 mm standard mounting rail according to DIN EN 60715
Height	97 mm
Width	45 mm
Depth	97 mm
Required spacing	
• with side-by-side mounting	
— forwards	0 mm
— Backwards	0 mm
— upwards	50 mm
— downwards	50 mm
— at the side	0 mm

- for grounded parts
 - forwards 0 mm
 - Backwards 0 mm
 - upwards 50 mm
 - at the side 30 mm
 - downwards 50 mm
- for live parts
 - forwards 0 mm
 - Backwards 0 mm
 - upwards 50 mm
 - downwards 50 mm
 - at the side 30 mm

0 mm
0 mm
50 mm
30 mm
50 mm
0 mm
0 mm
50 mm
50 mm
30 mm

Connections/ Terminals

Product function	
<ul style="list-style-type: none"> • removable terminal for auxiliary and control circuit 	No
Type of electrical connection	
<ul style="list-style-type: none"> • for main current circuit 	screw-type terminals
Arrangement of electrical connectors for main current circuit	Top and bottom
Type of connectable conductor cross-sections	
<ul style="list-style-type: none"> • for main contacts <ul style="list-style-type: none"> — single or multi-stranded — finely stranded with core end processing • at AWG conductors for main contacts 	2x (0,75 ... 2,5 mm ²), 2x 4 mm ² 2x (0.5 ... 1.5 mm ²), 2x (0.75 ... 2.5 mm ²) 2x (18 ... 14), 2x 12
Tightening torque	
<ul style="list-style-type: none"> • for main contacts with screw-type terminals 	0.8 ... 1.2 N·m
Design of screwdriver shaft	Diameter 5 to 6 mm
Size of the screwdriver tip	Pozidriv 2
Design of the thread of the connection screw	
<ul style="list-style-type: none"> • for main contacts 	M3





Safety related data



B10 value	
<ul style="list-style-type: none"> • with high demand rate acc. to SN 31920 	5 000
Proportion of dangerous failures	
<ul style="list-style-type: none"> • with low demand rate acc. to SN 31920 • with high demand rate acc. to SN 31920 	50 % 50 %
Failure rate [FIT]	
<ul style="list-style-type: none"> • with low demand rate acc. to SN 31920 	50 FIT
T1 value for proof test interval or service life acc. to IEC 61508	10 y
Display version	





- for switching status

Handle

Certificates/ approvals

General Product Approval				Declaration of Conformity	
			KC		
CCC	CSA	UL		EAC	EG-Konf.

Declaration of Conformity	Test Certificates	Marine / Shipping			
Miscellaneous	Type Test Certificates/Test Report	Special Test Certificate			
			ABS	BUREAU VERITAS	LRS

Marine / Shipping				other	
				Confirmation	
PRS	RINA	RMRS	DNV-GL DNVGL.COM/AF		VDE

Railway	
Vibration and Shock	Confirmation

Further information

Information- and Downloadcenter (Catalogs, Brochures,...)

www.siemens.com/sirius/catalogs

Industry Mall (Online ordering system)

<https://mall.industry.siemens.com/mall/en/en/Catalog/product?mlfb=3RV2311-0DC10>

Cax online generator

<http://support.automation.siemens.com/WW/CAXorder/default.aspx?lang=en&mlfb=3RV2311-0DC10>

Service&Support (Manuals, Certificates, Characteristics, FAQs,...)

<https://support.industry.siemens.com/cs/ww/en/ps/3RV2311-0DC10>

Image database (product images, 2D dimension drawings, 3D models, device circuit diagrams, EPLAN macros, ...)

http://www.automation.siemens.com/bilddb/cax_de.aspx?mlfb=3RV2311-0DC10&lang=en

Characteristic: Tripping characteristics, I^t, Let-through current

<https://support.industry.siemens.com/cs/ww/en/ps/3RV2311-0DC10/char>

Further characteristics (e.g. electrical endurance, switching frequency)

<http://www.automation.siemens.com/bilddb/index.aspx?view=Search&mlfb=3RV2311-0DC10&objecttype=14&gridview=view1>

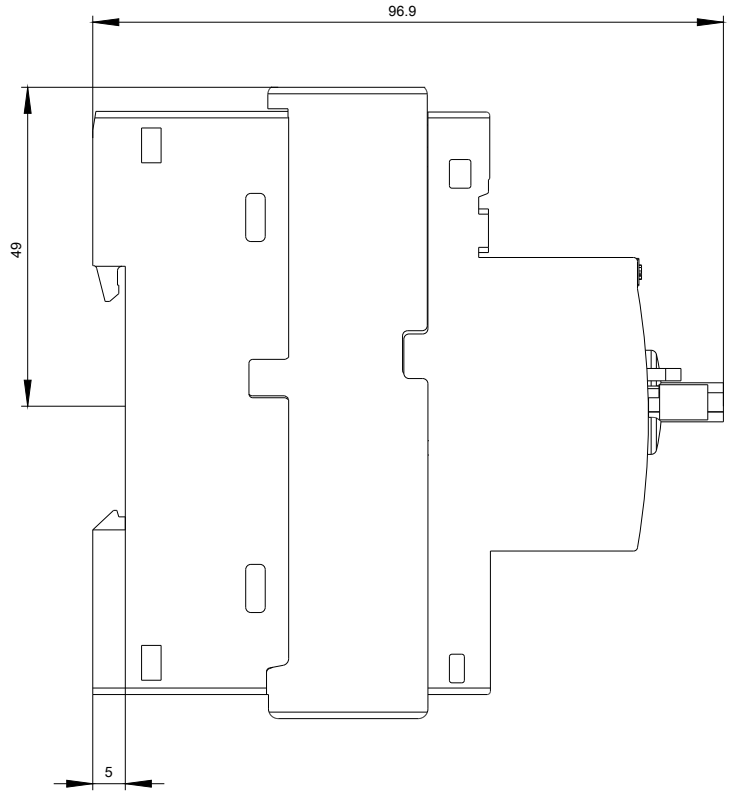
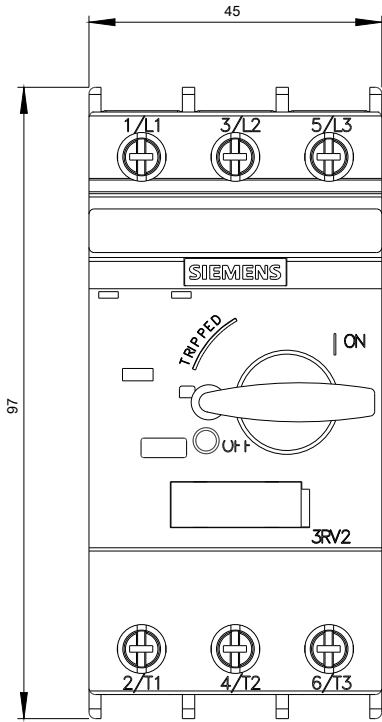

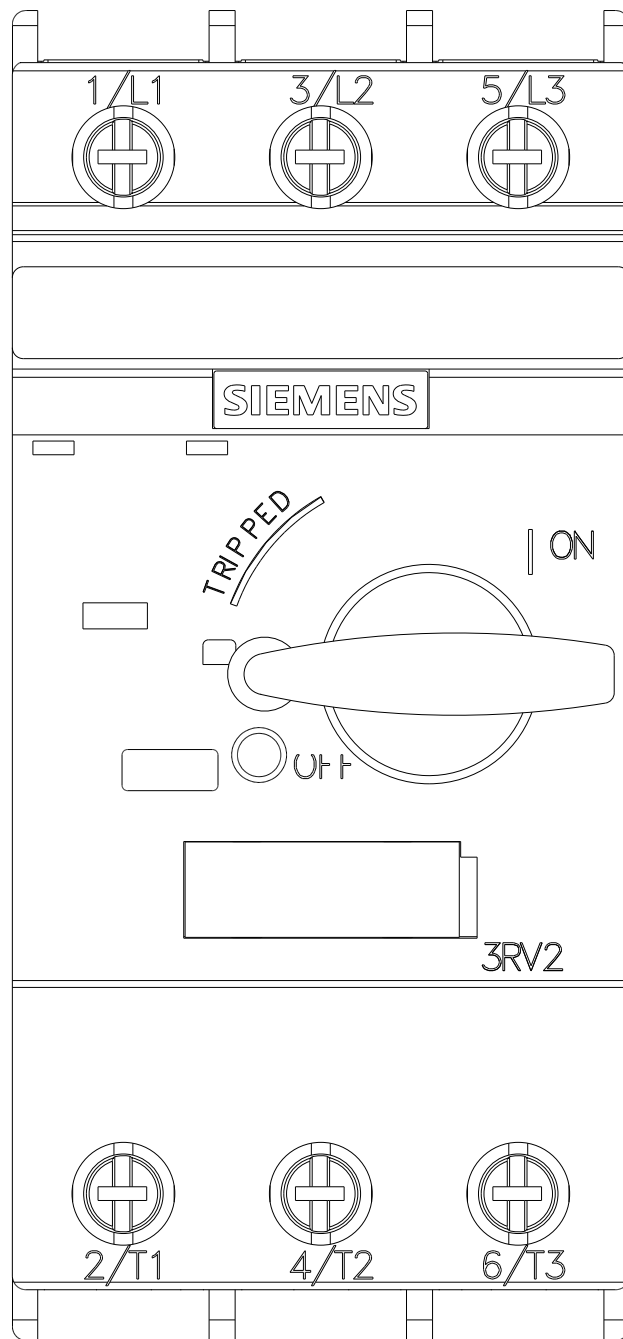

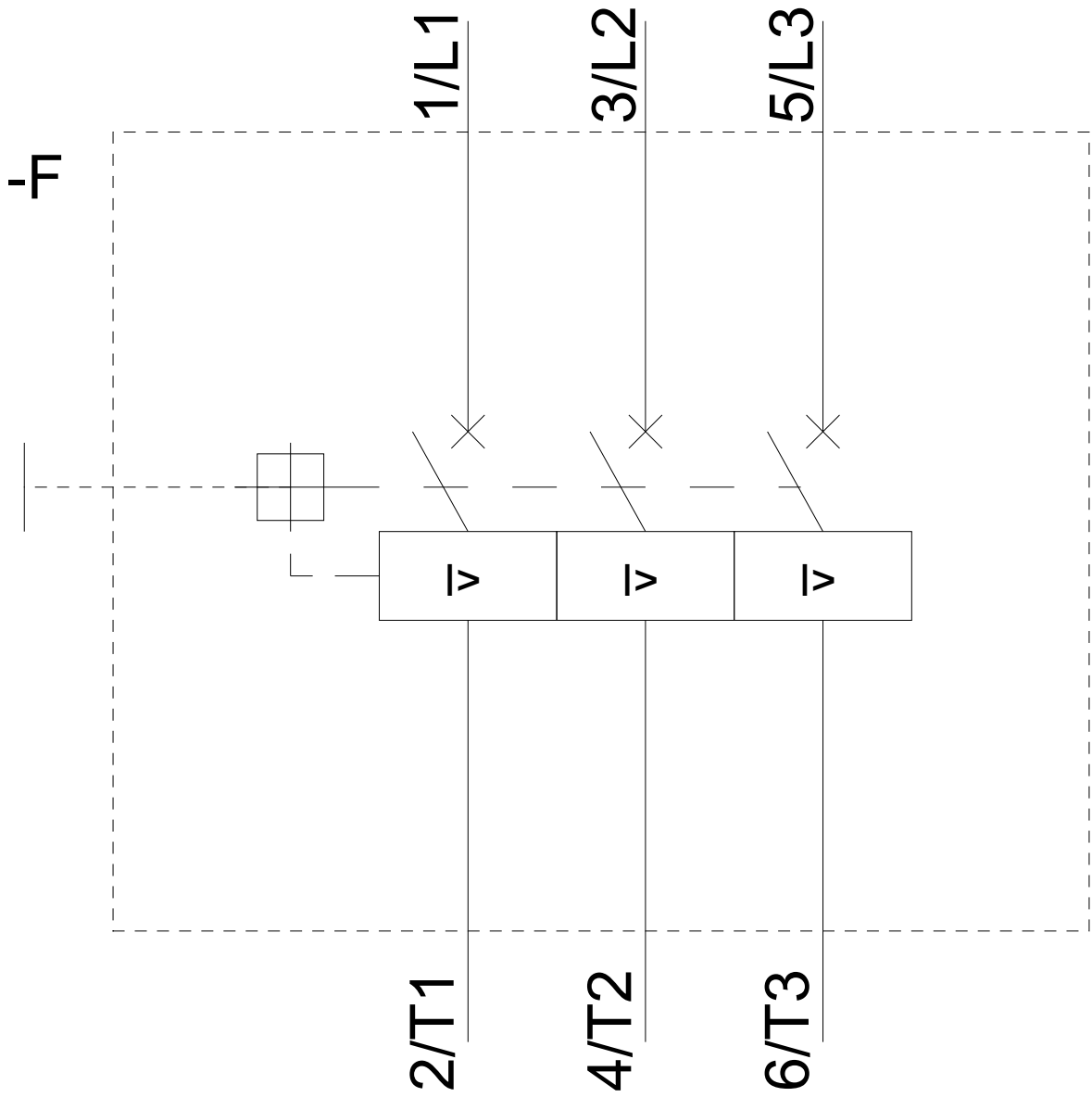

last modified:

11/19/2019