

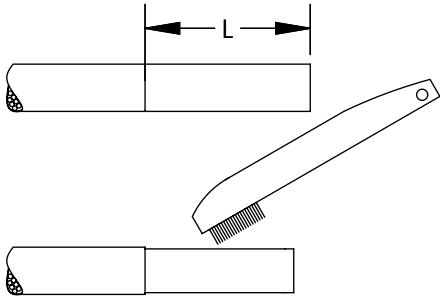

284-PC



**CU
ONLY**

**NO
AL**

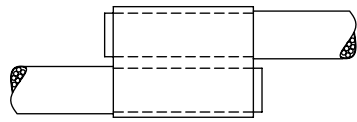
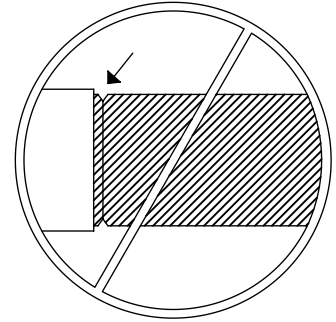

(OR)

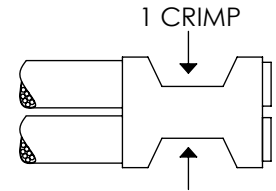
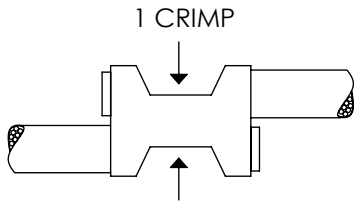
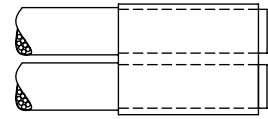

HEAT SHRINK INSTALLATION INSTRUCTIONS

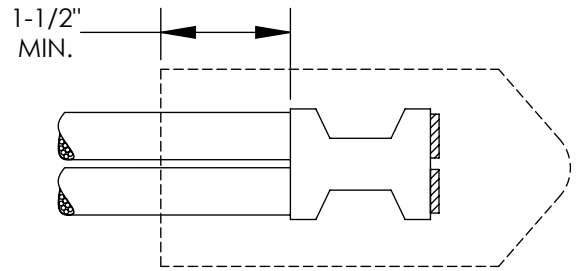
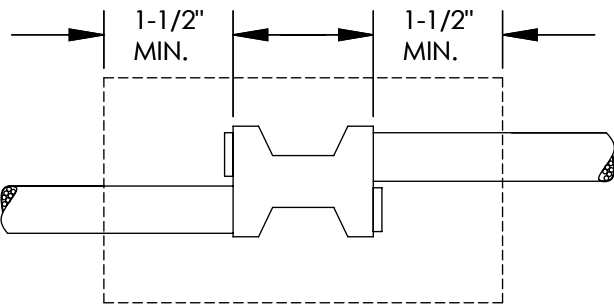

(OR)

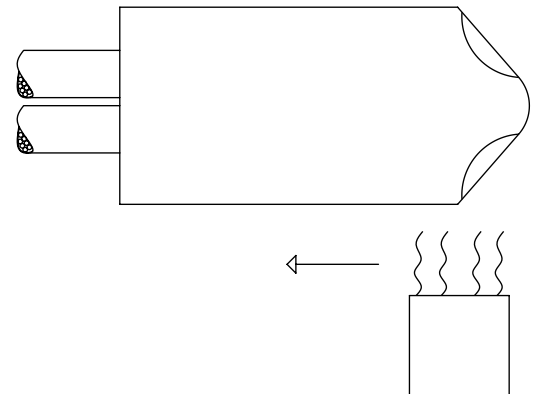
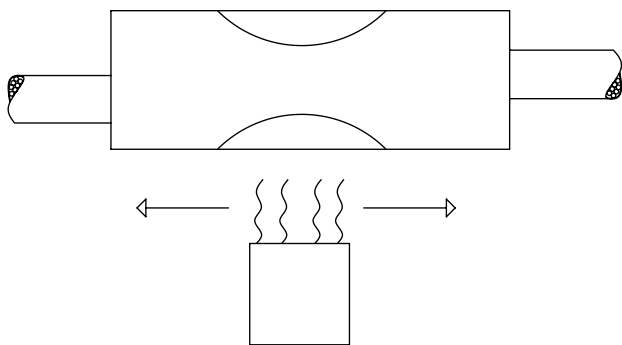

Tool Chart for Compression Connectors Type PSC with Compact & Code Class B Copper Cable

SQUARE COLOR	PANDUIT PART NUMBER	L WIRE STRIP LENGTH (In.)	AWG STR CU WIRE RANGE	PANDUIT TOOL PART NUMBER			RECOMMENDED HEAT SHRINK END CAP	RECOMMENDED THICK WALL HEAT SHRINK
				DIE COLOR, INDEX NUMBER (CRIMPS PER CONNECTOR)				
				CT-980 CT-980CH CT-2950 CT-2980 CT-2981	CT-2001 CT-2002	CT-920, CT-930, CT-2940* CT-920CH, CT-930CH, CT-940CH* CT-2920, CT-2930 CT-2931		
	PSCRED-L	7/16	#12-#10	---	CD-2001-8 RED P21 (1)	CD-920-8 RED P21 (1)	HSECFR0.5-X	HST0.4-6-3
	PSCBLU-L	7/16	#12-#6	---	CD-2001-6 BLUE P24 (1)	CD-920-6 BLUE P24 (1)		
	PSCGRY-L	7/16	#12-#4	(1)	CD-2001-4 GRAY P29 (1)	CD-920-4 GRAY P29 (1)		
	PSCBRN-L	11/16	#12-#2	(1)	CD-2001-2 BROWN P33 (1)	CD-920-2 BROWN P33 (1)	HSECFR0.8-X	HST0.8-6-3
	PSCGRN-L	11/16	#12-#1	(1)	CD-2001-1 GREEN P37 (1)	CD-920-1 GREEN P37 (1)		
	PSCPNK-L	11/16	#12-1/0	(1)	CD-2001-1/0 PINK P42 (1)	CD-920-1/0 PINK P42 (1)		
	PSCBLK-Q	7/8	#12-2/0	(1)	CD-2001-2/0 BLACK P45 (1)	CD-920-2/0 BLACK P45 (1)	HSECFR1.0-X	HST1.1-6-3
	PSCORG-Q	7/8	#12-3/0	(1)	CD-2001-3/0 ORANGE P50 (1)	CD-920-3/0 ORANGE P50 (1)		
	PSCPUR-Q	1	#12-3/0	(1)	CD-2001-4/0 PURPLE P54 (1)	CD-920-4/0 PURPLE P54 (1)		
	PSCYEL-Q	1-1/16	#12-3/0	(1)	CD-2001-250 YELLOW P62 (1)	CD-920-250 YELLOW P62 (1)		

* CD-920 dies can be used with CT-940CH tool and CT-2940 tool with CD-940-DA adapter. Compact stranding is #8 AWG to 3/0 AWG only.



		#14	#12	#10	#8	#6	#4	#2	#1	1/0	2/0	3/0
		1 2 3	1 2 3	1 2 3	1 2 3	1 2 3	1 2 3	1 2 3	1 2 3	1 2 3	1 2 3	1 2 3
#14	1	-	-	-	-	-	-	-	-	-	-	-
	2	-	-	-	-	-	-	-	-	-	-	-
	3	-	-	-	-	-	-	-	-	-	-	-
#12	1	-	-	-	-	-	-	-	-	-	-	-
	2	-	-	-	-	-	-	-	-	-	-	-
	3	-	-	-	-	-	-	-	-	-	-	-
#10	1	-	-	-	-	-	-	-	-	-	-	-
	2	-	-	-	-	-	-	-	-	-	-	-
	3	-	-	-	-	-	-	-	-	-	-	-
#8	1	-	-	-	-	-	-	-	-	-	-	-
	2	-	-	-	-	-	-	-	-	-	-	-
	3	-	-	-	-	-	-	-	-	-	-	-
#6	1	-	-	-	-	-	-	-	-	-	-	-
	2	-	-	-	-	-	-	-	-	-	-	-
	3	-	-	-	-	-	-	-	-	-	-	-
#4	1	-	-	-	-	-	-	-	-	-	-	-
	2	-	-	-	-	-	-	-	-	-	-	-
	3	-	-	-	-	-	-	-	-	-	-	-
#2	1	-	-	-	-	-	-	-	-	-	-	-
	2	-	-	-	-	-	-	-	-	-	-	-
	3	-	-	-	-	-	-	-	-	-	-	-
#1	1	-	-	-	-	-	-	-	-	-	-	-
	2	-	-	-	-	-	-	-	-	-	-	-
	3	-	-	-	-	-	-	-	-	-	-	-
1/0	1	-	-	-	-	-	-	-	-	-	-	-
	2	-	-	-	-	-	-	-	-	-	-	-
	3	-	-	-	-	-	-	-	-	-	-	-
2/0	1	-	-	-	-	-	-	-	-	-	-	-
	2	-	-	-	-	-	-	-	-	-	-	-
	3	-	-	-	-	-	-	-	-	-	-	-
3/0	1	-	-	-	-	-	-	-	-	-	-	-
	2	-	-	-	-	-	-	-	-	-	-	-
	3	-	-	-	-	-	-	-	-	-	-	-

The colored boxes indicate a UL Listed wire combination for that color PSC splice. The numbers 1, 2, & 3 next to each wire size on the left & top edges indicates wire quantities for that wire size. Match the top wire size/quantities with the sidw wire size/quantities to determine the correct part to use for a wire combination.

For Instructions in Local Languages and Technical Support:

techsupport@panduit.com



www.panduit.com

E-mail: cs@panduit.com

Phone: 800-777-3300