

Reversing contactor assembly, AC-3, 30 kW 400 V, 24 V AC, 50/60 Hz 3-pole, Size S2 screw terminal electrical and mechanical interlock 2 NO integrated



<b>Product brand name</b>	SIRIUS
<b>Product designation</b>	Reversing contactor assembly
<b>Product type designation</b>	3RA23
<b>Manufacturer's article number</b>	<ul style="list-style-type: none"> <li>• 1 of the supplied contactor <a href="#">3RT2037-1AG20</a></li> <li>• 2 of the supplied contactor <a href="#">3RT2037-1AG20</a></li> <li>• of the supplied RS assembly kit <a href="#">3RA2933-2AA1</a></li> </ul>

General technical data	
<b>Size of contactor</b>	S2
<b>Product extension</b>	Yes
<ul style="list-style-type: none"> <li>• Auxiliary switch</li> </ul>	
<b>Insulation voltage</b>	690 V
<ul style="list-style-type: none"> <li>• with degree of pollution 3 at AC rated value</li> </ul>	
<b>Degree of pollution</b>	3
<b>Surge voltage resistance rated value</b>	6 kV
<b>Protection class IP</b>	IP20
<ul style="list-style-type: none"> <li>• on the front</li> </ul>	
<b>Shock resistance at rectangular impulse</b>	11.8g / 5 ms, 11.6g / 10 ms
<ul style="list-style-type: none"> <li>• at AC</li> </ul>	

<b>Shock resistance with sine pulse</b>	
<ul style="list-style-type: none"> <li>• at AC</li> </ul>	18.5g / 5 ms, 11.6g / 10 ms
<b>Mechanical service life (switching cycles)</b>	
<ul style="list-style-type: none"> <li>• of contactor typical</li> </ul>	10 000 000
<ul style="list-style-type: none"> <li>• of the contactor with added auxiliary switch block typical</li> </ul>	10 000 000
<b>Reference code acc. to DIN EN 81346-2</b>	Q

### Ambient conditions

<b>Installation altitude at height above sea level</b>	
<ul style="list-style-type: none"> <li>• maximum</li> </ul>	2 000 m
<b>Ambient temperature</b>	
<ul style="list-style-type: none"> <li>• during operation</li> </ul>	-25 ... +60 °C
<ul style="list-style-type: none"> <li>• during storage</li> </ul>	-55 ... +80 °C

### Main circuit

<b>Number of poles for main current circuit</b>	3
<b>Number of NO contacts for main contacts</b>	3
<b>Number of NC contacts for main contacts</b>	0
<b>Operating voltage</b>	
<ul style="list-style-type: none"> <li>• at AC-3 rated value maximum</li> </ul>	690 V
<b>Operating current</b>	
<ul style="list-style-type: none"> <li>• at AC-1 at 400 V <ul style="list-style-type: none"> <li>— at ambient temperature 40 °C rated value</li> <li>— at ambient temperature 60 °C rated value</li> </ul> </li> <li>• at AC-2 at 400 V rated value</li> <li>• at AC-3 <ul style="list-style-type: none"> <li>— at 400 V rated value</li> </ul> </li> </ul>	80 A 70 A 65 A 65 A
<b>Operating current</b>	
<ul style="list-style-type: none"> <li>• at 1 current path at DC-1 <ul style="list-style-type: none"> <li>— at 24 V rated value</li> <li>— at 110 V rated value</li> </ul> </li> <li>• with 2 current paths in series at DC-1 <ul style="list-style-type: none"> <li>— at 24 V rated value</li> <li>— at 110 V rated value</li> </ul> </li> <li>• with 3 current paths in series at DC-1 <ul style="list-style-type: none"> <li>— at 24 V rated value</li> <li>— at 110 V rated value</li> </ul> </li> </ul>	55 A 4.5 A 55 A 25 A 55 A 55 A
<b>Operating current</b>	
<ul style="list-style-type: none"> <li>• at 1 current path at DC-3 at DC-5 <ul style="list-style-type: none"> <li>— at 24 V rated value</li> <li>— at 110 V rated value</li> </ul> </li> <li>• with 2 current paths in series at DC-3 at DC-5</li> </ul>	35 A 2.5 A

<ul style="list-style-type: none"> <li>— at 24 V rated value</li> <li>— at 110 V rated value</li> <li>• with 3 current paths in series at DC-3 at DC-5 <ul style="list-style-type: none"> <li>— at 24 V rated value</li> <li>— at 110 V rated value</li> </ul> </li> </ul>	55 A 25 A 55 A 55 A
<b>Operating power</b>	
<ul style="list-style-type: none"> <li>• at AC-2 at 400 V rated value</li> <li>• at AC-3 <ul style="list-style-type: none"> <li>— at 400 V rated value</li> <li>— at 690 V rated value</li> </ul> </li> <li>• at AC-4 at 400 V rated value</li> </ul>	30 kW 30 kW 37 kW 30 kW
<b>No-load switching frequency</b>	1 500 1/h
<b>Operating frequency</b>	
<ul style="list-style-type: none"> <li>• at AC-1 maximum</li> <li>• at AC-2 maximum</li> <li>• at AC-3 maximum</li> <li>• at AC-4 maximum</li> </ul>	800 1/h 400 1/h 700 1/h 200 1/h

<b>Control circuit/ Control</b>	
<b>Type of voltage of the control supply voltage</b>	AC
<b>Control supply voltage 1 at AC</b>	
<ul style="list-style-type: none"> <li>• at 50 Hz rated value</li> <li>• at 60 Hz rated value</li> </ul>	24 V 24 V
<b>Operating range factor control supply voltage rated value of magnet coil at AC</b>	
<ul style="list-style-type: none"> <li>• at 50 Hz</li> <li>• at 60 Hz</li> </ul>	0.8 ... 1.1 0.85 ... 1.1
<b>Apparent pick-up power of magnet coil at AC</b>	
<ul style="list-style-type: none"> <li>• at 50 Hz</li> <li>• at 60 Hz</li> </ul>	210 V·A 188 V·A
<b>Inductive power factor with closing power of the coil</b>	
<ul style="list-style-type: none"> <li>• at 50 Hz</li> <li>• at 60 Hz</li> </ul>	0.69 0.65
<b>Apparent holding power of magnet coil at AC</b>	
<ul style="list-style-type: none"> <li>• at 50 Hz</li> <li>• at 60 Hz</li> </ul>	17.2 V·A 16.5 V·A
<b>Inductive power factor with the holding power of the coil</b>	
<ul style="list-style-type: none"> <li>• at 50 Hz</li> <li>• at 60 Hz</li> </ul>	0.36 0.39

<b>Auxiliary circuit</b>	
<b>Number of NC contacts for auxiliary contacts</b>	

<ul style="list-style-type: none"> <li>• per direction of rotation</li> </ul>	0
<b>Number of NO contacts for auxiliary contacts</b>	
<ul style="list-style-type: none"> <li>• per direction of rotation</li> </ul>	1
<b>Operating current of auxiliary contacts at AC-12 maximum</b>	10 A
<b>Operating current of auxiliary contacts at AC-15</b>	
<ul style="list-style-type: none"> <li>• at 230 V</li> </ul>	6 A
<ul style="list-style-type: none"> <li>• at 400 V</li> </ul>	3 A
<b>Operating current of auxiliary contacts at DC-13</b>	
<ul style="list-style-type: none"> <li>• at 24 V</li> </ul>	10 A
<ul style="list-style-type: none"> <li>• at 60 V</li> </ul>	2 A
<ul style="list-style-type: none"> <li>• at 110 V</li> </ul>	1 A
<ul style="list-style-type: none"> <li>• at 220 V</li> </ul>	0.3 A
<b>Contact reliability of auxiliary contacts</b>	< 1 error per 100 million operating cycles

### UL/CSA ratings

<b>Full-load current (FLA) for three-phase AC motor</b>	
<ul style="list-style-type: none"> <li>• at 480 V rated value</li> </ul>	65 A
<ul style="list-style-type: none"> <li>• at 600 V rated value</li> </ul>	62 A
<b>Yielded mechanical performance [hp]</b>	
<ul style="list-style-type: none"> <li>• for single-phase AC motor <ul style="list-style-type: none"> <li>— at 110/120 V rated value</li> <li>— at 230 V rated value</li> </ul> </li> </ul>	5 hp 10 hp
<ul style="list-style-type: none"> <li>• for three-phase AC motor <ul style="list-style-type: none"> <li>— at 220/230 V rated value</li> <li>— at 460/480 V rated value</li> <li>— at 575/600 V rated value</li> </ul> </li> </ul>	20 hp 50 hp 50 hp
<b>Contact rating of auxiliary contacts according to UL</b>	A600 / Q600

### Short-circuit protection

<b>Design of the fuse link</b>	
<ul style="list-style-type: none"> <li>• for short-circuit protection of the main circuit <ul style="list-style-type: none"> <li>— with type of coordination 1 required</li> <li>— with type of assignment 2 required</li> </ul> </li> <li>• for short-circuit protection of the auxiliary switch required</li> </ul>	gG NH 3NA, DIAZED 5SB, NEOZED 5SE: 250 A gG NH 3NA, DIAZED 5SB, NEOZED 5SE: 125 A fuse gG: 10 A

### Installation/ mounting/ dimensions

<b>Mounting position</b>	+/-180° rotation possible on vertical mounting surface; can be tilted forward and backward by +/- 22.5° on vertical mounting surface
<b>Mounting type</b>	screw and snap-on mounting onto 35 mm standard mounting rail
<b>Height</b>	141 mm
<b>Width</b>	120 mm

<b>Depth</b>	130 mm
<b>Required spacing</b>	
<ul style="list-style-type: none"> <li>• with side-by-side mounting <ul style="list-style-type: none"> <li>— forwards 10 mm</li> <li>— Backwards 0 mm</li> <li>— upwards 10 mm</li> <li>— downwards 10 mm</li> <li>— at the side 10 mm</li> </ul> </li> <li>• for grounded parts <ul style="list-style-type: none"> <li>— forwards 10 mm</li> <li>— Backwards 0 mm</li> <li>— upwards 10 mm</li> <li>— at the side 10 mm</li> <li>— downwards 10 mm</li> </ul> </li> <li>• for live parts <ul style="list-style-type: none"> <li>— forwards 10 mm</li> <li>— Backwards 0 mm</li> <li>— upwards 10 mm</li> <li>— downwards 10 mm</li> <li>— at the side 10 mm</li> </ul> </li> </ul>	

### Connections/ Terminals

<b>Type of electrical connection</b>	
<ul style="list-style-type: none"> <li>• for main current circuit screw-type terminals</li> <li>• for auxiliary and control current circuit screw-type terminals</li> </ul>	
<b>Type of connectable conductor cross-sections</b>	
<ul style="list-style-type: none"> <li>• for main contacts <ul style="list-style-type: none"> <li>— solid 2x (1 ... 35 mm<sup>2</sup>), 1x (1 ... 50 mm<sup>2</sup>)</li> <li>— single or multi-stranded 2x (1 ... 35 mm<sup>2</sup>), 1x (1 ... 50 mm<sup>2</sup>)</li> <li>— finely stranded with core end processing 2x (1 ... 25 mm<sup>2</sup>), 1x (1 ... 35 mm<sup>2</sup>)</li> </ul> </li> <li>• at AWG conductors for main contacts 2x (18 ... 2), 1x (18 ... 1)</li> </ul>	
<b>Type of connectable conductor cross-sections</b>	
<ul style="list-style-type: none"> <li>• for auxiliary contacts <ul style="list-style-type: none"> <li>— single or multi-stranded 2x (0,5 ... 1,5 mm<sup>2</sup>), 2x (0,75 ... 2,5 mm<sup>2</sup>)</li> <li>— finely stranded with core end processing 2x (0.5 ... 1.5 mm<sup>2</sup>), 2x (0.75 ... 2.5 mm<sup>2</sup>)</li> </ul> </li> <li>• at AWG conductors for auxiliary contacts 2x (20 ... 16), 2x (18 ... 14)</li> </ul>	

### Safety related data





<b>B10 value</b>	
<ul style="list-style-type: none"> <li>• with high demand rate acc. to SN 31920 1 000 000</li> </ul>	
<b>Proportion of dangerous failures</b>	
<ul style="list-style-type: none"> <li>• with low demand rate acc. to SN 31920 40 %</li> <li>• with high demand rate acc. to SN 31920 73 %</li> </ul>	

<b>Failure rate [FIT]</b>	
<ul style="list-style-type: none"> <li>with low demand rate acc. to SN 31920</li> </ul>	100 FIT
<b>T1 value for proof test interval or service life acc. to IEC 61508</b>	20 y

#### Communication/ Protocol

<b>Product function Bus communication</b>	No
<b>Protocol is supported</b>	
<ul style="list-style-type: none"> <li>AS-Interface protocol</li> </ul>	No
<b>Product function Control circuit interface with IO link</b>	No

#### Certificates/ approvals

General Product Approval	Declaration of Conformity	Test Certificates
 CSA  UL  EAC  EG-Konf.	<a href="#">Miscellaneous</a>	<a href="#">Type Test Certificates/Test Report</a>

#### Marine / Shipping



<b>Marine / Shipping</b>	<b>other</b>
--------------------------	--------------



[Confirmation](#)

#### Further information

**Information- and Downloadcenter (Catalogs, Brochures,...)**

[www.siemens.com/ic10](http://www.siemens.com/ic10)

**Industry Mall (Online ordering system)**

<https://mall.industry.siemens.com/mall/en/en/Catalog/product?mlfb=3RA2337-8XB30-1AC2>

**Cax online generator**

<http://support.automation.siemens.com/WW/CAXorder/default.aspx?lang=en&mlfb=3RA2337-8XB30-1AC2>

**Service&Support (Manuals, Certificates, Characteristics, FAQs,...)**

<https://support.industry.siemens.com/cs/ww/en/ps/3RA2337-8XB30-1AC2>

**Image database (product images, 2D dimension drawings, 3D models, device circuit diagrams, EPLAN macros, ...)**

[http://www.automation.siemens.com/bilddb/cax\\_de.aspx?mlfb=3RA2337-8XB30-1AC2&lang=en](http://www.automation.siemens.com/bilddb/cax_de.aspx?mlfb=3RA2337-8XB30-1AC2&lang=en)

**Characteristic: Tripping characteristics, I<sup>2</sup>t, Let-through current**

<https://support.industry.siemens.com/cs/ww/en/ps/3RA2337-8XB30-1AC2/char>

**Further characteristics (e.g. electrical endurance, switching frequency)**

<http://www.automation.siemens.com/bilddb/index.aspx?view=Search&mlfb=3RA2337-8XB30-1AC2&objecttype=14&gridview=view1>

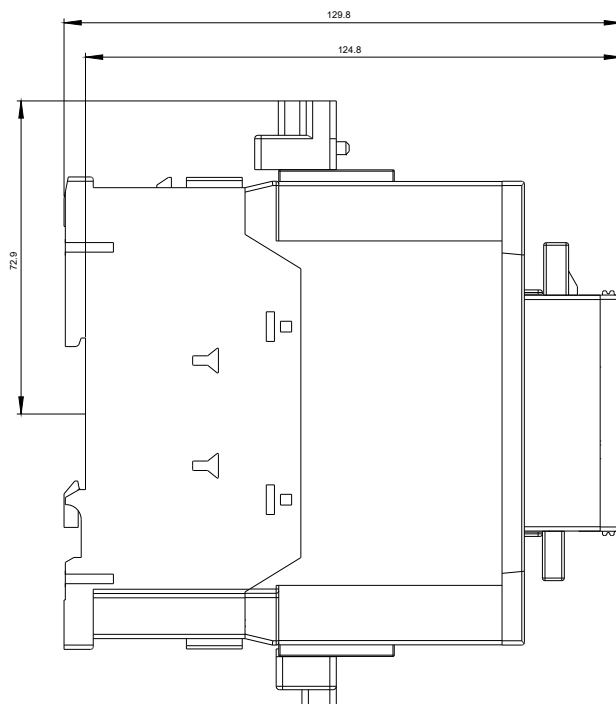
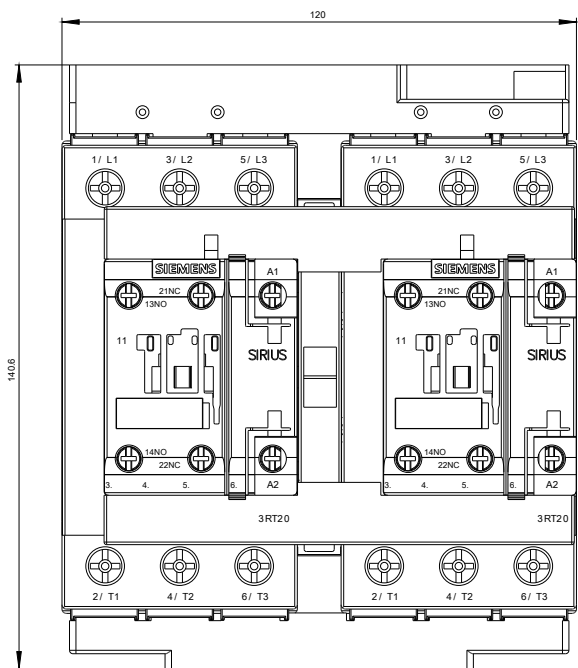

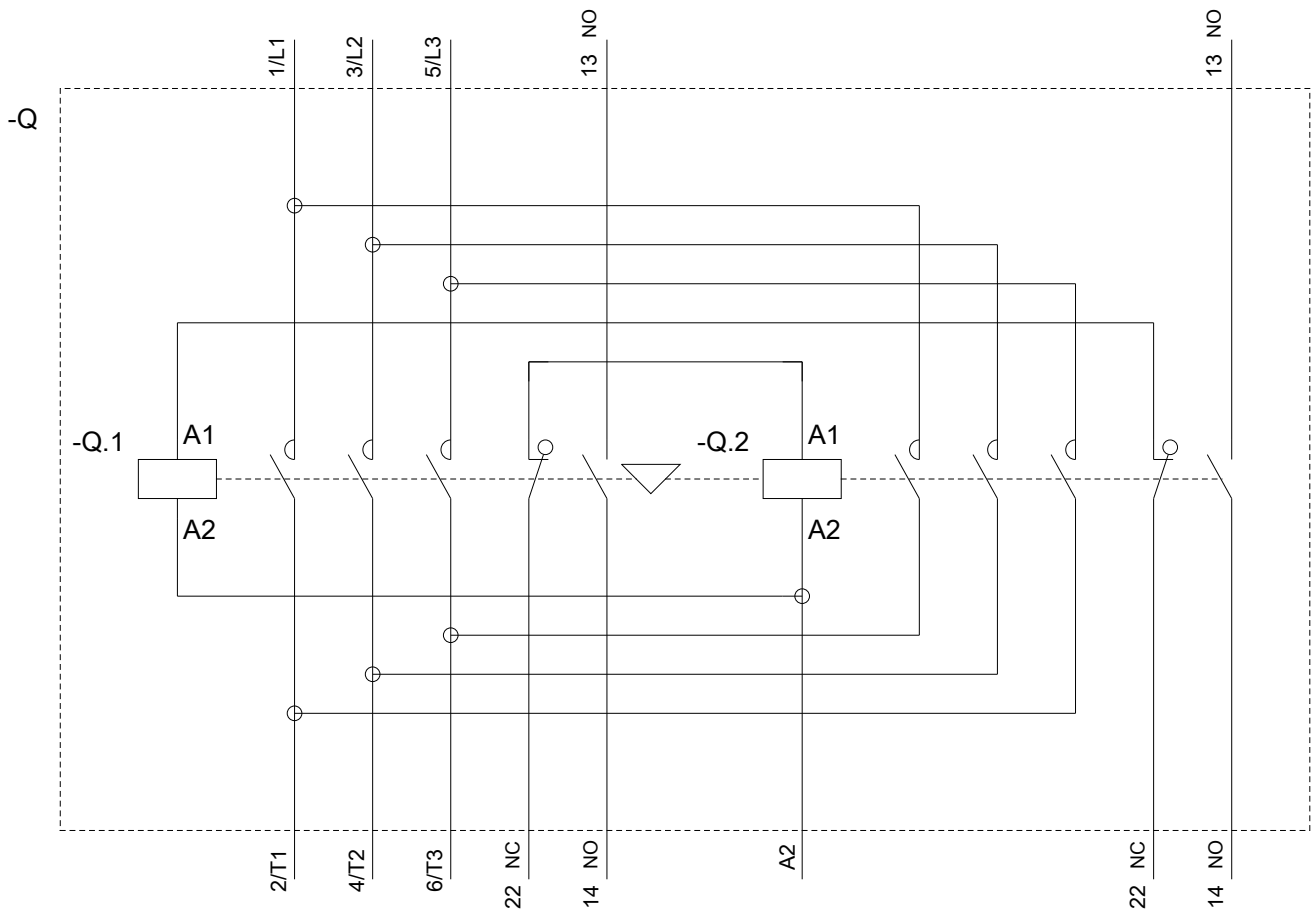

last modified:

02/06/2020