

Circuit breaker size S00 for transformer protection A-release
0.11...0.16 A N-release 3.3 A Spring-type terminal Standard
switching capacity



Product brand name	SIRIUS
Product designation	Circuit breaker
Design of the product	For transformer protection
Product type designation	3RV2

General technical data	
Size of the circuit-breaker	S00
Size of contactor can be combined company-specific	S00, S0
Product extension	Yes
<ul style="list-style-type: none"> Auxiliary switch 	Yes
Power loss [W] for rated value of the current	
<ul style="list-style-type: none"> at AC in hot operating state 	5.5 W
<ul style="list-style-type: none"> at AC in hot operating state per pole 	1.8 W
Insulation voltage with degree of pollution 3 rated value	690 V
Surge voltage resistance rated value	6 kV
maximum permissible voltage for safe isolation	
<ul style="list-style-type: none"> in networks with grounded star point between main and auxiliary circuit 	400 V

<ul style="list-style-type: none"> • in networks with grounded star point between main and auxiliary circuit 	400 V
Protection class IP	
<ul style="list-style-type: none"> • on the front 	IP20
<ul style="list-style-type: none"> • of the terminal 	IP20
Shock resistance	
<ul style="list-style-type: none"> • acc. to IEC 60068-2-27 	25g / 11 ms
Mechanical service life (switching cycles)	
<ul style="list-style-type: none"> • of the main contacts typical 	100 000
<ul style="list-style-type: none"> • of auxiliary contacts typical 	100 000
Electrical endurance (switching cycles)	
<ul style="list-style-type: none"> • typical 	100 000
Reference code acc. to DIN EN 81346-2	Q

Ambient conditions

Installation altitude at height above sea level	
<ul style="list-style-type: none"> • maximum 	2 000 m
Ambient temperature	
<ul style="list-style-type: none"> • during operation 	-20 ... +60 °C
<ul style="list-style-type: none"> • during storage 	-50 ... +80 °C
<ul style="list-style-type: none"> • during transport 	-50 ... +80 °C
Temperature compensation	-20 ... +60 °C
Relative humidity during operation	10 ... 95 %

Main circuit

Number of poles for main current circuit	3
Adjustable pick-up value current of the current-dependent overload release	0.11 ... 0.16 A
Operating voltage	
<ul style="list-style-type: none"> • rated value 	690 V
<ul style="list-style-type: none"> • at AC-3 rated value maximum 	690 V
Operating frequency rated value	50 ... 60 Hz
Operating current rated value	0.16 A
Operating current	
<ul style="list-style-type: none"> • at AC-3 <ul style="list-style-type: none"> — at 400 V rated value 	0.16 A
Operating power	
<ul style="list-style-type: none"> • at AC-3 <ul style="list-style-type: none"> — at 230 V rated value — at 400 V rated value — at 500 V rated value — at 690 V rated value 	20 W 40 W 60 W 60 W
Operating frequency	
<ul style="list-style-type: none"> • at AC-3 maximum 	15 1/h

Auxiliary circuit	
Number of NC contacts for auxiliary contacts	0
Number of NO contacts for auxiliary contacts	0
Number of CO contacts	
• for auxiliary contacts	0
Protective and monitoring functions	
Product function	
• Ground fault detection	No
• Phase failure detection	Yes
Trip class	CLASS 10
Design of the overload release	thermal
Operational short-circuit current breaking capacity (Ics) at AC	
• at 240 V rated value	100 kA
• at 400 V rated value	100 kA
• at 500 V rated value	100 kA
• at 690 V rated value	100 kA
Maximum short-circuit current breaking capacity (Icu)	
• at AC at 240 V rated value	100 kA
• at AC at 400 V rated value	100 kA
• at AC at 500 V rated value	100 kA
• at AC at 690 V rated value	100 kA
Response value current	
• of instantaneous short-circuit trip unit	3.3 A
UL/CSA ratings	
Full-load current (FLA) for three-phase AC motor	
• at 480 V rated value	0.16 A
• at 600 V rated value	0.16 A
Short-circuit protection	
Product function Short circuit protection	Yes
Design of the short-circuit trip	magnetic
Installation/ mounting/ dimensions	
Mounting position	any
Mounting type	screw and snap-on mounting onto 35 mm standard mounting rail according to DIN EN 60715
Height	106 mm
Width	45 mm
Depth	97 mm
Required spacing	
• with side-by-side mounting	
— forwards	0 mm

— Backwards	0 mm
— upwards	50 mm
— downwards	50 mm
— at the side	0 mm
• for grounded parts	
— forwards	0 mm
— Backwards	0 mm
— upwards	50 mm
— at the side	30 mm
— downwards	50 mm
• for live parts	
— forwards	0 mm
— Backwards	0 mm
— upwards	50 mm
— downwards	50 mm
— at the side	30 mm

Connections/ Terminals

Product function	
• removable terminal for auxiliary and control circuit	No
Type of electrical connection	
• for main current circuit	spring-loaded terminals
Arrangement of electrical connectors for main current circuit	Top and bottom
Type of connectable conductor cross-sections	
• for main contacts	
— single or multi-stranded	2x (0,5 ... 4 mm ²)
— finely stranded with core end processing	2x (0.5 ... 2.5 mm ²)
— finely stranded without core end processing	2x (0.5 ... 2.5 mm ²)
• at AWG conductors for main contacts	2x (20 ... 12)
Design of screwdriver shaft	Diameter 3 mm
Size of the screwdriver tip	3,0 x 0,5 mm

Safety related data





B10 value	
• with high demand rate acc. to SN 31920	5 000
Proportion of dangerous failures	
• with low demand rate acc. to SN 31920	50 %
• with high demand rate acc. to SN 31920	50 %
Failure rate [FIT]	
• with low demand rate acc. to SN 31920	50 FIT

T1 value for proof test interval or service life acc. to IEC 61508	10 y
Display version	Handle
<ul style="list-style-type: none"> for switching status 	

Certificates/ approvals

General Product Approval				Declaration of Conformity	
 CCC	 CSA	 UL		 EG-Konf.	Miscellaneous

Test Certificates	Marine / Shipping				
Special Test Certificate	Type Test Certificates/Test Report	 ABS	 BUREAU VERITAS	 LRS	 PRS

Marine / Shipping	other	Railway
 RINA	 DNV-GL DNVGL.COM/AF	 VDE
 RMRS	Confirmation	Vibration and Shock

Railway
Confirmation

Further information

Information- and Downloadcenter (Catalogs, Brochures,...)

www.siemens.com/sirius/catalogs

Industry Mall (Online ordering system)

<https://mall.industry.siemens.com/mall/en/en/Catalog/product?mlfb=3RV2411-0AA20>

Cax online generator

<http://support.automation.siemens.com/WW/CAXorder/default.aspx?lang=en&mlfb=3RV2411-0AA20>

Service&Support (Manuals, Certificates, Characteristics, FAQs,...)

<https://support.industry.siemens.com/cs/ww/en/ps/3RV2411-0AA20>

Image database (product images, 2D dimension drawings, 3D models, device circuit diagrams, EPLAN macros, ...)

http://www.automation.siemens.com/bilddb/cax_de.aspx?mlfb=3RV2411-0AA20&lang=en

Characteristic: Tripping characteristics, I²t, Let-through current

<https://support.industry.siemens.com/cs/ww/en/ps/3RV2411-0AA20/char>

Further characteristics (e.g. electrical endurance, switching frequency)

<http://www.automation.siemens.com/bilddb/index.aspx?view=Search&mlfb=3RV2411-0AA20&objecttype=14&gridview=view1>

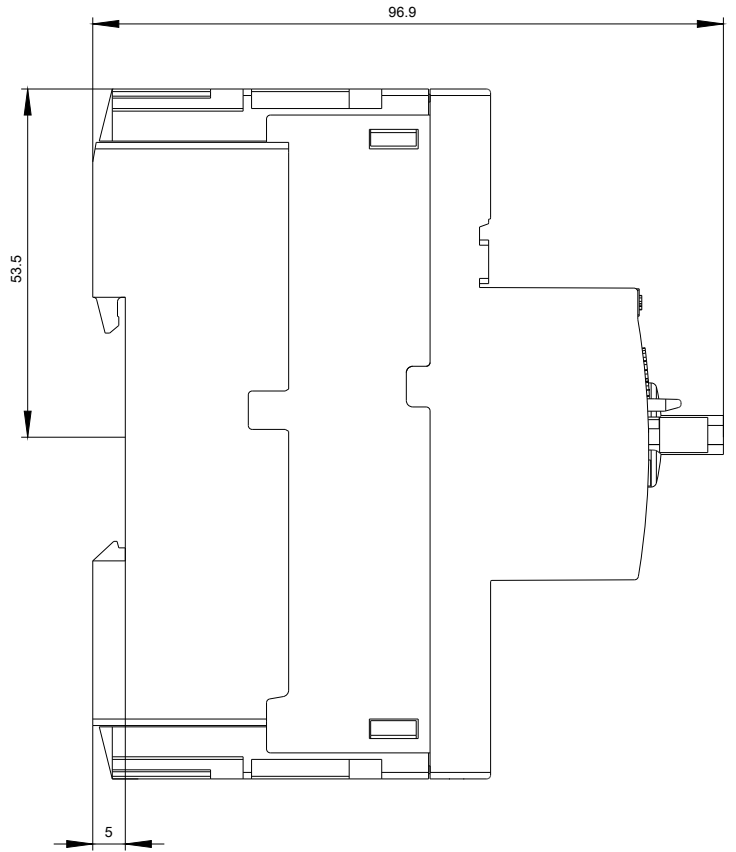
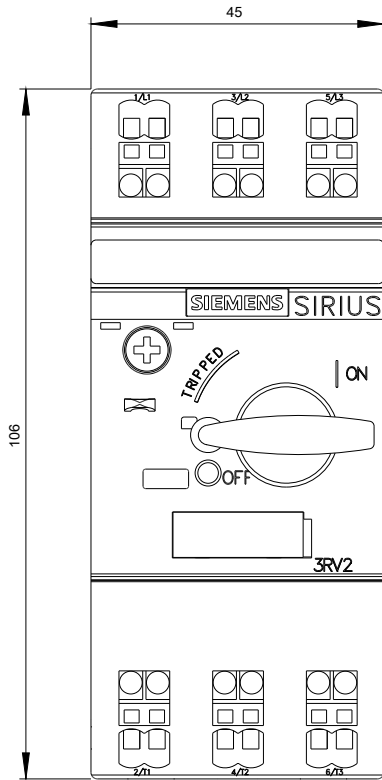

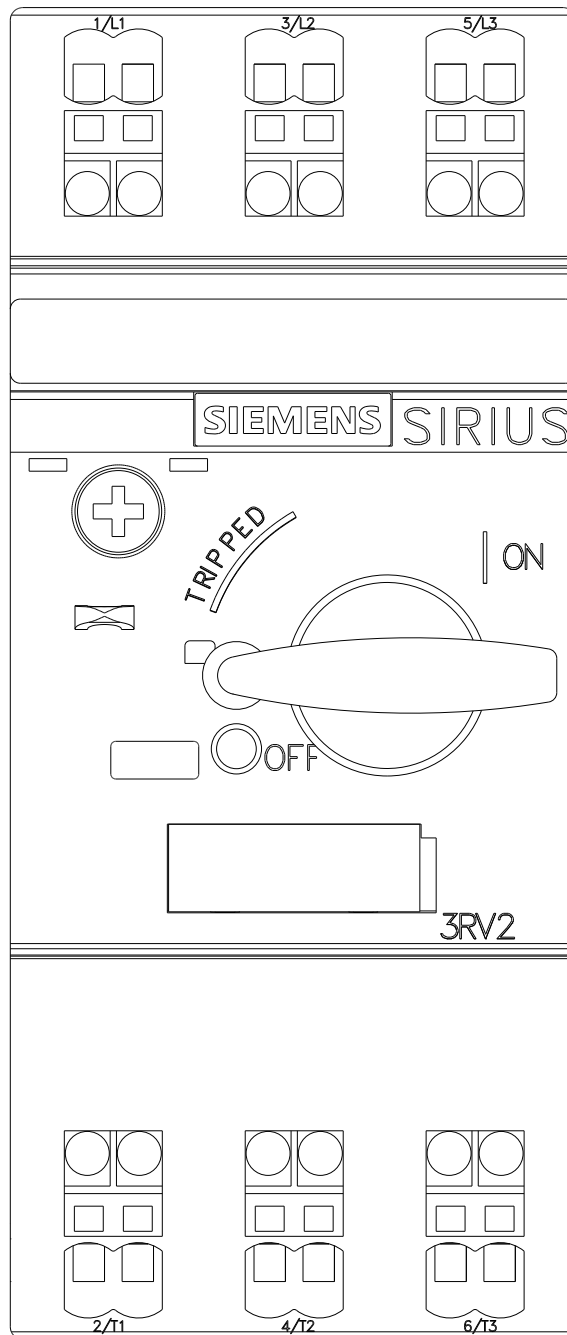

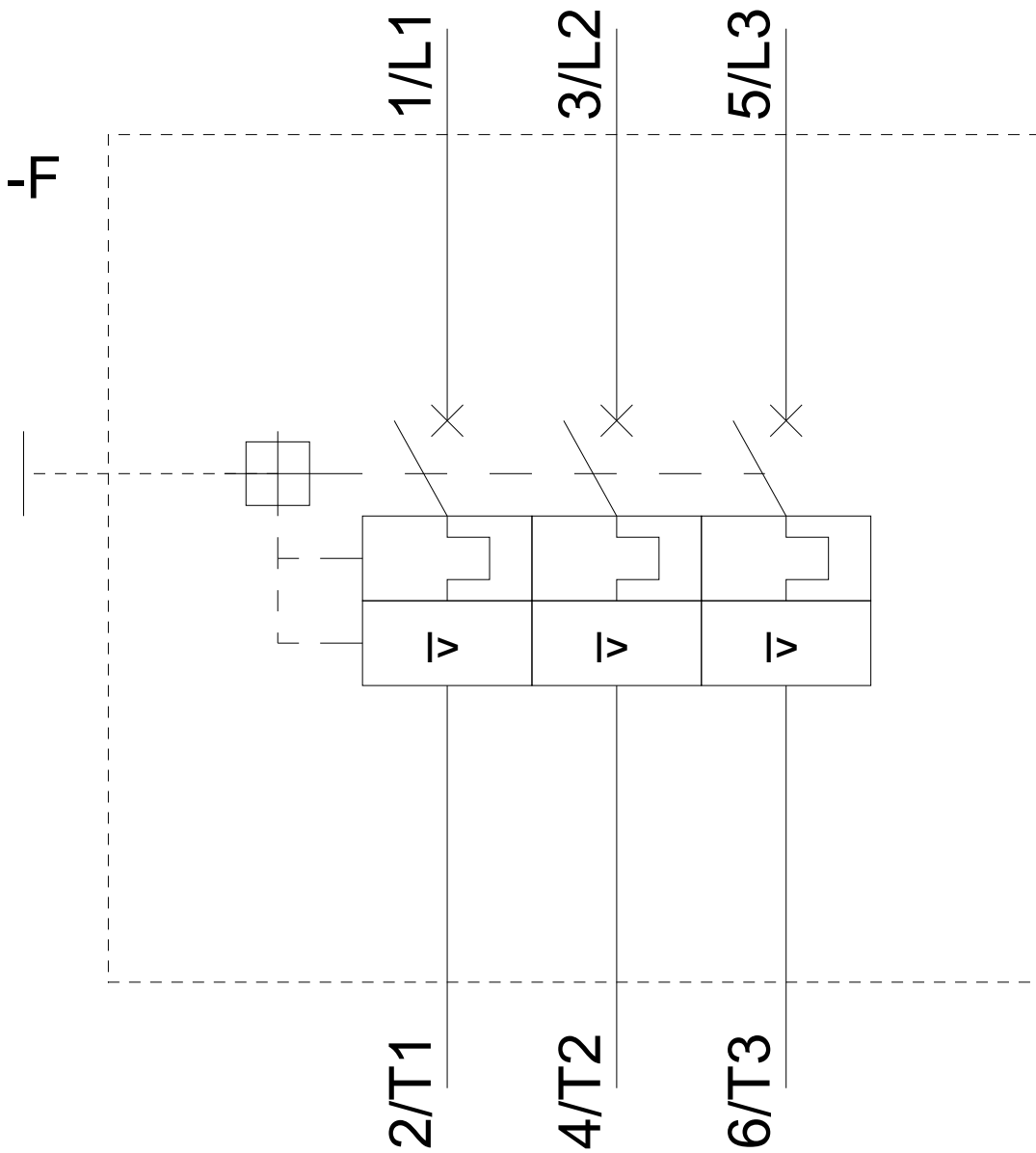

last modified:

11/19/2019