



digital monitoring relay current, active current, voltage, cos-phi and performance monitoring up to 690 V AC/DC up to 10 A supply voltage 24 ... 240 V AC/DC, 50 ... 60 Hz ON delay and tripping delay 0.1..999.9 s 2 changeover contacts screw terminal

product brand name	SIRIUS
product designation	Network monitoring relay with digital setting
design of the product	monitoring of current, active current, voltage, power factor and power, externally powered with auxiliary voltage
product type designation	3UG5
General technical data	
product function	network monitoring relay with digital setting
design of the display	LCD
insulation voltage for overvoltage category III according to IEC 60664	
• with degree of pollution 2 rated value	690 V
• with degree of pollution 3 rated value	690 V
degree of pollution	3
surge voltage resistance rated value	6 kV
shock resistance according to IEC 60068-2-27	sinusoidal half-wave 15g / 11 ms
vibration resistance according to IEC 60068-2-6	f = 4 ... 5,81 Hz, dmax = 15 mm; f = 5,81 ... 500 Hz, Amax = 20 m/s ² ; 10 cycles
mechanical service life (operating cycles) typical	10 000 000
electrical endurance (operating cycles) at AC-15 at 230 V typical	100 000
thermal current of the switching element with contacts maximum	5 A
reference code according to IEC 81346-2	K
Substance Prohibitance (Date)	06/01/2023
SVHC substance name	Lead - 7439-92-1 Lead monoxide (lead oxide) - 1317-36-8 6,6'-di-tert-butyl-2,2'-methylenedi-p-cresol - 119-47-1
Weight	0.19 kg
Product Function	
product function	
• overcurrent detection 1 phase	Yes
• undercurrent detection 1 phase	Yes
• adjustable open/closed-circuit current principle	Yes
Control circuit/ Control	
type of voltage of the control supply voltage	AC/DC
control supply voltage rated value	24 ... 240 V
control supply voltage at AC	
• at 50 Hz rated value	24 ... 240 V
• at 60 Hz rated value	24 ... 240 V
control supply voltage at DC rated value	24 ... 240 V
operating range factor control supply voltage rated value at DC	
• initial value	0.85





<ul style="list-style-type: none"> • full-scale value 	1.1
operating range factor control supply voltage rated value at AC at 50 Hz	
<ul style="list-style-type: none"> • initial value 	0.85
<ul style="list-style-type: none"> • full-scale value 	1.1
operating range factor control supply voltage rated value at AC at 60 Hz	
<ul style="list-style-type: none"> • initial value 	0.85
<ul style="list-style-type: none"> • full-scale value 	1.1
Supply voltage	
supply voltage frequency rated value	60 ... 50 Hz
Measuring circuit	
type of current for monitoring	AC/DC
measurable current	0.003 ... 10 A
measurable voltage at AC	0.1 ... 760 V
adjustable current response value current limited to 5 s	15 A
adjustable response delay time	
<ul style="list-style-type: none"> • when starting 	0 ... 999.9 s
<ul style="list-style-type: none"> • with lower or upper limit violation 	0 ... 999.9 s
adjustable switching hysteresis for measured current value	0 ... 5 000 mA
accuracy of digital display	+/-1 digit
Communication/ Protocol	
protocol is supported IO-Link protocol	No
Auxiliary circuit	
number of CO contacts delayed switching	2
Main circuit	
number of poles for main current circuit	1
operating voltage rated value	24 ... 240 V
ampacity of the output relay at AC-15	
<ul style="list-style-type: none"> • at 250 V at 50/60 Hz 	3 A
<ul style="list-style-type: none"> • at 400 V at 50/60 Hz 	3 A
ampacity of the output relay at DC-13	
<ul style="list-style-type: none"> • at 24 V 	1 A
<ul style="list-style-type: none"> • at 125 V 	0.2 A
<ul style="list-style-type: none"> • at 250 V 	0.1 A
operational current at 17 V minimum	5 mA
continuous current of the DIAZED fuse link of the output relay	6 A
Galvanic isolation	
galvanic isolation	
<ul style="list-style-type: none"> • between input and output 	Yes
<ul style="list-style-type: none"> • between the outputs 	Yes
<ul style="list-style-type: none"> • between the voltage supply and other circuits 	Yes
Connections/ Terminals	
product component removable terminal for auxiliary and control circuit	Yes
type of electrical connection	screw terminal
type of connectable conductor cross-sections	
<ul style="list-style-type: none"> • solid 	1x (0.5 ... 4 mm ²), 2x (0.5 ... 2.5 mm ²)
<ul style="list-style-type: none"> • for AWG cables solid 	1x (20 ... 12), 2x (20 ... 14)
connectable conductor cross-section	
<ul style="list-style-type: none"> • solid 	0.5 ... 4 mm ²
<ul style="list-style-type: none"> • finely stranded with core end processing 	0.5 ... 4 mm ²
AWG number as coded connectable conductor cross section	
<ul style="list-style-type: none"> • solid 	20 ... 12
<ul style="list-style-type: none"> • stranded 	20 ... 12
tightening torque with screw-type terminals	0.6 ... 0.8 N·m
Installation/ mounting/ dimensions	
mounting position	any
fastening method	screw and snap-on mounting
height	100 mm

width	22.5 mm
depth	90 mm
required spacing	
<ul style="list-style-type: none"> • with side-by-side mounting <ul style="list-style-type: none"> — forwards 0 mm — backwards 0 mm — upwards 0 mm — downwards 0 mm — at the side 0 mm • for grounded parts <ul style="list-style-type: none"> — forwards 0 mm — backwards 0 mm — upwards 0 mm — at the side 0 mm — downwards 0 mm • for live parts <ul style="list-style-type: none"> — forwards 0 mm — backwards 0 mm — upwards 0 mm — downwards 0 mm — at the side 0 mm 	

Ambient conditions

installation altitude at height above sea level maximum	2 000 m
ambient temperature	
<ul style="list-style-type: none"> • during operation -25 ... +60 °C • during storage -40 ... +80 °C • during transport -40 ... +80 °C 	

Approvals Certificates

General Product Approval	other	Environment
		
	Declaration of Conformity	Confirmation
		

Further information

Information on the packaging
<https://support.industry.siemens.com/cs/ww/en/view/109813875>

Information- and Downloadcenter (Catalogs, Brochures,...)
<https://www.siemens.com/ic10>

Industry Mall (Online ordering system)
<https://mall.industry.siemens.com/mall/en/en/Catalog/product?mlfb=3UG5642-1CW30>

Cax online generator
<http://support.automation.siemens.com/WW/CAXorder/default.aspx?lang=en&mlfb=3UG5642-1CW30>

Service&Support (Manuals, Certificates, Characteristics, FAQs,...)
<https://support.industry.siemens.com/cs/ww/en/ps/3UG5642-1CW30>

Image database (product images, 2D dimension drawings, 3D models, device circuit diagrams, EPLAN macros, ...)
http://www.automation.siemens.com/bilddb/cax_de.aspx?mlfb=3UG5642-1CW30&lang=en

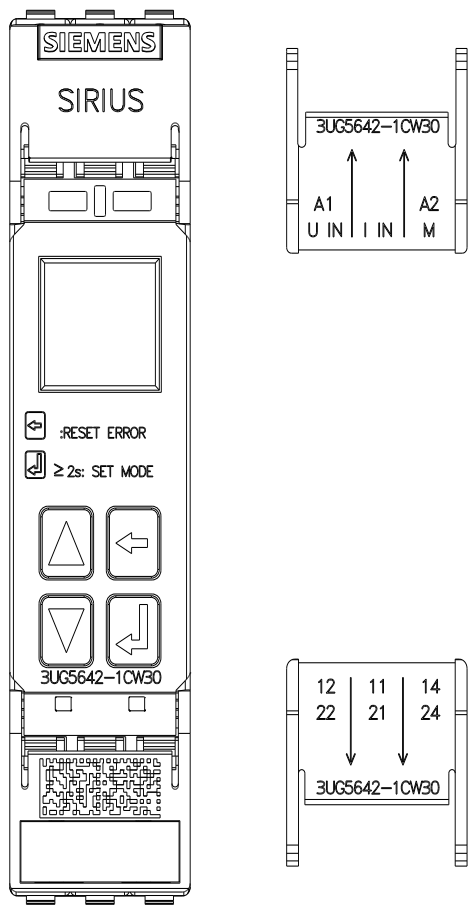
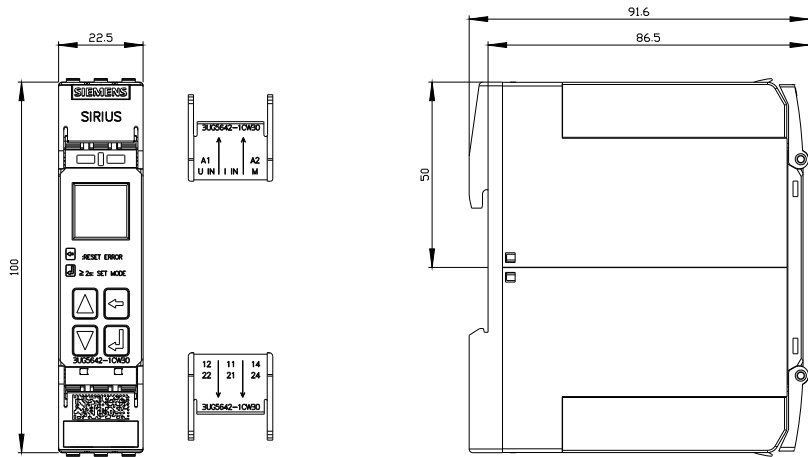

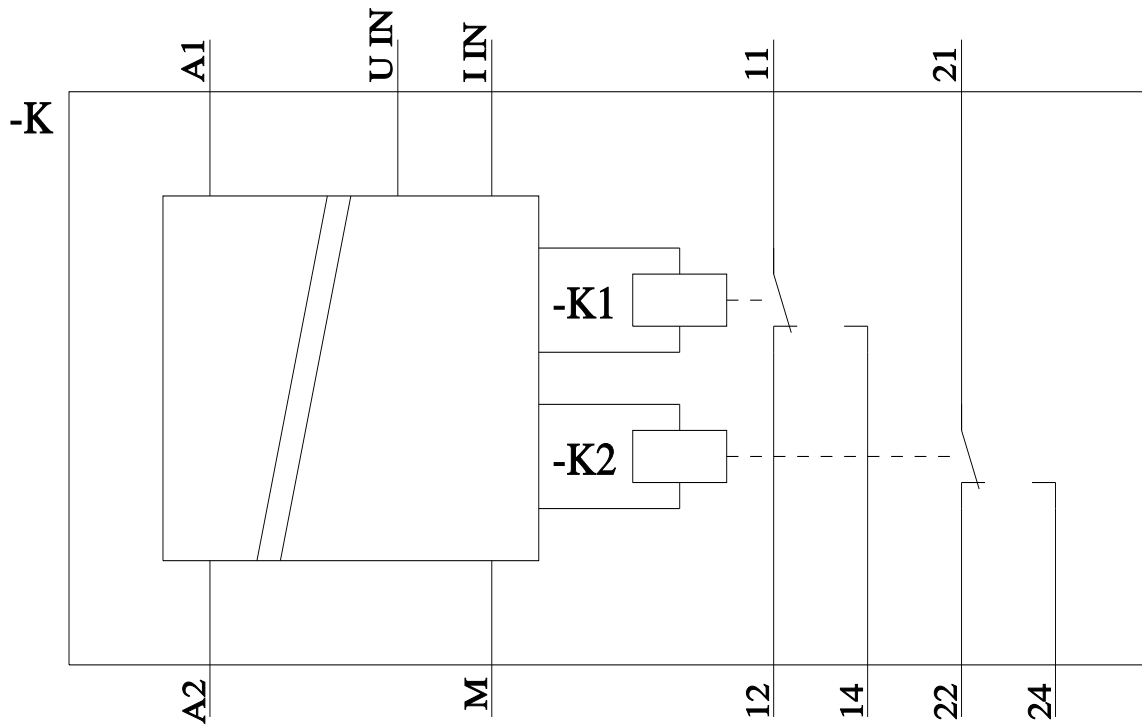

last modified:

8/8/2025 