

Confie o titre de secret d'entreprise. Tous droits réservés.  
 Confiado como secreto industrial. Nos reservamos todos los derechos  
 Comunicado como segredo empresarial. Reservados todos os direitos

Weitergabe sowie Vervielfältigung dieser Unterlage, Verwertung und Mitteilung ihres Inhalts nicht gestattet, soweit nicht ausdrücklich zugestanden. Zuwiderhandlungen verpflichten zu Schadenersatz. Alle Rechte vorbehalten, insbesondere fuer den Fall der Patenterteilung oder Gm-Eintragung.

The reproduction or use of this document or its contents is not permitted without express written authority. Offenders will be liable for damages. All rights, including rights created by patent grant or registration of a utility model or design, are reserved.

Copyright© Siemens AG 2005  
 Cad-drawing; do not make any manual changes

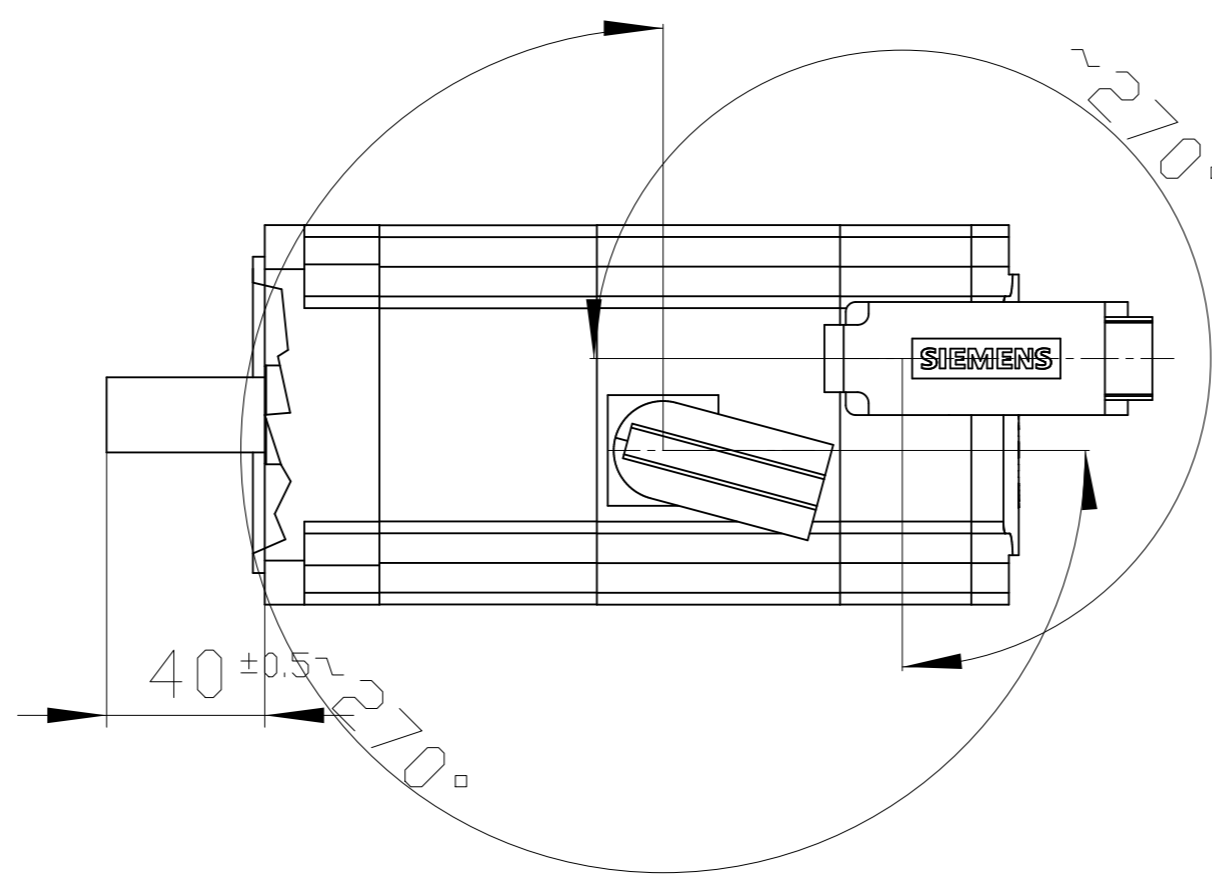
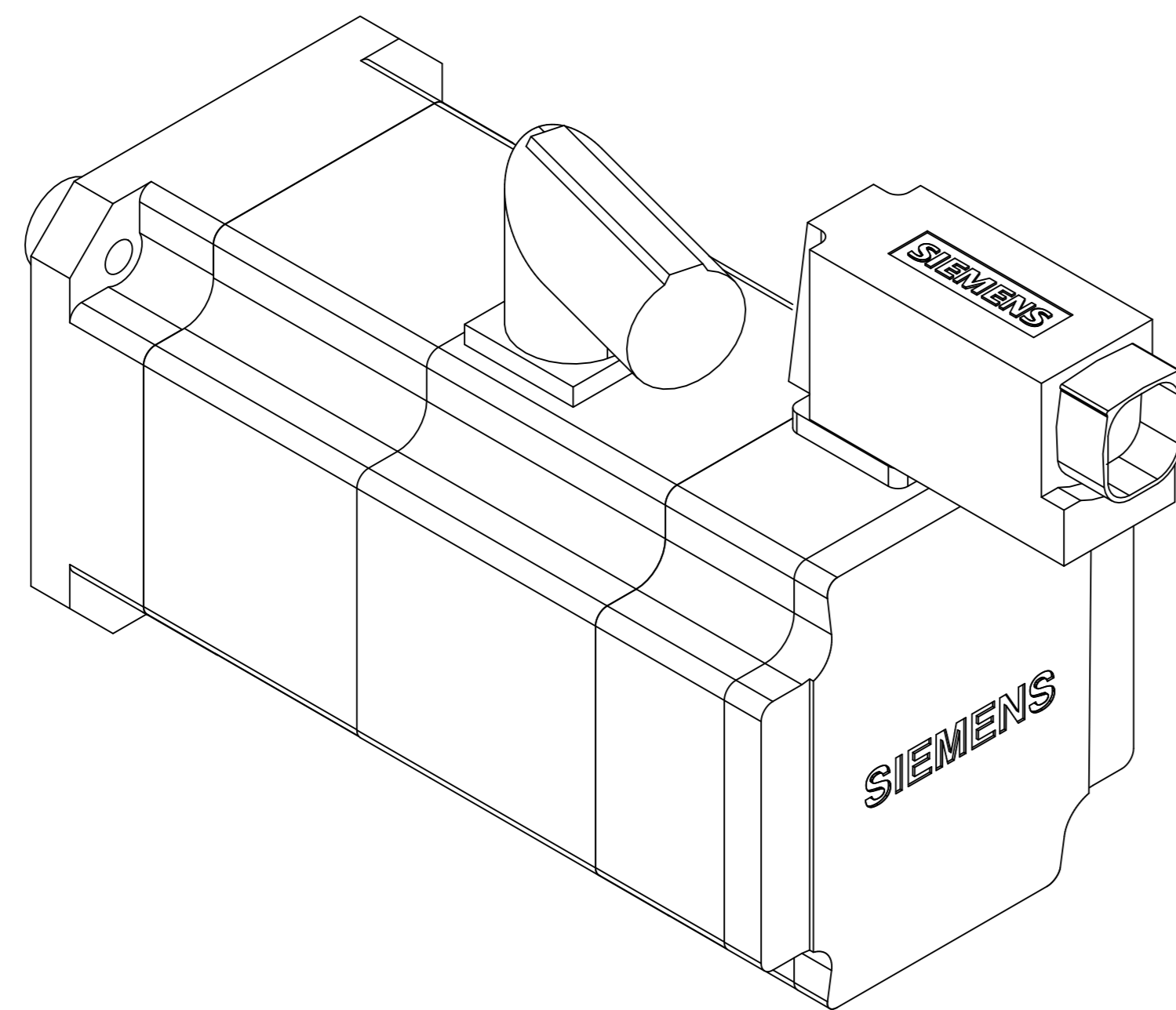
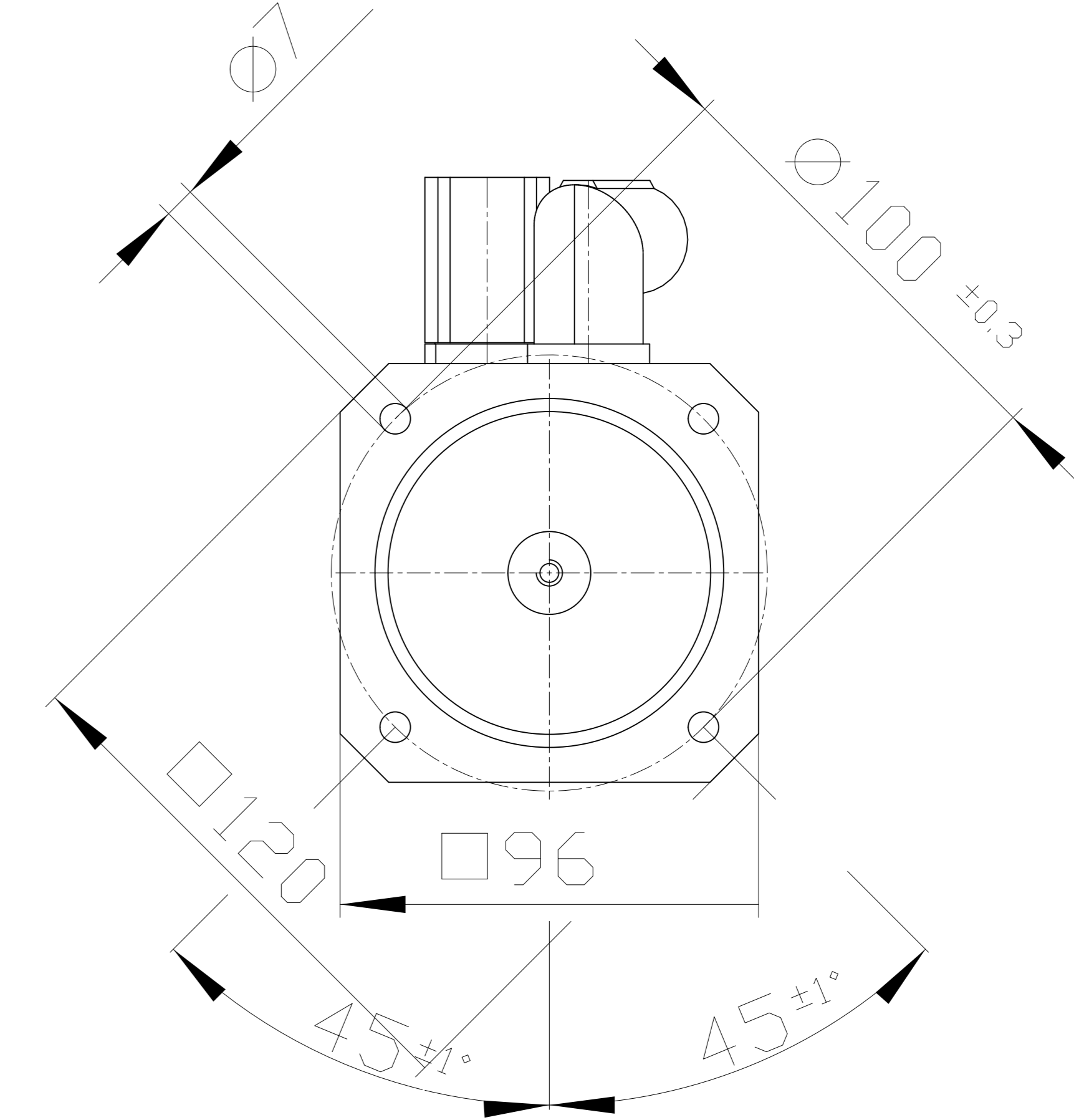
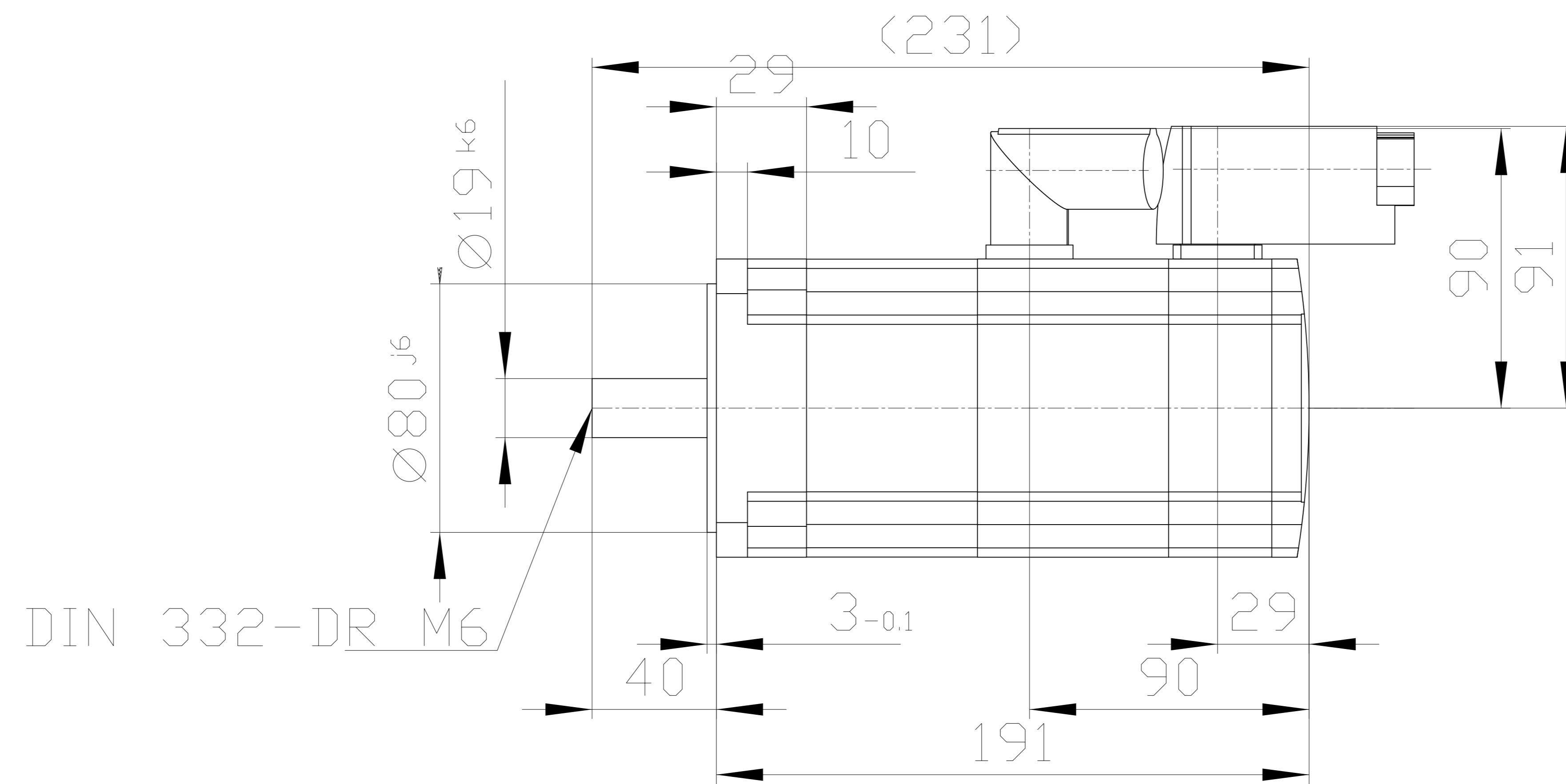
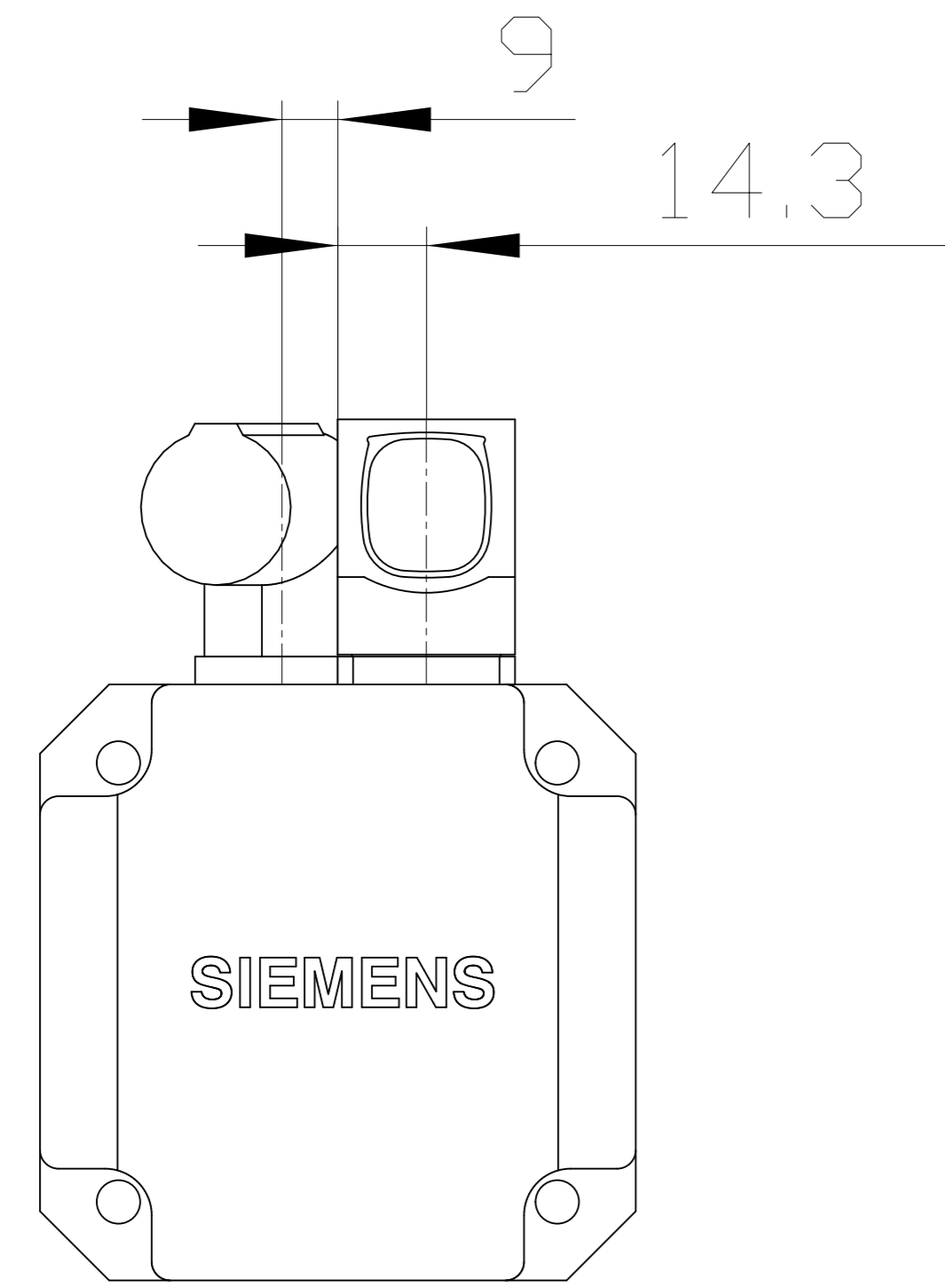

Connector size 1 = M23;  
 6-pole for power and brake

10-pole RJ45 socket

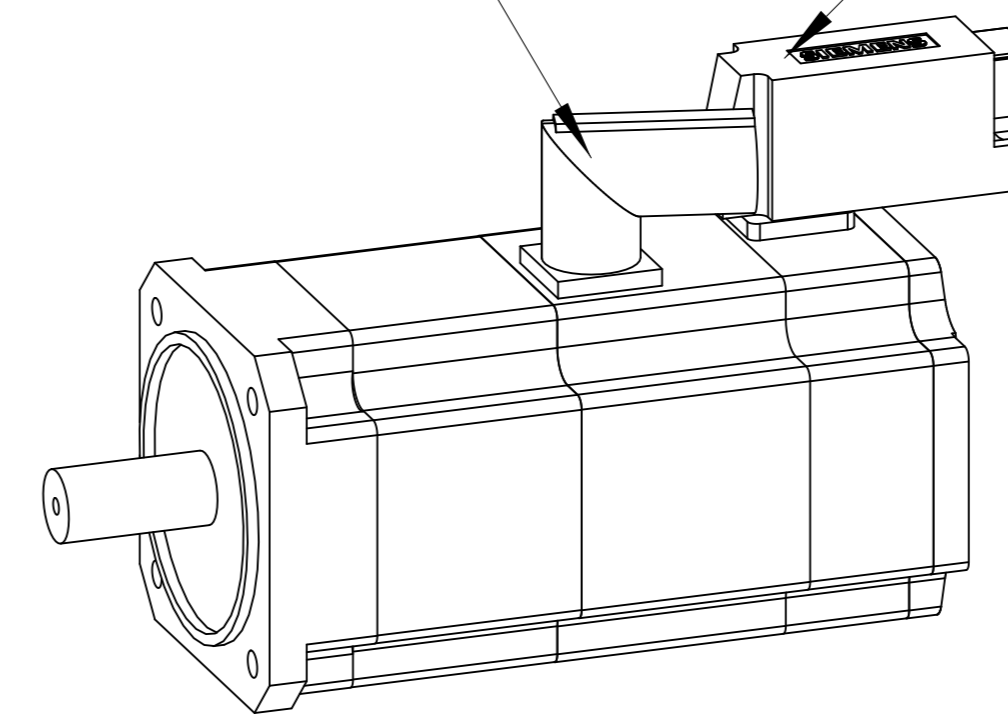

		?ANGEBOT?
		?OPTIONEN?
Unit	mm [in]	1FK7042-5AK71-1UH3
Date	Fri May 17 00:59:34 CEST 2019	
SIEMENS AG		
?GEWICHT?		?APPLICATION?