

Support terminal, green/yellow, screw terminal, for front plate mounting

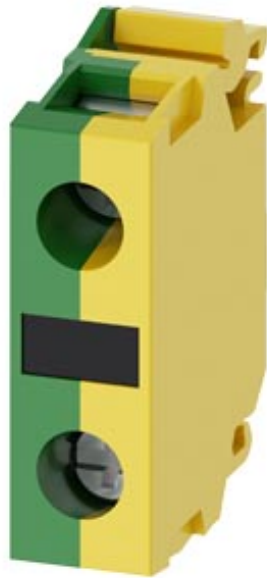

Product brand name	SIRIUS ACT
Product designation	Support terminal
Product type designation	3SU1

General technical data	
Suitability for integration	yes
Degree of pollution	3
Surge voltage resistance rated value	6 kV
Protection class IP	
• of the enclosure	IP40
• of the terminal	IP20
Reference code acc. to DIN EN 81346-2	S
Reference code acc. to DIN EN 61346-2	S

Connections/Terminals	
Type of electrical connection	screw-type terminals
• of modules and accessories	Screw-type terminal

Ambient conditions	
Ambient temperature	
• during operation	-25 ... +70 °C





- during storage

-40 ... +80 °C

### Installation/ mounting/ dimensions

• Mounting type of modules and accessories	Front mounting
(height)	33.2 mm
Width	9.8 mm
Depth	23.4 mm

### Certificates/approvals

General Product Approval	Declaration of Conformity	Test Certificates	Marine / Shipping
 UL	 EAC	 EG-Konf.	 ABS

[Miscellaneous](#)

[Type Test Certificates/Test Report](#)

### Marine / Shipping

### other



LRS



PRS



RINA



RMRS



DNVGL.COM/AF

[Confirmation](#)

### Further information

#### Information- and Downloadcenter (Catalogs, Brochures,...)

<http://www.siemens.com/industrial-controls/catalogs>

#### Industry Mall (Online ordering system)

<https://mall.industry.siemens.com/mall/en/en/Catalog/product?mlfb=3SU1400-1DA43-1AA0>

#### Cax online generator

<http://support.automation.siemens.com/WW/CAXorder/default.aspx?lang=en&mlfb=3SU1400-1DA43-1AA0>

#### Service&Support (Manuals, Certificates, Characteristics, FAQs,...)

<https://support.industry.siemens.com/cs/ww/en/ps/3SU1400-1DA43-1AA0>

#### Image database (product images, 2D dimension drawings, 3D models, device circuit diagrams, EPLAN macros, ...)

[http://www.automation.siemens.com/bilddb/cax\\_de.aspx?mlfb=3SU1400-1DA43-1AA0&lang=en](http://www.automation.siemens.com/bilddb/cax_de.aspx?mlfb=3SU1400-1DA43-1AA0&lang=en)

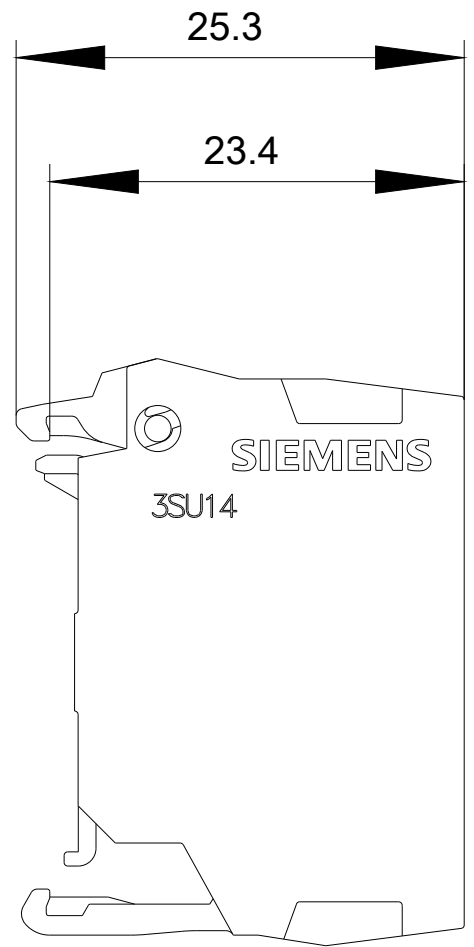
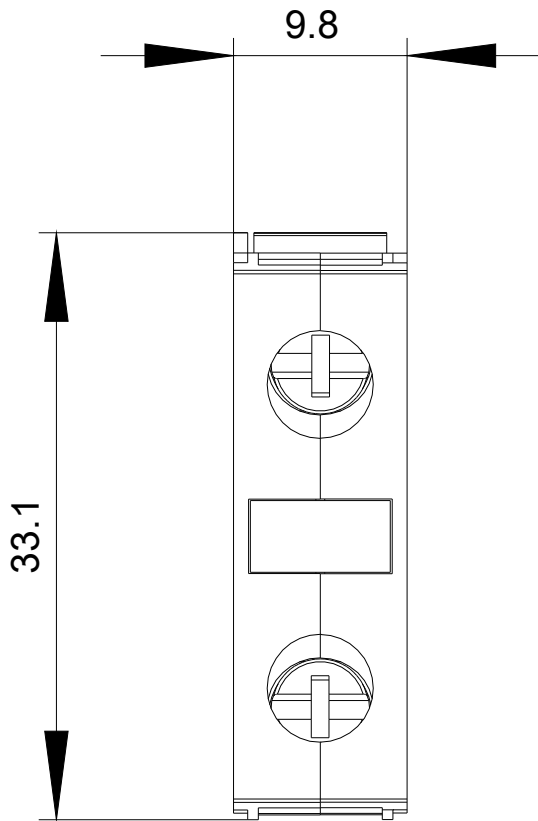

last modified:

07/30/2019