

Copyright © Siemens AG 2005
 Code-drawing do not make any manual changes

The reproduction or use of this document or its contents is not permitted without express written authority. Diffenders will be liable for damages. All rights, including rights created by patent grant or registration of a utility model or design, are reserved.

Weitergabe sowie Vervielfältigung dieser Unterlage, Verwertung und Mitteilung ihres Inhalts nicht gestattet, soweit nicht ausdrücklich zugestanden. Zuwiderhandlungen verpflichten zu Schadenersatz. Alle Rechte vorbehalten, insbesondere fuer den Fall der Patenterteilung oder Gk-Entragung.

Conflicto a titre de secret d'entreprise. Tous droits reserves. Confiado como secreto industrial. No reservamos todos los derechos Comunicado como secreto empresarial. Reservados todos os direitos

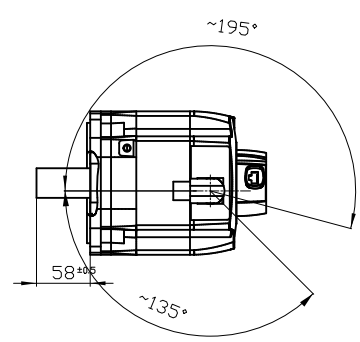
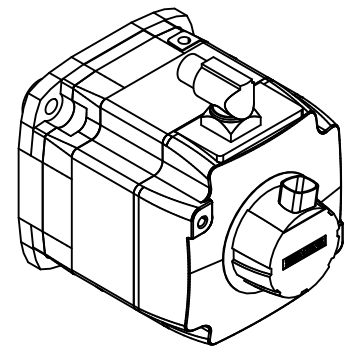
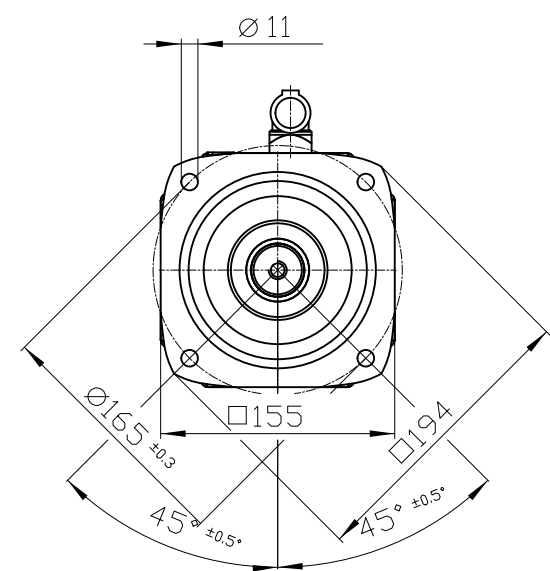
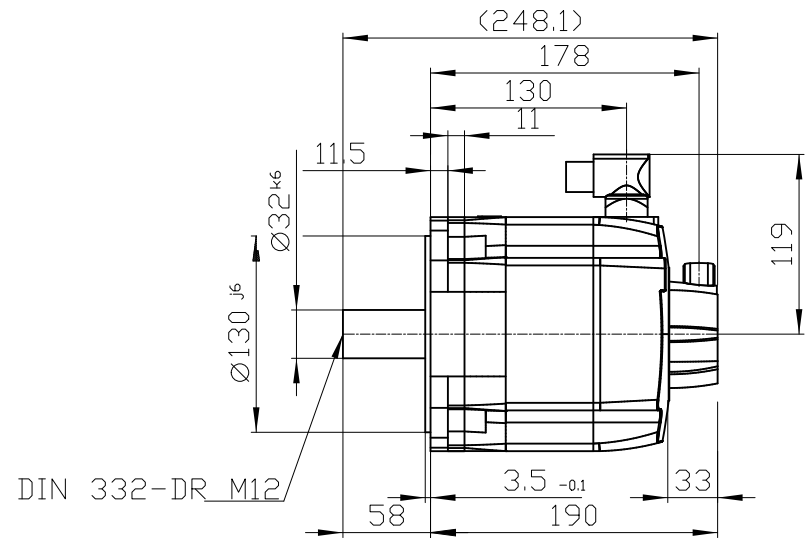
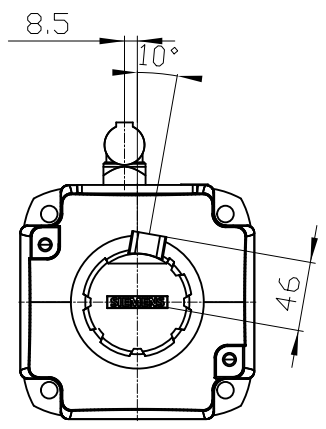

Connector size 1 = M23;
6-pole for power and brake

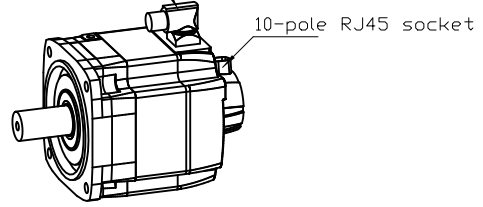

		-
		-
Unit	mm (in)	1FK7081-2AH71-1BG0
Date	2/4/20	
SIEMENS AG		-
		DT