

1

2

3

4

5

6

7

8

back view

front view

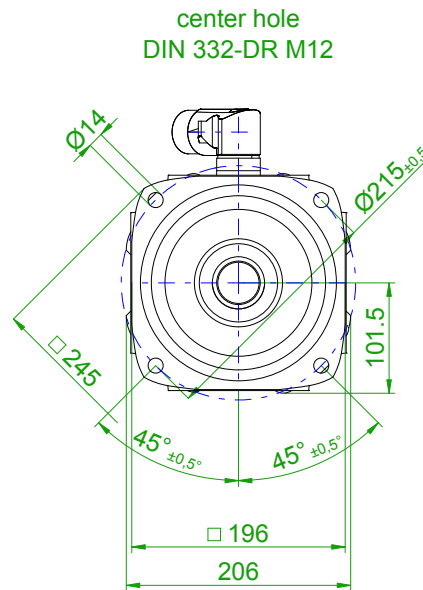
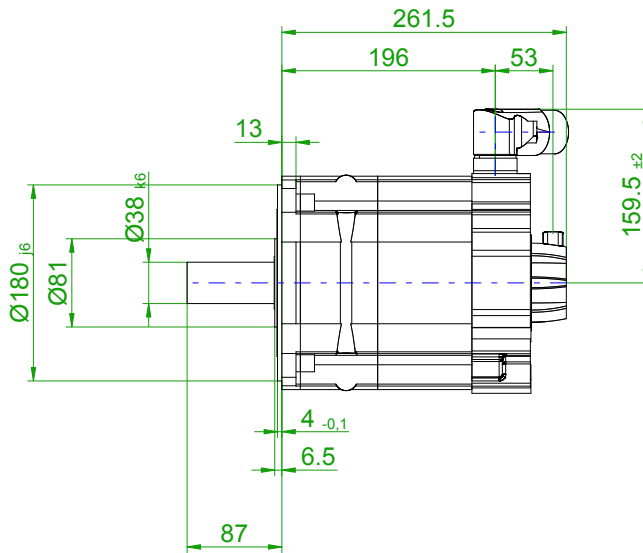
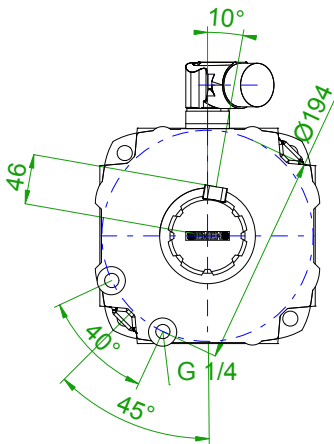

6-pole plug size 1.5 for power

10-pole signal plug

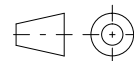
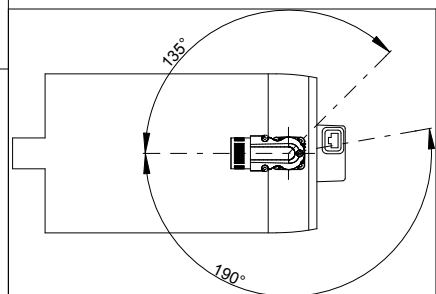
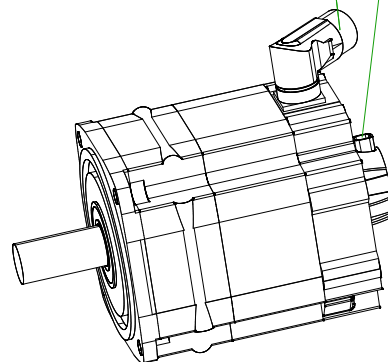
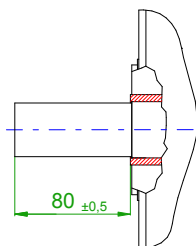

SIEMENS

Einheit / unit: mm

Synchron-Servomotor
Synchronous Servo Motor:

1FT7102-5WF70-1BG3

nicht tolerierte Maße /
not toleranced dimensions: ±1

Optionen / options:

Gewicht / mass:

36.6 kg

Maßstab / scale: ohne / without

Bemerkung / notice:

CAD CREATOR 2.2 (WWW-Version V02.20.00.00)

Druckdatum / print date:

09.09.2019