

Copyright © Siemens AG 2005
 Code-drawing do not make any manual changes
 The reproduction or use of this document or its contents is not permitted without express written authority. Diffenders will be liable for damages. All rights, including rights created by patent grant or registration of a utility model or design, are reserved.
 Weitergabe sowie Vervielfältigung dieser Unterlage, Verwertung und Mitteilung ihres Inhalts nicht gestattet, soweit nicht ausdrücklich zugestanden. Zuwiderhandlungen verpflichten zu Schadenersatz. Alle Rechte vorbehalten, insbesondere fuer den Fall der Patenterteilung oder Gk-Entragung.
 Confiado como secreto industrial. No reservamos todos los derechos. Comunicado como secreto empresarial. Reservados todos os direitos.
 Confié a titre de secret d'entreprise. Tous droits réservés.

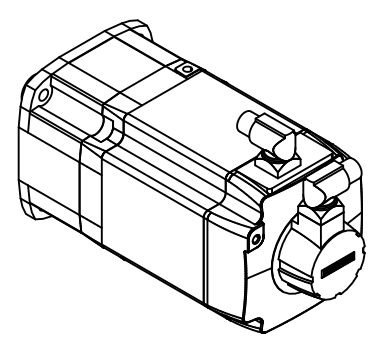

DIN 332-DR M12

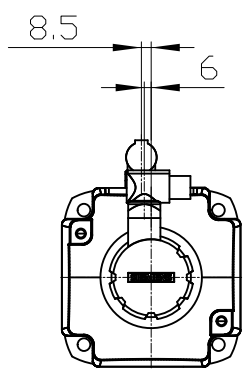
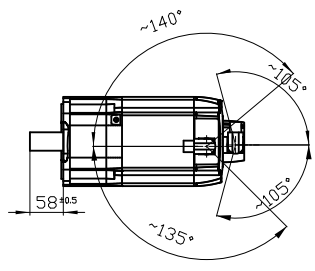
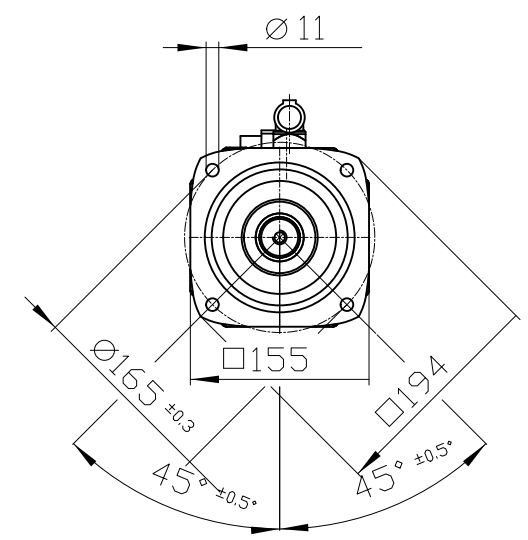
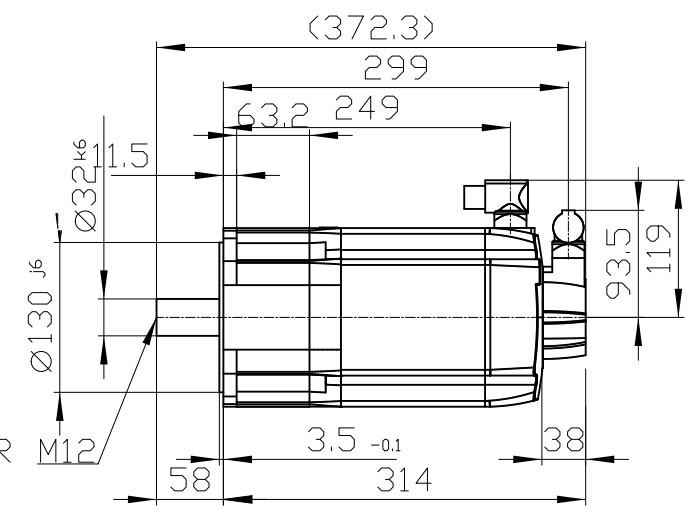

Connector size 1 = M23; 6-pole for power and brake

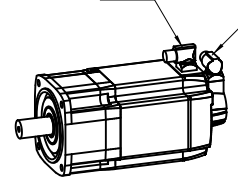

Connector size M23, 17-pole

		-
Unit	mm (in)	1FK7086-4CC71-1EH0
Date	2/4/20	
SIEMENS AG		-
		DT