

Selector switch, illuminable, 30 mm, round, metal, matte, white, selector switch, long, front ring for flush installation, 3 switch positions I-O-II, latching, actuating angle 2x45°, 10:30h/12h/13:30h



Product brand name	SIRIUS ACT
Product designation	Selector switches
Design of the product	Actuating/signaling element
Product type designation	3SU1

Enclosure	
Number of command points	1

Actuator	
Design of the operating mechanism	Selector, long
Manner of function of the actuating element	latching, 2x45° (10:30 h/12 h/13:30 h)
Product extension optional Light source	Yes
Color of the actuating element	White
Material of the actuating element	plastic
Shape of the actuating element	Handle
Outer diameter of the actuating element	44.8 mm
Number of switching positions	3
Actuating angle	
• clockwise	45°
• anticlockwise	45°

Front ring	
Product component front ring	Yes
Design of the front ring	Flat
Material of the front ring	Metal, matt
Color of the front ring	sand gray

General technical data	
Protection class IP	IP66, IP67, IP69(IP69K)
Degree of protection NEMA rating	NEMA 1, 2, 3, 3R, 4, 4X, 12, 13
Shock resistance	<ul style="list-style-type: none"> • acc. to IEC 60068-2-27 • for railway applications acc. to DIN EN 61373
Operating frequency maximum	1 800 1/h
Mechanical service life (switching cycles)	<ul style="list-style-type: none"> • typical
Reference code acc. to DIN EN 81346-2	S
Reference code acc. to DIN EN 61346-2	S

Safety related data	
B10 value	<ul style="list-style-type: none"> • with high demand rate acc. to SN 31920
Proportion of dangerous failures	<ul style="list-style-type: none"> • with low demand rate acc. to SN 31920 • with high demand rate acc. to SN 31920
Failure rate [FIT]	<ul style="list-style-type: none"> • with low demand rate acc. to SN 31920
T1 value for proof test interval or service life acc. to IEC 61508	20 y

Ambient conditions	
Ambient temperature	<ul style="list-style-type: none"> • during operation • during storage
Environmental category during operation acc. to IEC 60721	3M6, 3S2, 3B2, 3C3, 3K6 (with relative air humidity of 10 ... 95 %)

Installation/ mounting/ dimensions	
(height)	44.8 mm
Width	44.8 mm
Shape of the installation opening	round
Mounting diameter	30.5 mm
Positive tolerance of installation diameter	0.5 mm
Mounting height	22.1 mm
Installation width	44.8 mm
Installation depth	32.1 mm

Certificates/approvals

General Product Approval	Declaration of Conformity	Test Certificates
--------------------------	---------------------------	-------------------



CSA



UL



EG-Konf.

[Miscellaneous](#)

[Special Test Certificate](#)

Test Certificates	Marine / Shipping
-------------------	-------------------

[Type Test Certificates/Test Report](#)



ABS



LRS



PRS



RINA



RMRS

Marine / Shipping	other
-------------------	-------



DNVGL.COM/AF

[Confirmation](#)

Further information

Information- and Downloadcenter (Catalogs, Brochures,...)

<http://www.siemens.com/industrial-controls/catalogs>

Industry Mall (Online ordering system)

<https://mall.industry.siemens.com/mall/en/en/Catalog/product?mlfb=3SU1062-2EL60-0AA0>

Cax online generator

<http://support.automation.siemens.com/WW/CAXorder/default.aspx?lang=en&mlfb=3SU1062-2EL60-0AA0>

Service&Support (Manuals, Certificates, Characteristics, FAQs,...)

<https://support.industry.siemens.com/cs/ww/en/ps/3SU1062-2EL60-0AA0>

Image database (product images, 2D dimension drawings, 3D models, device circuit diagrams, EPLAN macros, ...)

http://www.automation.siemens.com/bilddb/cax_de.aspx?mlfb=3SU1062-2EL60-0AA0&lang=en

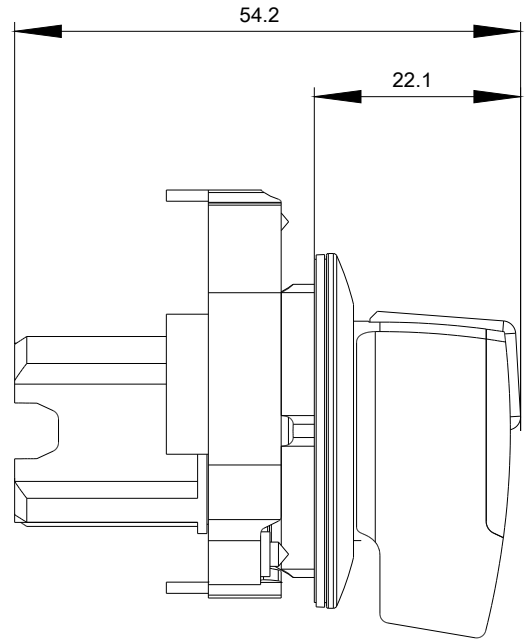
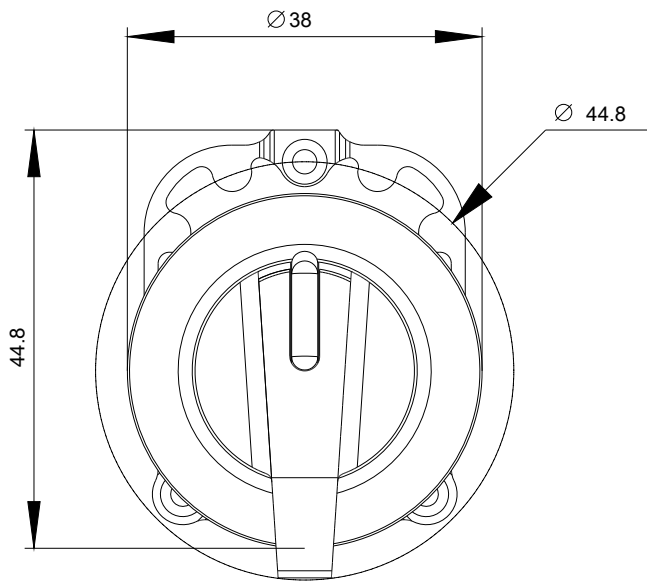

last modified:

07/25/2019