

SIEMENS

Ingenuity for life

TPS3 06

Type 1 / 2 Surge Protection Device (SPD) for Service Entrance Applications – SB1, SB2, SB3, Type RCS Switchboards, Type WL Low Voltage Switchgear, Motor Control Centers and Busway Systems

Features:

- Mounts internal to:
 - SB1, SB2, SB3 & Type RCS switchboards
 - Type WL low voltage switchgear
 - TIASTAR motor control centers - standard 12" bucket
 - STP series busplug on SX series busway
- UL 1449-4 Type 2 SPD, UL 1283 Listed, CSA 22.2 No. 269.2
- Optional UL 1449 4th Edition Recognized Type 1, CSA 22.2 No. 269.1
- Type 1 / Type 2 SPD
- Large block, individually fused, thermally protected, 50 kA MOVs
- 20 kA I_n
- 200 kA SCCR (most models)
- Rotary disconnect switch included
- Designed, manufactured and tested consistent with:
 - ANSI/IEEE C62.41.1-2002, C62.41.2-2002, C62.45-2002, C62.62-2010, C62.72-2016 & CSA C22.2 No. 269.1 and .2
 - 1992/2000 NEMA LS-1
 - NEC Article 285
 - IEC 61643, CE
- All UL required OCP & safety coordination included
 - Type 1 SPDs intended for Line or Load side of Main Disconnect
 - Type 2 SPDs intended for Load side of Main Disconnect

- UL96A Lightning Protection Master Label compliant
- 10 year warranty

SPD Specifications

Surge Current Rating Per Phase

Per Phase	L-N	L-G	N-G
100 kA	50 kA	50 kA	50 kA
150 kA	100 kA	50 kA	50 kA
200 kA	100 kA	100 kA	100 kA
250 kA	150 kA	100 kA	100 kA
300 kA	150 kA	150 kA	150 kA
400 kA	200 kA	200 kA	200 kA
500 kA	250 kA	250 kA	250 kA

- 100% monitoring (Every MOV is monitored, incl. N-G)
- EMI/RFI filtering: Active tracking up to -50 db from 10 kHz to 100 MHz (Type 2 option only, includes UL 1283 Listing)
- Repetitive impulse: 5,000 hits
- $1/2$ nanosecond response time
- Relative humidity range: 1-95% non-condensing
- Operating frequency: 47-63 Hz
- Operating temperature: -25°C (-15°F) to +60°C (140°F)
- Applications
 - Provides main service entrance or downstream protection for sensitive computer and electronic loads
 - Std. redundancy use: 300kA/phase
 - Inc. redundancy use: 450kA/phase
 - Max. redundancy use: 500kA/phase

- SPD Monitoring
 - LED indicators
 - Audible alarm with silence switch and test button
 - Dry contacts
 - Surge counter
 - Rotary disconnect switch



Ordering Information

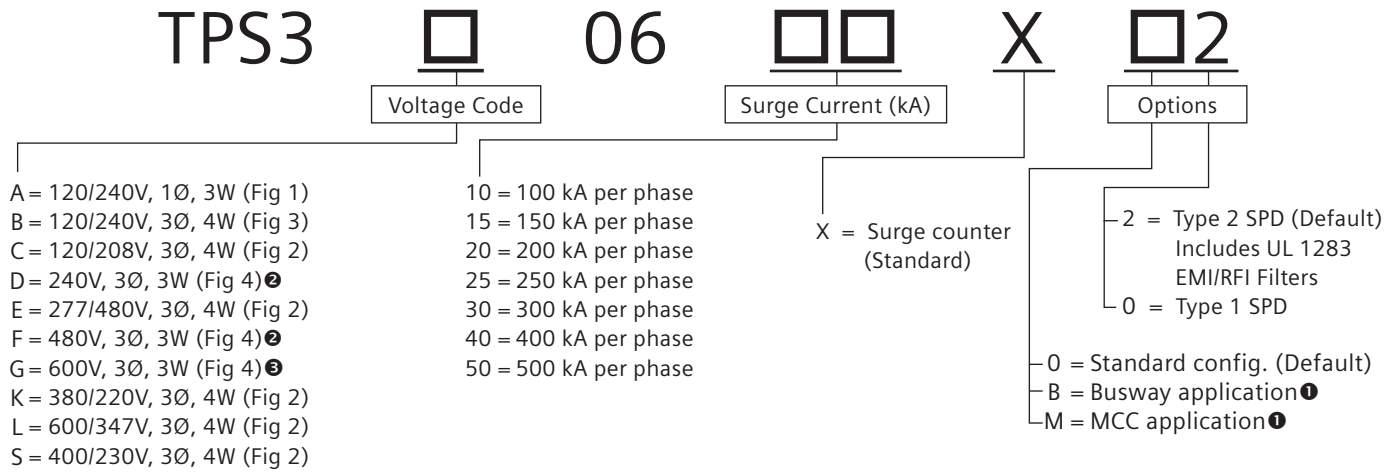

Example: TPS3C0640X002 = Type 2 SPD (Default) for a 208/120V switchboard with a surge current capacity of 400 kA per phase and a surge counter

Available Accessories: Ordered Separately
 RMSIE - Remote monitor
 WHXWDP120 = 10' Display cable extension

UL 1449 Fourth Edition - Test Data Voltage Protection Rating (VPR - 6 kV, 3 kA) ❹

Voltage Code	Service Voltage	L-N	L-G	N-G	L-L	I _n	SCCR	MCOV
A	120/240V, 1Ø, 3W (Fig 1)	700	700	700	1200	20 kA	100 kA	150
B	120/240V, 3Ø, 4W (Fig 3)	700 /1200	700 /1200	700	1800/1800	20 kA	200 kA	150 / 320
C	120/208V, 3Ø, 4W (Fig 2)	700	700	700	1200	20 kA	200 kA	150
D	240V, 3Ø, 3W (Fig 4)	—	1200	—	1200	20 kA	200 kA	320
E	277/480V, 3Ø, 4W (Fig 2)	1200	1200	1200	2000	20 kA	200 kA	320
F	480V, 3Ø, 3W (Fig 4)	—	1800	—	1800	20 kA	200 kA	550
G	600V, 3Ø, 3W (Fig 4)	—	2500	—	2500	20 kA	200 kA	690
K	380/220V, 3Ø, 4W (Fig 2)	1200	1200	1200	2000	20 kA	200 kA	320
L	600/347V, 3Ø, 4W (Fig 2)	1500	1500	1500	2500	20 kA	200 kA	420
S	400/230V, 3Ø, 4W (Fig 2)	1200	1200	1200	2000	20 kA	200 kA	320

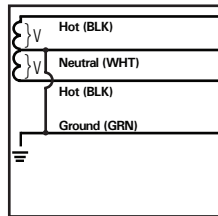

Figure 1
 Split
 2 Hots, 1 Neu, 1 Grnd

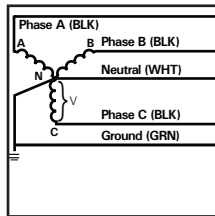

Figure 2
 Wye
 3 Hots, 1 Neu, 1 Grnd

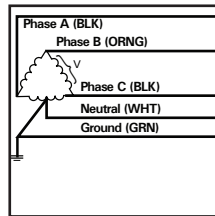

Figure 3
 Hi-Leg Delta (B High)
 3 Hots, (B High),
 1 Neu, 1 Grnd

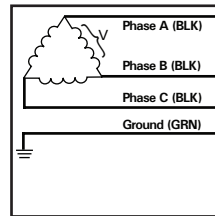

Figure 4
 Delta & HRG Wye
 3 Hots, 1 Grnd

Siemens Industry, Inc.
 5400 Triangle Parkway
 Norcross, GA 30092

888-333-3545
 info.us@siemens.com

Order No. RPFL-S306C-1017
 Printed in USA
 All Rights Reserved.

©2017 Siemens Industry, Inc.

The technical data presented in this document is based on an actual case or on as-designed parameters, and therefore should not be relied upon for any specific application and does not constitute a performance guarantee for any projects. Actual results are dependent on variable conditions. Accordingly, Siemens does not make representations, warranties, or assurances as to the accuracy, currency or completeness of the content contained herein. If requested, we will provide specific technical data or specifications with respect to any customer's particular applications. Our company is constantly involved in engineering and development. For that reason, we reserve the right to modify, at any time, the technology and product specifications contained herein.

Notes:

- ❶ G voltage code only available in 200 & 250 kA
- ❷ Not available in 500 kA
- ❸ Available in 100 kA, 150 kA, 200 kA & 250 kA only
- ❹ VPR may increase when disconnect switch is added
 VPR may decrease for products 400 & 500 kA per phase

CUSTOMER CONNECTIONS PER FIGURES AT LEFT
THREE POLE
TWO POLE

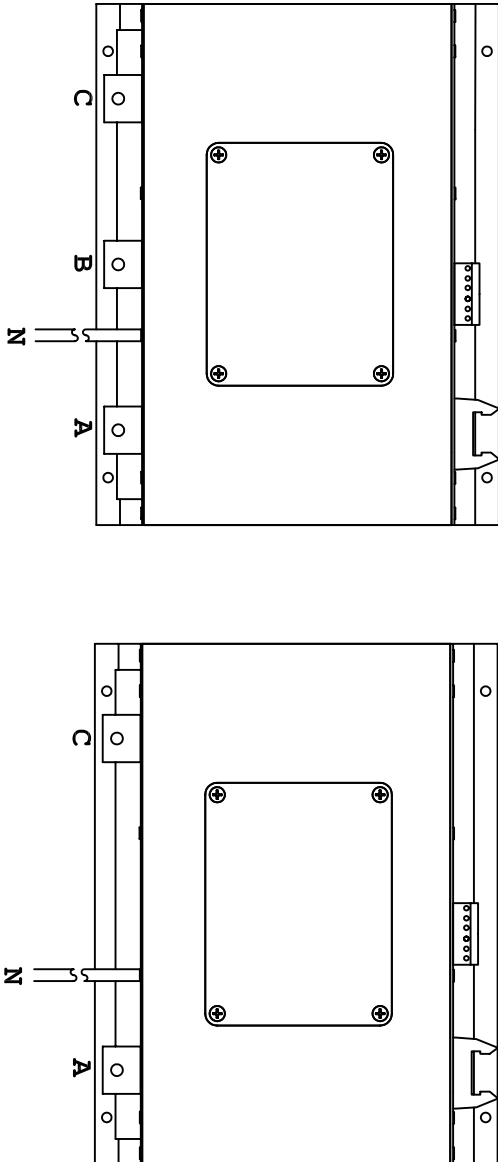
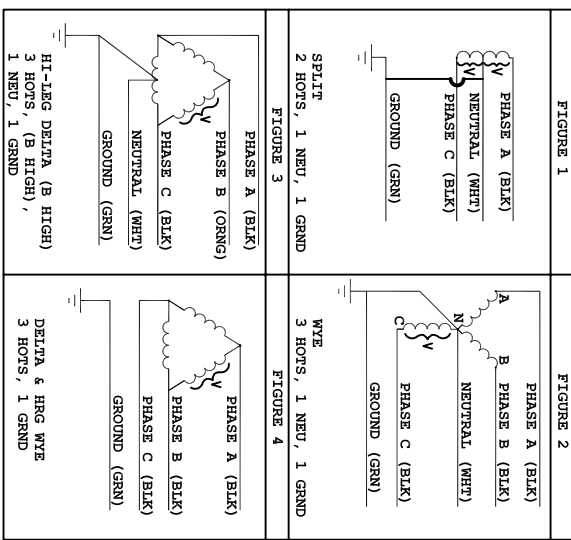

MODEL	VOLTAGE CODE	SERVICE VOLTAGE	FIGURE
TPS3A06/I6	A	240/120V 1Ø, 3W Plus Ground	1
TPS3B06/I6	B	240/120V 3Ø, 4W Plus Ground High Leg Delta	3
TPS3C06/I6	C	208Y/120V 3Ø, 4W Plus Ground	2
TPS3D06	D	240V 3Ø, 3W Plus Ground	2
TPS3E06/I6	E	480Y/277V 3Ø, 4W Plus Ground	4
TPS3F06	F	480V 3Ø, 3W Plus Ground	4
TPS3G06	G	600V 3Ø, 3W Plus Ground	4
TPS3K06/I6	K	380Y/220V 3Ø, 4W Plus Ground	2
TPS3L06	L	600Y/347V 3Ø, 4W Plus Ground	2
TPS3S05/I6	S	400Y/230V 3Ø, 4W Plus Ground	2

Rev	C.N.	Date
△ - Denotes latest changes. □ - Critical dimension.		
DESIGN: H. BROCKERS DRAWN: M.S. APPROVAL: M.S. DATE: 4/7/78		
Confidential - Property of Siemens Industry, Inc. TPS3-06 SERIES ELECTRICAL		SHEET 1 of 1

SURGE PROTECTIVE DEVICE (SPD) WEIGHTS & DIMENSIONS

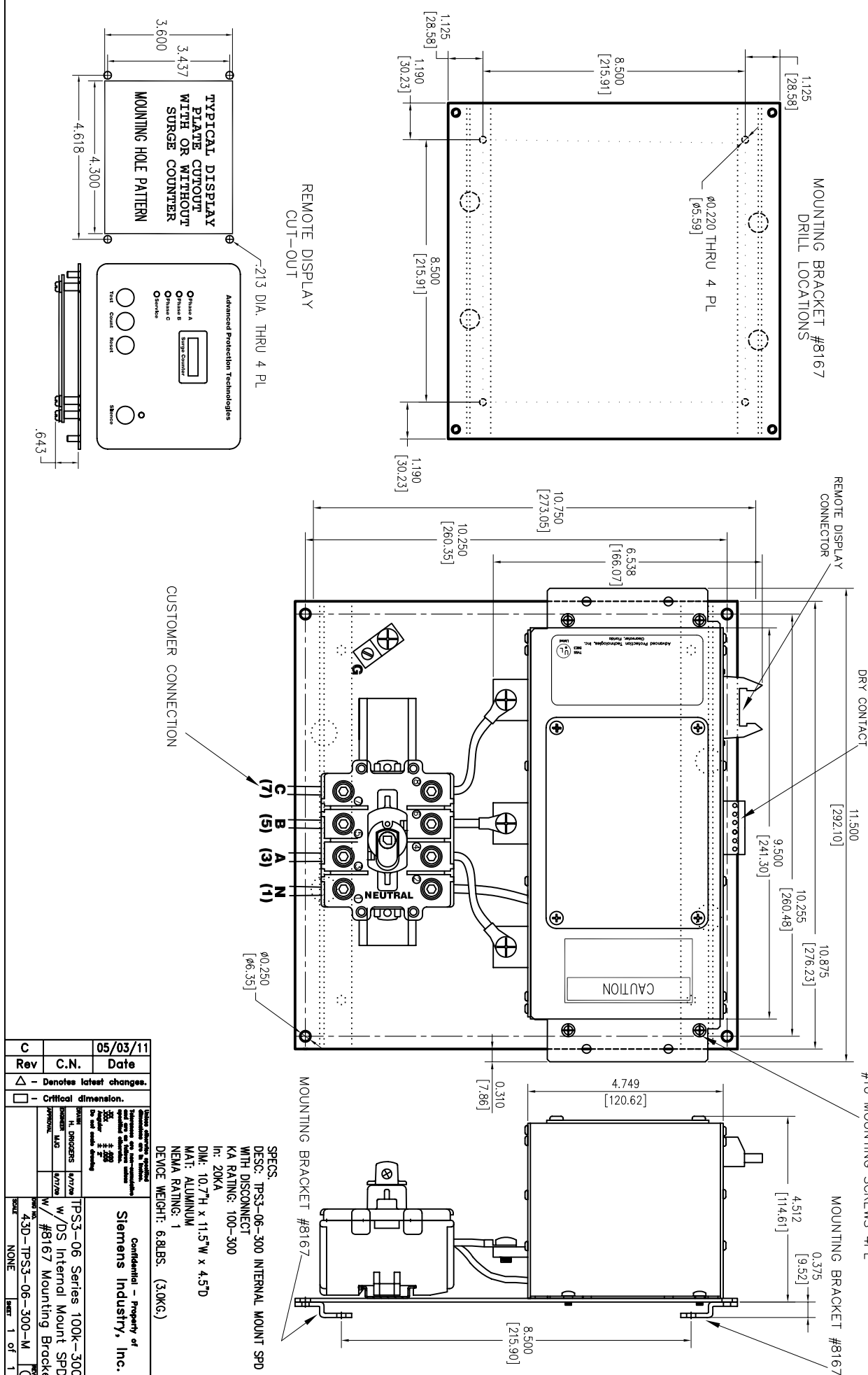

Rev	C.N.	Date
C		05/03/11

▲ - Denotes latest changes.
 □ - Critical dimension.

DESIGNED BY	H. DRINGERS	DATE	4/27/06
CHECKED BY	M.G.	DATE	5/2/06
APPROVED BY		DATE	

CONFIDENTIAL - PROPERTY OF
Siemens Industry, Inc.

SPECS:
 DESC: TPS3-06-300 INTERNAL MOUNT SPD WITH DISCONNECT
 KA RATING: 100-300
 In: 20KA
 DIM: 10.7"H x 11.5"W x 4.5"D
 MAT: ALUMINUM
 NEMA RATING: 1
 DEVICE WEIGHT: 6.8LBS. (3.0KG.)

TPS3-06 Series 100K-300K W/DS Internal Mount SPD W/#8167 Mounting Bracket	REV	C
43D-TPS3-06-300-M	SIZE	NONE
	SHEET	1 of 1

SURGE PROTECTIVE DEVICE (SPD) WEIGHTS & DIMENSIONS

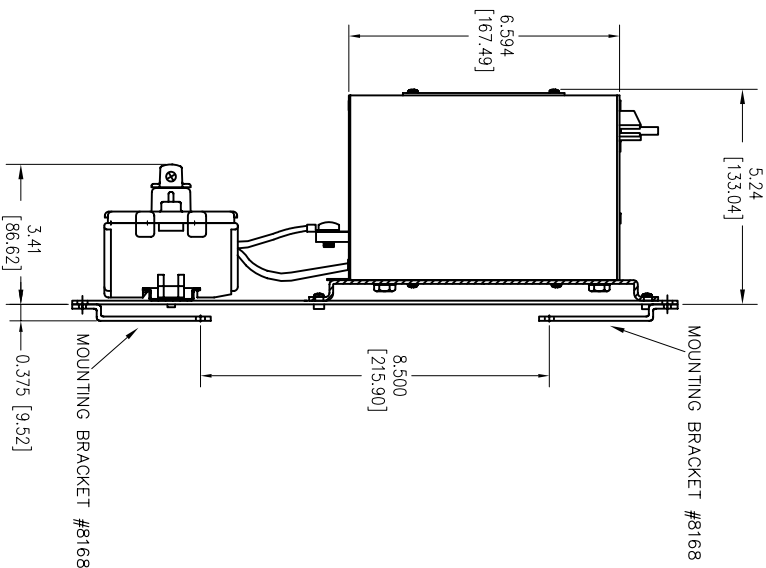
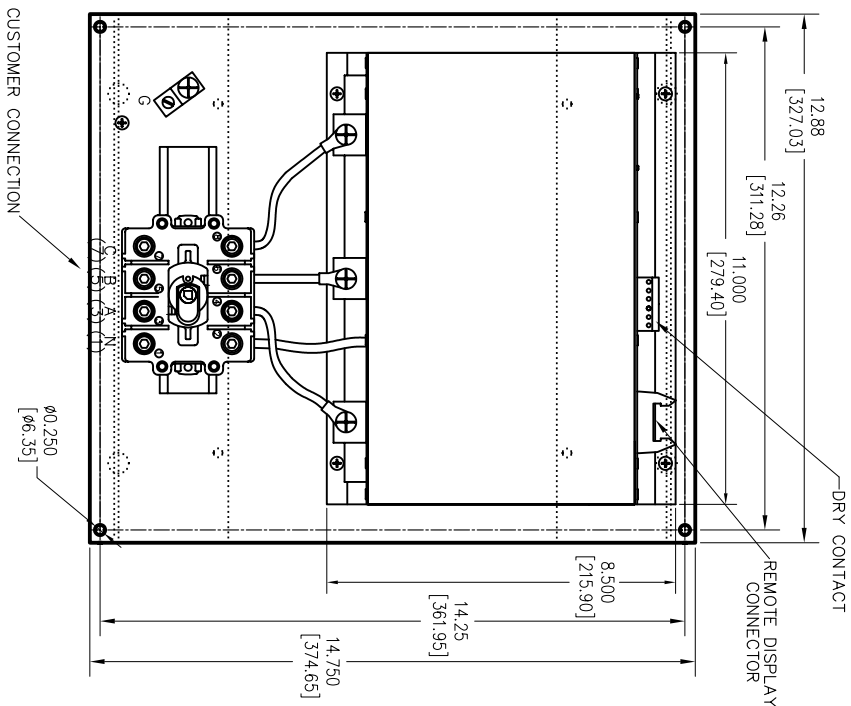
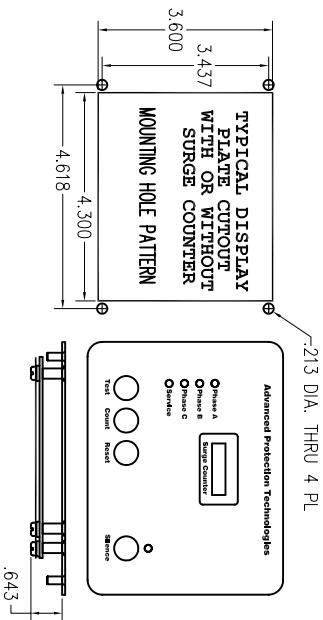
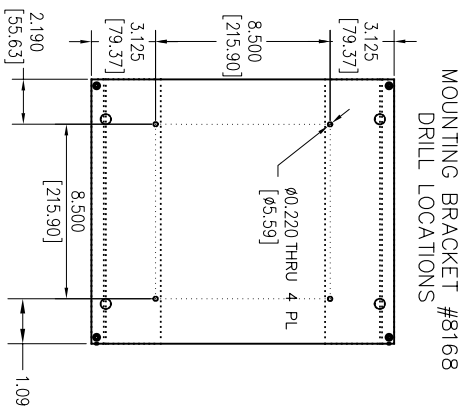

SPCS: TPS3-06-500 INTERNAL MOUNT SPD
 DESG: RSCONNECT
 MFR: MFG-500
 KA RATING: 20K
 IN RATING: 20K
 DIM: 14.71" x 12.8" W x 5.27D
 MAT: ALUMINUM
 NEMA RATING: 1
 DEVICE WEIGHT: 9.6LBS (4.35KG.)

Rev	C.N.	Date
B		3/26/10

△ - Denotes latest changes.
 □ - Critical dimension.

DESIGNED BY	H. DRINGERS	DATE	6/7/08
DRAWN BY	MAG	DATE	6/27/08
CHECKED BY		DATE	
APPROVED BY		DATE	

Confidential - Property of Siemens Industry, Inc.

TPS3-06 Series 400K-500K w/ DS Internal Mount SPD w/ #8168 Mounting Bracket

SCALE: 43D-TPS3-06-500-M [B] NONE

SHEET 1 of 1