

back view

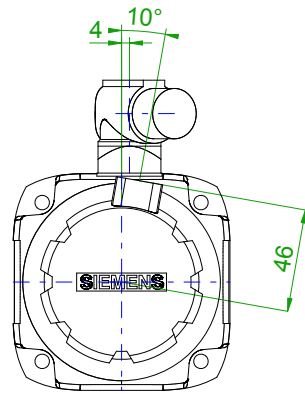

front view

center hole
DIN 332-DR M6

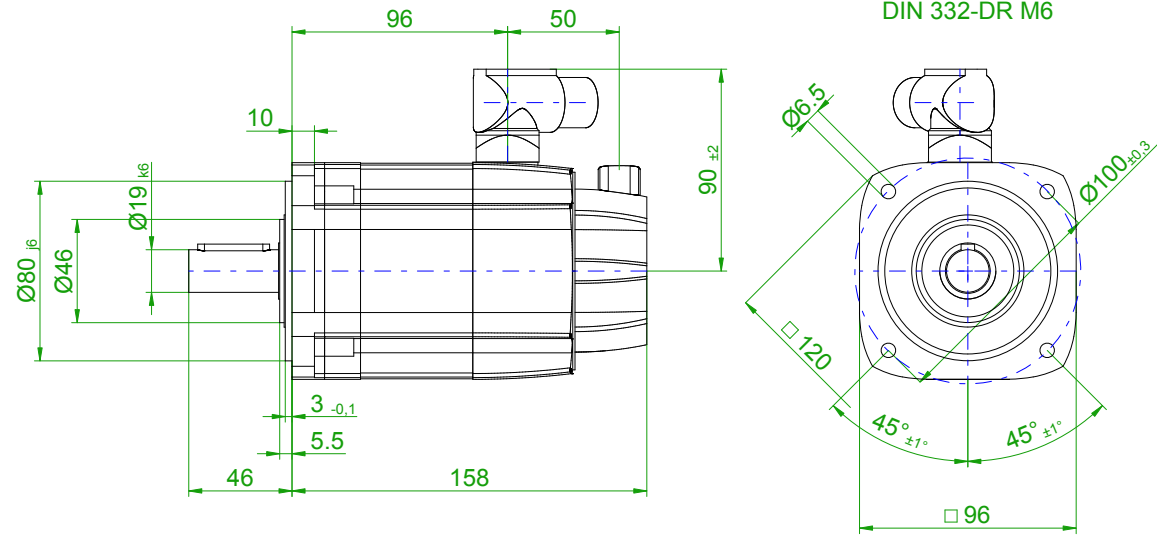

version with featherkey

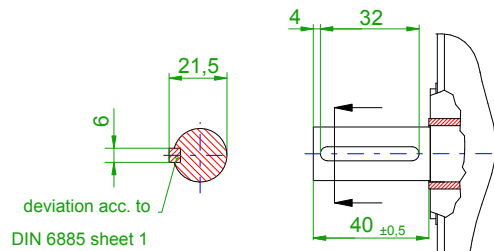

6-pole plug size 1
for power

10-pole
signal plug

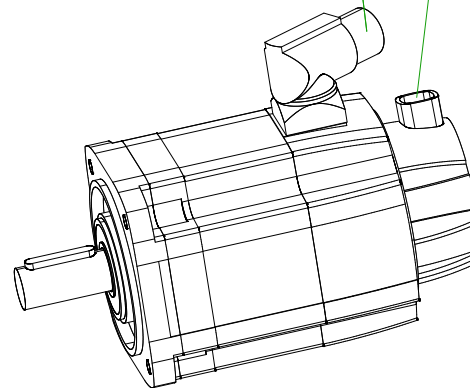

rotating angle of the plug

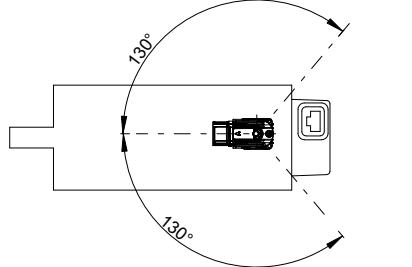

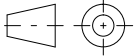
		SIEMENS	
Einheit / unit: mm	Synchron-Servomotor Synchronous Servo Motor:	1FT7042-5AF70-1CA0	
nicht tolerierte Maße / not toleranced dimensions:	Optionen / options:	Gewicht / mass:	4.6 kg
Maßstab / scale: ohne / without	Bemerkung / notice:		
CAD CREATOR 2.2 (WWW-Version V02.20.00.00)	Druckdatum / print date:	29.04.2019	