

1

2

3

4

5

6

7

8

back view

front view

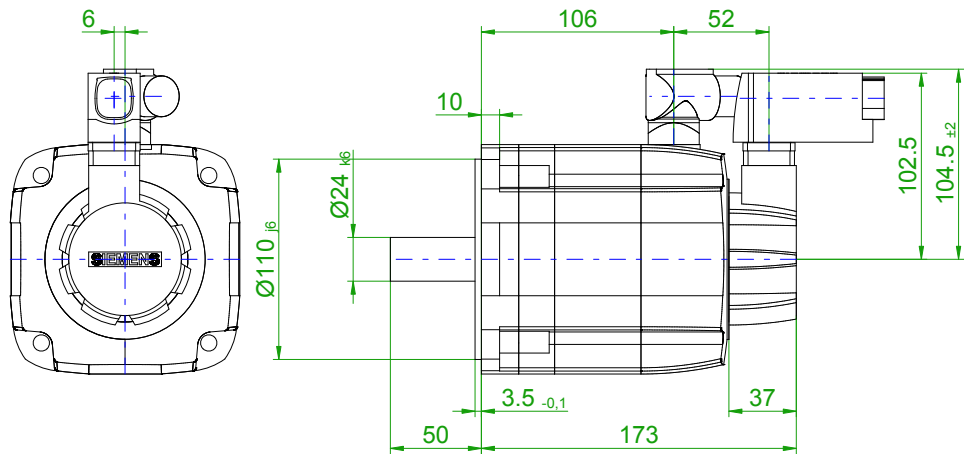

center hole  
DIN 332-DR M8

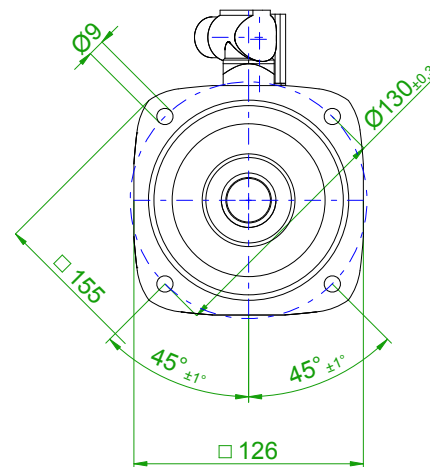

6-pole plug size 1  
for power

10-pole  
signal plug

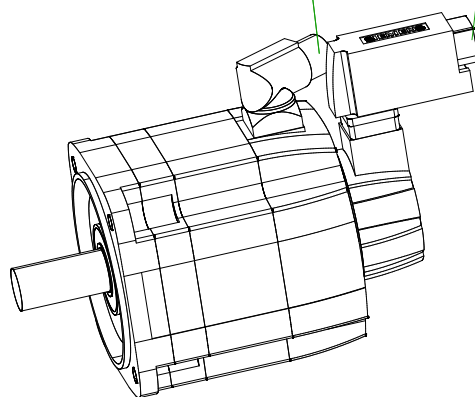
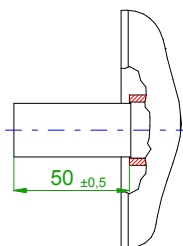

rotating angle of the plug

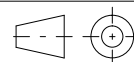
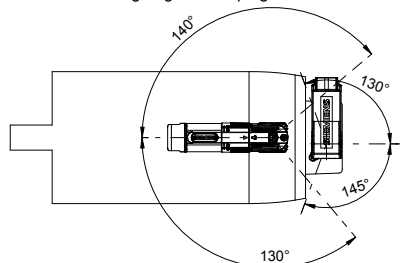

**SIEMENS**

Einheit / unit: mm

Synchron-Servomotor  
Synchronous Servo Motor:

1FT7062-1AF71-1DG1

nicht tolerierte Maße /  
not toleranced dimensions:

±1

Optionen / options:

Gewicht / mass:

7.1 kg

Maßstab / scale: ohne / without

Bemerkung / notice:

CAD CREATOR 2.2 (WWW-Version V02.20.00.00)

Druckdatum / print date:

20.09.2018